

CP6712-0000-0040

main dimensions and
fixing points

dimensions in mm

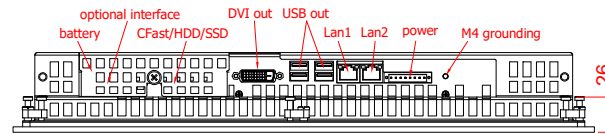

bottom view

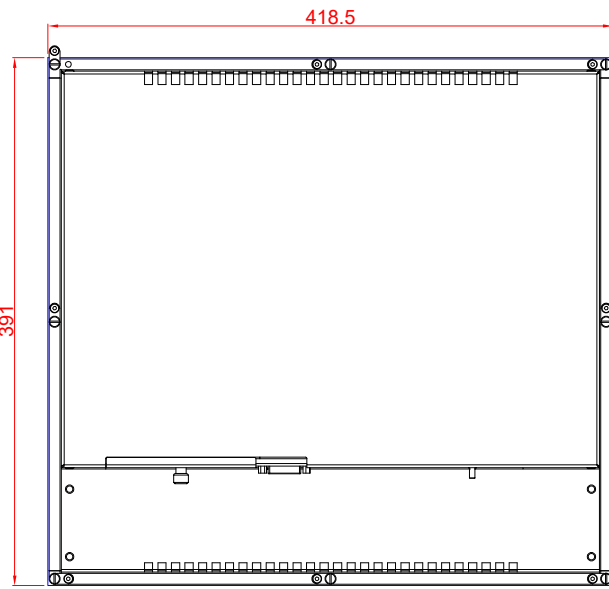

cut out dimensions: 391mm x 418.5mm

rear view

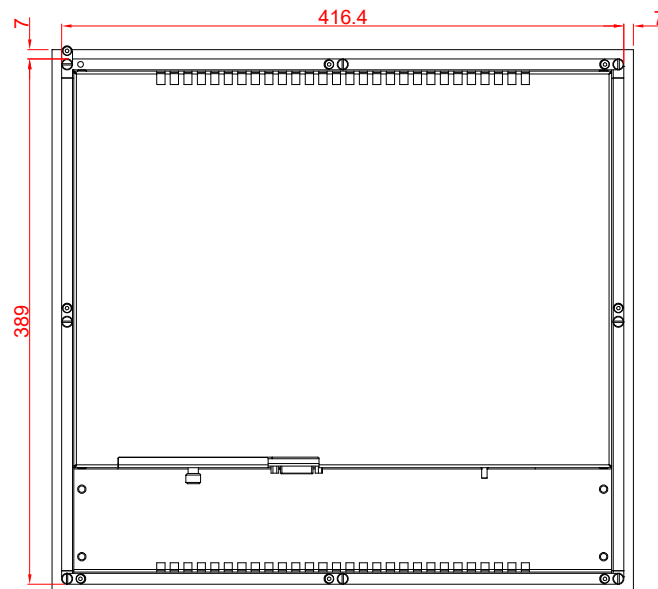

rear view

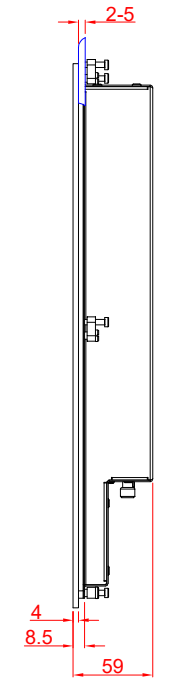

side view

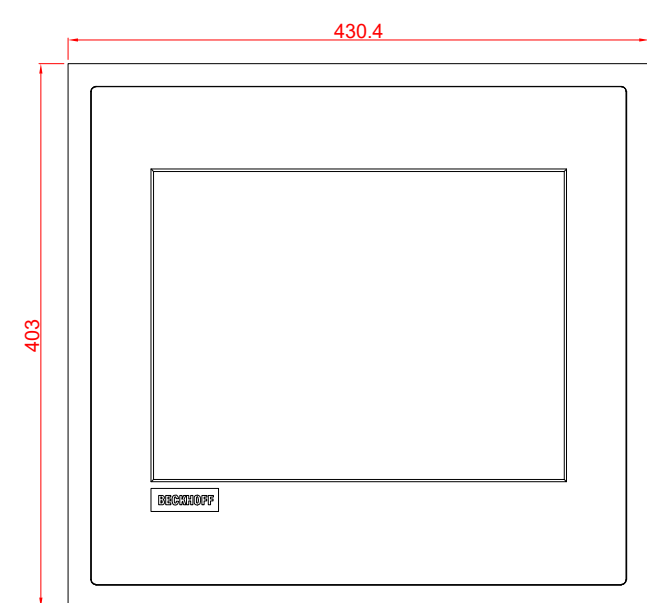

front view