

CP3218-M184-E281

main dimensions and
fixing points

dimensions in mm

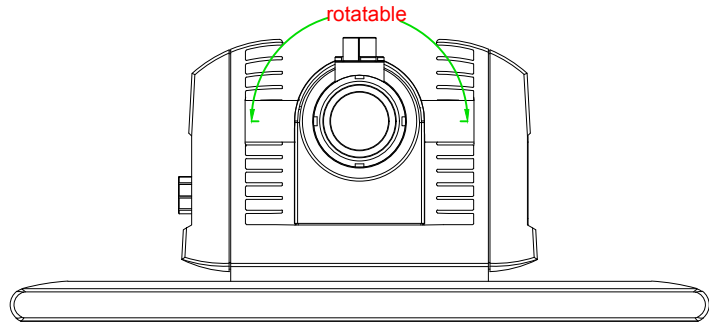

bottom view

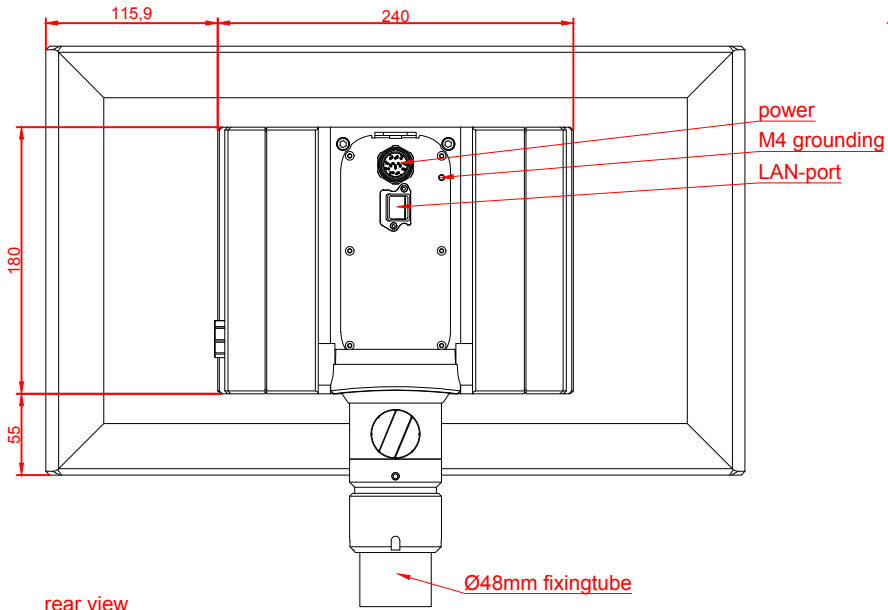
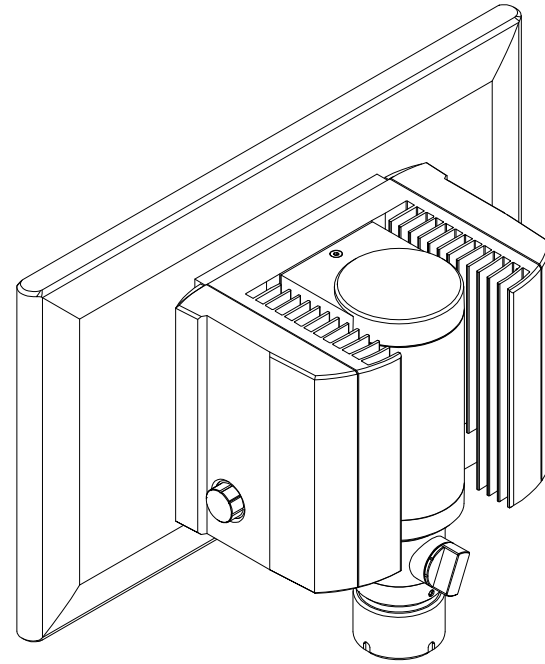

rear view

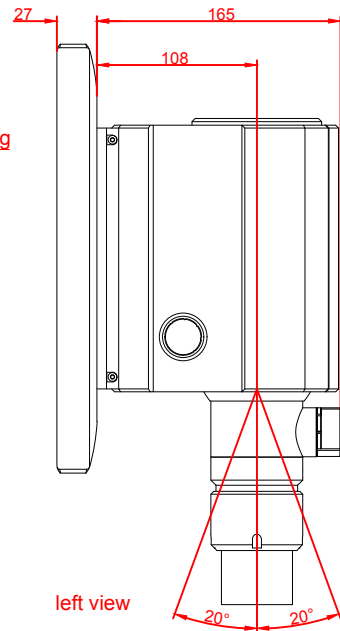

left view

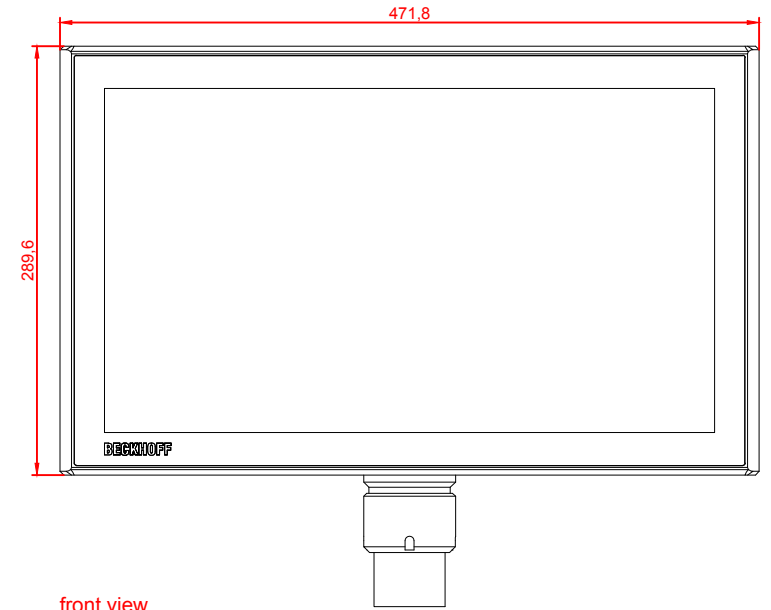

front view