

front view

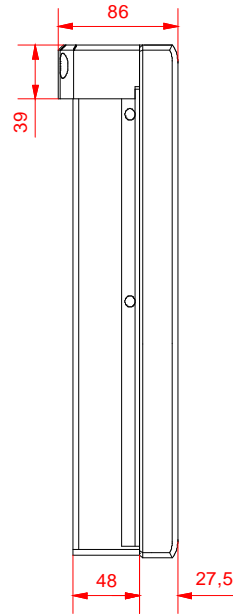

left view

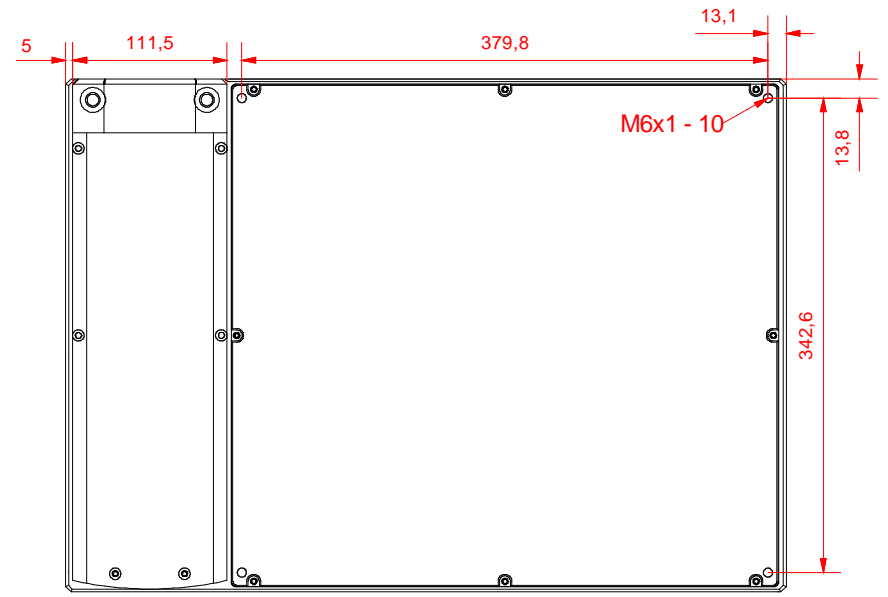

rear view

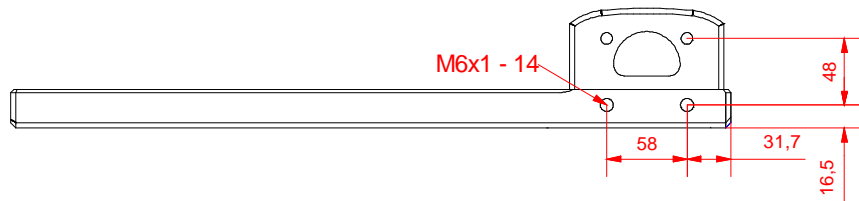

top view

CP 7037 - 0001 - E626

arm adapter for  
Rolec - Tara - suspension adaption  
146.025.019

main dimensions and  
fixing points

dimensions in mm

