

CP3915-0000
with
C9900-M390

main dimensions and
fixing points

dimensions in mm

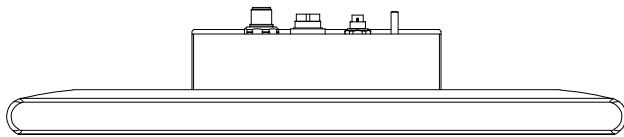

bottom view

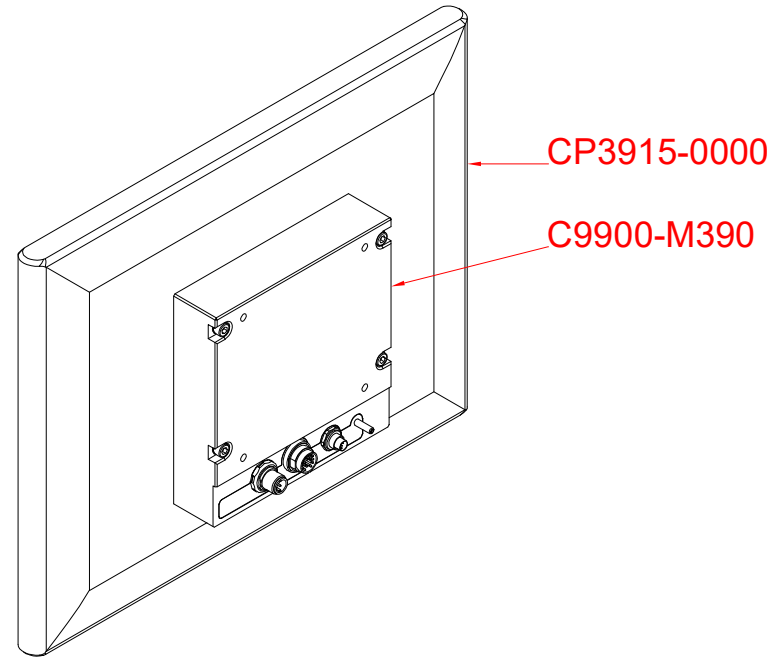

CP3915-0000

C9900-M390

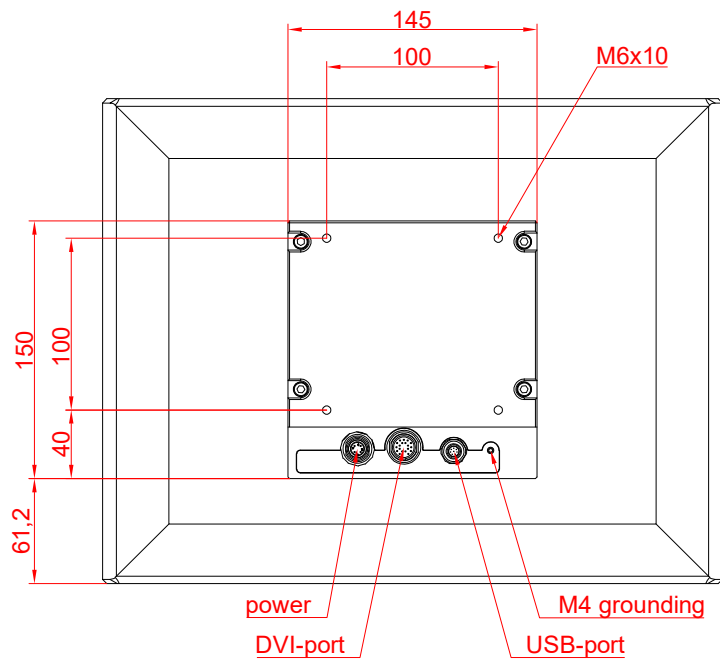

rear view

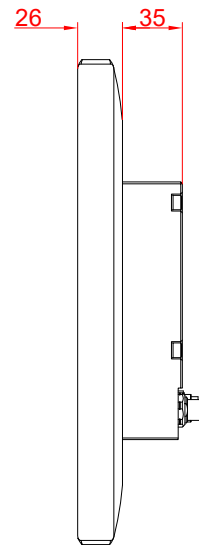

side view

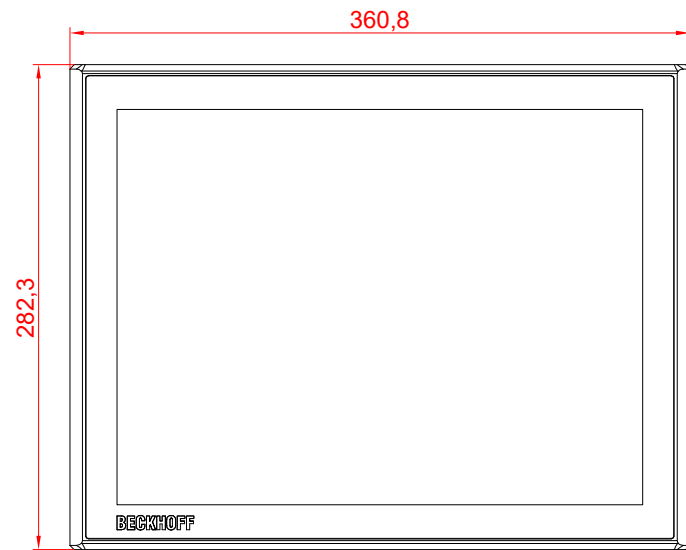

front view