

**BECKHOFF** New Automation Technology

Installation and operating instructions | EN

CPX37xx-0010

Multi-touch Panel PC for use in hazardous locations, zone 2





# Table of Contents

<b>1</b>	<b>Notes on the documentation</b>	<b>5</b>
1.1	Explanation of symbols	6
<b>2</b>	<b>For your safety</b>	<b>7</b>
2.1	Intended use	7
2.2	Notes about operation in potentially explosive areas	8
2.2.1	Special conditions (ATEX)	8
2.2.2	Special conditions (IECEX)	9
2.2.3	Marking	10
2.3	Safety instructions	11
2.4	Staff qualification	12
2.5	Operator's responsibility	12
<b>3</b>	<b>Transport and storage</b>	<b>13</b>
<b>4</b>	<b>Product overview</b>	<b>14</b>
4.1	Access to the interfaces	15
4.2	Name plate	16
4.3	Description of the interfaces	17
4.3.1	Power supply (X101)	17
4.3.2	LAN1, LAN2 (X104, X105)	18
4.3.3	USB output (X102, X103)	18
4.3.4	Ground	18
4.3.5	Access to the battery and the CFast card slot	19
<b>5</b>	<b>Mounting and wiring</b>	<b>21</b>
5.1	Mounting	21
5.1.1	Preparation of the Panel PC	21
5.1.2	Mounting the mounting arm tube	23
5.1.3	Mounting arm adapter (Optional C9900-M763)	23
5.2	Wiring	25
5.2.1	Preparation and protective earthing	25
5.2.2	Connecting	26
5.2.3	Fitting the power supply	27
<b>6</b>	<b>Operation</b>	<b>28</b>
6.1	Switching the Panel PC on and off	28
6.2	Touch screen	28
6.3	Servicing and maintenance	29
6.4	Emergency procedures	29
6.5	Shutting down	29
<b>7</b>	<b>Troubleshooting</b>	<b>30</b>
<b>8</b>	<b>Assembly dimensions</b>	<b>31</b>
<b>9</b>	<b>Technical Data</b>	<b>34</b>
<b>10</b>	<b>Appendix</b>	<b>35</b>
10.1	Standards reference for explosive atmospheres	35
10.2	Approvals for USA and Canada	36

---

10.3 Connection Kits/ Connecting Cables/ Accessories .....	37
10.4 Support and Service.....	38

# 1 Notes on the documentation

This description is only intended for the use of trained specialists in control and automation engineering who are familiar with the applicable national standards.

It is essential that the documentation and the following notes and explanations are followed when installing and commissioning the components.

It is the duty of the technical personnel to use the documentation published at the respective time of each installation and commissioning.

The responsible staff must ensure that the application or use of the products described satisfy all the requirements for safety, including all the relevant laws, regulations, guidelines and standards.

## Disclaimer

The documentation has been prepared with care. The products described are, however, constantly under development.

We reserve the right to revise and change the documentation at any time and without prior announcement.

No claims for the modification of products that have already been supplied may be made on the basis of the data, diagrams and descriptions in this documentation.

## Trademarks

Beckhoff®, TwinCAT®, EtherCAT®, Safety over EtherCAT®, TwinSAFE®, XFC® and XTS® are registered trademarks of and licensed by Beckhoff Automation GmbH.

Other designations used in this publication may be trademarks whose use by third parties for their own purposes could violate the rights of the owners.

## Patent Pending

The EtherCAT Technology is covered, including but not limited to the following patent applications and patents:

EP1590927, EP1789857, DE102004044764, DE102007017835

with corresponding applications or registrations in various other countries.

The TwinCAT Technology is covered, including but not limited to the following patent applications and patents:

EP0851348, US6167425 with corresponding applications or registrations in various other countries.

**EtherCAT** 

EtherCAT® is registered trademark and patented technology, licensed by Beckhoff Automation GmbH, Germany

## Copyright

© Beckhoff Automation GmbH & Co. KG, Germany.

The reproduction, distribution and utilization of this document as well as the communication of its contents to others without express authorization are prohibited.

Offenders will be held liable for the payment of damages. All rights reserved in the event of the grant of a patent, utility model or design.

## 1.1 Explanation of symbols

The following symbols with corresponding warnings or explanatory text are used in the documentation. Read and follow the warnings.

### Symbols that warn of personal injury:

#### **DANGER**

##### **Serious risk of injury**

Note this warning. Hazard with high risk of death or serious injury.

#### **WARNING**

##### **Risk of injury**

Note this warning. Hazard with medium risk of death or serious injury.

#### **CAUTION**

##### **Personal injuries**

Note this warning. Hazard with a low degree of risk, which could lead to minor or moderate injury.

### Symbols that warn of damage to property or equipment:

#### **NOTICE**

##### **Damage to the devices or environment**

Note this warning. Risk of damage to the environment and equipment.

### Symbols indicating further information or tips:



#### **Tip or pointer**

This symbol indicates information that contributes to better understanding.

## 2 For your safety

Read the chapter on safety and follow the instructions in order to protect from personal injury and damage to equipment.

### Limitation of liability

All the components are supplied in particular hardware and software configurations appropriate for the application. Unauthorized modifications and changes to the hardware or software configuration, which go beyond the documented options, are prohibited and nullify the liability of Beckhoff Automation GmbH & Co. KG.

In addition, the following actions are excluded from the liability of Beckhoff Automation GmbH & Co. KG:

- Failure to comply with this documentation.
- Improper use.
- Untrained personnel.
- Use of unauthorized replacement parts.

## 2.1 Intended use

The Panel PC CPX37xx is designed for industrial application in machine and plant engineering. The Panel PC is intended for mounting arm installation either via 100x100 mm mounting interface or optional available mounting arm adapter for mounting arm systems with 48mm tube (C9900-M763).

The Panel PC has no sparking components and is designed for a working environment that meets the requirements of protection class IP 65.

The specified limits for electrical and technical data must be adhered to.

### Potentially explosive atmospheres

The Panel PC is only suitable for zone 2 areas in which gas is present as a combustible material. Zone 2 means that an explosive atmosphere does usually not occur during normal operation, or only for a short time.

### Improper use

The Panel PC is not suitable for operation in the following areas:

- The Panel PC must not be used in other zones except for 2.
- Areas with an aggressive environment, e.g. aggressive gases or chemicals.
- Living areas. In living areas, the relevant standards and guidelines for interference emissions must be adhered to, and the devices must be installed in housings or control cabinets with suitable shielding.

## 2.2 Notes about operation in potentially explosive areas

### 2.2.1 Special conditions (ATEX)

#### **WARNING**

##### **Danger of explosion**

Gases can be ignited in potentially explosive areas. Read and follow the safety instructions to prevent deflagration or explosions.

Provisions shall be made to prevent the rated voltage from being exceeded by transient disturbances of more than 119 V.

If the temperatures during rated operation are higher than 70 °C at the feed-in points of cables, lines or pipes, or higher than 80°C at the wire branching points, then cables must be selected whose temperature data correspond to the actual measured temperature values.

Observe the permissible ambient temperature during operation in potentially explosive areas. The permissible ambient temperature range during operation is 0 °C to +45 °C.

The connections of the Panel PC may only be connected or disconnected if the supply voltage has been switched off or if a non-explosive atmosphere is ensured.

Switch off the power supply and ensure that no explosive atmosphere occurs when the CFast card is replaced.

Switch off the power supply and ensure that no explosive atmosphere occurs when changing the battery of the system clock.

The connectors on the backside of the Panel PC must be protected against mechanical damage either with Beckhoff mounting arm adapter C9900-M763 or on site by customer installation.

The protective cap of the USB socket (X102, X103) must be fully tightened to meet the IP65 rating.

Do not use the USB socket on the back side of the Panel PC unless the area is known to be non-hazardous.

The Ethernet sockets (X104, X105) must be closed with the connector of the connection cables (Accessories) or by the protection cover mounted with the nylon cord to meet the IP65 rating.

The cover plate of the CFast card and the battery must be tightened with a torque of 0.5 - 0.6 Nm.

The equipment shall be installed in such a way that the risk of mechanical danger is low.

The equipment shall only be used in an area of not more than pollution degree 2, as defined in IEC 60664-1.

The Panel PC may only be mounted horizontally (see: Mounting).



## 2.2.2 Special conditions (IECEX)

### WARNING

#### Danger of explosion

Gases can be ignited in potentially explosive areas. Read and follow the safety instructions to prevent deflagration or explosions.

Provisions shall be made to prevent the rated voltage from being exceeded by transient disturbances of more than 119 V.

If the temperatures during rated operation are higher than 70 °C at the feed-in points of cables, lines or pipes, or higher than 80°C at the wire branching points, then cables must be selected whose temperature data correspond to the actual measured temperature values.

Observe the permissible ambient temperature during operation in potentially explosive areas. The permissible ambient temperature range during operation is 0 °C to +45 °C.

The connections of the Panel PC may only be connected or disconnected if the supply voltage has been switched off and if a non-explosive atmosphere is ensured.

Switch off the power supply and ensure that no explosive atmosphere occurs when the CFast card is replaced.

Switch off the power supply and ensure that no explosive atmosphere occurs when changing the battery of the system clock.

The connectors on the backside of the Panel PC must be protected against mechanical damage either with Beckhoff mounting arm adapter C9900-M763 or on site by customer installation.

The protective cap of the USB socket (X102, X103) must be fully tightened to meet the IP65 rating.

Do not use the USB socket on the back side of the Panel PC unless the area is known to be non-hazardous.

The Ethernet sockets (X104, X105) must be closed with the connector of the connection cables (Accessories) or by the protection cover mounted with the nylon cord to meet the IP65 rating.

The cover plate of the CFast card and the battery must be tightened with a torque of 0.5 - 0.6 Nm.

The equipment shall be installed in such a way that the risk of mechanical danger is low.

The equipment shall be installed only be used in an area of not more than pollution degree 2, as defined in IEC 60664-1.

The Panel PC may only be mounted horizontally (see: Mounting).

### 2.2.3 Marking

The Panel PC CPX37xx-0010 bears a continuous serial number, markings and a production date on the name plate:

The Panel PC CPX37xx-0010 is certified for potentially explosive areas and bears the following:

<b>CPX3721-0010</b>		Var:000318901
<b>Serial No:</b>	XXXXXXXX	
<b>Date:</b>	11.12.2024	
<b>Mainboard:</b>	CB3263-0008	
<b>CPU:</b>	Atom E3845 1.91GHz	
<b>Memory:</b>	8192MB DDR3L-RAM SO	
<b>Display:</b>	21.5" G215HVN01 V0	
<b>Touchscreen:</b>	21.5" PCT V04.3	
<b>HDD:</b>	SSD 240 GB 3D-Flash	
<b>Power supply:</b>	24V DC, Class 2	
<b>MAC1:</b>	XXXXXXXXXXXX	
<b>MAC2:</b>	XXXXXXXXXXXX	

Beckhoff Automation GmbH & Co. KG  
 Huelshorstweg 20  
 D-33415 Verl, Germany  
 Documentation: www.beckhoff.com

This device complies with Part 15 of the FCC Rules. Operation is subject to the following two conditions: (1) this device may not cause harmful interference, and (2) this device must accept any interference received, including interference that may cause undesired operation.



This Class A digital apparatus complies with Canadian ICES-003.  
 Cet appareil numérique de la classe A est conforme à la norme NMB-003 du Canada.



IECEX DEK 18.0028 X  
 Ex ec IIC T5 Gc

 DEKRA 18ATEX0053 X  
 II 3G Ex ec IIC T5 Gc

See Ctrl. Drw. I/O,CX,CPX for ambient temperature and further instruction  
 FM20US0111X  
 FM20CA0053X  
 CL I, Zn 2 AEx/Ex ec IIC T5 Gc  
 Zn 22 AEx/Ex tc IIIB T100°C Dc  
 CL I, DIV 2, GP A, B, C, D  
 CL II, CL III, DIV 2, GP F, G  
 op temp code T5/T100°C

 **UL** US LISTED  
IND. CONT. EQ. 24775

 **CE**  **UK CA**

  **FM**  
APPROVED

Made in Germany



291.02



**ATEX:**

DEKRA 18ATEX0053 X  
 II 3G Ex ec IIC T5 Gc

**IECEX:**

IECEX DEK 18.0028 X  
 Ex ec IIC T5 Gc

See Ctrl. Drw. I/O,CX,CPX for ambient temperature and further instruction

FM20US0111X

FM20CA0053X

CL I, Zn 2 AEx/Ex ec IIC T5 Gc

Zn 22 AEx/Ex tc IIIB T100°C Dc

CL I, DIV 2, GP A, B, C, D

CL II, CL III, DIV 2, GP F, G

op temp code T5/T100°C

## 2.3 Safety instructions

The following safety instructions must be followed during installation and working with networks and the software.

### Mounting

- Never work on live equipment. Always switch off the power supply for the device before installation, troubleshooting or maintenance. Protect the device against unintentional switching on.
- Observe the relevant accident prevention regulations for your machine (e.g. the BGV A 3, electrical systems and equipment).
- Ensure standard-compliant connection and avoid risks to personnel. Ensure that data and supply cables are laid in a standard-compliant manner and ensure correct pin assignment.
- Observe the relevant EMC guidelines for your application.
- Avoid polarity reversal of the data and supply cables, as this may cause damage to the equipment.
- The devices contain electronic components, which may be destroyed by electrostatic discharge when touched. Observe the safety precautions against electrostatic discharge according to DIN EN 61340-5-1/-3.

### Working with networks

- Limit physical and electronic access to all devices to an authorized group of persons.
- Change the default passwords to reduce the risk of unauthorized access. Regularly change the passwords.
- Install the devices behind a firewall.
- Apply the IT security precautions according to IEC 62443, in order to limit access to and control of devices and networks.

### Working with the software

- Use up-to-date security software. The safe function of the Panel PC can be compromised by malicious software such as viruses or Trojans.
- The sensitivity of an Panel PC against malicious software increases with the number of installed and active software.
- Uninstall or disable unnecessary software.

Further information about the safe handling of networks and software can be found in the Beckhoff Information System:

<http://infosys.beckhoff.com>

Document name
Documentation about IPC Security

## 2.4 Staff qualification

All operations involving Beckhoff software and hardware may only be carried out by qualified personnel with knowledge of control and automation engineering. The qualified personnel must have knowledge of the administration of the Panel PC and the associated network.

All interventions must be carried out with knowledge of control programming, and the qualified personnel must be familiar with the current standards and guidelines for the automation environment.

## 2.5 Operator's responsibility

The operator must ensure that:

- the product is only used as intended.
- the product is in a sound condition and in working order during operation.
- the product is operated, maintained and repaired only by qualified and authorized personnel.
- the personnel is instructed regularly about relevant safety aspects, and is familiar with the operating manual and in particular the safety instructions contained herein.
- the operation manual is in good condition and complete, and always available for reference at the location of the product.

### National regulations

Depending on the type of machine and plant in which the Panel PC is used, national regulations governing the controllers of such machines will apply, and must be observed by the operator. These regulations cover, amongst other things, the intervals between inspections of the controller. The operator must initiate such inspections in good time.

### Procedure in the event of a fault

In the event of faults at the Panel PC, the list in the section [Troubleshooting](#) [▶ 30] can be used to determine the measures to be taken.

### Operator requirements

Anyone who uses the Panel PC must have read these operating instructions and must be familiar with all the functions of the software installed on the Industrial PC to which he has access.

## 3 Transport and storage

### Transport

#### NOTICE

##### Short circuit due to moisture

Moisture can form during transport in cold weather or in the event of large temperature fluctuations.

Avoid moisture formation (condensation) in the Panel PC, and leave it to adjust to room temperature slowly. If condensation has occurred, wait at least 12 hours before switching on the Panel PC.

Despite the robust design of the unit, the components are sensitive to strong vibrations and impacts. During transport the Panel PC must be protected from:

- excessive mechanical stress
- and the original packaging should be used.

Table 1: Dimensions and weight of the individual Panels.

	CPX3715	CPX3719	CPX3721
Dimensions (W x H x D)	375 x 290,9 x 70 mm	445,1 x 364,8 x 70 mm	549,8 x 330,3 x 70 mm
Weight	approx. 6.9 kg	approx. 9 kg	approx. 9.6 kg

### Storage

Store the Panel PC in the original packaging in a dry environment at a temperature between -20°C and 70°C.

### Unpacking

Proceed as follows to unpack the unit:

1. Remove packaging.
2. Do not discard the original packaging. Keep it for future relocation.
3. Check the delivery for completeness by comparing it with your order.
4. Please keep the associated paperwork. It contains important information for handling the unit.
5. Check the contents for visible shipping damage.

If you notice any shipping damage or inconsistencies between the contents and your order, you should notify Beckhoff Service.

## 4 Product overview



No.	Component	Description
1	Multi-touch display	Display with multi-touch technology. A special touch-sensitive interface for the operation and the input of data with the help of gestures.
2	Name plate	Contains information about Serial No., production date and markings for potentially explosive areas.
3	Card slot and battery	CFast card slot and lithium battery of the system clock behind the cover plate
4	Connection block.	With all the interfaces like power supply, Ethernet and USB
5	Fixing holes 100x100 mm	For mounting arm option C9900-M763

The CPX37xx Panel PC series is characterised by a modern operating concept with multi-touch display as well as an advanced, elegant device design. The mounting arm Panel PC is suitable for use in hazardous locations, zone 2/22. The CPX37xx combine reliable Beckhoff Control Panel design with state-of-the-art Industrial PC technology. The right display size is available for every application. With their highly integrated 3½-inch motherboards, the CPX37xx Panel PCs represent a high-performance platform for machine construction and plant engineering applications.

The multi-touch Panel PCs offer the following benefits:

- aluminium housing with glass front.
- all connectors at the backside, all components easily accessible.
- 1 slots for CFast card, accessible from the side.
- Protection class IP 65.
- multi-finger touch screen.
- TFT display in three sizes.

# 4.1 Access to the interfaces

The interface of the Panel PC are located at the back side of the housing and at the side.



Fig. 1: Connection block of the Panel PC CPX37xx-0010 with all interfaces



Fig. 2: CFAST card slot and battery of the system clock behind the cover plate

## 4.2 Name plate

The Panel PC CPX37xx-0010 bears a continuous serial number, markings and a production date on the name plate:

The Panel PC CPX37xx-0010 is certified for potentially explosive areas and bears the following:

**CPX3721-0010**      Var.:000318901

**Serial No:**    xxxxxxxx  
**Date:**            11.12.2024  
**Mainboard:**    CB3263-0008  
**CPU:**             Atom E3845 1.91GHz  
**Memory:**       8192MB DDR3L-RAM 50  
**Display:**        21.5" G215HVN01 V0  
**Touchscreen:** 21.5" PCT V04.3  
**HDD:**             SSD 240 GB 3D-Flash  
**Power supply:** 24V DC, Class 2  
**MAC1:**            xxxxxxxxxxxxxx  
**MAC2:**            xxxxxxxxxxxxxx

Beckhoff Automation GmbH & Co. KG  
 HuelsHORStweg 20  
 D-33415 Verl, Germany  
 Documentation: www.beckhoff.com

This device complies with Part 15 of the FCC Rules. Operation is subject to the following two conditions: (1) this device may not cause harmful interference, and (2) this device must accept any interference received, including interference that may cause undesired operation.

This Class A digital apparatus complies with Canadian ICES-003.  
 Cet appareil numérique de la classe A est conforme à la norme NMB-003 du Canada.

IECEX DEK 18.0028 X  
 Ex ec IIC T5 Gc

 DEKRA 18ATEX0053 X  
 II 3G Ex ec IIC T5 Gc

See Ctrl. Drw. I/O,CX,CPX for ambient temperature and further instruction  
 FM20US0111X  
 FM20CA0053X  
 CL I, Zn 2 AEx/Ex ec IIC T5 Gc  
 Zn 22 AEx/Ex tc IIIB T100°C Dc  
 CL I, DIV 2, GP A, B, C, D  
 CL II, CL III, DIV 2, GP F, G  
 op temp code T5/T100°C

 **UL** **US LISTED**  
IND. CONT. EQ. 247B

 **CE EAC** **UK CA**

 **FM**  
APPROVED

 **CCC**

Made in Germany



291.02



**ATEX:**

DEKRA 18ATEX0053 X  
 II 3G Ex ec IIC T5 Gc

**IECEX:**

IECEX DEK 18.0028 X  
 Ex ec IIC T5 Gc

See Ctrl. Drw. I/O,CX,CPX for ambient temperature and further instruction

FM20US0111X

FM20CA0053X

CL I, Zn 2 AEx/Ex ec IIC T5 Gc

Zn 22 AEx/Ex tc IIIB T100°C Dc

CL I, DIV 2, GP A, B, C, D

CL II, CL III, DIV 2, GP F, G

op temp code T5/T100°C



### 4.3 Description of the interfaces



No.	Interface
1	Power supply (X101)
2	LAN1 (X104)
3	LAN2 (X105) optional
4	USB output (X102-X103)

**Also see about this**

📄 Ground [▶ 18]

#### 4.3.1 Power supply (X101)

**i** **Conductive cross-section**

The connector is specified for 7.5 A and can lift conductive cross-sections of 1.5 mm<sup>2</sup>.

The power supply for the Panel-PC is established via the socket X101. The power supply connector is included in delivery.

The power supply and the external circuit of the Panel PC are connected via the 4-pole plug connector (Conec SAL-12S-RKC4-S/075/BF, 43-00333):

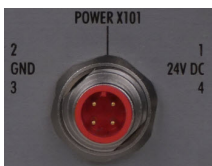
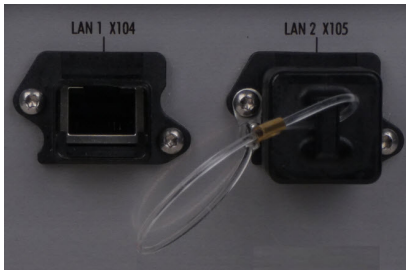

Fig. 3: Power supply X101 of the CPX37xx-0010.

Table 2: Power supply (X101), pin assignment.

Pin	Function	Pin	Function
1	24V DC	3	GND
2	GND	4	24V DC

### 4.3.2 LAN1, LAN2 (X104, X105)



#### X104, X105

Connection via standard-RJ45-cabel

The RJ-45 connectors (X104, X105) allow the PC to be connected to a 100/1000 BASE-T Local Area Network (LAN).

The standard configuration is only with one LAN Port X104.

Optional a second LAN port X105 is available.

### 4.3.3 USB output (X102, X103)



#### X102, X103

Socket USB-A 2-port M23

The USB interface (X102, X103, connector type A) are connecting peripheral devices with USB connection. USB 2.0 standard is supported.

Pin	Signal	Pin	Signal
1	5V	3	D+
2	D-	4	GND

### 4.3.4 Ground

#### ● Malfunction possible with missing ground connection

**i** A proper ground connection of the device is absolutely necessary for the correct function of the touchscreen.

The Panel PC is grounded via the screw connection (**Ground**).

A wire cross section of min. 4 mm<sup>2</sup> is required.

### 4.3.5 Access to the battery and the CFast card slot

The battery and the CFast card slot are located behind a cover plate at the side of the Panel PC.



After removing the screws with a star screwdriver Torx size 10 the cover plate can be taken off.



Removing the cover plate allows access to the CFast card slot and the battery.

**⚠ WARNING**

**Danger of Explosion!**

Replace battery only with the identical type or an alternative type recommended by the manufacturer. Notice correct polarity!

## 5 Mounting and wiring

### 5.1 Mounting

The Panel PC CPX37xx is designed for industrial application in machine and plant engineering. The Panel PC is intended for mounting arm installation either via 100 x 100 mm mounting interface or optional available mounting arm adapter for mounting arm systems with 48 mm tube (C9900-M763). The ambient conditions specified for operation must be observed (see chapter: Technical Data).

#### Permitted mounting position

The Panel PC may only be mounted horizontally.



#### 5.1.1 Preparation of the Panel PC

##### ● Circulation of air

**i** In order to ensure adequate ventilation of the Panel PC, 20 cm free space is required around the PC for air circulation.

Please note the following points during installation of the Panel PC:

- Position the Panel PC in such a way that reflections on the screen are avoided as far as possible.
- Use the position of the screen as a guide for the correct installation height; it should be optimally visible for the user at all times.
- The Panel PC should not be exposed to direct sunlight.
- When the unit is in its mounting position, the ventilation openings must not be obstructed.

#### NOTICE

##### Avoid extreme environmental conditions

Extreme environmental conditions should be avoided as far as possible. Protect the Panel PC from dust, moisture and heat.

**Earthing measures**

Earthing connections dissipate interference from external power supply cables, signal cables or cables to peripheral equipment. Establish a low-impedance connection from the earthing point on the Panel PC housing to the central earthing point on the control cabinet wall, in which the Panel PC is being installed.

**Malfunction possible with missing ground connection**

A proper ground connection of the device is absolutely necessary for the correct function of the touchscreen.

---

### 5.1.2 Mounting the mounting arm tube

After feeding the connection cables of the Panel PC through the mounting arm tube (1), the mounting arm tube will be positioned into the mounting arm adapter. Also the mounting arm tube is locked by tightening the Allen screw in the region of the socket (3) with a 3 mm Allen key.

Proceed as follows to install the mounting arm tube:

- First unscrew the Allen screw in the region of the socket (3) several cycles with a 3 mm Allen key.
- Push the mounting arm tube (1) into the mounting arm adapter all the way to stop.
- Now the slotted nut of the mounting arm adapter is tightened carefully clockwise, using a hook wrench SW 58-62 (2).
- Also the mounting arm tube is locked by tightening the Allen screw (3) with the 3 mm Allen key with a torsion moment of 4.0 till 4.5 mm.

Order Number	Description
C9900-Z263	Hook wrench size 58-62 for tying up the slotted nut of the mounting arm adapter C9900-M75x

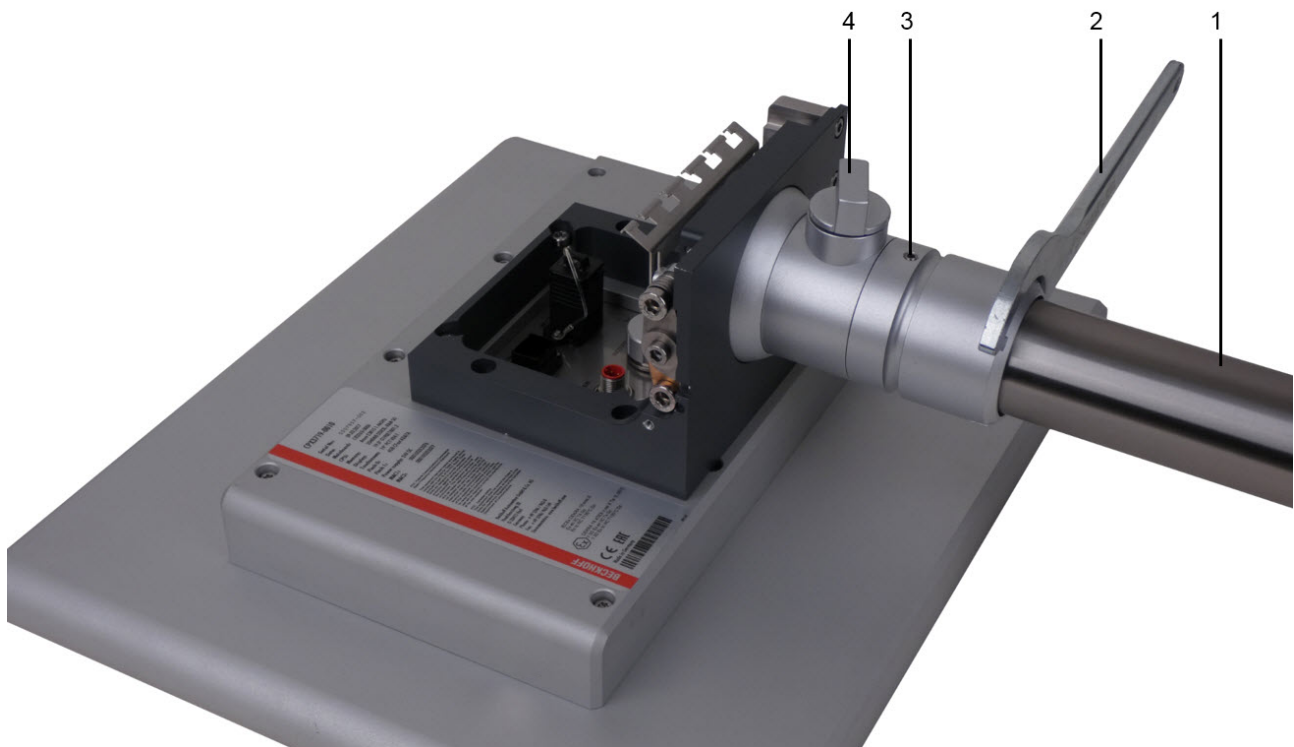

The mounting arm adapter enables to tilt the Panel PC at +/- 20°.

After loosening the fixing knob (4) you can rotate the Panel PC about +/- 150°.

#### NOTICE

##### **Anti-twist protection**

The mounting arm adapter is fitted with an anti-twist safeguard to avoid over winding the Panel PC and damaging the connection cables.

### 5.1.3 Mounting arm adapter (Optional C9900-M763)

The Panel PC is designed for mounting arm installation from top or bottom. The mounting arm adapter is designed for Rittal- and Rolec mounting arm system with 48 mm tubes.

**NOTICE****Tolerance of the mounting arm tube diameter**

The mounting arm tube must have a diameter of 48 mm with a maximum tolerance of  $-0.1 \text{ mm} / +0.8 \text{ mm}$ .



## 5.2 Wiring

### 5.2.1 Preparation and protective earthing

#### NOTICE

##### The mains plug must be disconnected

Please read the documentation for the external devices prior to connecting them! During thunderstorms, plug connector must neither be inserted nor removed! When disconnecting a plug connector, always handle it at the plug. Do not pull the cable!

#### Connecting cables

The connections are located at the back of the Panel PC and are documented in the chapter Interfaces.

When connecting cables to the Panel PC, please adhere to the following order:

- Disconnect the Panel PC from the power supply.
- Connect all cables at the Panel PC and at the devices to be connected.
- Ensure that all screw connections between connectors and sockets are tight!
- Reconnect all devices to the power supply.

#### Protective Earthing

##### ● Malfunction possible with missing ground connection



A proper ground connection of the device is absolutely necessary for the correct function of the touchscreen.

The low resistance protective earthing connection of the Control Panel is established via the screw connection, which is located in the connection area.

A wire cross-section of min. 4 mm<sup>2</sup> is required.

## 5.2.2 Connecting

### **NOTICE**

#### **Use the correct fuse**

The power supply must be protected with maximum 4 A.

#### **Cable Cross Sections**

For the connection of the power supply, wiring with a cable-cross-section of 0.5 ... 1.5 mm<sup>2</sup> must be used.

With bigger distances between voltage source and PC, you take the voltage drop as a function of the cable-cross-section as well as voltage fluctuations of your distribution voltage into account, so that is secured that the voltage doesn't fall under 22 V at the power supply.

#### **Check voltage rating and connect**

Fitted with the 24 VDC power supply unit:

1. Check that the external power supply is providing the correct voltage.
2. Insert the power supply cable that you have assembled into the Industrial PC's power supply socket. Then connect it to your external 24 V power supply.

### 5.2.3 Fitting the power supply

#### M12 female 4 pos. field attachable, screw termination

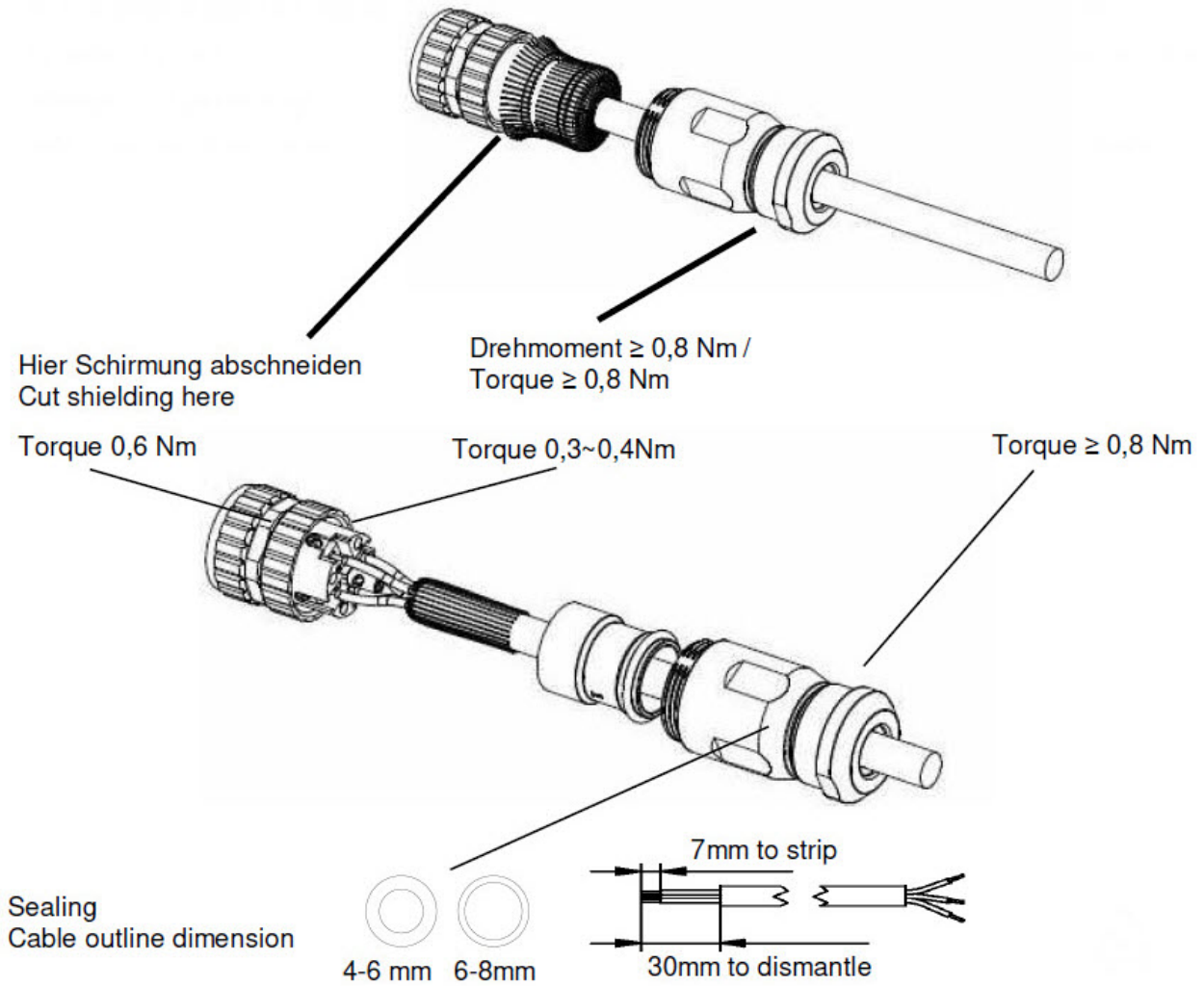

## 6 Operation

### 6.1 Switching the Panel PC on and off

#### Switching on

The Panel PC does not have its own mains power switch. As soon as the power supply is switched on the Panel PC is activated.

#### Shutting down and switching off

Control software such as is typically used on Industrial PCs permits various users to be given different rights. A user who may not close software may also not switch the Industrial PC off, since data can be lost from the storage medium by switching off while software is running.

#### NOTICE

##### First shut down, then switch off!

If the Industrial PC is switched off as the software is writing a file to the storage medium, the file will be destroyed. Control software typically writes something to the storage medium every few seconds, so that the probability of causing damage by switching off while the software is running is very high.

#### NOTICE

##### Switch off power supply

When you have shut down the Industrial PC, you have to switch off power supply for at least 10 seconds before rebooting the system.  
After resetting power supply the Industrial PC will start booting automatically.

### 6.2 Touch screen

The operation of the Panel PC occurs via the Touch Screen.

#### NOTICE

##### Risk of damaging the Touch Screen

The touch screen may only be actuated by finger tips or with the touch screen pen. The operator may wear gloves but there must be no hard particles such as metal shavings, glass splinters embedded in the glove.

#### NOTICE

##### Properly installation of the system and the multi-touch device

Capacitive Touch Screens use the functional principle of capacitive alternation of the electrical field. Strong electrical fields can influence the functionality of the multi-touch devices.  
To ensure the correct function of the Touch Screen take care of a standardized installation of all parts of the system and an EMC-environment conforming to standards.

## 6.3 Servicing and maintenance

### Cleaning

#### WARNING

##### **Disconnect power supply**

Switch off the device and all connected devices, and disconnect the device from the power supply.

The device can be cleaned with a soft, damp cleaning cloth. Do not use any aggressive cleaning materials, thinners, scouring material or hard objects that could cause scratches.

### Maintenance

The Panel PC is maintenance-free. Do not open the Panel PC. For hardware problems, please contact the Beckhoff Service

## 6.4 Emergency procedures

In case of fire, the Panel PC should be extinguished with powder or nitrogen.

## 6.5 Shutting down

### Disposal

#### **Observe national electronics scrap regulations**

Observe the national electronics scrap regulations when disposing of the device.

In order to dispose of the device, it must be removed and fully dismantled:

- Housing components (polycarbonate, polyamide (PA6.6)) are suitable for plastic recycling.
- Metal parts can be sent for metal recycling.
- Electronic parts such as disk drives and circuit boards must be disposed of in accordance with national electronics scrap regulations.

## 7 Troubleshooting

● **Pixel errors**

**i** Pixel errors in the TFT display are production-caused and represent no complaint- reason!

● **Anomalies of the Touchscreen**

**i** Anomalies of the touchscreen sensor are production-caused and represent no complaint-reason!

Fault	Cause	Measures
The Panel PC shows no function	No power supply to the Panel PC/ Industrial PC  Cable not connected	Check power supply cable  1. Correctly connect cable 2. Call Beckhoff Service
Computer boots, software starts, but control does not operate correctly	Cause of the fault is either in the software or in parts of the plant outside the Industrial PC	Call the manufacturer of the machine or the software
Malfunction of the touchscreen	Bad or missing ground connection of the device	Establish ground connection
	Bad or missing ground connection of the user	User must stand on the floor with ordinary shoes
USB error while TwinCAT access via USB	Cycle time in TwinCAT is set on 10 ms (standard)	Increase the cycle time up to 50 ms till 80 ms
The Panel PC functions only partially or only part of the time, e.g. no or dark picture	Faulty backlight in the display  Defective components in the Panel PC	Call Beckhoff Service  Call Beckhoff Service

# 8 Assembly dimensions

CPX3715-0010

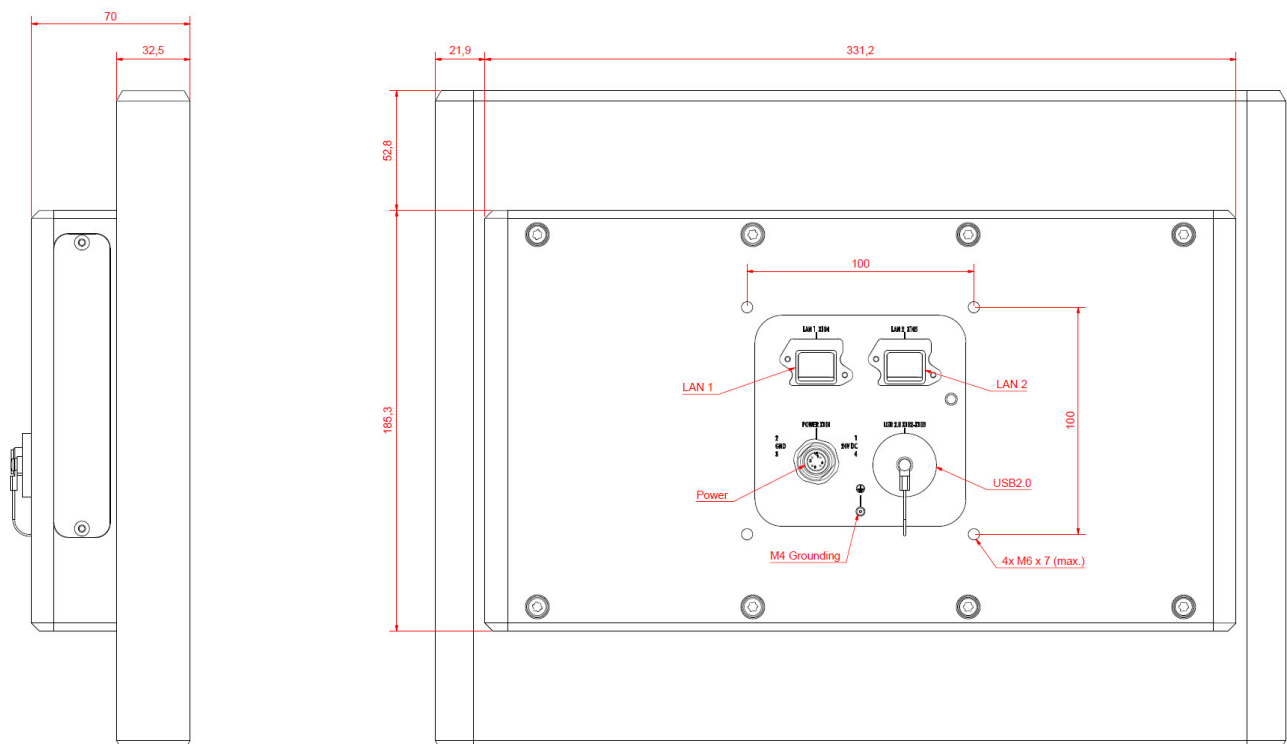
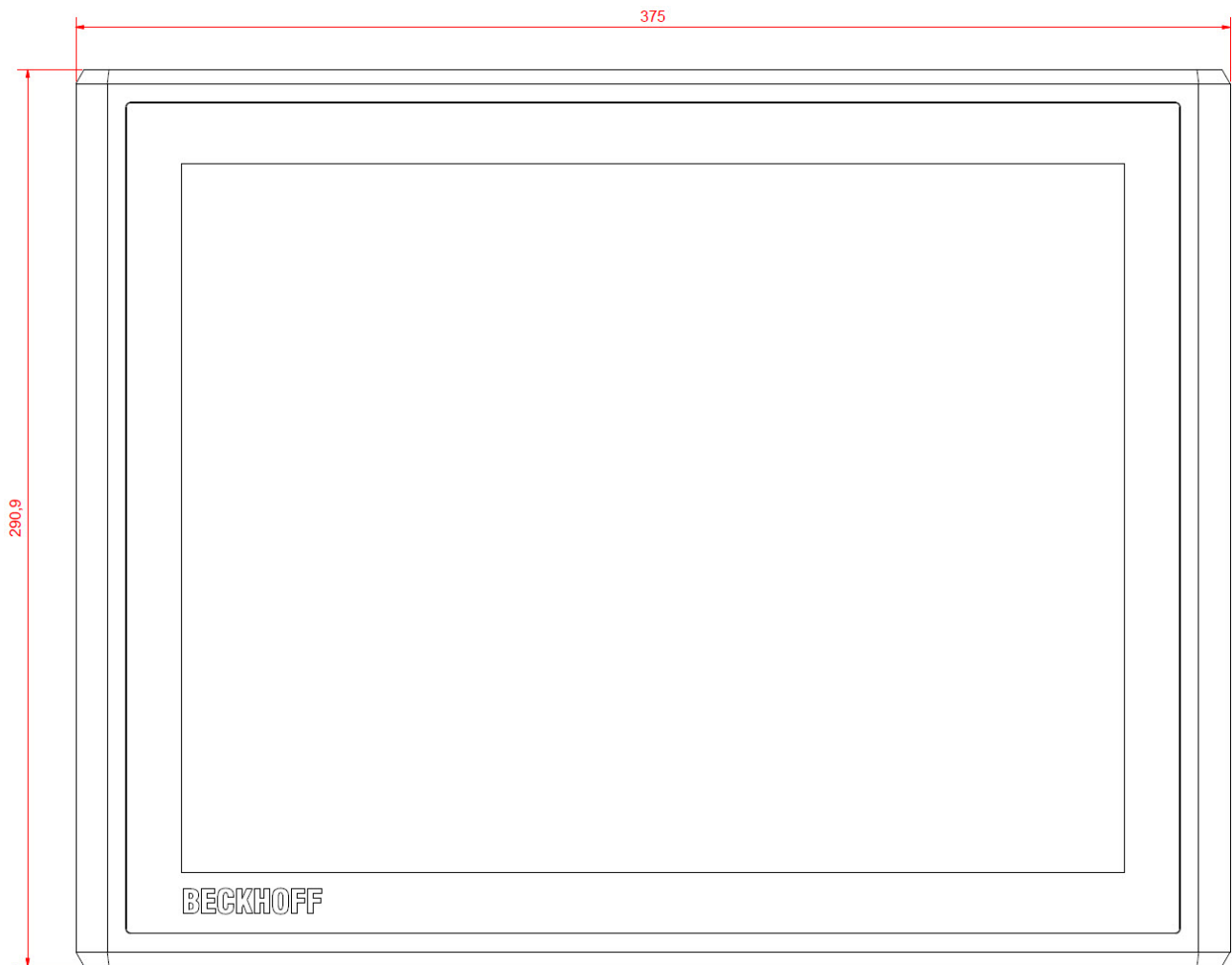

**CPX3719-0010**

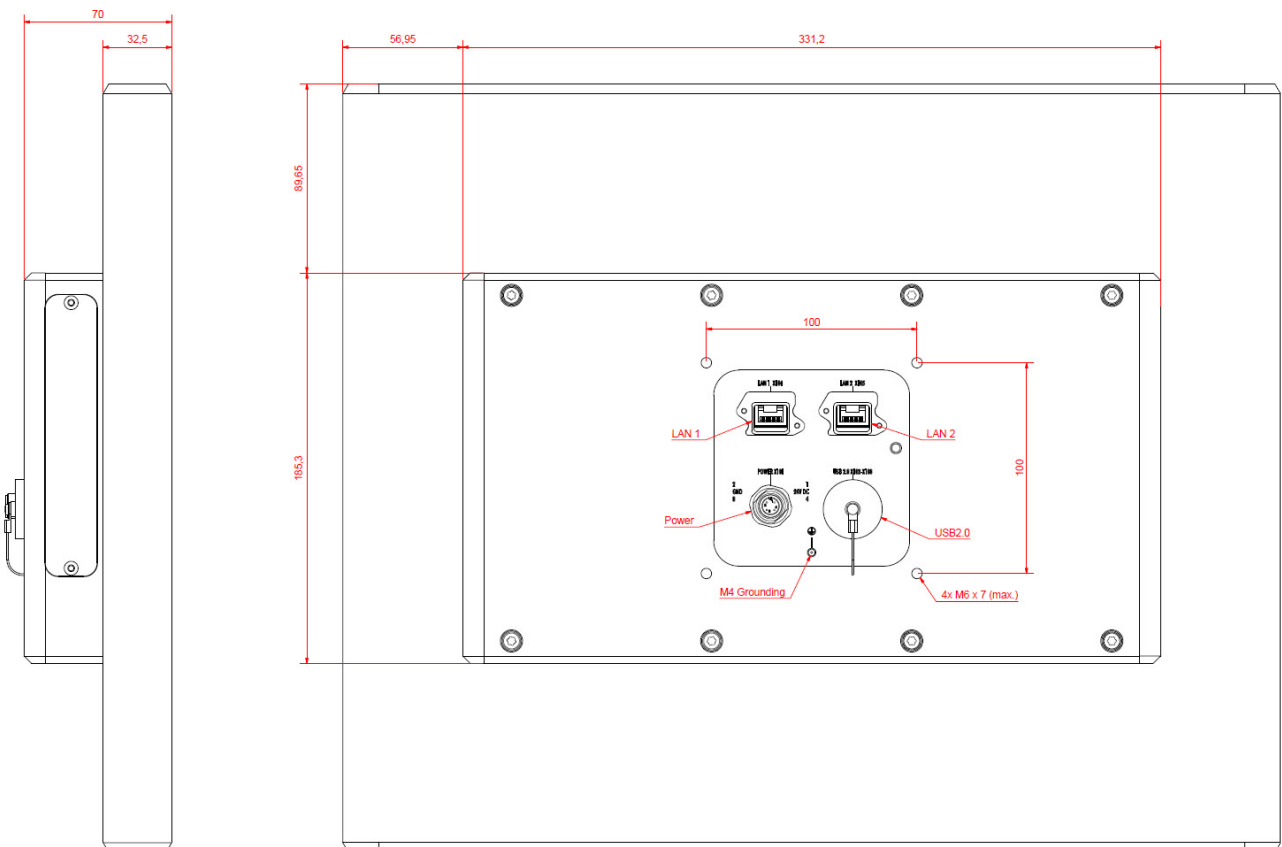
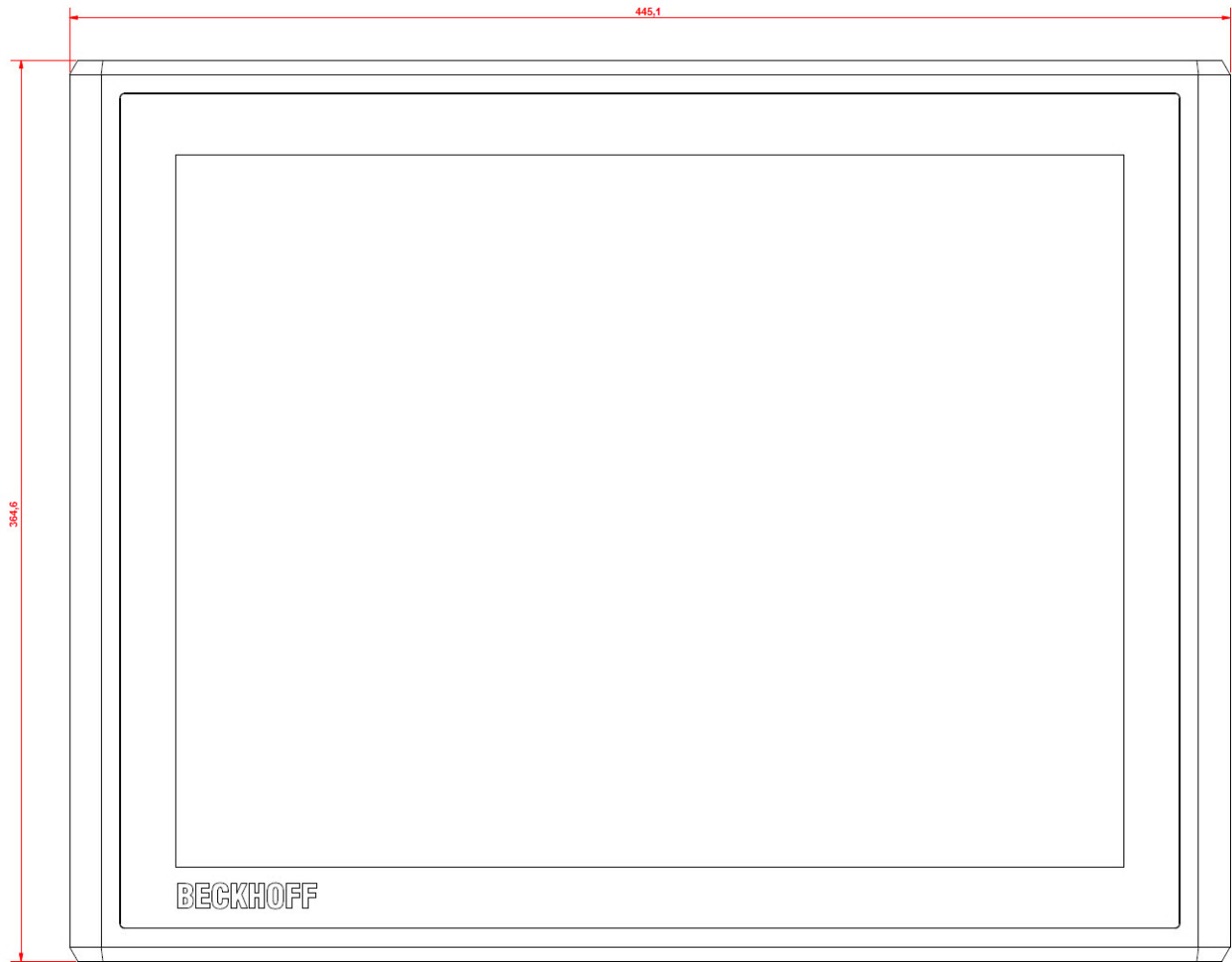



CPX3721-0010

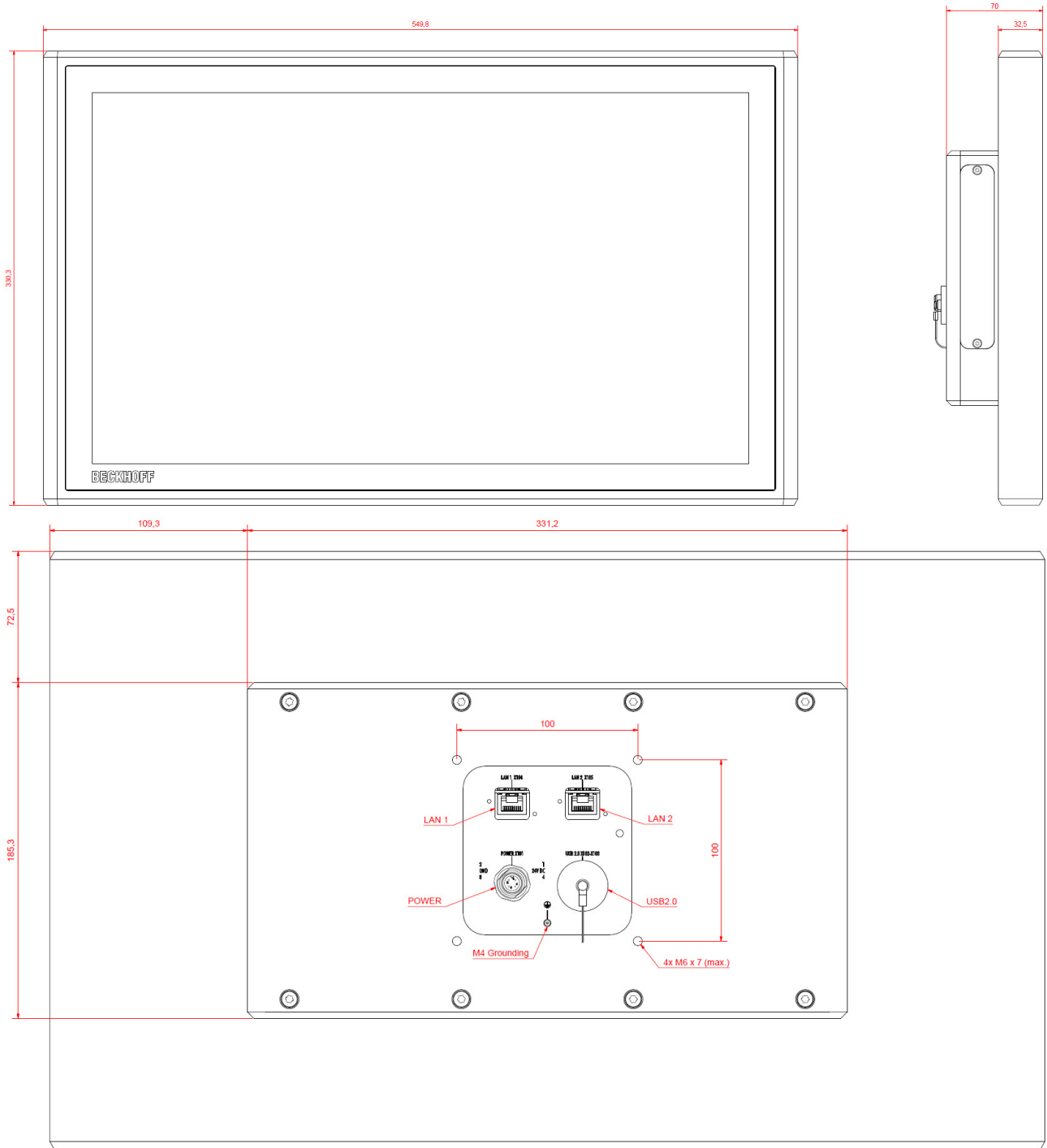

## 9 Technical Data

Product name	CPX3715-0010	CPX3719-0010	CPX3721-0010
Dimensions (W x H x D)	375 x 290.9 x 70 mm	445.1 x 364.8 x 70 mm	549.8 x 330.3 x 70 mm
Weight	approx. 6.9 kg	approx. 9 kg	approx. 9.6 kg
Supply voltage	24 V DC (22 – 30 V DC)		
Power consumption	max. 25 W	max. 35 W	max. 40 W
UL-compliance (in progress)	<ul style="list-style-type: none"> <li>Using a power supply class 2 or</li> <li>Fuse protection with 4 A, according to UL 60950.2 chapter 2.5, table 2C</li> </ul>		
Interfaces	1 Ethernet adapter 10/100/1000BASE-T with RJ-45 connection Second Ethernet adapter optional 2 USB 2.0 interfaces		
Protection class	IP65		
Shock resistance (Sinusoidal vibration)	EN 60068-2-6:	10 bis 58 Hz:	0,035 mm
		58 bis 500 Hz	0,5 G (~ 5 m/ s <sup>2</sup> )
Shock resistance (Shock)	EN 60068-2-27:	5 G (~ 50 m/ s <sup>2</sup> ), duration: 30 ms	
EMC compatibility	Resistance to interference conforms to EN 61000-6-2		
EMC compatibility	Emission of interference conforms to EN 61000-6-4		
Permissible ambient temperature	Operation: 0°C to +45° Transport/ storage: -20°C to +70°C		
Pollution degree	2		
Permissible relative humidity	to 95%, no condensation		
Transport and storage	The same values for atmospheric humidity and shock resistance are to be observed during transport and storage as in operation. Suitable packaging of the Panel PC can improve the resistance to impact during transport.		
Certifications	CE, ATEX, IECEx, cFMus		

# 10 Appendix

## 10.1 Standards reference for explosive atmospheres

The following standards have been used:

### ATEX

Standard	Description
EN 60079-0:2012+A11:2013	Explosive atmospheres - Part 0: Equipment - General requirements
EN 60079-7:2015+A1:2018	Explosive atmospheres - Part 7: Equipment protection by increased safety "e"

### IECEx

Standard	Description
IEC 60079-0:2011	Explosive atmospheres - Part 0: Equipment - General requirements
IEC 60079-7:2017	Explosive atmospheres – Part 7: Equipment protection by increased safety "e"

### cFMus

Standard	Description
FM Class 3600:2018	Electrical Equipment for Use in Hazardous (Classified) Locations – General Requirements
FM Class 3611:2018	Nonincendive electrical equipment for use in Class I and II, Division 2 and Class III, Divisions 1 and 2 hazardous (classified) locations
FM Class 3810:2018	Electrical Equipment for Measurement, Control and Laboratory Use
ANSI/UL 121201:2019	Nonincendive electrical equipment for use in Class I and II, Division 2 and Class III, Divisions 1 and 2 hazardous (classified) locations
ANSI/ISA 61010-1:2012	Safety requirements for electrical equipment for measurement, control, and laboratory use – Part 1: General requirements
ANSI/UL 60079-0:2020	Explosive atmospheres – Part 0: Equipment – General requirements
ANSI/UL 60079-7:2017	Explosive atmospheres – Part 7: Equipment protection by increased safety "e"
ANSI/UL 60079-31:2015	Explosive atmospheres – Part 31: Equipment dust ignition protection by enclosure "t"
CAN/CSA C22.2 No. 213-17:2017	Nonincendive electrical equipment for use in Class I and II, Division 2 and Class III, Divisions 1 and 2 hazardous (classified) locations
CSA C22.2 No. 60079-0:2019	Explosive atmospheres – Part 0: Equipment – General requirements
CAN/CSA C22.2 No. 60079-7:2016	Explosive atmospheres – Part 7: Equipment protection by increased safety "e"
CAN/CSA C22.2 No. 60079-31:2015	Explosive atmospheres – Part 31: Equipment dust ignition protection by enclosure "t"
CAN/CSA C22.2 No. 61010-1:2012	Safety requirements for electrical equipment for measurement, control, and laboratory use – Part 1: General requirements

## 10.2 Approvals for USA and Canada

### FCC: Federal Communications Commission Radio Frequency Interference Statement

This equipment has been tested and found to comply with the limits for a Class A digital device, pursuant to Part 15 of the FCC Rules. These limits are designed to provide reasonable protection against harmful interference when the equipment is operated in a commercial environment. This equipment generates, uses, and can radiate radio frequency energy and, if not installed and used in accordance with the instruction manual, may cause harmful interference to radio communications. Operation of this equipment in a residential area is likely to cause harmful interference in which case the user will be required to correct the interference at his own expense.



#### Technical modifications

Technological changes to the device may cause the loss of the FCC approval.

---

### FCC: Canadian Notice

This equipment does not exceed the Class A limits for radiated emissions as described in the Radio Interference Regulations of the Canadian Department of Communications.

### 10.3 Connection Kits/ Connecting Cables/ Accessories

One 4-pole power supply connector is provided with the Panel PC. Optionally prefabricated connection cables for the network connection are available.

<b>Connecting cables</b>	<b>Network cable with IP65 connector</b>
C9900-K281	network cable for CP32xx, CP37xx, CPX37xx and CP72xx, length 3 m, assembled, Harting push-pull Ethernet connector IP 65, second end RJ45, IP 20
C9900-K282	network cable for CP32xx, CP37xx, CPX37xx and CP72xx, length 5 m, assembled, Harting push-pull Ethernet connector IP 65, second end RJ45, IP 20
C9900-K283	network cable for CP32xx, CP37xx, CPX37xx and CP72xx, length 10 m, assembled, Harting push-pull Ethernet connector IP 65, second end RJ45, IP 20
C9900-K284	network cable for CP32xx, CP37xx, CPX37xx and CP72xx, length 15 m, assembled, Harting push-pull Ethernet connector IP 65, second end RJ45, IP 20
C9900-K285	network cable for CP32xx, CP37xx, CPX37xx and CP72xx, length 20 m, assembled, Harting push-pull Ethernet connector IP 65, second end RJ45, IP 20
C9900-K286	network cable for CP32xx, CP37xx, CPX37xx and CP72xx, length 30 m, assembled, Harting push-pull Ethernet connector IP 65, second end RJ45, IP 20
C9900-K287	network cable for CP32xx, CP37xx, CPX37xx and CP72xx, length 40 m, assembled, Harting push-pull Ethernet connector IP 65, second end RJ45, IP 20
C9900-K288	network cable for CP32xx, CP37xx, CPX37xx and CP72xx, length 50 m, assembled, Harting push-pull Ethernet connector IP 65, second end RJ45, IP 20

<b>Accessories</b>	<b>Mounting arm adapter</b>
C9900-M763	Rotatable and tiltable mounting arm adapter for customised Multi-touch Panel PC CPX37xx-0010, for Rittal and Rolec mounting arm systems with 48 mm tube, wiring through the mounting arm. For mounting four M6 tapped holes at a distance of 100 x 100 mm and 70 x 130 mm. Turnable by customer, not mounted at the factory.

## 10.4 Support and Service

Beckhoff and their partners around the world offer comprehensive support and service, making available fast and competent assistance with all questions related to Beckhoff products and system solutions.

### Beckhoff's branch offices and representatives

Please contact your Beckhoff branch office or representative for [local support and service](#) on Beckhoff products!

The addresses of Beckhoff's branch offices and representatives round the world can be found on her internet pages:

<http://www.beckhoff.com>

You will also find further [documentation](#) for Beckhoff components there.

### Beckhoff Headquarters

Beckhoff Automation GmbH & Co. KG

Huelshorstweg 20  
33415 Verl  
Germany

Phone: +49(0)5246/963-0  
Fax: +49(0)5246/963-198  
e-mail: [info@beckhoff.com](mailto:info@beckhoff.com)

### Beckhoff Support

Support offers you comprehensive technical assistance, helping you not only with the application of individual Beckhoff products, but also with other, wide-ranging services:

- support
- design, programming and commissioning of complex automation systems
- and extensive training program for Beckhoff system components

Hotline: +49(0)5246/963-157  
Fax: +49(0)5246/963-9157  
e-mail: [support@beckhoff.com](mailto:support@beckhoff.com)

### Beckhoff Service

The Beckhoff Service Center supports you in all matters of after-sales service:

- on-site service
- repair service
- spare parts service
- hotline service

Hotline: +49(0)5246/963-460  
Fax: +49(0)5246/963-479  
e-mail: [service@beckhoff.com](mailto:service@beckhoff.com)



Beckhoff Automation GmbH & Co. KG  
Hülshorstweg 20  
33415 Verl  
Germany  
Phone: +49 5246 9630  
[info@beckhoff.com](mailto:info@beckhoff.com)  
[www.beckhoff.com](http://www.beckhoff.com)