



Installation and Operating instructions for
Build-in Industrial PC
C33xx up to -0050

Version: 1.5
Date: 2018-01-31

BECKHOFF

Table of contents

1. Foreword	3
Notes on the Documentation	3
Liability Conditions	3
Trademarks	3
Patent Pending	3
Copyright	3
State at Delivery	3
Delivery conditions	3
Description of safety symbols	4
Basic safety measures	5
Operator's obligation to exercise diligence	6
Operator requirements	6
2. Product Description	7
Appropriate Use	7
Structure	7
Interfaces up to C33xx-0040	10
PS/2-connectors	10
Parallel interface	10
Serial interfaces	10
VGA connection	10
USB interfaces	10
Network connection	10
Sound-On-Board	10
Additional plug-in cards (optional)	10
Interfaces C33xx-0050	11
PS/2 connections	11
Serial interfaces	11
USB interfaces	11
Network connection	11
Sound-On-Board	11
DVI-I (Digital Visual Interface)	11
DVI-D (Digital Visual Interface)	11
DisplayPort	11
Additional plug-in cards (optional)	11
3. Installation Instructions	12
Transport and Unpacking	12
Transport	12
Unpacking	12
Installation of the PC in the control cabinet	13
Earthing measures	13
Power Supply Connection	14
Current carrying capacity of the 100-240 V power supply unit	14
Current carrying capacity of the 24 V power supply unit	14
Differently coded Connectors	15
Fitting the Power Supply Cable	15
Connecting devices	17
Connecting cables	17
Check voltage rating and connect	17
4. Operating Instructions	18
Switching the Industrial PC on and off	18
First switching on and driver installation	18
Operating the Industrial-PC	19
Description of the keys	19
Function keys	20
Special keys	20
Maintenance	21
Cleaning the Industrial PC	21
Replacing the battery on the motherboard	21
Servicing	21
Shutting down	21

Disposal	21
5. Troubleshooting	22
Fault correction	22
Beckhoff Support and Service	23
Beckhoff branches and partner companies	23
Beckhoff company headquarters	23
Beckhoff Support	23
Beckhoff Service	23
6. Assembly dimensions	24
7. Appendix	28
Technical data	28
Approvals	28
FCC: Federal Communications Commission Radio Frequency Interference Statement	28
FCC: Canadian Notice	28

Foreword

Notes on the Documentation

This description is only intended for the use of trained specialists in control and automation engineering who are familiar with the applicable national standards. It is essential that the following notes and explanations are followed when installing and commissioning these components.

The responsible staff must ensure that the application or use of the products described satisfy all the requirements for safety, including all the relevant laws, regulations, guidelines and standards.

Liability Conditions

The documentation has been prepared with care. The products described are, however, constantly under development. For that reason the documentation is not in every case checked for consistency with performance data, standards or other characteristics. In the event that it contains technical or editorial errors, we retain the right to make alterations at any time and without warning. No claims for the modification of products that have already been supplied may be made on the basis of the data, diagrams and descriptions in this documentation.

All pictures shown in the documentation are exemplary. Illustrated configurations can differ from standard.

Trademarks

Beckhoff[®], TwinCAT[®], EtherCAT[®], Safety over EtherCAT[®], TwinSAFE[®] and XFC[®] are registered trademarks of and licensed by Beckhoff Automation GmbH.

Other designations used in this publication may be trademarks whose use by third parties for their own purposes could violate the rights of the owners.

Patent Pending

The EtherCAT Technology is covered, including but not limited to the following patent applications and patents:

EP1590927, EP1789857, DE102004044764, DE102007017835

with corresponding applications or registrations in various other countries.

The TwinCAT Technology is covered, including but not limited to the following patent applications and patents:

EP0851348, US6167425 with corresponding applications or registrations in various other countries.

Copyright

© Beckhoff Automation GmbH & Co.KG.

The reproduction, distribution and utilization of this document as well as the communication of its contents to others without express authorization are prohibited. Offenders will be held liable for the payment of damages. All rights reserved in the event of the grant of a patent, utility model or design.

State at Delivery

All the components are supplied in particular hardware and software configurations appropriate for the application. Modifications to hardware or software configurations other than those described in the documentation are not permitted, and nullify the liability of Beckhoff Automation GmbH & Co.KG.

Delivery conditions

In addition, the general delivery conditions of the company Beckhoff Automation GmbH & Co.KG apply.

Description of safety symbols

The following safety symbols are used in this operating manual. They are intended to alert the reader to the associated safety instructions.



Danger

This symbol is intended to highlight risks for the life or health of personnel.



Warning

This symbol is intended to highlight risks for equipment, materials or the environment.



Note

This symbol indicates information that contributes to better understanding.

Basic safety measures

Only switch the PC off after closing the software

Before the Industrial PC is switched off, software that is running must be properly closed.

Otherwise it is possible that data on the hard disk is lost. Please read the section on [Switching the Industrial PC on and off](#).



Warning

Switch off all parts of the equipment, then uncouple the fieldbus!

Before opening the housing of the PC, and whenever the PC is being used for purposes other than plant control, such as during functional tests following repair, all parts of the equipment must first be switched off, after which the Industrial PC can be uncoupled from the plant.

Pulling out the fieldbus connection plug uncouples the PC (optional).

Items of equipment that have been switched off must be secured against being switched on again.

The Industrial PC's power supply unit must be supplied with 100-240 V_{AC} or 24 V_{DC} (optional).



Danger

Do not exchange any parts when under power!

When components are being fitted or removed, the supply voltage must be switched off.

Fitting work on the Industrial PC can result in damage:

- If metal objects such as screws or tools fall onto operating circuit boards.
- If connecting cables internal to the PC are removed or inserted during operation.
- If plug-in cards are removed or inserted when the PC is switched on.

Operator's obligation to exercise diligence

The operator must ensure that

- the Industrial PC is only used for its intended use (see also chapter [Product Description](#)).
- the Industrial PC is in a sound condition and in working order during operation.
- the operation manual is in good condition and complete, and always available for reference at the location of the Industrial PC.
- the Industrial PC is operated, maintained and repaired only by sufficiently qualified and authorised personnel.
- the personnel is instructed regularly about relevant occupational safety and environmental protection aspects, and is familiar with the operating manual and in particular the safety notes contained herein.
- none of the safety and warning notes attached to the Industrial PC are removed, and that all notes remain legible.

National regulations depending on the machine type

Depending on the type of machine and plant in which the Industrial PC is being used, there will be national regulations for the control of such machines and plant that the operator must observe. These regulations cover, amongst other things, the intervals between inspections of the controller.

The operator must initiate such inspections in good time.



Warning

Only trained persons may open the Industrial PC housing!

The operator is responsible for ensuring that only trained electrical staff opens the housing of the Industrial PC.

Procedure in the event of a fault

In the event of a fault in the Industrial PC, appropriate measures can be determined with the aid of the list in the [Fault correction](#) section.

Operator requirements

Read the operating instructions

Every user of the Industrial PC must have read these operating instructions.

Software knowledge

Every user must be familiar with any of the functions of the software installed on the PC that he can reach.

Product Description

Appropriate Use

The C33xx Industrial PC is designed for mounting in control cabinets for machine and plant engineering applications. In addition to the PC with standard ATX-motherboard, a hard disk, floppy disk drive, machine-fair keyboard and a TFT display are integrated in a 19 inch rack.

Structure

Lockable front flap

There is a lockable front flap above the display, behind which a floppy disk drive, a CD-ROM/ DVD drive (**optional**), status-LEDs, a reset button and a further lock for opening the front cover are located.

Lock for opening the front flap (see arrow).



When the front flap has been unlocked, it can be folded upwards.

Front view of the Industrial PC C33xx with front flap opened



Opening the housing

The housing is opened from the front. Under the front flap there is a lock to open the front door (**see arrow**). The key differs from that the front flap, so that between users and service personnel can be differentiated administratively.

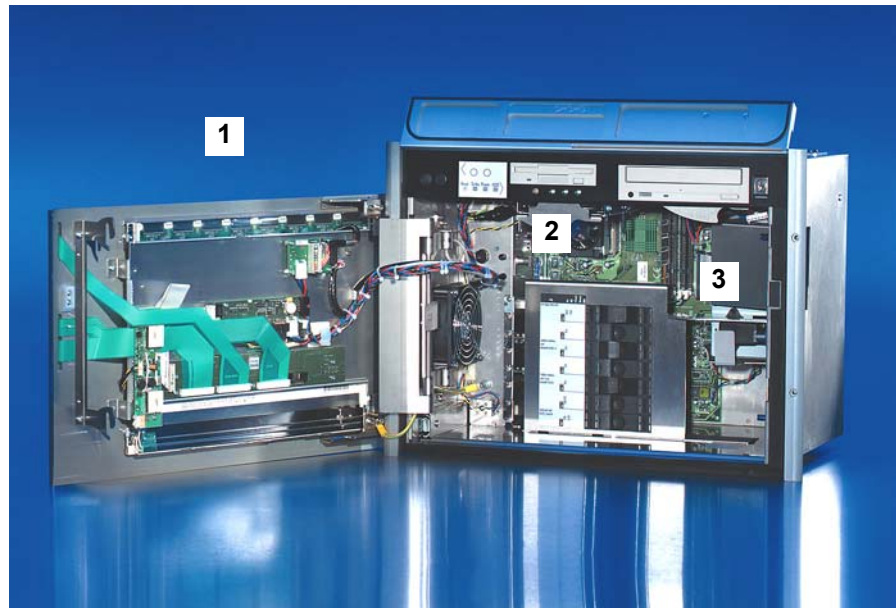

The second lock is only to be opened by service technicians for the purposes of fitting, extending or repairing the controller! The key must only be available to the service personnel.

Internal view of the PC

Behind the front door (1) is a 7 slot computer core with standard ATX motherboard (2) and power supply unit (3).

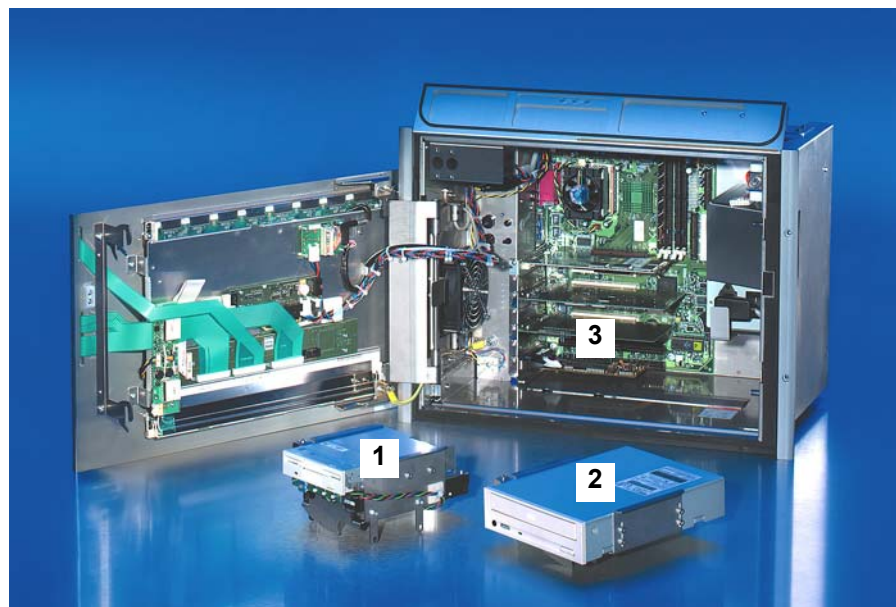
Removing the drives

The drives (1, 2) can be removed without using any tool.
After removing the card holder the plug-in cards (3) can be removed.

Connections of the Industrial PC

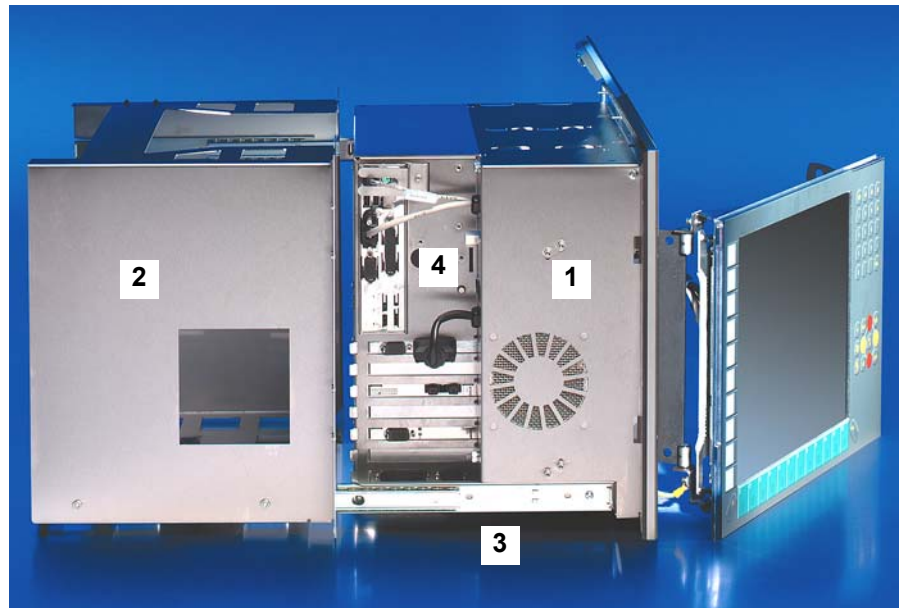

The illustration shows the assembly of the PC (1) with excerpt frameworks (2) and telescope rails (3). The interface connections are at the side of the housing (4).

Connections behind the front flap

The connections for the mouse (1) and the keyboard (2) are located behind the front flap.

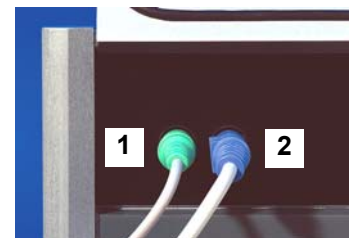

Interfaces up to C33xx-0040

*ATX motherboard
interfaces*



PS/2

PS/2-connectors

The lower PS/2 connector (2) allows a keyboard to be used, while a PS/2 mouse can be connected to the upper PS/2 connector (1). If the PC is fitted with an optional Touch Pad this PS/2 connection is occupied.

*Printer
LPT1*

Parallel interface

The parallel interface (3) corresponds to the Centronics standard, and is addressed by the software as LPT1.

*RS 232
COM1 – COM2*

Serial interfaces

The basic version of the Industrial PC has two serial interfaces, COM1 (4) and COM2, using the type RS 232, which are each brought to a 9 pin SUB-D plug connector. The interface COM2 is located in the first slot right below the ATX-slot.

One of the two serial interfaces is used for connecting the special keys and the LEDs on the front side. If the PC is fitted with Touch Screen (optional), the second serial interface is occupied too.

VGA

VGA connection

A 15-pin SUB-D socket connector (5) allows a VGA monitor to be connected.

USB1 – USB4

USB interfaces

The four USB interfaces (6 – 9) are used to connect peripheral devices with USB connections.

Network

Network connection

The RJ-45 connector (10) allows the PC to be connected to a Local Area Network (LAN).

Sound

Sound-On-Board

The Industrial PC has a on-board-interface with the following connectors: Line In jack (11), Line Out jack (12) and Microphone jack (13).

Type plate

Additional plug-in cards (optional)

A type plate is located on the upper side of the PC, providing information about the Industrial PC equipment as delivered.

Interfaces C33xx-0050

ATX motherboard
interfaces



PS/2 connections

PS/2

The lower PS/2 connector (**X103**) allows a keyboard to be used, while a PS/2 mouse can be connected to the upper PS/2 connector (**X104**). If the PC is fitted with an optional Touch Pad this PS/2 connection is occupied.

Serial interfaces

RS 232
COM1 - COM2

The basic version of the Industrial PC has two serial interfaces, COM1 (**X105**) and COM2, using the type RS 232, which are each brought to a 9 pin SUB-D plug connector. The interface COM2 is located in the first slot right below the ATX-slot.

One of the two serial interfaces is used for connecting the special keys and the LEDs on the front side. If the PC is fitted with Touch Screen (optional), the second serial interface is occupied too.

USB interfaces

USB1 – USB4

The four USB interfaces (**X108 – X111**) are used to connect peripheral devices with USB 2.0 connections.

Network connection

LAN1

The RJ-45 connector (**X112**) allows the PC to be connected to a 10/100/1000BASE-T Local Area Network (LAN).

LAN2

The RJ-45 connector (**X113**) allows the PC to be connected to a 10/100/1000BASE-T Local Area Network (LAN).

Sound-On-Board

Sound

The Industrial PC has a on-board-interface with the following connectors: Line In (**X116**), Line Out (**X115**) and Microphone jack (**X114**).

DVI-I (Digital Visual Interface)

DVI-I out

The DVI connection (**X117**) is used for transferring the video signal. DVI-I standard is supported.

DVI-D (Digital Visual Interface)

DVI-D out

The DVI connection (**X118**) is used for transferring the video signal. DVI-D standard is supported.

DisplayPort

DisplayPort

The DisplayPort (**X119**) is used for transferring the video signal.

Additional plug-in cards (optional)

Type plate

There is a type plate on the top of the Industrial PC which provides information about the hardware configuration of the Industrial PC at the time it was supplied.

Installation Instructions

Please also refer to chapter [Appropriate Use](#).

Transport and Unpacking

The specified storage conditions must be observed (see chapter [Technical data](#)).

Transport

Despite the robust design of the unit, the components are sensitive to strong vibrations and impacts. During transport, your Industrial PC should therefore be protected from excessive mechanical stress. Therefore, please use the original packaging.



Warning

Danger of damage to the unit!

If the device is transported in cold weather or is exposed to extreme variations in temperature, make sure that moisture (condensation) does not form on or inside the device.

Prior to operation, the unit must be allowed to slowly adjust to room temperature. Should condensation occur, a delay time of approximately 12 hours must be allowed before the unit is switched on.

Unpacking

Proceed as follows to unpack the unit:

1. Remove packaging.
2. Do not discard the original packaging. Keep it for future relocation.
3. Check the delivery for completeness by comparing it with your order.
4. Please keep the associated paperwork. It contains important information for handling the unit.
5. Check the contents for visible shipping damage.
6. If you notice any shipping damage or inconsistencies between the contents and your order, you should notify Beckhoff Service.

Installation of the PC in the control cabinet

The C33xx Industrial PC is designed for mounting in control cabinets for machine and plant engineering applications.

The ambient conditions specified for operation must be observed (see chapter [Technical data](#)).

Preparation of the control cabinet

Four holes for the fixing bolts have to be provided in the control cabinet according to the dimensions of the PC (see chapter [Assembly dimensions](#)).



Note

When the unit is installed in an enclosure, adequate space for ventilation and for opening the PC must be provided.

Please note the following points during installation of the PC:

- Position the PC in such a way that reflections on the screen are avoided as far as possible.
- Use the position of the screen as a guide for the correct installation height; it should be optimally visible for the user at all times.
- The PC should not be exposed to direct sunlight.
- When the unit is in its mounting position, the ventilation openings must not be obstructed.



Warning

Extreme environmental conditions should be avoided as far as possible. Protect the PC from dust, moisture and heat.

The ventilation slots of the PC must not be covered.

Earthing measures



Earthing measures

Earthing connections dissipate interference from external power supply cables, signal cables or cables to peripheral equipment.

Establish a low-impedance connection from the earthing point on the PC housing (see photograph on the left) to the central earthing point on the control cabinet wall, in which the computer is being installed.

Power Supply Connection

The 5-pin CAGE CLAMP plug connector and mounting flange illustrated is located on the PC housing in order to connect the power supply.

Socket at the PC housing

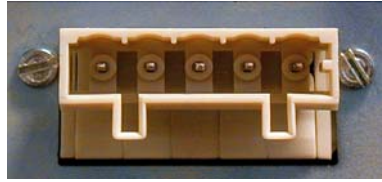

Technical data	Connecting socket
Number of contacts	5
Contact spacing	5 mm
Minimum conductor cross-section	1.5 mm ²
Minimum conductor cross-section (AWG)	16
Rated voltage (EN)	250 V
Rated voltage (CSA)	300 V
Current EN [A]	12 A
Current CSA [A]	15 A
Length of stripped conductor	8 to 9 mm

Supplied mains power unit

The Industrial PC is either fitted with a 100-240 V, 50-60 Hz power supply unit (standard) or with a 24 V_{DC} power supply unit (with the option of an uninterruptible power supply, UPS).

Current carrying capacity of the 100-240 V power supply unit

Current carrying capacity of the 100-240 V power supply unit

Output voltages from the 100-240 V power supply unit	Current loading maximum
+3.3 V	20 A
+5 V stand by	2 A
+5 V	25 A
-5 V	0.3 A
+12 V	13 A
-12 V	0.8 A

Current carrying capacity of the 24 V power supply unit

Current carrying capacity of the 24 V power supply unit

Output voltages from the 24 V power supply unit	Current loading maximum
+5 V	25 A
-5 V	1 A
+12 V	10 A
-12 V	1.5 A

Coding pieces



Differently coded plug connectors

Differently coded Connectors

The connectors are coded differently at the factory, using snap-on coding pieces, according to the power supply unit that has been fitted.

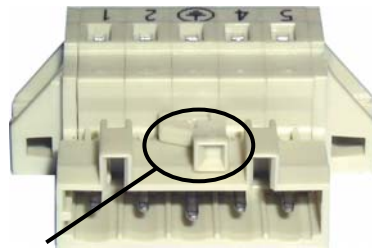

Coding for the 100-240 V_{AC}, 50-60 Hz power supply unit

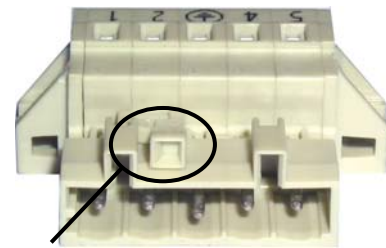

Coding for the 24 V_{DC} power supply unit

Fitting the Power Supply Cable

A 5-pin female plug connector with CAGE CLAMP connection and insertion catches is supplied along with a snap-on strain relief housing in order to assemble the PC power supply cable.

Materials for assembly of the connector



Female plug connector

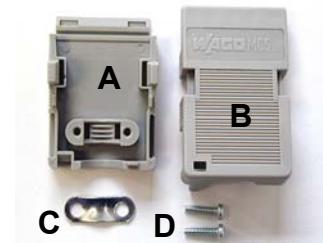

Strain relief housing

Female plug connector is correspondingly coded

This female plug connector is also coded at the factory, according to the type of power supply fitted, so that the plug, when assembled, will fit the Industrial PC's connecting socket.

Technical data	Female plug connector
Number of contacts	5
Contact spacing	5 mm
Minimum conductor cross-section	1.5 mm ²
Minimum conductor cross-section (AWG)	16
Rated voltage (EN)	250 V
Rated voltage (CSA)	300 V
Current (EN)	16 A
Current (CSA)	15 A
Length of stripped conductor	8 to 9 mm

Pin assignment

Pin assignment and cable requirements

There is an adhesive label with the pin assignments on the top of the female plug connector. **The minimum permitted conductive cross-section is 1.5 mm², fused for 10 A (AWG 16).**

Industrial PCs with 100-240 V_{AC}, 50-60 Hz power supply unit

Pin assignment for the 100-240 V, 50-60 Hz power supply unit

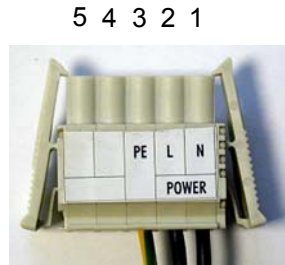

Pin	Function	
1	N	100 – 240V _{AC} Power supply
2	L	
3	⊕	
4	not used	
5	not used	

Industrial PCs with 24 V_{DC} power supply unit

Pin assignment for the 24 V_{DC} power supply unit

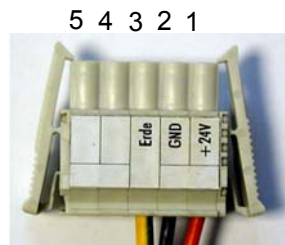

Pin	Function	
1	+	24V _{DC} Power supply
2	-	
3	⊕	
4	not used	
5	not used	

Fitting the connector to the cable

The plug is fitted to the cable as follows:

1. Strip insulation from the cable ends. Follow the technical data for the female plug connector in the above table!
2. Push the conductors into their mountings, simply by pushing them in as indicated on the pin assignment label.
3. Push the lower part (part **A**) of the strain relief housing (see photograph on page 15) onto the top of the female plug connector until it snaps into place.
4. Relieve the strain on the supply cable by fixing it in place with the cable clamp (part **C**) and fixing screws (part **D**) (see photograph below).

Applying the strain relief



Fix the upper part (part **B**) of the strain relief housing by snapping it onto the lower part.

Connecting devices



Warning

The power supply plug must be withdrawn!

Please read the documentation for the external devices prior to connecting them.

During thunderstorms, plug connector must neither be inserted nor removed.

When disconnecting a plug connector, always handle it at the plug. Do not pull the cable!

Connecting cables

The connections are located at the side of the Industrial PC and at the rear (power supply connection), and are documented in the section where the product is described.

When connecting the cables to the Industrial PC, proceed according to the following sequence:

- Switch off all the devices that are to be connected.
- Disconnect all the devices that are to be connected from the power supply.
- Connect all the cables between the Industrial PC and to the devices that are to be connected.
- Connect all data transfer cables (if present) to the appropriate plug-in receptacles of the data/telecommunication networks.
- Reconnect all devices to the power supply.

Check voltage rating and connect

With compact 100-240 V_{AC} 50/60 Hz power supply:

1. Check that the mains voltage is correct.
2. Insert the power supply cable that you have assembled (see the section on [Fitting the Power Supply Cable](#)) into the Industrial PC's power supply socket. Then connect it to a power socket with a grounded earth connection.

When fitted with the (optional) 24 V_{DC} power supply unit:

1. Check that the external power supply is providing the correct voltage.
2. Insert the power supply cable that you have assembled (see the section on [Fitting the Power Supply Cable](#)) into the Industrial PC's power supply socket. Then connect it to your external 24 V power supply.



Warning

If a 24 V UPS is installed, the correct type of rechargeable battery must be used.

Operating Instructions

Please also refer to chapter [Appropriate Use](#).

Switching the Industrial PC on and off

Switch on

The Industrial PC does not have its own mains switch. The Industrial PC will start when the equipment is switched on, or when it is connected to the power supply.

Shutting down and switching off

When the plant is switched off, or when it is disconnected from its power supply, the Industrial PC will be switched off.

Control software such as is typically used on Industrial PCs permits various users to be given different rights. A user who may not close software may also not switch the Industrial PC off, since data can be lost from the hard disk by switching off while software is running.



Warning

First shut down, then switch off the PC!

If the Industrial PC is switched off as the software is writing a file to the hard disk, the file will be destroyed. Control software typically writes something to the hard disk every few seconds, so that the probability of causing damage by switching off while the software is running is very high.



Warning

When you have shut down the Industrial PC, you have to switch off power supply for at least 10 seconds before rebooting the system. After resetting power supply the PC will start booting automatically.

Reset-key

A Reset button (1) for rebooting the system is provided under the front flap below the floppy disk drive.

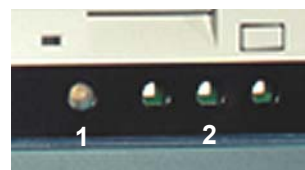

LEDs

Three LEDs are located next to the Reset button (2):

The red LED signals hard disk activity, the green LED signals the presence of the voltage supply, while the yellow LED indicates Turbo operation.

First switching on and driver installation

When you switch on the Industrial PC for the first time, the pre-installed operating system (optional) will be started. In this case, all the required drivers for any additional, optional hardware components ordered with the PC will already have been installed.

If the PC was ordered without operating system, you have to install the operating system and the driver software for any auxiliary hardware yourself. Please follow the instructions in the documentation for the operating system and the additional devices.

Operating the Industrial-PC

Type-dependent number of keys

Depending on the precise type, the Industrial PC can have fewer keys than those described here.

Operation



Description of the keys

The cursor is the blinking character that marks the point at which the next character entered will be displayed. The cursor is also known as the insertion point. The cursor keys each move the cursor one place in the associated direction.



The Home key moves the cursor to the beginning of the line, while the End key moves it to the end of the line.



The *Pg Up* key scrolls one page back, the *Pg Dn* key scrolls one page forward.



The Tab key takes the cursor to the next input field, while Shift and Tab moves to the previous input field.



The mouse cursor can be moved over the screen with the aid of the touch screen or of the touch pad (optional). The keys correspond to the left and right hand keys of a Microsoft mouse.



The *Del* key deletes the character to the right of the cursor.



The *Ins* key causes characters to the right of the cursor to be overwritten. The overwrite mode is cancelled by pressing the key again.



Print-Screen prints a hard copy of a text screen on the printer.



The Pause key stops the computer until another key is pressed (only under MS-DOS).



Your input is confirmed with the Enter key.



Backspace deletes the character to the left of the cursor.



If the Shift key is pressed at the same time as another key, then instead of the numbers you obtain the character printed above the number, and you obtain upper case letters instead of lower case letters.



Pressing the *Caps Lock* key once activates and locks the *Shift* key. Pressing the *Shift* key cancels this function.



Rather like the effect of the *Shift* key, *Ctrl* and *Alt* also change the meaning of another key that is pressed at the same time.



Pressing this key opens the property sheet of the active (or marked) object. (Windows 95, 98, ME, NT, 2000, XP).



Pressing this key opens the property sheet of the active (or marked) object.

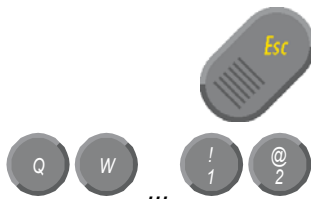

The *Esc* key has the effect of closing dialog windows and of interrupting some of the computer's working operations.

All other keys bring the character printed on them onto the display at the position of the cursor.

Function keys



The meaning of the function keys, *F1* to *F10*, is determined by the software and is displayed at the bottom edge of the display.

Special keys



The function of the special keys left beside the display is also determined by the software. The function is displayed at the top edge of the display or by the marked module strips.

The special keys each have an orange LED controlled by the software.

Maintenance

Please also refer to chapter [Appropriate Use](#).

Cleaning the Industrial PC



Switch off the Industrial PC and all connected devices, and disconnect the Industrial PC from the power supply.

The Industrial PC can be cleaned with a soft, damp cloth. Do not use any aggressive cleaning materials, thinners, scouring material or hard objects that could cause scratches.

Replacing the battery on the motherboard

A used battery on the motherboard has to be replaced.



Danger of Explosion!

Replace battery only with the identical type or an alternative type recommended by the manufacturer. Notice correct polarity!



Handling of Lithium Batteries

Lithium Batteries should not be recharged, exposed to fire, opened and they should be protected against sunlight and moisture.

The used battery must be disposed of in accordance with national electronics scrap regulations.

Servicing

The Industrial PC requires no maintenance.

Shutting down

Disposal

Dismantling the Industrial PC

The device must be fully dismantled in order to dispose of it. The housing can be sent for metal recycling.

Observe national electronics scrap regulations

Electronic parts such as disk drives and circuit boards must be disposed of in accordance with national electronics scrap regulations.

Troubleshooting

Please also refer to chapter *Appropriate Use*.



Note

Pixel errors in the TFT display are production-caused and represent no complaint-reason!

Fault correction

Fault	Cause	Procedure
Nothing happens after the Industrial PC has been switched on	No power supply to the Industrial PC.	Check power supply cable.
	Other cause.	Call Beckhoff Service.
The Industrial PC does not boot fully	Floppy disk or CD in the drive.	Remove floppy disk or CD and press any key.
	Setup settings are incorrect.	Check the setup settings.
	Other cause.	Call Beckhoff Service.
Computer boots, software starts, but control does not operate correctly	Cause of the fault is either in the software or in parts of the plant outside the Industrial PC.	Call the manufacturer of the machine or the software.
Floppy disk or CD access error	Faulty disk or CD.	Check disk or CD in another drive.
	Faulty disk drive.	Call Beckhoff Service.
The Industrial PC functions only partially or only part of the time, e.g. no or dark picture, but disk drive responds when switching on	Defective components in the Industrial PC.	Call Beckhoff Service.

Beckhoff Support and Service

Beckhoff and their partners around the world offer comprehensive support and service, guaranteeing fast and competent assistance with all questions related to Beckhoff products and system solutions.

Beckhoff branches and partner companies

Please contact your Beckhoff branch office or partner company for [local support and service](#) on Beckhoff products!

The contact addresses for your country can be found in the list of Beckhoff branches and partner companies: www.beckhoff.com

You will also find further [documentation](#) for Beckhoff components there.

Beckhoff company headquarters

Beckhoff Automation GmbH & Co.KG
Huelshorstweg 20
33415 Verl
Germany

Phone: +49(0)5246/963-0
Fax: +49(0)5246/963-198
e-mail: info@beckhoff.com
Web: <http://www.beckhoff.de/>

Beckhoff Support

Beckhoff offers you comprehensive technical assistance, helping you not only with the application of individual Beckhoff products, but also with wide-ranging services:

- worldwide support
- design, programming and commissioning of complex automation systems
- training program for Beckhoff system components

Hotline: +49(0)5246/963-157
Fax: +49(0)5246/963-9157
e-mail: support@beckhoff.com

Beckhoff Service

The Beckhoff service center supports you in all matters of after-sales service:

- on-site service
- repair service
- spare parts service
- hotline service

Hotline: +49(0)5246/963-460
Fax: +49(0)5246/963-479
e-mail: mailto:service@beckhoff.com

Quote the project number If servicing is required, please quote the **project number** of your product.

Assembly dimensions

The following pages show diagrams of the Industrial PCs, with dimensions in mm.



Warning

The assembly of the unit must take place with the orientation diagrammed here.

Industrial-PC C3320

screw mounting M3x10

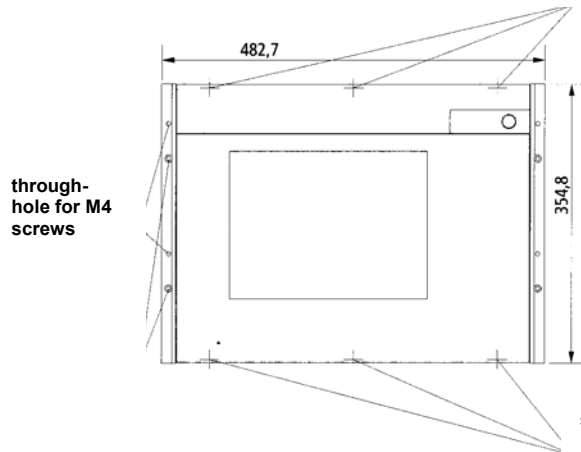

front view

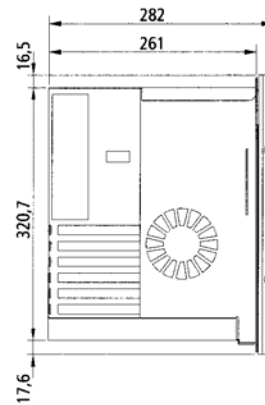

side view

screw mounting M3x10

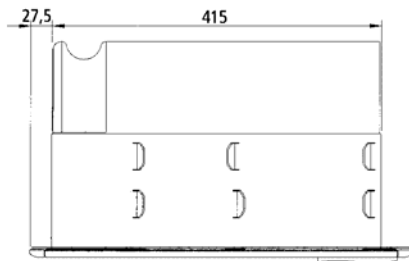

plan view

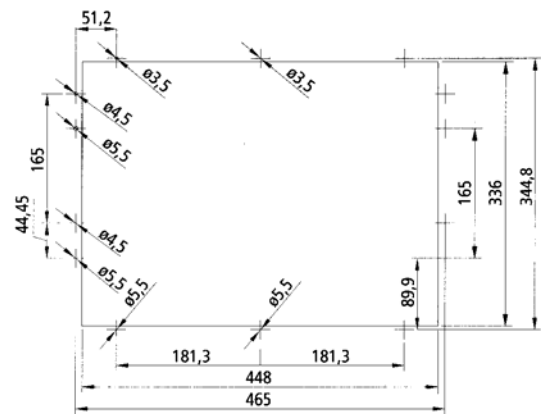

cut out for installation

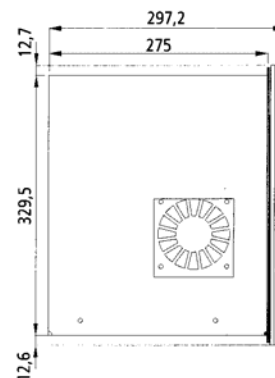
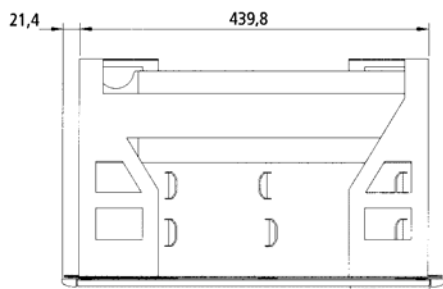



Warning

The assembly of the unit must take place with the orientation diagrammed here.

Industrial-PC C3330

screw mounting M3x10

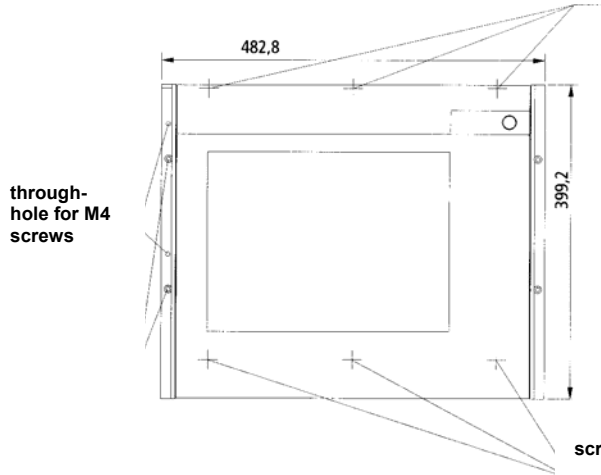

front view

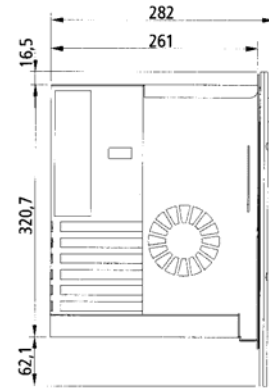

side view

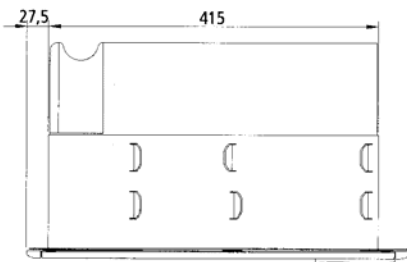

plan view

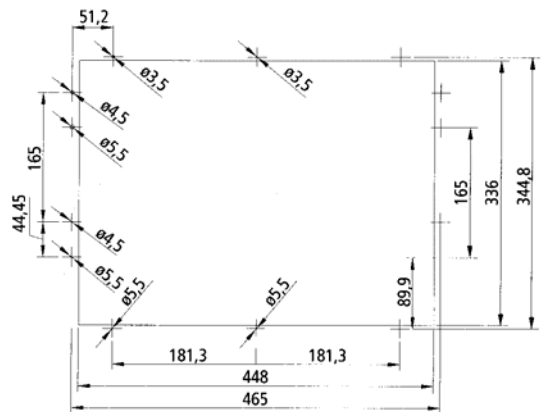

cut out for installation

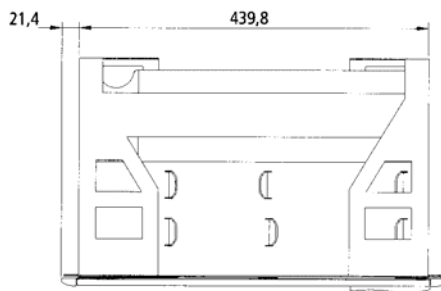

plan view with excerpt-frame for front assembly

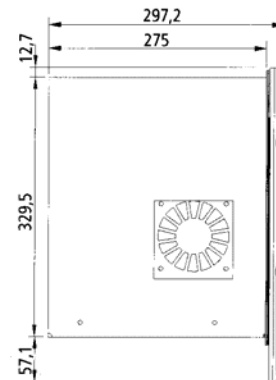

side view with excerpt-frame for front assembly



Warning

The assembly of the unit must take place with the orientation diagrammed here.

Industrial-PC C3340

screw mounting M3x10

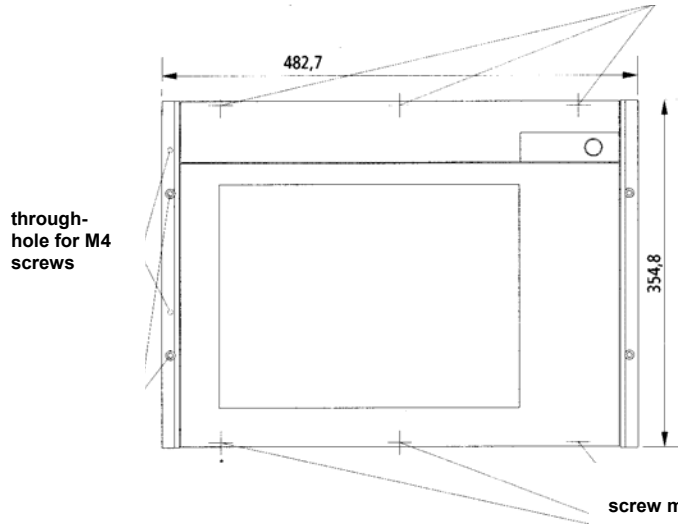

front view

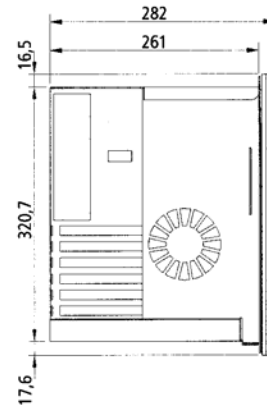

side view

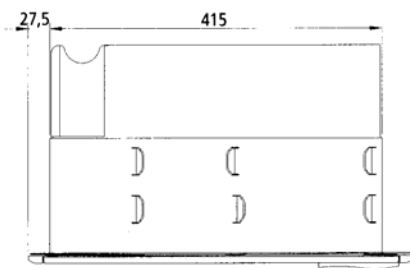

plan view

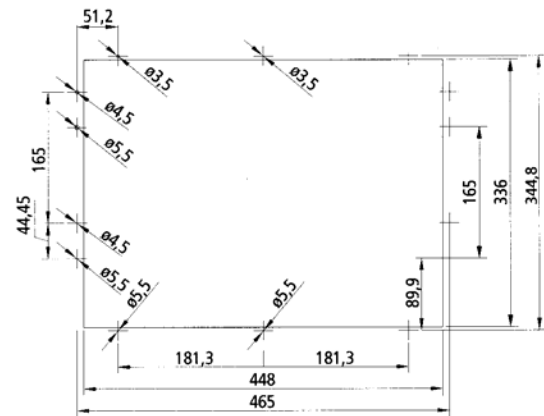

cut out for installation

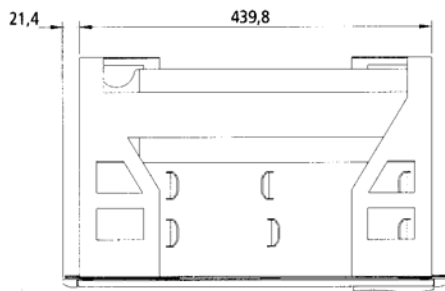

plan view with excerpt-frame for front assembly

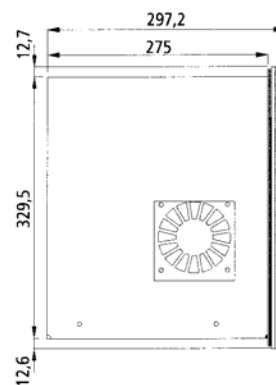

side view with excerpt-frame for front assembly



Warning

The assembly of the unit must take place with the orientation diagrammed here.

Industrial-PC C3350

Gewindebolzen M3x10 im

screw mounting M3x10

through-hole for M4 screws

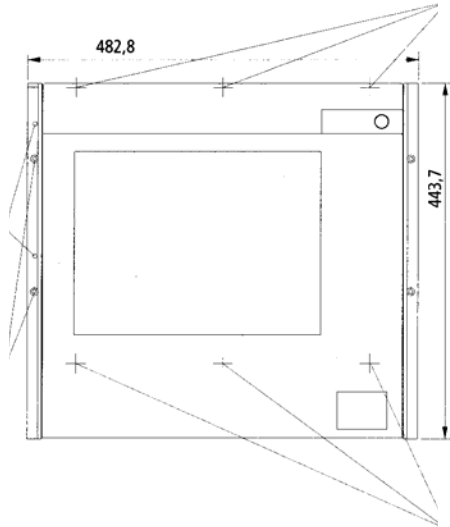

front view

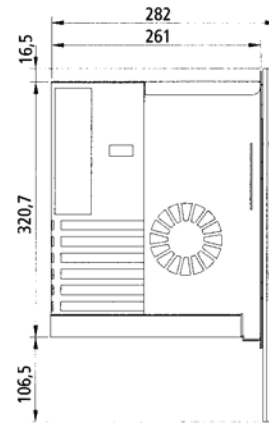

side view

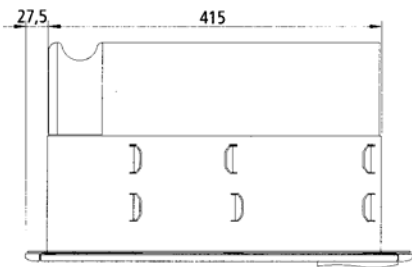

plan view

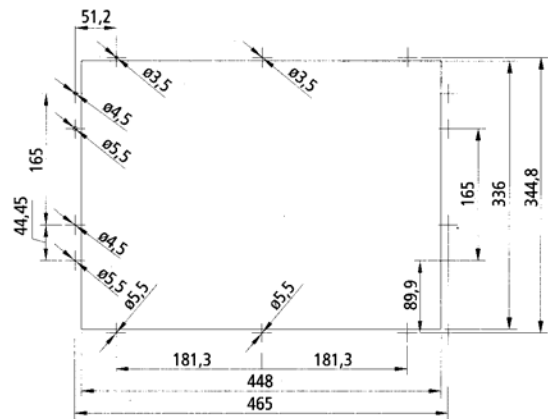

cut out for installation

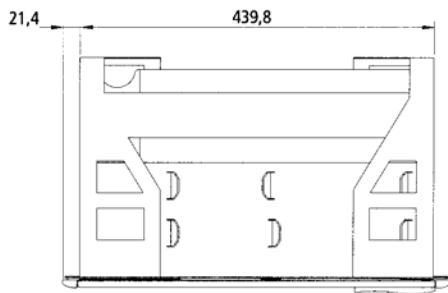

plan view with excerpt-frame for front assembly



side view with excerpt-frame for front assembly

Appendix

Technical data

Industrial-PC C3320

Dimensions (W x H x D): 482.7 x 355 x 282 mm

Weight: 18 kg (basic configuration)

Industrial-PC C3330

Dimensions (W x H x D): 482.7 x 400 x 282 mm

Weight: 18,5 kg (basic configuration)

Industrial-PC C3340

Dimensions (W x H x D): 482.7 x 355 x 282 mm

Weight: 18,5 kg (basic configuration)

Industrial-PC C3350

Dimensions (W x H x D): 482.7 x 444 x 282 mm

Weight: 19 kg (basic configuration)

Do not use the PC in areas of explosive hazard

The Industrial PC may not be used in areas of explosive hazard.

Environmental conditions

The following conditions must be observed during operation:

Ambient temperature: 0 to 55°C

Atmospheric humidity: Maximum 95%, non-condensing

Shock resistance

Sinusoidal vibration: (EN 60068-2-6)

10 to 58 Hz: 0.035 mm

58 to 500 Hz: 0.5 G (~ 5 m/ s²)

During reading of CD-ROM: 10 to 58 Hz: 0.019 mm

58 to 500 Hz: 0.25 G (~ 2.5 m/ s²)

Impact:

(EN 60068-2-27)

5 G (~ 50 m/ s²), duration: 30 ms

During reading of CD-ROM: 5 G (~ 50 m/ s²), duration: 11 ms

Protection class

Protection class: IP 65 (front side), IP20 (back side)

Power supply

Supply voltage: 100-240 V 50-60 Hz

100-240 V_{AC} power pack

Power consumption: 100 W for the basic version

Power supply 24 V_{DC} power pack (optional)

Supply voltage: 22 – 30 V_{DC}

Power consumption: 100 W for the basic version

Electromagnetic Compatibility (EMC)

Interference resistance: according to EN 61000-6-2

Emitted resistance: according to EN 61000-6-4

Transport and storage

The same values for atmospheric humidity and shock resistance are to be observed during transport and storage as in operation. The shock resistance during transport can be improved by means of suitably packing the Industrial PC. The ambient temperature during storage and transport must be between -20°C and +65°C.



Note

Pixel errors in the TFT display are production-caused and represent no complaint-reason!

Approvals

FCC: Federal Communications Commission

Radio Frequency Interference Statement

FCC Approval for USA

This equipment has been tested and found to comply with the limits for a Class A digital device, pursuant to Part 15 of the FCC Rules. These limits are designed to provide reasonable protection against harmful interference when the equipment is operated in a commercial environment. This equipment generates, uses, and can radiate radio frequency energy and, if not installed and used in accordance with the instruction manual, may cause harmful interference to radio communications. Operation of this equipment in a residential area is likely to cause harmful interference in which case the user will be required to correct the interference at his own expense.

FCC: Canadian Notice

FCC Approval for Canada

This equipment does not exceed the Class A limits for radiated emissions as described in the Radio Interference Regulations of the Canadian Department of Communications.