

Documentation | EN

EL31xx

Analog Input Terminals (16 Bit)



Table of contents

1	Foreword	7
1.1	Product overview Analog Input Terminals.....	7
1.2	Notes on the documentation	8
1.3	Guide through documentation.....	9
1.4	Safety instructions.....	10
1.5	Documentation issue status	11
1.6	Version identification of EtherCAT devices	12
1.6.1	General notes on marking.....	12
1.6.2	Version identification of EL terminals.....	13
1.6.3	Beckhoff Identification Code (BIC).....	14
1.6.4	Electronic access to the BIC (eBIC).....	16
2	Product description	18
2.1	EL310x.....	18
2.1.1	EL3101.....	18
2.1.2	EL3102.....	22
2.1.3	EL3104.....	26
2.2	EL311x.....	30
2.2.1	EL3111.....	30
2.2.2	EL3112.....	34
2.2.3	EL3112-0011.....	38
2.2.4	EL3114.....	42
2.3	EL312x.....	46
2.3.1	EL3121.....	46
2.3.2	EL3122.....	50
2.3.3	EL3124.....	54
2.3.4	EL3124-0090.....	58
2.4	EL314x.....	62
2.4.1	EL3141.....	62
2.4.2	EL3142.....	66
2.4.3	EL3142-0010.....	70
2.4.4	EL3144.....	74
2.5	EL315x.....	78
2.5.1	EL3151.....	78
2.5.2	EL3152.....	82
2.5.3	EL3154.....	86
2.6	EL316x.....	90
2.6.1	EL3161.....	90
2.6.2	EL3162.....	93
2.6.3	EL3164.....	96
2.7	EL317x.....	100
2.7.1	EL3172.....	100
2.7.2	EL3174.....	104
2.7.3	EL3174-0002.....	109
2.7.4	EL3174-0030.....	114

2.7.5	EL3174-0032.....	120
2.7.6	EL3174-0042.....	125
2.7.7	EL3174-0090.....	129
2.8	Start.....	135
3	Basics communication	136
3.1	EtherCAT basics	136
3.2	EtherCAT cabling – wire-bound	136
3.3	General notes for setting the watchdog	137
3.4	EtherCAT State Machine	139
3.5	CoE Interface	141
3.6	Distributed Clock	146
4	Mounting and wiring	147
4.1	Instructions for ESD protection	147
4.2	Explosion protection	148
4.2.1	ATEX - Special conditions (standard temperature range).....	148
4.2.2	ATEX - Special conditions (extended temperature range).....	149
4.2.3	IECEX - Special conditions.....	150
4.2.4	Continuative documentation for ATEX and IECEX.....	151
4.2.5	cFMus - Special conditions	152
4.2.6	Continuative documentation for cFMus.....	153
4.3	UL notice	154
4.4	Installation on mounting rails.....	155
4.5	Installation instructions for enhanced mechanical load capacity.....	158
4.6	Connection	159
4.6.1	Connection system.....	159
4.6.2	Wiring	161
4.6.3	Shielding	162
4.7	Note - power supply	163
4.8	Installation positions.....	164
4.9	Positioning of passive Terminals.....	166
4.10	Disposal	167
5	Commissioning	168
5.1	TwinCAT Quick Start.....	168
5.1.1	TwinCAT 2	171
5.1.2	TwinCAT 3	181
5.2	TwinCAT Development Environment	195
5.2.1	Installation of the TwinCAT real-time driver	195
5.2.2	Notes regarding ESI device description	201
5.2.3	TwinCAT ESI Updater	205
5.2.4	Distinction between Online and Offline	205
5.2.5	OFFLINE configuration creation.....	206
5.2.6	ONLINE configuration creation	211
5.2.7	EtherCAT subscriber configuration	219
5.2.8	Import/Export of EtherCAT devices with SCI and XTI.....	229
5.3	General Commissioning Instructions for an EtherCAT Slave	236

5.4	Process data and operation modes	244
5.4.1	Parameterization	244
5.4.2	Settings and operating modes	244
5.4.3	Process data	253
5.4.4	Data stream and measurement ranges.....	261
5.4.5	Fast mode	269
5.5	TwinSAFE SC	272
5.5.1	TwinSAFE SC - operating principle.....	272
5.5.2	TwinSAFE SC - configuration	272
5.5.3	TwinSAFE SC process data EL31x4-0090	276
5.5.4	Objects TwinSAFE Single Channel (EL31x4-0090).....	276
5.6	CoE object description and parameterization	278
5.6.1	EL310x	279
5.6.2	EL311x	306
5.6.3	EL312x	334
5.6.4	EL314x	373
5.6.5	EL315x	401
5.6.6	EL316x	429
5.6.7	EL317x	457
5.7	Error messages and diagnosis.....	482
6	Appendix	483
6.1	EtherCAT AL Status Codes	483
6.2	Firmware compatibility	484
6.3	Firmware Update EL/ES/EM/ELM/EP/EPP/ERPxxxx	491
6.3.1	Device description ESI file/XML	492
6.3.2	Firmware explanation.....	495
6.3.3	Updating controller firmware *.efw	496
6.3.4	FPGA firmware *.rbf	498
6.3.5	Simultaneous updating of several EtherCAT devices	502
6.4	Restoring the delivery state.....	503
6.5	Support and Service.....	505

1 Foreword

1.1 Product overview Analog Input Terminals

[EL3101, EL3102, EL3104](#) [▶ 18]

1, 2 and 4 channel, -10 V to +10 V, differential input

[EL3111, EL3112, EL3114](#) [▶ 30]

1, 2 and 4 channel, 0 mA to 20 mA, differential input

[EL3112-0011](#) [▶ 38]

2 channel, -20 mA to 20 mA, differential input

[EL3121, EL3122, EL3124](#) [▶ 46]

1, 2 and 4 channel, 4 mA to 20 mA, differential input

[EL3124-0090](#) [▶ 58]

4 channel, 4 mA to 20 mA, differential input, TwinSAFE Single Channel

[EL3141, EL3142, EL3144](#) [▶ 62]

1, 2 and 4 channel, 0 mA to 20 mA, single ended

[EL3142-0010](#) [▶ 70]

2 channel, -10 mA to +10 mA, single ended

[EL3151, EL3152, EL3154](#) [▶ 78]

1, 2 and 4 channel, 4 mA to 20 mA, single ended

[EL3161, EL3162, EL3164](#) [▶ 90]

1, 2 and 4 channel, 0 V to 10 V, single ended

[EL3172](#) [▶ 100]

2 channel, -10/0...+10 V, -20/0/+4...+20 mA, switchable, single-ended/ differential input

[EL3174](#) [▶ 104]

4 channel, -10/0...+10 V, -20/0/+4...+20 mA, switchable, single-ended/ differential input

[EL3174-0002](#) [▶ 109]

4 channel, -10/0...+10 V, -20/0/+4...+20 mA, switchable, differential input, electrically isolated

[EL3174-0030](#) [▶ 114]

4 channel, -10/0...+10 V, -20/0/+4...+20 mA, switchable, single-ended/ differential input, external calibration

[EL3174-0032](#) [▶ 120]

4 channel, -3/0...+3 V, -20/0/+4...+20 mA, switchable, differential input, electrically isolated

[EL3174-0042](#) [▶ 125]

4 channel, -30...+30 V, -60...+60 V, switchable, differential input, electrically isolated

[EL3174-0090](#) [▶ 129]

4 channel, -10/0...+10 V, -20/0/+4...+20 mA, switchable, single-ended/ differential input, TwinSAFE Single Channel

1.2 Notes on the documentation

Intended audience

This description is only intended for the use of trained specialists in control and automation engineering who are familiar with the applicable national standards.

It is essential that the documentation and the following notes and explanations are followed when installing and commissioning these components.

The qualified personnel is obliged to always use the currently valid documentation.

The responsible staff must ensure that the application or use of the products described satisfy all the requirements for safety, including all the relevant laws, regulations, guidelines and standards.

Disclaimer

The documentation has been prepared with care. The products described are, however, constantly under development.

We reserve the right to revise and change the documentation at any time and without prior announcement.

No claims for the modification of products that have already been supplied may be made on the basis of the data, diagrams and descriptions in this documentation.

Trademarks

Beckhoff®, TwinCAT®, TwinCAT/BSD®, TC/BSD®, EtherCAT®, EtherCAT G®, EtherCAT G10®, EtherCAT P®, Safety over EtherCAT®, TwinSAFE®, XFC®, XTS® and XPlanar® are registered trademarks of and licensed by Beckhoff Automation GmbH. Other designations used in this publication may be trademarks whose use by third parties for their own purposes could violate the rights of the owners.

Patent Pending

The EtherCAT Technology is covered, including but not limited to the following patent applications and patents: EP1590927, EP1789857, EP1456722, EP2137893, DE102015105702 with corresponding applications or registrations in various other countries.



EtherCAT® is registered trademark and patented technology, licensed by Beckhoff Automation GmbH, Germany.

Copyright

© Beckhoff Automation GmbH & Co. KG, Germany.

The reproduction, distribution and utilization of this document as well as the communication of its contents to others without express authorization are prohibited.

Offenders will be held liable for the payment of damages. All rights reserved in the event of the grant of a patent, utility model or design.

1.3 Guide through documentation

NOTICE	
	<p>Further components of documentation</p> <p>This documentation describes device-specific content. It is part of the modular documentation concept for Beckhoff I/O components. For the use and safe operation of the device / devices described in this documentation, additional cross-product descriptions are required, which can be found in the following table.</p>

Title	Description
EtherCAT System Documentation (PDF)	<ul style="list-style-type: none"> • System overview • EtherCAT basics • Cable redundancy • Hot Connect • EtherCAT devices configuration
I/O Analog Manual (PDF)	Notes on I/O components with analog in and outputs
Explosion Protection for Terminal Systems (PDF)	Notes on the use of the Beckhoff terminal systems in hazardous areas according to ATEX and IECEx
Control Drawing I/O, CX, CPX (PDF)	Connection diagrams and Ex markings (conform to cFMus)
EtherCAT Terminals in the Marine Sector (PDF)	Notes for operation of the Beckhoff EtherCAT Terminal System in the Marine Sector (DNV GL)
Infrastructure for EtherCAT/Ethernet (PDF)	Technical recommendations and notes for design, implementation and testing
Software Declarations I/O (PDF)	Open source software declarations for Beckhoff I/O components

The documentations can be viewed at and downloaded from the Beckhoff website (www.beckhoff.com) via:

- the “Documentation and Download” area of the respective product page,
- the [Download finder](#),
- the [Beckhoff Information System](#).

If you have any suggestions or proposals for our documentation, please send us an e-mail stating the documentation title and version number to: documentation@beckhoff.com

1.4 Safety instructions

Safety regulations

Please note the following safety instructions and explanations!
Product-specific safety instructions can be found on following pages or in the areas mounting, wiring, commissioning etc.

Exclusion of liability

All the components are supplied in particular hardware and software configurations appropriate for the application. Modifications to hardware or software configurations other than those described in the documentation are not permitted, and nullify the liability of Beckhoff Automation GmbH & Co. KG.

Personnel qualification

This description is only intended for trained specialists in control, automation and drive engineering who are familiar with the applicable national standards.

Signal words

The signal words used in the documentation are classified below. In order to prevent injury and damage to persons and property, read and follow the safety and warning notices.

Personal injury warnings

⚠ DANGER

Hazard with high risk of death or serious injury.

⚠ WARNING

Hazard with medium risk of death or serious injury.

⚠ CAUTION

There is a low-risk hazard that could result in medium or minor injury.

Warning of damage to property or environment

NOTICE

The environment, equipment, or data may be damaged.

Information on handling the product



This information includes, for example:
recommendations for action, assistance or further information on the product.

1.5 Documentation issue status

Version	Comment
7.1.0	<ul style="list-style-type: none"> • Update chapter "Technical data" • Update structure
7.0	<ul style="list-style-type: none"> • Update chapter "Connection, display and diagnostics" • Update structure
6.9	<ul style="list-style-type: none"> • EL3174-0042 added • Update structure
6.8	<ul style="list-style-type: none"> • EL3174-0030 added • EL3172 added • Update chapter "Technical data" • Update chapter "LEDs and connection" • Update chapter "Object description" • Update structure • Update revision status
6.7	<ul style="list-style-type: none"> • Update chapter "Technical data" • Update chapter "LEDs and connection" • Update structure
6.6	<ul style="list-style-type: none"> • Update chapter "EL3174, EL3174-0090 - Technical data" • Update chapter "LEDs and connection" • Update revision status
6.5	<ul style="list-style-type: none"> • Chapter "Commissioning": addenda subchapter "Basics about signal isolators, barriers" • Update Chapter "Configuration of 0/4..20 mA differential inputs" • Update structure
6.4	<ul style="list-style-type: none"> • Update chapter "Technical data" • Update structure • Update revision status
6.3	<ul style="list-style-type: none"> • Update chapter "Introduction" • Update structure • Update revision status
6.2	<ul style="list-style-type: none"> • Update chapter "Technical data" • Update chapter "Connection system" -> "Connection" • Update chapter "TwinSAFE SC" • Update structure • Update revision status
6.1	<ul style="list-style-type: none"> • Update chapter "Settings and operation modes" • Update structure
0.1 – 6.0	* archived *

1.6 Version identification of EtherCAT devices

1.6.1 General notes on marking

Designation

A Beckhoff EtherCAT device has a 14-digit designation, made up of

- family key
- type
- version
- revision

Example	Family	Type	Version	Revision
EL3314-0000-0016	EL terminal 12 mm, non-pluggable connection level	3314 4-channel thermocouple terminal	0000 basic type	0016
ES3602-0010-0017	ES terminal 12 mm, pluggable connection level	3602 2-channel voltage measurement	0010 high-precision version	0017
CU2008-0000-0000	CU device	2008 8-port fast ethernet switch	0000 basic type	0000

Notes

- The elements mentioned above result in the **technical designation**. EL3314-0000-0016 is used in the example below.
- EL3314-0000 is the order identifier, in the case of "-0000" usually abbreviated to EL3314. "-0016" is the EtherCAT revision.
- The **order identifier** is made up of
 - family key (EL, EP, CU, ES, KL, CX, etc.)
 - type (3314)
 - version (-0000)
- The **revision** -0016 shows the technical progress, such as the extension of features with regard to the EtherCAT communication, and is managed by Beckhoff.
In principle, a device with a higher revision can replace a device with a lower revision, unless specified otherwise, e.g. in the documentation.
Associated and synonymous with each revision there is usually a description (ESI, EtherCAT Slave Information) in the form of an XML file, which is available for download from the Beckhoff web site.
From 2014/01 the revision is shown on the outside of the IP20 terminals, see Fig. "EL2872 with revision 0022 and serial number 01200815".
- The type, version and revision are read as decimal numbers, even if they are technically saved in hexadecimal.

1.6.2 Version identification of EL terminals

The serial number/ data code for Beckhoff IO devices is usually the 8-digit number printed on the device or on a sticker. The serial number indicates the configuration in delivery state and therefore refers to a whole production batch, without distinguishing the individual modules of a batch.

Structure of the serial number: **KK YY FF HH**

KK - week of production (CW, calendar week)

YY - year of production

FF - firmware version

HH - hardware version

Example with serial number 12 06 3A 02:

12 - production week 12

06 - production year 2006

3A - firmware version 3A

02 - hardware version 02



Fig. 1: EL2872 with revision 0022 and serial number 01200815

1.6.3 Beckhoff Identification Code (BIC)

The Beckhoff Identification Code (BIC) is increasingly being applied to Beckhoff products to uniquely identify the product. The BIC is represented as a Data Matrix Code (DMC, code scheme ECC200), the content is based on the ANSI standard MH10.8.2-2016.



Fig. 2: BIC as data matrix code (DMC, code scheme ECC200)

The BIC will be introduced step by step across all product groups.

Depending on the product, it can be found in the following places:

- on the packaging unit
- directly on the product (if space suffices)
- on the packaging unit and the product

The BIC is machine-readable and contains information that can also be used by the customer for handling and product management.

Each piece of information can be uniquely identified using the so-called data identifier (ANSI MH10.8.2-2016). The data identifier is followed by a character string. Both together have a maximum length according to the table below. If the information is shorter, spaces are added to it.

Following information is possible, positions 1 to 4 are always present, the other according to need of production:

Position	Type of information	Explanation	Data identifier	Number of digits incl. data identifier	Example
1	Beckhoff order number	Beckhoff order number	1P	8	1P 072222
2	Beckhoff Traceability Number (BTN)	Unique serial number, see note below	SBTN	12	SBTN k4p562d7
3	Article description	Beckhoff article description, e.g. EL1008	1K	32	1K EL1809
4	Quantity	Quantity in packaging unit, e.g. 1, 10, etc.	Q	6	Q1
5	Batch number	Optional: Year and week of production	2P	14	2P 401503180016
6	ID/serial number	Optional: Present-day serial number system, e.g. with safety products	51S	12	51S 678294
7	Variant number	Optional: Product variant number on the basis of standard products	30P	32	30P F971, 2*K183
...					

Further types of information and data identifiers are used by Beckhoff and serve internal processes.

Structure of the BIC

Example of composite information from positions 1 to 4 and with the above given example value on position 6. The data identifiers are highlighted in bold font:

1P072222**SBTN**k4p562d7**1K**EL1809 **Q1** **51S**678294

Accordingly as DMC:



Fig. 3: Example DMC **1P**072222**SBTN**k4p562d7**1K**EL1809 **Q1** **51S**678294

BTN

An important component of the BIC is the Beckhoff Traceability Number (BTN, position 2). The BTN is a unique serial number consisting of eight characters that will replace all other serial number systems at Beckhoff in the long term (e.g. batch designations on IO components, previous serial number range for safety products, etc.). The BTN will also be introduced step by step, so it may happen that the BTN is not yet coded in the BIC.

NOTICE

This information has been carefully prepared. However, the procedure described is constantly being further developed. We reserve the right to revise and change procedures and documentation at any time and without prior notice. No claims for changes can be made from the information, illustrations and descriptions in this documentation.

1.6.4 Electronic access to the BIC (eBIC)

Electronic BIC (eBIC)

The Beckhoff Identification Code (BIC) is applied to the outside of Beckhoff products in a visible place. If possible, it should also be electronically readable.

The interface that the product can be electronically addressed by is crucial for the electronic readout.

K-bus devices (IP20, IP67)

Currently, no electronic storage or readout is planned for these devices.

EtherCAT devices (IP20, IP67)

All Beckhoff EtherCAT devices have an ESI-EEPROM which contains the EtherCAT identity with the revision number. The EtherCAT slave information, also colloquially known as the ESI/XML configuration file for the EtherCAT master, is stored in it. See the corresponding chapter in the EtherCAT system manual ([Link](#)) for the relationships.

Beckhoff also stores the eBIC in the ESI-EEPROM. The eBIC was introduced into Beckhoff IO production (terminals, box modules) in 2020; as of 2023, implementation is largely complete.

The user can electronically access the eBIC (if present) as follows:

- With all EtherCAT devices, the EtherCAT master (TwinCAT) can read the eBIC from the ESI-EEPROM
 - From TwinCAT 3.1 build 4024.11, the eBIC can be displayed in the online view.
 - To do this, check the "Show Beckhoff Identification Code (BIC)" checkbox under EtherCAT → Advanced Settings → Diagnostics:

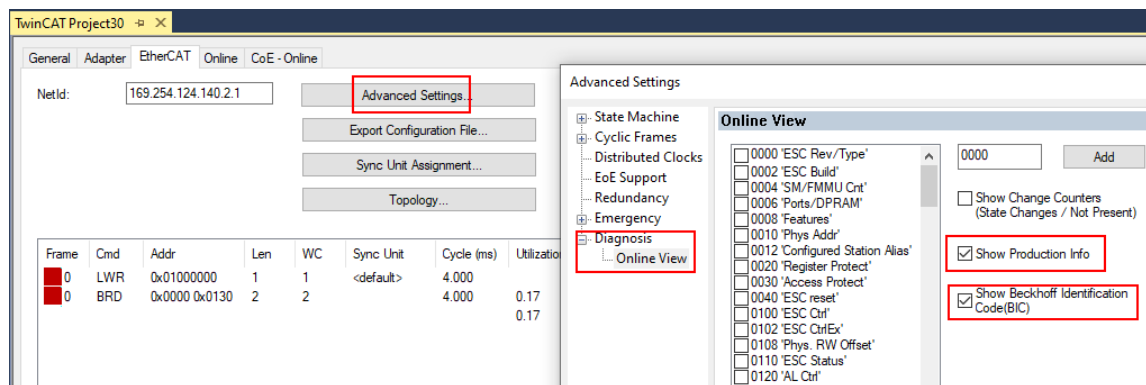

- The BTN and its contents are then displayed:

No	Addr	Name	State	CRC	Fw	Hw	Production Data	ItemNo	BTN	Description	Quantity	BatchNo	SerialNo
1	1001	Term 1 (EK1100)	OP	0.0	0	0	---						
2	1002	Term 2 (EL1018)	OP	0.0	0	0	2020 KW36 Fr	072222	k4p562d7	EL1809	1		678294
3	1003	Term 3 (EL3204)	OP	0.0	7	6	2012 KW24 Sa						
4	1004	Term 4 (EL2004)	OP	0.0	0	0	---	072223	k4p562d7	EL2004	1		678295
5	1005	Term 5 (EL1008)	OP	0.0	0	0	---						
6	1006	Term 6 (EL2008)	OP	0.0	0	12	2014 KW14 Mo						
7	1007	Term 7 (EK1110)	OP	0	1	8	2012 KW25 Mo						

- Note: As shown in the figure, the production data HW version, FW version, and production date, which have been programmed since 2012, can also be displayed with "Show production info".
- Access from the PLC: From TwinCAT 3.1. build 4024.24, the functions *FB_EcReadBIC* and *FB_EcReadBTN* for reading into the PLC are available in the *Tc2_EtherCAT* library from v3.3.19.0.
- EtherCAT devices with a CoE directory may also have the object 0x10E2:01 to display their own eBIC, which can also be easily accessed by the PLC:

- The device must be in PREOP/SAFEOP/OP for access:

Index	Name	Flags	Value
1000	Device type	RO	0x015E1389 (22942601)
1008	Device name	RO	ELM3704-0000
1009	Hardware version	RO	00
100A	Software version	RO	01
100B	Bootloader version	RO	J0.1.27.0
1011:0	Restore default parameters	RO	> 1 <
1018:0	Identity	RO	> 4 <
10E2:0	Manufacturer-specific Identification C...	RO	> 1 <
10E2:01	SubIndex 001	RO	1P158442SBTN0008jckp1KELM3704 Q1 2P482001000016
10F0:0	Backup parameter handling	RO	> 1 <
10F3:0	Diagnosis History	RO	> 21 <
10F8	Actual Time Stamp	RO	0x170bfb277e

- The object 0x10E2 will be preferentially introduced into stock products in the course of necessary firmware revision.
- From TwinCAT 3.1. build 4024.24, the functions *FB_EcCoEReadBIC* and *FB_EcCoEReadBTN* for reading into the PLC are available in the *Tc2_EtherCAT* library from v3.3.19.0
- The following auxiliary functions are available for processing the BIC/BTN data in the PLC in *Tc2_Uilities* as of TwinCAT 3.1 build 4024.24
 - *F_SplitBIC*: The function splits the Beckhoff Identification Code (BIC) *sBICValue* into its components using known identifiers and returns the recognized substrings in the *ST_SplittedBIC* structure as a return value
 - *BIC_TO_BTN*: The function extracts the BTN from the BIC and returns it as a return value
- Note: If there is further electronic processing, the BTN is to be handled as a string(8); the identifier "SBTN" is not part of the BTN.
- Technical background
 The new BIC information is written as an additional category in the ESI-EEPROM during device production. The structure of the ESI content is largely dictated by the ETG specifications, therefore the additional vendor-specific content is stored using a category in accordance with the ETG.2010. ID 03 tells all EtherCAT masters that they may not overwrite these data in the event of an update or restore the data after an ESI update.
 The structure follows the content of the BIC, see here. The EEPROM therefore requires approx. 50..200 bytes of memory.
- Special cases
 - If multiple hierarchically arranged ESCs are installed in a device, only the top-level ESC carries the eBIC information.
 - If multiple non-hierarchically arranged ESCs are installed in a device, all ESCs carry the eBIC information.
 - If the device consists of several sub-devices which each have their own identity, but only the top-level device is accessible via EtherCAT, the eBIC of the top-level device is located in the CoE object directory 0x10E2:01 and the eBICs of the sub-devices follow in 0x10E2:nn.

PROFIBUS; PROFINET, and DeviceNet devices

Currently, no electronic storage or readout is planned for these devices.

2 Product description

2.1 EL310x

2.1.1 EL3101

2.1.1.1 EL3101 - Introduction

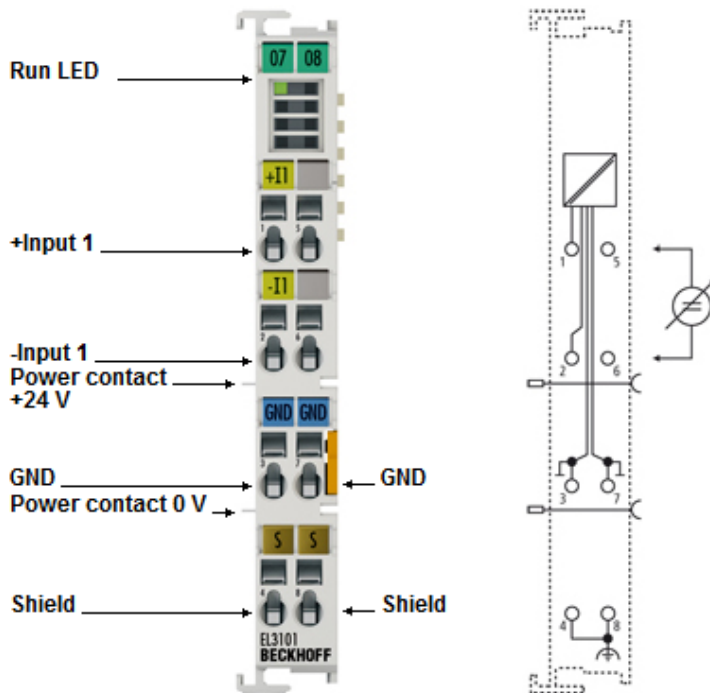

Fig. 4: EL3101

Analog Input Terminal; 1 channel, voltage, ± 10 V, 16 bit, differential

The EL3101 analog input terminal handles signals in the range between -10 and +10 V. The voltage is digitized to a resolution of 16 bits, and is transmitted, electrically isolated, to the higher-level automation device.

The input channels of the EtherCAT Terminal have differential inputs and possess a common, internal ground potential. The signal state of the EtherCAT Terminal is indicated by light emitting diodes.

Quick-Links

- [EtherCAT basics](#)
- [Process data and operating modes \[► 244\]](#)
- [Object description and parameterization \[► 279\]](#)

2.1.1.2 EL3101 - Technical data

Technical data	EL3101
Analog inputs	1
Signal voltage	-10 V ... +10 V
Internal resistance	> 200 kΩ
Resolution	16 bit (including sign)
Sampling type	simultaneous
Ground reference	differential
Conversion time (without filter)	approx. 40 μs
Input filter limit frequency	5 kHz
Measuring error (full measuring range)	< ± 0.3% (at 0 °C ... +55 °C, relative to the full scale value) < ± 0.5% (when the extended temperature range is used)
Supply voltage for electronic	via the E-bus
Current consumption via E-bus	typ. 130 mA
Distributed Clocks	yes
Distributed Clocks precision	<< 1 μs
Support NoCoEStorage [▶ 142]	yes
Electrical isolation	500 V (E-bus/field voltage)
Common mode voltage U_{cm}	max. 35 V (referring to internal GND)
Bit width of the process image (default setting)	Inputs: 1 x 16 bit; Status: 1 x 8 bit
Configuration	no address or configuration settings required
Weight	approx. 60 g
Permissible ambient temperature range during operation	-25°C ... +60°C (extended temperature range)
Permissible ambient temperature range during storage	-40°C ... +85°C
Permissible relative humidity	95%, no condensation
Dimensions (W x H x D)	approx. 15 mm x 100 mm x 70 mm (width aligned: 12 mm)
Mounting [▶ 155]	on 35 mm mounting rail conforms to EN 60715
Enhanced mechanical load capacity	yes, see also Installation instructions for enhanced mechanical load capacity [▶ 158]
Vibration/shock resistance	conforms to EN 60068-2-6 / EN 60068-2-27
EMC immunity/emission	conforms to EN 61000-6-2 / EN 61000-6-4
Protection class	IP20
Installation position	variable
Marking / Approval*)	CE, EAC, UKCA ATEX [▶ 149], IECEx [▶ 150], cULus [▶ 154]

*) Real applicable approvals/markings see type plate on the side (product marking).

Ex markings

Standard	Marking
ATEX	II 3 G Ex nA IIC T4 Gc
IECEX	Ex nA IIC T4 Gc

2.1.1.3 EL3101 - Connection, display and diagnostics

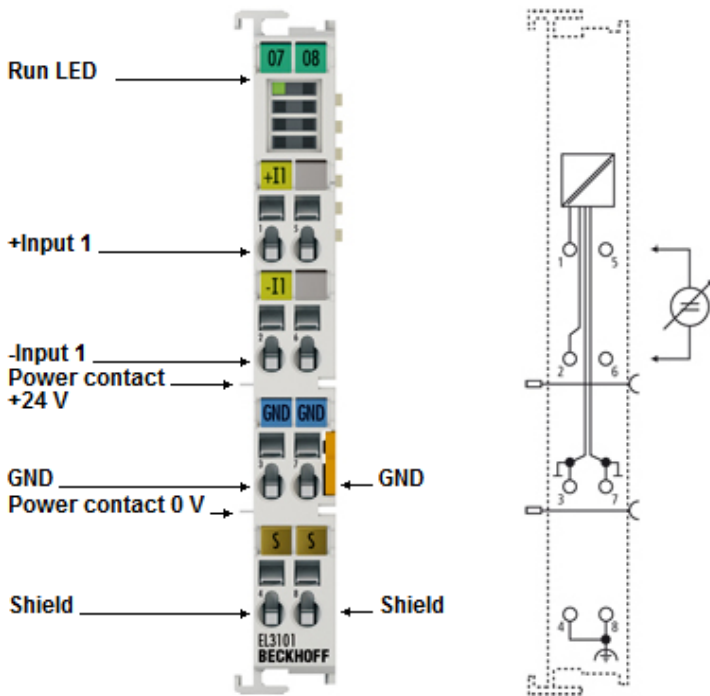

Fig. 5: EL3101 - LEDs and connection

Connection EL3101				
Terminal point		Description	Internally connected with connection	Max. current carrying capacity *)
Name	No.			
+ Input 1	1	+ Input 1	-	not applicable (voltage input)
- Input 1	2	- Input 1	-	not applicable (voltage input)
GND	3	Signal ground for input 1	7, (high impedance, therefore potential equal but not current loadable)	40 mA
Shield	4	Shield (FE)	8; DIN rail	100 mA **)
n. c.	5	not connected	-	-
n.c.	6	not connected	-	-
GND	7	Signal ground for input 1	3, (high impedance, therefore potential equal but not current loadable)	40 mA
Shield	8	Shield (FE)	4; DIN rail	100 mA **)

*) Constant and peak value

**) Shield lines should be de-energized!

● GND connection points

i The GND connection points of the terminal are not connected internally directly, but via EMC protection components. Therefore, each analog encoder/sensor must be connected separately with 2 wires, even if the connection diagram of the terminal for the channels indicates a common ground (GND).

● Current carrying capacity of the input contacts

i The maximum permitted current on the signal-relevant terminal points (inputs, GND) is 40 mA (if applicable).

NOTICE

Terminal GND and system GND

The signal ground GND of this terminal is not internally connected to the negative power contact. This design allows GND to be connected to a ground other than the negative power contact "Power contact 0V" if necessary.

If disturbing potential differences occur, GND must be electrically connected to the system GND or another suitable ground.

LEDs			
LED	Color	Meaning	
RUN*	green	This LED indicates the terminal's operating state (if more than one RUN LED is present, all of them have the same function):	
		off	State of the EtherCAT State Machine [▶ 139] : INIT = initialization of the terminal or BOOTSTRAP = function for firmware updates [▶ 491] of the terminal
		flashing	State of the EtherCAT State Machine: PREOP = function for mailbox communication and different standard-settings set
		single flash	State of the EtherCAT State Machine: SAFEOP = verification of the Sync Manager [▶ 219] channels and the distributed clocks. Outputs remain in safe state
		on	State of the EtherCAT State Machine: OP = normal operating state; mailbox and process data communication is possible
*) If several RUN LEDs are present, all of them have the same function			

2.1.2 EL3102

2.1.2.1 EL3102 - Introduction

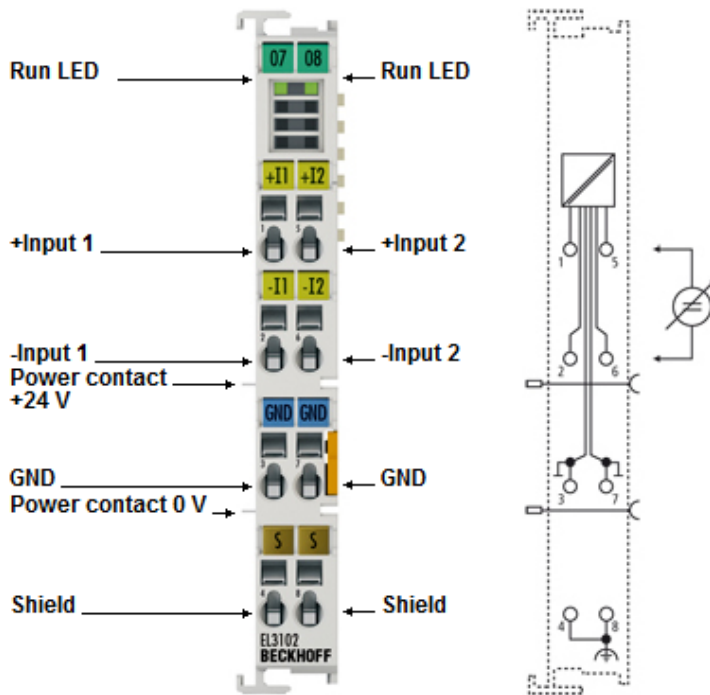

Fig. 6: EL3102

Analog Input Terminal; 2 channel, voltage, ± 10 V, 16 bit, differential

The EL3102 analog input terminal handles signals in the range between -10 and +10 V. The voltage is digitized to a resolution of 16 bits, and is transmitted, electrically isolated, to the higher-level automation device.

The input channels of the EtherCAT Terminal have differential inputs and possess a common, internal ground potential. The signal state of the EtherCAT Terminal is indicated by light emitting diodes..

Quick-Links

- [EtherCAT basics](#)
- [Process data and operating modes \[► 244\]](#)
- [Object description and parameterization \[► 286\]](#)

2.1.2.2 EL3102 - Technical data

Technical data	EL3102
Analog inputs	2
Signal voltage	-10 V ... +10 V
Internal resistance	> 200 kΩ
Resolution	16 bit (including sign)
Sampling type	simultaneous
Ground reference	differential
Conversion time (without filter)	approx. 60 μs (Fast mode: approx. 40 μs)
Input filter limit frequency	5 kHz
Measuring error (full measuring range)	< ± 0.3% (at 0 °C ... +55 °C, relative to the full scale value) < ± 0.5% (when the extended temperature range is used)
Supply voltage for electronic	via the E-bus
Current consumption via E-bus	typ. 170 mA
Distributed Clocks	yes (from rev. EL310x-0000-0017 [▶ 484])
Distributed Clocks precision	<< 1 μs
Support NoCoEStorage [▶ 142]	yes
Electrical isolation	500 V (E-bus/field voltage)
Common mode voltage U_{cm}	max. 35 V (referring to internal GND)
Bit width of the process image (default setting)	Inputs: 2 x 16 bit; Status: 2 x 8 bit
Configuration	no address or configuration settings required
Weight	approx. 60 g
Permissible ambient temperature range during operation	-25°C ... +60°C (extended temperature range)
Permissible ambient temperature range during storage	-40°C ... +85°C
Permissible relative humidity	95%, no condensation
Dimensions (W x H x D)	approx. 15 mm x 100 mm x 70 mm (width aligned: 12 mm)
Mounting [▶ 155]	on 35 mm mounting rail conforms to EN 60715
Enhanced mechanical load capacity	yes, see also Installation instructions for enhanced mechanical load capacity [▶ 158]
Vibration/shock resistance	conforms to EN 60068-2-6 / EN 60068-2-27
EMC immunity/emission	conforms to EN 61000-6-2 / EN 61000-6-4
Protection class	IP20
Installation position	variable
Marking / Approval ^{*)}	CE, EAC, UKCA ATEX [▶ 149], IECEx [▶ 150], cULus [▶ 154]

*) Real applicable approvals/markings see type plate on the side (product marking).

Ex markings

Standard	Marking
ATEX	II 3 G Ex nA IIC T4 Gc
IECEx	Ex nA IIC T4 Gc

2.1.2.3 EL3102 - Connection, display and diagnostics

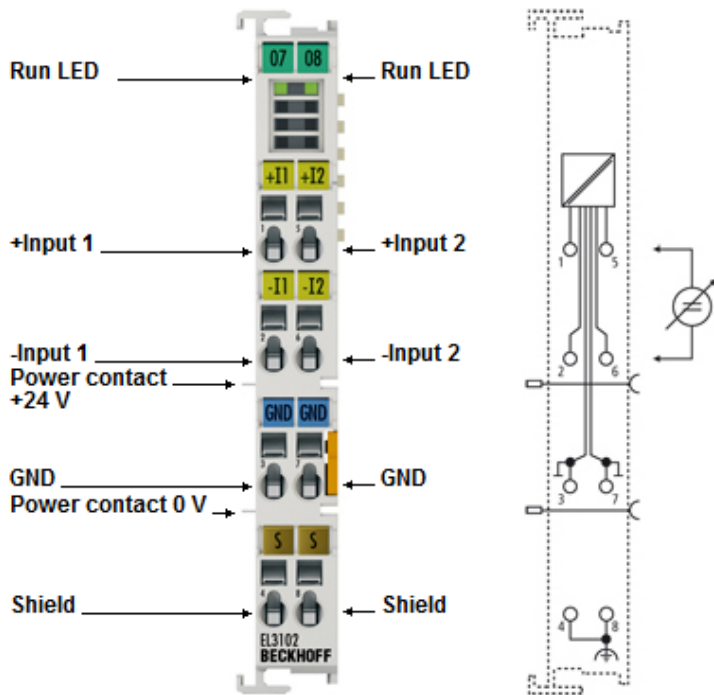

Fig. 7: EL3102 - LEDs and connection

Connection EL3102				
Terminal point		Description	Internally connected with connection	Max. current carrying capacity *)
Name	No.			
+ Input 1	1	+ Input 1	-	not applicable (voltage input)
- Input 1	2	- Input 1	-	not applicable (voltage input)
GND	3	Signal ground for Input 1	7, (high impedance, therefore potential equal but not current loadable)	40 mA
Shield	4	Shield (FE)	8; DIN rail	100 mA **)
+ Input 2	5	+ Input 2	-	not applicable (voltage input)
- Input 2	6	- Input 2	-	not applicable (voltage input)
GND	7	Signal ground for Input 2	3, (high impedance, therefore potential equal but not current loadable)	40 mA
Shield	8	Shield (FE)	4; DIN rail	100 mA **)

*) Constant and peak value

**) Shield lines should be de-energized!

● GND connection points

i The GND connection points of the terminal are not connected internally directly, but via EMC protection components. Therefore, each analog encoder/sensor must be connected separately with 2 wires, even if the connection diagram of the terminal for the channels indicates a common ground (GND).

● Current carrying capacity of the input contacts

i The maximum permitted current on the signal-relevant terminal points (inputs, GND) is 40 mA (if applicable).

NOTICE

Terminal GND and system GND

The signal ground GND of this terminal is not internally connected to the negative power contact. This design allows GND to be connected to a ground other than the negative power contact "Power contact 0V" if necessary.

If disturbing potential differences occur, GND must be electrically connected to the system GND or another suitable ground.

LEDs			
LED	Color	Meaning	
RUN*	green	This LED indicates the terminal's operating state (if more than one RUN LED is present, all of them have the same function):	
		off	State of the EtherCAT State Machine [▶ 139] : INIT = initialization of the terminal or BOOTSTRAP = function for firmware updates [▶ 491] of the terminal
		flashing	State of the EtherCAT State Machine: PREOP = function for mailbox communication and different standard-settings set
		single flash	State of the EtherCAT State Machine: SAFEOP = verification of the Sync Manager [▶ 219] channels and the distributed clocks. Outputs remain in safe state
		on	State of the EtherCAT State Machine: OP = normal operating state; mailbox and process data communication is possible
*) If several RUN LEDs are present, all of them have the same function			

2.1.3 EL3104

2.1.3.1 EL3104 - Introduction

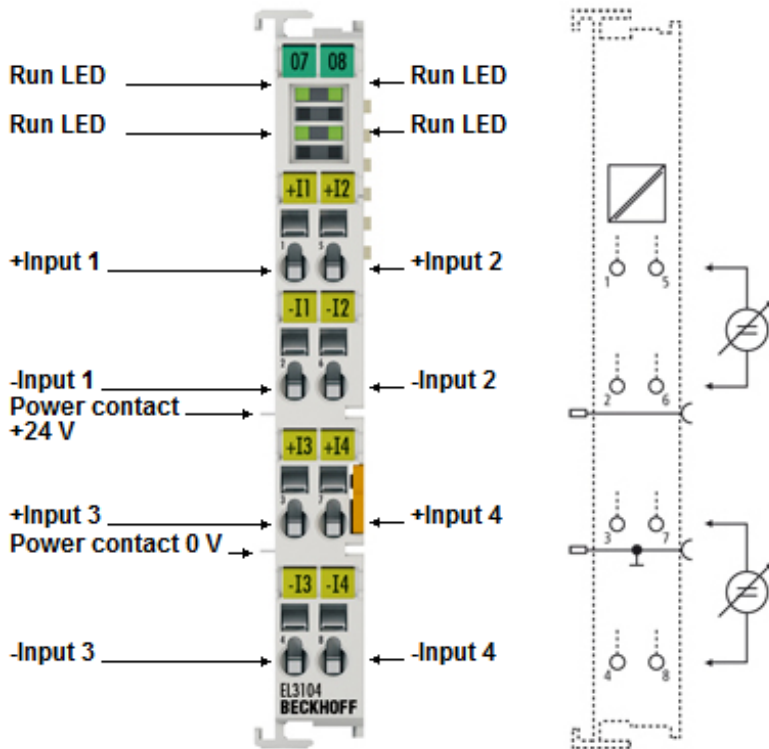

Fig. 8: EL3104

Analog Input Terminal; 4 channel, voltage, ± 10 V, 16 bit, differential

The EL3104 analog input terminal processes signals in the range between -10 and +10 V. The voltage is digitized to a resolution of 16 bits, and is transmitted, electrically isolated, to the higher-level automation device.

The input channels of the EL3104 EtherCAT Terminal are differential inputs. The signal state of the EtherCAT Terminal is indicated by light emitting diodes.

Quick-Links

- [EtherCAT basics](#)
- [Process data and operation modes \[► 244\]](#)
- [Object description and parameterization \[► 297\]](#)

2.1.3.2 EL3104 - Technical data

Technical data	EL3104
Analog inputs	4
Signal voltage	-10 V ... +10 V
Internal resistance	> 200 kΩ
Resolution	16 bit (including sign)
Sampling type	multiplex
Ground reference	differential
Conversion time (without filter)	approx. 100 μs
Input filter limit frequency	5 kHz
Measuring error (full measuring range)	< ± 0.3% (at 0 °C ... +55 °C, relative to the full scale value) < ± 0.5% (when the extended temperature range is used)
Supply voltage for electronic	via the E-bus
Current consumption via E-bus	typ. 130 mA
Distributed Clocks	yes
Distributed Clocks precision	<< 1 μs
Support NoCoEStorage [▶ 142]	yes
Electrical isolation	500 V (E-bus/field voltage)
Common mode voltage U_{cm}	max. 35 V (referring to power contact)
Bit width of the process image (default setting)	Inputs: 4 x 16 bit; Status: 4 x 8 bit
Configuration	no address or configuration settings required
Weight	approx. 65 g
Permissible ambient temperature range during operation	-25°C ... +60°C (extended temperature range)
Permissible ambient temperature range during storage	-40°C ... +85°C
Permissible relative humidity	95%, no condensation
Dimensions (W x H x D)	approx. 15 mm x 100 mm x 70 mm (width aligned: 12 mm)
Mounting [▶ 155]	on 35 mm mounting rail conforms to EN 60715
Enhanced mechanical load capacity	yes, see also Installation instructions for enhanced mechanical load capacity [▶ 158]
Vibration/shock resistance	conforms to EN 60068-2-6 / EN 60068-2-27
EMC immunity/emission	conforms to EN 61000-6-2 / EN 61000-6-4
Protection class	IP20
Installation position	variable
Marking / Approval ^{*)}	CE, EAC, UKCA ATEX [▶ 149], IECEX [▶ 150], cFMus [▶ 152] cULus [▶ 154]

*) Real applicable approvals/markings see type plate on the side (product marking).

Ex markings

Standard	Marking
ATEX	II 3 G Ex nA IIC T4 Gc II 3 D Ex tc IIIC T135 °C Dc
IECEX	Ex nA IIC T4 Gc Ex tc IIIC T135 °C Dc
cFMus	Class I, Division 2, Groups A, B, C, D Class I, Zone 2, AEx/Ex ec IIC T4 Gc

2.1.3.3 EL3104 - Connection, display and diagnostics

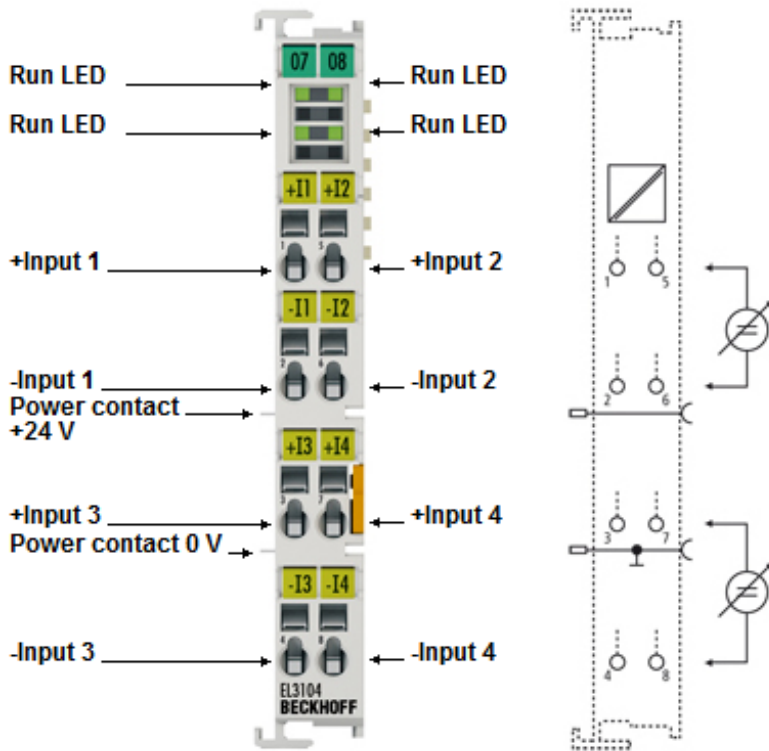

Fig. 9: EL3104 - LEDs and connection

Connection EL3104				
Terminal point		Description	Internally connected with connection	Max. current carrying capacity *)
Name	No.			
+ Input 1	1	+ Input 1	-	not applicable (voltage input)
- Input 1	2	- Input 1	-	not applicable (voltage input)
+ Input 3	3	+ Input 3	-	not applicable (voltage input)
- Input 3	4	- Input 3	-	not applicable (voltage input)
+ Input 2	5	+ Input 2	-	not applicable (voltage input)
- Input 2	6	- Input 2	-	not applicable (voltage input)
+ Input 4	7	+ Input 4	-	not applicable (voltage input)
- Input 4	8	- Input 4	-	not applicable (voltage input)

*) Constant and peak value

● GND connection points

i The GND connection points of the terminal are not connected internally directly, but via EMC protection components. Therefore, each analog encoder/sensor must be connected separately with 2 wires, even if the connection diagram of the terminal for the channels indicates a common ground (GND).

● Current carrying capacity of the input contacts

i The maximum permitted current on the signal-relevant terminal points (inputs, GND) is 40 mA (if applicable).

LEDs			
LED	Color	Meaning	
RUN*	green	This LED indicates the terminal's operating state (if more than one RUN LED is present, all of them have the same function):	
		off	State of the EtherCAT State Machine [▶ 139] : INIT = initialization of the terminal or BOOTSTRAP = function for firmware updates [▶ 491] of the terminal
		flashing	State of the EtherCAT State Machine: PREOP = function for mailbox communication and different standard-settings set
		single flash	State of the EtherCAT State Machine: SAFEOP = verification of the Sync Manager [▶ 219] channels and the distributed clocks. Outputs remain in safe state
		on	State of the EtherCAT State Machine: OP = normal operating state; mailbox and process data communication is possible
*) If several RUN LEDs are present, all of them have the same function			

2.2 EL311x

2.2.1 EL3111

2.2.1.1 EL3111 - Introduction

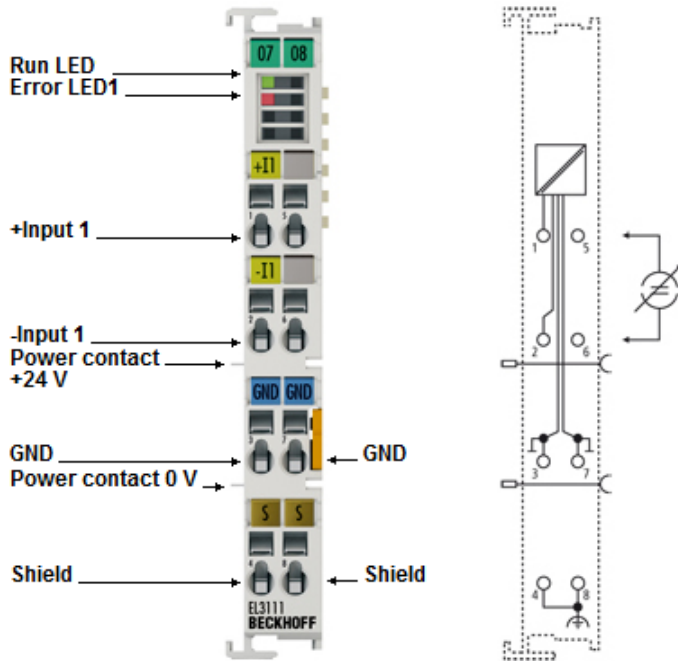

Fig. 10: EL3111

Analog Input Terminal; 1 channel, current, 0...20 mA, 16 bit, differential

The EL3111 analog input terminal processes signals in the range between 0 and 20 mA. The current is digitized to a resolution of 16 bits and is transmitted, electrically isolated, to the higher-level automation device.

The input channels of the EtherCAT Terminal have differential inputs and possess a common, internal ground potential. The EL3111 is the single-channel version and is characterized by its fine granularity and electrical isolation.

Overload condition is detected, and the terminal status is relayed to the controller via the E-bus. The EtherCAT Terminal indicates its signal state by means of light emitting diodes. The error LEDs indicate an overload condition.

Quick-Links

- [EtherCAT basics](#)
- [Process data and operating modes \[► 244\]](#)
- [Object description and parameterization \[► 306\]](#)

2.2.1.2 EL3111 - Technical data

Technical data	EL3111
Analog inputs	1
Signal current	0 mA...20 mA
Internal resistance	85 Ω type. + diode voltage
Resolution	16 bit (including sign)
Sampling type	simultaneous
Ground reference	differential
Conversion time (default setting: 50 Hz filter)	approx. 40 µs
Input filter limit frequency	5 kHz
Measuring error (full measuring range)	< ± 0.3% (at 0 °C ... +55 °C, relative to the full scale value) < ± 0.5% (when the extended temperature range is used)
Supply voltage for electronic	via the E-bus
Current consumption via E-bus	typ. 130 mA
Distributed Clocks	yes
Distributed Clocks precision	<< 1 µs
Support NoCoEStorage [▶ 142]	yes
Electrical isolation	500 V (E-bus/field voltage)
Common mode voltage U _{cm}	max. 10 V
Bit width of the process image (default setting)	Inputs: 1 x 16 bit; Status: 1 x 8 bit
Configuration	no address or configuration settings required
Weight	approx. 55 g
Permissible ambient temperature range during operation	-25°C ... +60°C (extended temperature range)
Permissible ambient temperature range during storage	-40°C ... +85°C
Permissible relative humidity	95%, no condensation
Dimensions (W x H x D)	approx. 15 mm x 100 mm x 70 mm (width aligned: 12 mm)
Mounting [▶ 155]	on 35 mm mounting rail conforms to EN 60715
Enhanced mechanical load capacity	yes, see also Installation instructions for enhanced mechanical load capacity [▶ 158]
Vibration/shock resistance	conforms to EN 60068-2-6 / EN 60068-2-27
EMC immunity/emission	conforms to EN 61000-6-2 / EN 61000-6-4
Protection class	IP20
Installation position	variable
Marking / Approval ^{*)}	CE, EAC, UKCA ATEX [▶ 149], IECEx [▶ 150], cULus [▶ 154]

*) Real applicable approvals/markings see type plate on the side (product marking).

Ex markings

Standard	Marking
ATEX	II 3 G Ex nA IIC T4 Gc
IECEX	Ex nA IIC T4 Gc

2.2.1.3 EL3111 - Connection, display and diagnostics

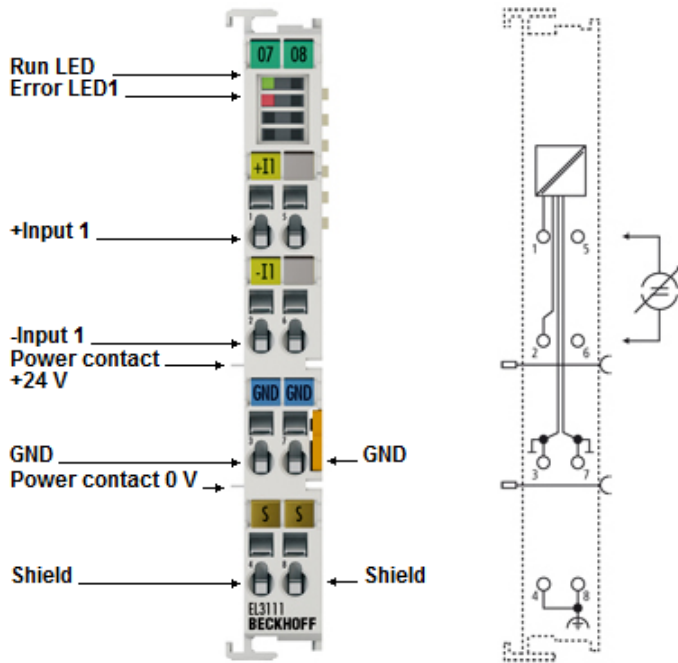

Fig. 11: EL3111 - LEDs and connection

Connection EL3111				
Terminal point		Description	Internally connected with connection	Max. current carrying capacity *)
Name	No.			
+ Input 1	1	+ Input 1	-	40 mA
- Input 1	2	- Input 1	-	40 mA
GND	3	Signal ground for input 1	7, (high impedance, therefore potential equal but not current loadable)	40 mA
Shield	4	Shield (FE)	8; DIN rail	100 mA **)
n. c.	5	not connected	-	-
n.c.	6	not connected	-	-
GND	7	Signal ground for input 1	3, (high impedance, therefore potential equal but not current loadable)	40 mA
Shield	8	Shield (FE)	4; DIN rail	100 mA **)

*) Constant and peak value

**) Shield lines should be de-energized!

● GND connection points

i The GND connection points of the terminal are not connected internally directly, but via EMC protection components. Therefore, each analog encoder/sensor must be connected separately with 2 wires, even if the connection diagram of the terminal for the channels indicates a common ground (GND).

● Current carrying capacity of the input contacts

i The maximum permitted current on the signal-relevant terminal points (inputs, GND) is 40 mA (if applicable).

NOTICE

Terminal GND and system GND

The signal ground GND of this terminal is not internally connected to the negative power contact. This design allows GND to be connected to a ground other than the negative power contact "Power contact 0V" if necessary.

If disturbing potential differences occur, GND must be electrically connected to the system GND or another suitable ground.

● Overcurrent protection of the 20 mA inputs

i The current inputs are protected against damage by overcurrent by an internal current limitation, currents > 30mA may occur. In the event of a fault, the current limiter must not be overloaded by a voltage > 30V from the source device.

Overcurrent is displayed in the process image as "Overrange". After occurrence, the error condition must be stopped immediately, the source device switched off or disconnected from the input terminal. If the error condition persists for a longer period of time, the internal terminal current limitation reduces the absorbed signal current for thermal reasons, depending on the ambient conditions also below 20 mA.

LEDs			
LED	Color	Meaning	
RUN*	green	This LED indicates the terminal's operating state *:	
		off	State of the EtherCAT State Machine [▶ 139] : INIT = initialization of the terminal or BOOTSTRAP = function for firmware updates [▶ 491] of the terminal
		flashing	State of the EtherCAT State Machine: PREOP = function for mailbox communication and different standard-settings set
		single flash	State of the EtherCAT State Machine: SAFEOP = verification of the Sync Manager [▶ 219] channels and the distributed clocks. Outputs remain in safe state
		on	State of the EtherCAT State Machine: OP = normal operating state; mailbox and process data communication is possible
ERROR**	red	Fault indication in the event of undershooting or overshooting of the measuring range	
*) If several RUN LEDs are present, all of them have the same function			
**) The error display shows the signal processing state for each channel			

2.2.2 EL3112

2.2.2.1 EL3112 - Introduction

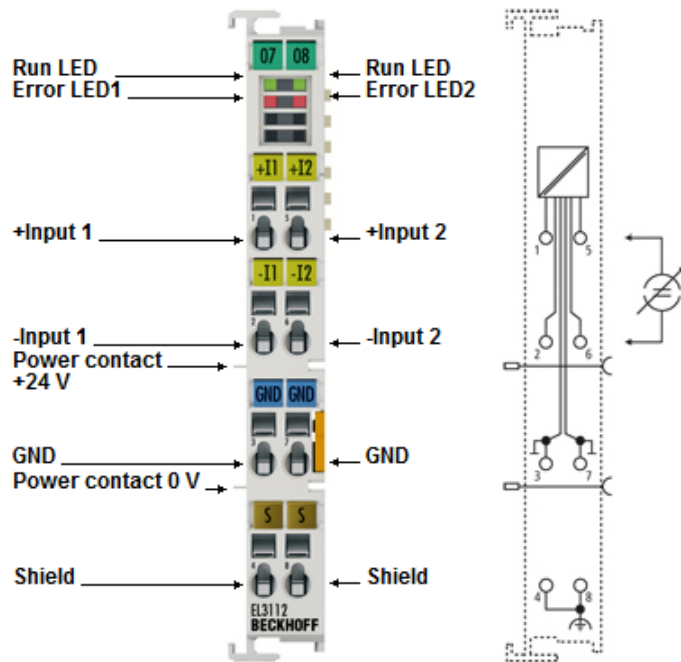

Fig. 12: EL3112

Analog Input Terminal; 2 channel, current, 0...20 mA, 16 bit, differential

The EL3112 analog input terminal processes signals in the range between 0 and 20 mA. The current is digitized to a resolution of 16 bits and is transmitted, electrically isolated, to the higher-level automation device.

The input channels of the EtherCAT Terminal have differential inputs and possess a common, internal ground potential. The EL3112 combines two channels in one housing.

Overload condition is detected, and the terminal status is relayed to the controller via the E-bus. The EtherCAT Terminal indicates its signal state by means of light emitting diodes. The error LEDs indicate an overload condition..

Quick-Links

- [EtherCAT basics](#)
- [Process data and operating modes \[► 244\]](#)
- [Object description and parameterization \[► 313\]](#)

2.2.2.2 EL3112 - Technical data

Technical data	EL3112
Analog inputs	2
Signal current	0 mA...20 mA
Internal resistance	85 Ω type. + diode voltage
Resolution	16 bit (including sign)
Sampling type	simultaneous
Ground reference	differential
Conversion time (default setting: 50 Hz filter)	approx. 50 μs (Fast mode: approx. 35 μs)
Input filter limit frequency	5 kHz
Measuring error (full measuring range)	< ± 0.3% (at 0 °C ... +55 °C, relative to the full scale value) < ± 0.5% (when the extended temperature range is used)
Supply voltage for electronic	via the E-bus
Current consumption via E-bus	typ. 170 mA
Distributed Clocks	yes (from rev. EL311x-0000-0017 [▶ 484])
Distributed Clocks precision	<< 1 μs
Support NoCoEStorage [▶ 142]	yes
Electrical isolation	500 V (E-bus/field voltage)
Common mode voltage U _{cm}	max. 10 V
Bit width of the process image (default setting)	Inputs: 2 x 16 bit; Status: 2 x 8 bit
Configuration	no address or configuration settings required
Weight	approx. 55 g
Permissible ambient temperature range during operation	-25°C ... +60°C (extended temperature range)
Permissible ambient temperature range during storage	-40°C ... +85°C
Permissible relative humidity	95%, no condensation
Dimensions (W x H x D)	approx. 15 mm x 100 mm x 70 mm (width aligned: 12 mm)
Mounting [▶ 155]	on 35 mm mounting rail conforms to EN 60715
Enhanced mechanical load capacity	yes, see also Installation instructions for enhanced mechanical load capacity [▶ 158]
Vibration/shock resistance	conforms to EN 60068-2-6 / EN 60068-2-27
EMC immunity/emission	conforms to EN 61000-6-2 / EN 61000-6-4
Protection class	IP20
Installation position	variable
Marking / Approval	CE, EAC, UKCA ATEX [▶ 149], IECEx [▶ 150], cULus [▶ 154]

*) Real applicable approvals/markings see type plate on the side (product marking).

Ex markings

Standard	Marking
ATEX	II 3 G Ex nA IIC T4 Gc
IECEX	Ex nA IIC T4 Gc

2.2.2.3 EL3112 - Connection, display and diagnostics

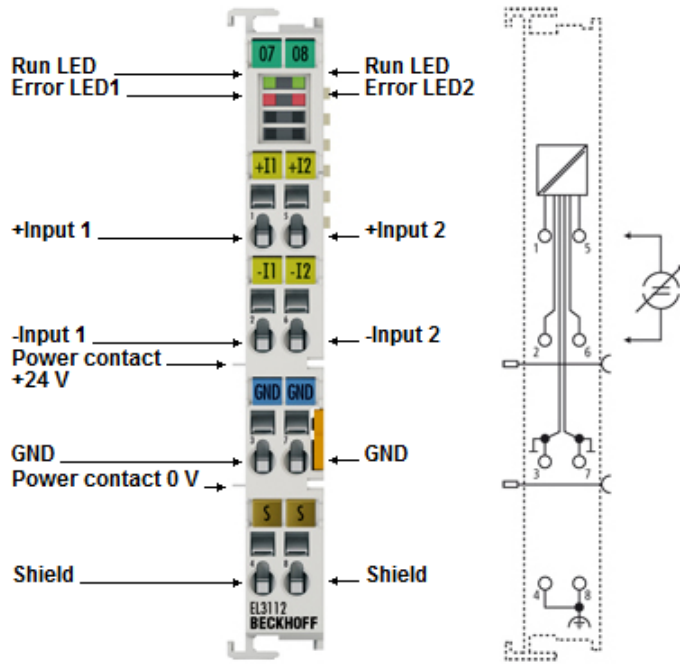

Fig. 13: EL3112 - LEDs and connection

Connection EL3112, EL3112-0011				
Terminal point		Description	Internally connected with connection	Max. current carrying capacity *)
Name	No.			
+ Input 1	1	+ Input 1	-	40 mA
- Input 1	2	- Input 1	-	40 mA
GND	3	Signal ground for input 1	7, (high impedance, therefore potential equal but not current loadable)	40 mA
Shield	4	Shield (FE)	8; DIN rail	100 mA **)
+ Input 2	5	+ Input 2	-	40 mA
- Input 2	6	- Input 2	-	40 mA
GND	7	Signal ground for input 2	3, (high impedance, therefore potential equal but not current loadable)	40 mA
Shield	8	Shield (FE)	4; DIN rail	100 mA **)

*) Constant and peak value

**) Shield lines should be de-energized!

● GND connection points

i The GND connection points of the terminal are not connected internally directly, but via EMC protection components. Therefore, each analog encoder/sensor must be connected separately with 2 wires, even if the connection diagram of the terminal for the channels indicates a common ground (GND).

● Current carrying capacity of the input contacts

i The maximum permitted current on the signal-relevant terminal points (inputs, GND) is 40 mA (if applicable).

NOTICE

Terminal GND and system GND

The signal ground GND of this terminal is not internally connected to the negative power contact. This design allows GND to be connected to a ground other than the negative power contact "Power contact 0V" if necessary.

If disturbing potential differences occur, GND must be electrically connected to the system GND or another suitable ground.

● Overcurrent protection of the 20 mA inputs

i The current inputs are protected against damage by overcurrent by an internal current limitation, currents > 30mA may occur. In the event of a fault, the current limiter must not be overloaded by a voltage > 30V from the source device.

Overcurrent is displayed in the process image as "Overrange". After occurrence, the error condition must be stopped immediately, the source device switched off or disconnected from the input terminal. If the error condition persists for a longer period of time, the internal terminal current limitation reduces the absorbed signal current for thermal reasons, depending on the ambient conditions also below 20 mA.

LEDs			
LED	Color	Meaning	
RUN*	green	This LED indicates the terminal's operating state *:	
		off	State of the EtherCAT State Machine [▶ 139] : INIT = initialization of the terminal or BOOTSTRAP = function for firmware updates [▶ 491] of the terminal
		flashing	State of the EtherCAT State Machine: PREOP = function for mailbox communication and different standard-settings set
		single flash	State of the EtherCAT State Machine: SAFEOP = verification of the Sync Manager [▶ 219] channels and the distributed clocks. Outputs remain in safe state
		on	State of the EtherCAT State Machine: OP = normal operating state; mailbox and process data communication is possible
ERROR**	red	Fault indication in the event of undershooting or overshooting of the measuring range	
*) If several RUN LEDs are present, all of them have the same function			
**) The error display shows the signal processing state for each channel			

2.2.3 EL3112-0011

2.2.3.1 EL3112-0011 - Introduction

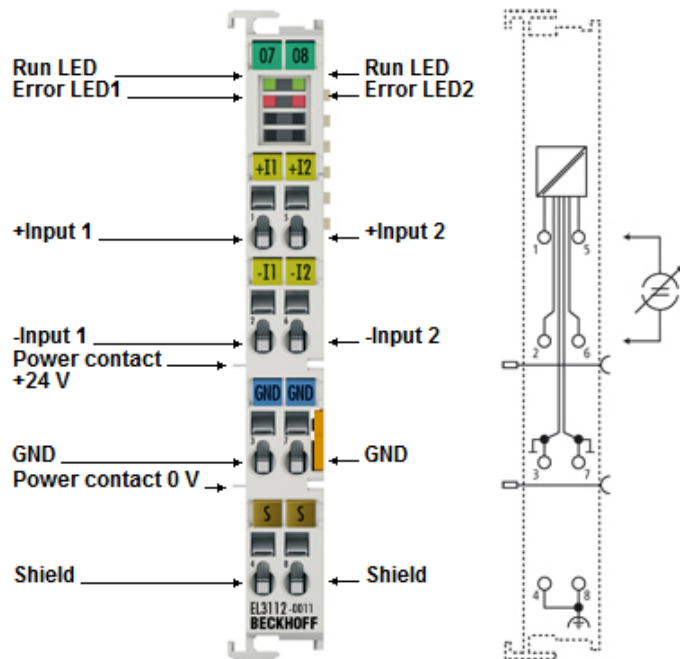

Fig. 14: EL3112-0011

Analog Input Terminal; 2 channel, current, ± 20 mA, 16 bit, differential

The EL3112-0011 analog input terminal processes signals in the range between -20 and +20 mA. The current is digitized to a resolution of 16 bits and is transmitted, electrically isolated, to the higher-level automation device.

The input channels of the EtherCAT Terminal have differential inputs and possess a common, internal ground potential. The EL3112-0011 combines two channels in one housing.

Overload condition is detected, and the terminal status is relayed to the controller via the E-bus. The error LEDs indicate an overload condition.

Quick-Links

- [EtherCAT basics](#)
- [Process data and operating modes \[► 244\]](#)
- [Object description and parameterization \[► 313\]](#)

2.2.3.2 EL3112-0011 - Technical data

Technical data	EL3112-0011
Analog inputs	2
Signal current	-20 mA...20 mA
Internal resistance	85 Ω type. + diode voltage
Resolution	16 bit (including sign)
Sampling type	simultaneous
Ground reference	differential
Conversion time (default setting: 50 Hz filter)	approx. 50 μs (Fast mode: approx. 35 μs)
Input filter limit frequency	5 kHz
Measuring error (full measuring range)	< ± 0.3% (at 0 °C ... +55 °C, relative to the full scale value) < ± 0.5% (when the extended temperature range is used)
Supply voltage for electronic	via the E-bus
Current consumption via E-bus	typ. 170 mA
Distributed Clocks	yes
Distributed Clocks precision	<< 1 μs
Support NoCoEStorage [▶ 142]	yes
Electrical isolation	500 V (E-bus/field voltage)
Common mode voltage U _{cm}	max. 10 V
Bit width of the process image (default setting)	Inputs: 2 x 16 bit; Status: 2 x 8 bit
Configuration	no address or configuration settings required
Weight	approx. 55 g
Permissible ambient temperature range during operation	-25°C ... +60°C (extended temperature range)
Permissible ambient temperature range during storage	-40°C ... +85°C
Permissible relative humidity	95%, no condensation
Dimensions (W x H x D)	approx. 15 mm x 100 mm x 70 mm (width aligned: 12 mm)
Mounting [▶ 155]	on 35 mm mounting rail conforms to EN 60715
Enhanced mechanical load capacity	yes, see also Installation instructions for enhanced mechanical load capacity [▶ 158]
Vibration/shock resistance	conforms to EN 60068-2-6 / EN 60068-2-27
EMC immunity/emission	conforms to EN 61000-6-2 / EN 61000-6-4
Protection class	IP20
Installation position	variable
Marking / Approval ^{*)}	CE, EAC, UKCA ATEX [▶ 149], IECEx [▶ 150], cULus [▶ 154]

*) Real applicable approvals/markings see type plate on the side (product marking).

Ex markings

Standard	Marking
ATEX	II 3 G Ex nA IIC T4 Gc
IECEx	Ex nA IIC T4 Gc

2.2.3.3 EL3112-0011 - Connection, display and diagnostics

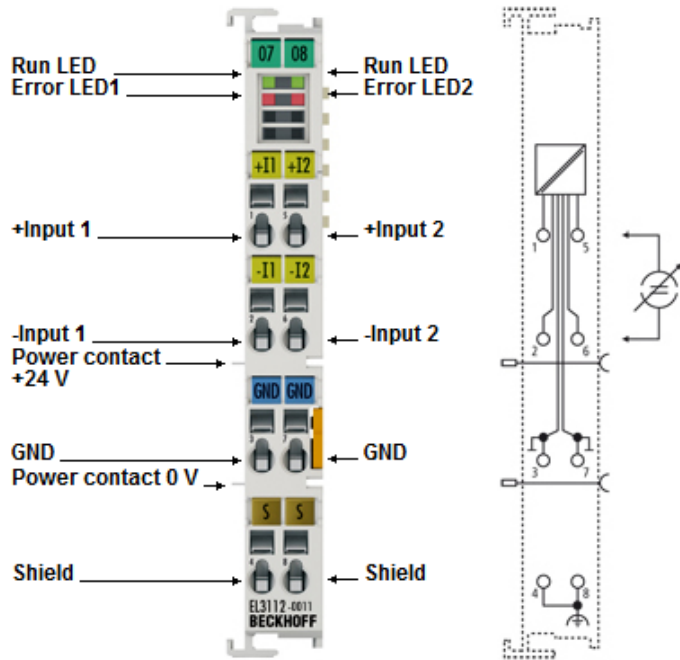

Fig. 15: EL3112-0011 – LEDs and connection

Connection EL3112, EL3112-0011				
Terminal point		Description	Internally connected with connection	Max. current carrying capacity *)
Name	No.			
+ Input 1	1	+ Input 1	-	40 mA
- Input 1	2	- Input 1	-	40 mA
GND	3	Signal ground for input 1	7, (high impedance, therefore potential equal but not current loadable)	40 mA
Shield	4	Shield (FE)	8; DIN rail	100 mA **)
+ Input 2	5	+ Input 2	-	40 mA
- Input 2	6	- Input 2	-	40 mA
GND	7	Signal ground for input 2	3, (high impedance, therefore potential equal but not current loadable)	40 mA
Shield	8	Shield (FE)	4; DIN rail	100 mA **)

*) Constant and peak value

**) Shield lines should be de-energized!

● GND connection points

i The GND connection points of the terminal are not connected internally directly, but via EMC protection components. Therefore, each analog encoder/sensor must be connected separately with 2 wires, even if the connection diagram of the terminal for the channels indicates a common ground (GND).

● Current carrying capacity of the input contacts

i The maximum permitted current on the signal-relevant terminal points (inputs, GND) is 40 mA (if applicable).

NOTICE

Terminal GND and system GND

The signal ground GND of this terminal is not internally connected to the negative power contact. This design allows GND to be connected to a ground other than the negative power contact "Power contact 0V" if necessary.

If disturbing potential differences occur, GND must be electrically connected to the system GND or another suitable ground.

● Overcurrent protection of the 20 mA inputs

i The current inputs are protected against damage by overcurrent by an internal current limitation, currents > 30mA may occur. In the event of a fault, the current limiter must not be overloaded by a voltage > 30V from the source device.

Overcurrent is displayed in the process image as "Overrange". After occurrence, the error condition must be stopped immediately, the source device switched off or disconnected from the input terminal. If the error condition persists for a longer period of time, the internal terminal current limitation reduces the absorbed signal current for thermal reasons, depending on the ambient conditions also below 20 mA.

LEDs			
LED	Color	Meaning	
RUN*	green	This LED indicates the terminal's operating state *:	
		off	State of the EtherCAT State Machine [▶ 139] : INIT = initialization of the terminal or BOOTSTRAP = function for firmware updates [▶ 491] of the terminal
		flashing	State of the EtherCAT State Machine: PREOP = function for mailbox communication and different standard-settings set
		single flash	State of the EtherCAT State Machine: SAFEOP = verification of the Sync Manager [▶ 219] channels and the distributed clocks. Outputs remain in safe state
		on	State of the EtherCAT State Machine: OP = normal operating state; mailbox and process data communication is possible
ERROR**	red	Fault indication in the event of undershooting or overshooting of the measuring range	
*) If several RUN LEDs are present, all of them have the same function			
**) The error display shows the signal processing state for each channel			

2.2.4 EL3114

2.2.4.1 EL3114 - Introduction

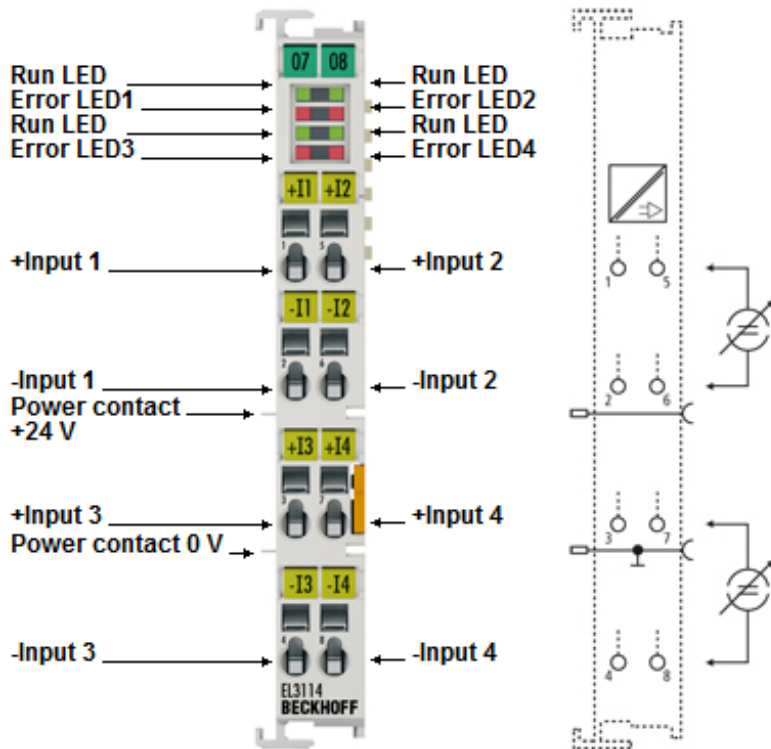

Fig. 16: EL3114

Analog Input Terminal; 4 channel, current, 0...20 mA, 16 bit, differential

The EL3114 analog input terminal processes signals in the range between 0 and 20 mA.

The current is digitized to a resolution of 16 bits and is transmitted, electrically isolated, to the higher-level automation device. The input channels of the EtherCAT Terminal have differential inputs and possess a common, internal ground potential.

Overload condition is detected, and the terminal status is relayed to the controller via the E-bus. The EtherCAT Terminal indicates its signal state by means of light emitting diodes..

Quick-Links

- [EtherCAT basics](#)
- [Process data and operation modes \[► 244\]](#)
- [Object description and parameterization \[► 325\]](#)

2.2.4.2 EL3114 - Technical data

Technical data	EL3114
Analog inputs	4 (differential)
Signal current	0 mA...20 mA
Internal resistance	85 Ω type. + diode voltage
Resolution	16 bit (including sign)
Sampling type	multiplex
Ground reference	differential
Conversion time (default setting: 50 Hz filter)	approx. 100 µs
Input filter limit frequency	5 kHz
Measuring error (full measuring range)	< ± 0.3% (at 0 °C ... +55 °C, relative to the full scale value) < ± 0.5% (when the extended temperature range is used)
Supply voltage for electronic	via the E-bus
Current consumption via E-bus	typ. 130 mA
Distributed Clocks	yes
Distributed Clocks precision	<< 1 µs
Support NoCoEStorage [▶ 142]	yes
Electrical isolation	500 V (E-bus/field voltage)
Common mode voltage U_{cm}	max. 10 V
Bit width of the process image (default setting)	Inputs: 4 x 16 bit; Status: 4 x 8 bit
Configuration	no address or configuration settings required
Weight	approx. 55 g
Permissible ambient temperature range during operation	-25°C ... +60°C (extended temperature range)
Permissible ambient temperature range during storage	-40°C ... +85°C
Permissible relative humidity	95%, no condensation
Dimensions (W x H x D)	approx. 15 mm x 100 mm x 70 mm (width aligned: 12 mm)
Mounting [▶ 155]	on 35 mm mounting rail conforms to EN 60715
Enhanced mechanical load capacity	yes, see also Installation instructions for enhanced mechanical load capacity [▶ 158]
Vibration/shock resistance	conforms to EN 60068-2-6 / EN 60068-2-27
EMC immunity/emission	conforms to EN 61000-6-2 / EN 61000-6-4
Protection class	IP20
Installation position	variable
Marking / Approval ^{*)}	CE, EAC, UKCA ATEX [▶ 149], IECEx [▶ 150], cULus [▶ 154]

*) Real applicable approvals/markings see type plate on the side (product marking).

Ex markings

Standard	Marking
ATEX	II 3 G Ex nA IIC T4 Gc
IECEx	Ex nA IIC T4 Gc

2.2.4.3 EL3114 - Connection, display and diagnostics

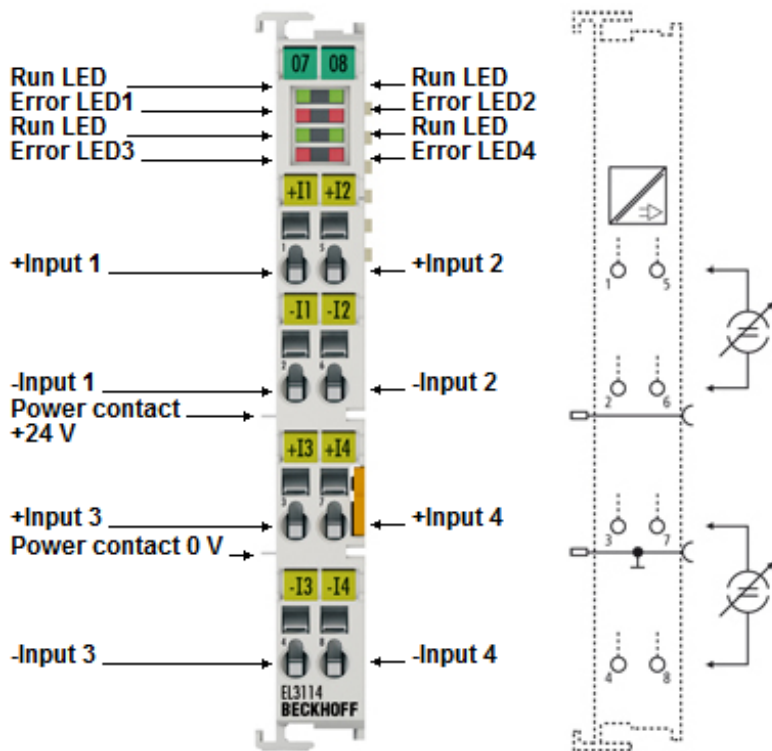

Fig. 17: EL3114 - LEDs and connection

Connection EL3114				
Terminal point		Description	Internally connected with connection	Max. current carrying capacity *)
Name	No.			
+ Input 1	1	+ Input 1	-	40 mA
- Input 1	2	- Input 1	-	40 mA
+ Input 3	3	+ Input 3	-	40 mA
- Input 3	4	- Input 3	-	40 mA
+ Input 2	5	+ Input 2	-	40 mA
- Input 2	6	- Input 2	-	40 mA
+ Input 4	7	+ Input 4	-	40 mA
- Input 4	8	- Input 4	-	40 mA

*) Constant and peak value

● GND connection points

i The GND connection points of the terminal are not connected internally directly, but via EMC protection components. Therefore, each analog encoder/sensor must be connected separately with 2 wires, even if the connection diagram of the terminal for the channels indicates a common ground (GND).

● Current carrying capacity of the input contacts

i The maximum permitted current on the signal-relevant terminal points (inputs, GND) is 40 mA (if applicable).

i Overcurrent protection of the 20 mA inputs

The current inputs are protected against damage by overcurrent by an internal current limitation, currents > 30mA may occur. In the event of a fault, the current limiter must not be overloaded by a voltage > 30V from the source device.

Overcurrent is displayed in the process image as "Overrange". After occurrence, the error condition must be stopped immediately, the source device switched off or disconnected from the input terminal. If the error condition persists for a longer period of time, the internal terminal current limitation reduces the absorbed signal current for thermal reasons, depending on the ambient conditions also below 20 mA.

LEDs			
LED	Color	Meaning	
RUN*	green	This LED indicates the terminal's operating state *:	
		off	State of the EtherCAT State Machine [▶ 139]: INIT = initialization of the terminal or BOOTSTRAP = function for <u>firmware updates</u> [▶ 491] of the terminal
		flashing	State of the EtherCAT State Machine: PREOP = function for mailbox communication and different standard-settings set
		single flash	State of the EtherCAT State Machine: SAFEOP = verification of the <u>Sync Manager</u> [▶ 219] channels and the distributed clocks. Outputs remain in safe state
		on	State of the EtherCAT State Machine: OP = normal operating state; mailbox and process data communication is possible
ERROR**	red	Fault indication in the event of undershooting or overshooting of the measuring range	
*) If several RUN LEDs are present, all of them have the same function			
**) The error display shows the signal processing state for each channel			

2.3 EL312x

2.3.1 EL3121

2.3.1.1 EL3121 - Introduction

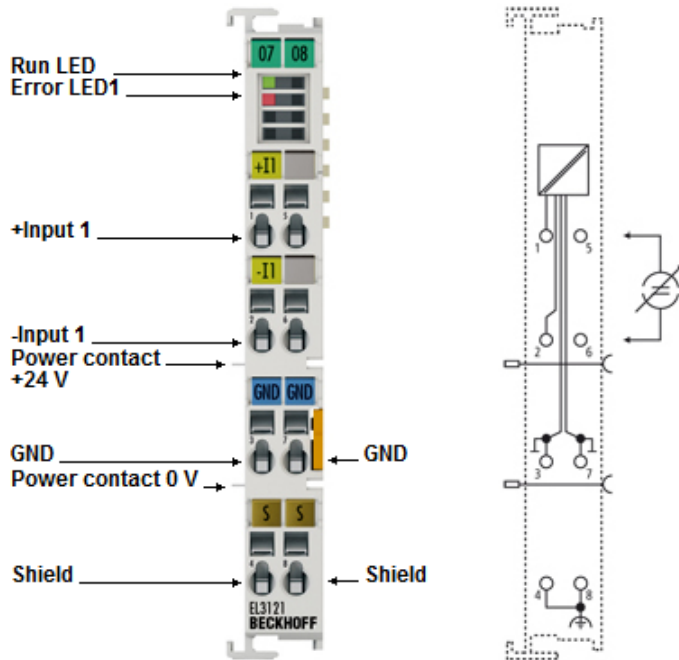

Fig. 18: EL3121

Analog Input Terminal; 1 channel, current, 4...20 mA, 16 bit, differential

The EL3121 analog input terminal processes signals in the range between 4 and 20 mA. The current is digitized to a resolution of 16 bits and is transmitted, electrically isolated, to the higher-level automation device.

The input channels of the EtherCAT Terminal have differential inputs and possess a common, internal ground potential. The EL3121 is the single-channel version and is characterized by its fine granularity and electrical isolation. An open lead or overload condition are detected. The terminal status is relayed to the controller via the E-bus.

The EtherCAT Terminal indicates its signal state by means of light emitting diodes. The error LEDs indicate an overload condition and a broken wire..

Quick-Links

- [EtherCAT basics](#)
- [Process data and operating modes \[► 244\]](#)
- [Object description and parameterization \[► 334\]](#)

2.3.1.2 EL3121 - Technical data

Technical data	EL3121
Analog inputs	1
Signal current	4 mA...20 mA
Internal resistance	85 Ω type. + diode voltage
Resolution	16 bit (including sign)
Sampling type	simultaneous
Ground reference	differential
Conversion time (without filter)	approx. 40 μs
Input filter limit frequency	5 kHz
Measuring error (full measuring range)	< ± 0.3% (at 0 °C ... +55 °C, relative to the full scale value) < ± 0.5% (when the extended temperature range is used)
Supply voltage for electronic	via the E-bus
Current consumption via E-bus	typ. 130 mA
Distributed Clocks	yes
Distributed Clocks precision	<< 1 μs
Support NoCoEStorage [▶ 142]	yes
Electrical isolation	500 V (E-bus/field voltage)
Common mode voltage U_{cm}	max. 10 V
Bit width of the process image (default setting)	Inputs: 1 x 16 bit; Status: 1 x 8 bit
Configuration	no address or configuration settings required
Weight	approx. 55 g
Permissible ambient temperature range during operation	-25°C ... +60°C (extended temperature range)
Permissible ambient temperature range during storage	-40°C ... +85°C
Permissible relative humidity	95%, no condensation
Dimensions (W x H x D)	approx. 15 mm x 100 mm x 70 mm (width aligned: 12 mm)
Mounting [▶ 155]	on 35 mm mounting rail conforms to EN 60715
Enhanced mechanical load capacity	yes, see also Installation instructions for enhanced mechanical load capacity [▶ 158]
Vibration/shock resistance	conforms to EN 60068-2-6 / EN 60068-2-27
EMC immunity/emission	conforms to EN 61000-6-2 / EN 61000-6-4
Protection class	IP20
Installation position	variable
Marking / Approval ^{*)}	CE, EAC, UKCA, ATEX [▶ 149], IECEX [▶ 150], cULus [▶ 154]

*) Real applicable approvals/markings see type plate on the side (product marking).

Ex markings

Standard	Marking
ATEX	II 3 G Ex nA IIC T4 Gc
IECEX	Ex nA IIC T4 Gc

2.3.1.3 EL3121 - Connection, display and diagnostics

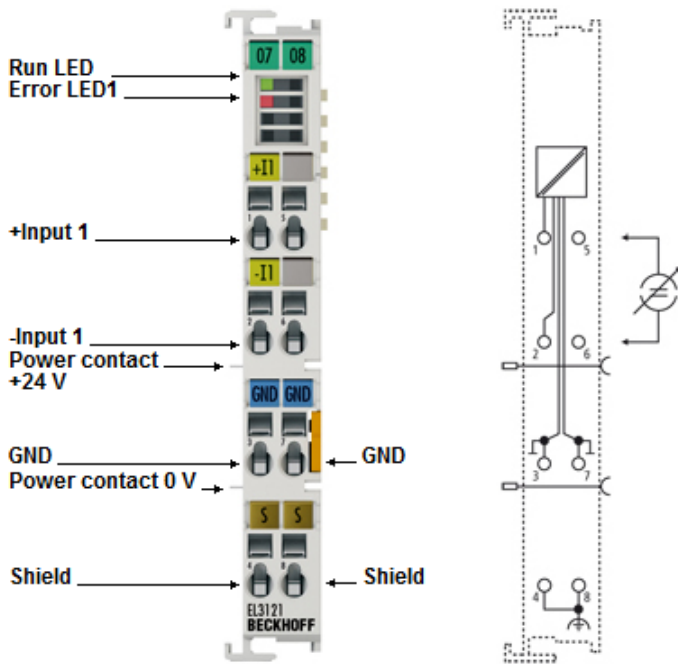

Fig. 19: EL3121 - LEDs and connection

Connection EL3121				
Terminal point		Description	Internally connected with connection	Max. current carrying capacity *)
Name	No.			
+ Input 1	1	+ Input 1	-	40 mA
- Input 1	2	- Input 1	-	40 mA
GND	3	Signal ground for input 1	7, (high impedance, therefore potential equal but not current loadable)	40 mA
Shield	4	Shield (FE)	8; DIN rail	100 mA **)
n. c.	5	not connected	-	-
n. c.	6	not connected	-	-
GND	7	Signal ground for input 1	3, (high impedance, therefore potential equal but not current loadable)	40 mA
Shield	8	Shield (FE)	4; DIN rail	100 mA **)

*) Constant and peak value

***) Shield lines should be de-energized!

● GND connection points

i The GND connection points of the terminal are not connected internally directly, but via EMC protection components. Therefore, each analog encoder/sensor must be connected separately with 2 wires, even if the connection diagram of the terminal for the channels indicates a common ground (GND).

● Current carrying capacity of the input contacts

i The maximum permitted current on the signal-relevant terminal points (inputs, GND) is 40 mA (if applicable).

NOTICE

Terminal GND and system GND

The signal ground GND of this terminal is not internally connected to the negative power contact. This design allows GND to be connected to a ground other than the negative power contact "Power contact 0V" if necessary.

If disturbing potential differences occur, GND must be electrically connected to the system GND or another suitable ground.

● Overcurrent protection of the 20 mA inputs

i The current inputs are protected against damage by overcurrent by an internal current limitation, currents > 30mA may occur. In the event of a fault, the current limiter must not be overloaded by a voltage > 30V from the source device.

Overcurrent is displayed in the process image as "Overrange". After occurrence, the error condition must be stopped immediately, the source device switched off or disconnected from the input terminal. If the error condition persists for a longer period of time, the internal terminal current limitation reduces the absorbed signal current for thermal reasons, depending on the ambient conditions also below 20 mA.

LEDs			
LED	Color	Meaning	
RUN*	green	This LED indicates the terminal's operating state *:	
		off	State of the EtherCAT State Machine [▶ 139] : INIT = initialization of the terminal or BOOTSTRAP = function for firmware updates [▶ 491] of the terminal
		flashing	State of the EtherCAT State Machine: PREOP = function for mailbox communication and different standard-settings set
		single flash	State of the EtherCAT State Machine: SAFEOP = verification of the Sync Manager [▶ 219] channels and the distributed clocks. Outputs remain in safe state
		on	State of the EtherCAT State Machine: OP = normal operating state; mailbox and process data communication is possible
ERROR**	red	Fault indication in the event of undershooting or overshooting of the measuring range	
*) If several RUN LEDs are present, all of them have the same function			
**) The error display shows the signal processing state for each channel			

2.3.2 EL3122

2.3.2.1 EL3122 - Introduction

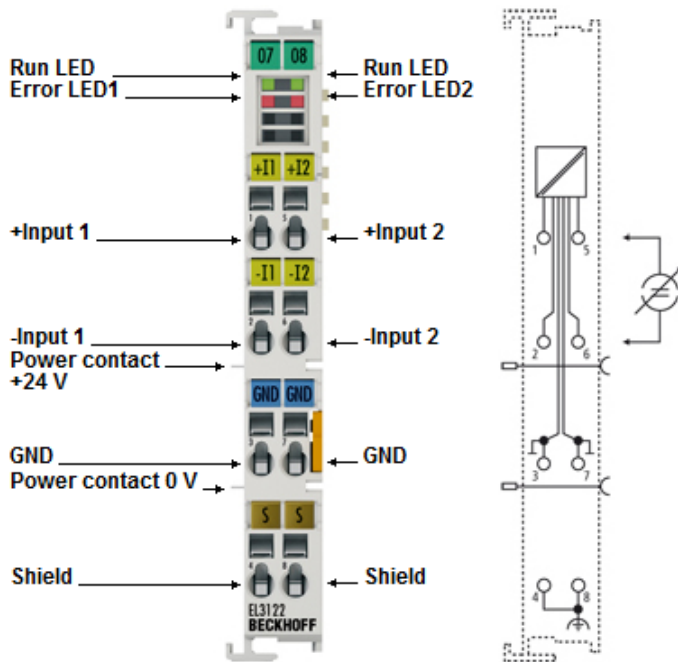

Fig. 20: EL3122

Analog Input Terminal; 2 channel, current, 4...20 mA, 16 bit, differential

The EL3122 analog input terminal processes signals in the range between 4 and 20 mA. The current is digitized to a resolution of 16 bits and is transmitted, electrically isolated, to the higher-level automation device.

The input channels of the EtherCAT Terminal have differential inputs and possess a common, internal ground potential. The EL3122 combines two channels in one housing. An open lead or overload condition are detected.

The terminal status is relayed to the controller via the E-bus. The EtherCAT Terminal indicates its signal state by means of light emitting diodes. The error LEDs indicate an overload condition and a broken wire.

Quick-Links

- [EtherCAT basics](#)
- [Process data and operating modes \[► 244\]](#)
- [Object description and parameterization \[► 341\]](#)

2.3.2.2 EL3122 - Technical data

Technical data	EL3122
Analog inputs	2
Signal current	4 mA...20 mA
Internal resistance	85 Ω type. + diode voltage
Resolution	16 bit (including sign)
Sampling type	simultaneous
Ground reference	differential
Conversion time (without filter)	approx. 50 μs (Fast mode: approx. 35 μs)
Input filter limit frequency	5 kHz
Measuring error (full measuring range)	< ± 0.3% (at 0 °C ... +55 °C, relative to the full scale value) < ± 0.5% (when the extended temperature range is used)
Supply voltage for electronic	via the E-bus
Current consumption via E-bus	typ. 170 mA
Distributed Clocks	yes (from rev. EL312x-0000-0017 [▶ 484])
Distributed Clocks precision	<< 1 μs
Support NoCoEStorage [▶ 142]	yes
Electrical isolation	500 V (E-bus/field voltage)
Common mode voltage U_{cm}	max. 10 V
Bit width of the process image (default setting)	Inputs: 2 x 16 bit; Status: 2 x 8 bit
Configuration	no address or configuration settings required
Weight	approx. 55 g
Permissible ambient temperature range during operation	-25°C ... +60°C (extended temperature range)
Permissible ambient temperature range during storage	-40°C ... +85°C
Permissible relative humidity	95%, no condensation
Dimensions (W x H x D)	approx. 15 mm x 100 mm x 70 mm (width aligned: 12 mm)
Mounting [▶ 155]	on 35 mm mounting rail conforms to EN 60715
Enhanced mechanical load capacity	yes, see also Installation instructions for enhanced mechanical load capacity [▶ 158]
Vibration/shock resistance	conforms to EN 60068-2-6 / EN 60068-2-27
EMC immunity/emission	conforms to EN 61000-6-2 / EN 61000-6-4
Protection class	IP20
Installation position	variable
Marking / Approval ^{*)}	CE, EAC, UKCA, ATEX [▶ 149] , IECEx [▶ 150] , cULus [▶ 154]

*) Real applicable approvals/markings see type plate on the side (product marking).

Ex markings

Standard	Marking
ATEX	II 3 G Ex nA IIC T4 Gc
IECEx	Ex nA IIC T4 Gc

2.3.2.3 EL3122 - Connection, display and diagnostics

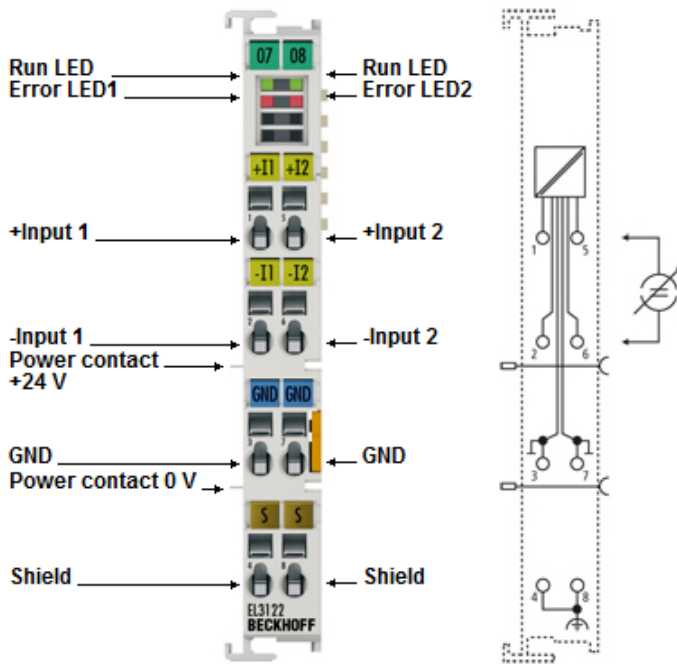

Fig. 21: EL3122 - LEDs and connection

Connection EL3122				
Terminal point		Description	Internally connected with connection	Max. current carrying capacity *)
Name	No.			
+ Input 1	1	+ Input 1	-	40 mA
- Input 1	2	- Input 1	-	40 mA
GND	3	Signal ground for input 1	7, (high impedance, therefore potential equal but not current loadable)	40 mA
Shield	4	Shield (FE)	8; DIN rail	100 mA **)
+ Input 2	5	+ Input 2	-	40 mA
- Input 2	6	- Input 2	-	40 mA
GND	7	Signal ground for input 2	3, (high impedance, therefore potential equal but not current loadable)	40 mA
Shield	8	Shield (FE)	4; DIN rail	100 mA **)

*) Constant and peak value

***) Shield lines should be de-energized!

● GND connection points

i The GND connection points of the terminal are not connected internally directly, but via EMC protection components. Therefore, each analog encoder/sensor must be connected separately with 2 wires, even if the connection diagram of the terminal for the channels indicates a common ground (GND).

● Current carrying capacity of the input contacts

i The maximum permitted current on the signal-relevant terminal points (inputs, GND) is 40 mA (if applicable).

NOTICE

Terminal GND and system GND

The signal ground GND of this terminal is not internally connected to the negative power contact. This design allows GND to be connected to a ground other than the negative power contact "Power contact 0V" if necessary.

If disturbing potential differences occur, GND must be electrically connected to the system GND or another suitable ground.

● Overcurrent protection of the 20 mA inputs

i The current inputs are protected against damage by overcurrent by an internal current limitation, currents > 30mA may occur. In the event of a fault, the current limiter must not be overloaded by a voltage > 30V from the source device.

Overcurrent is displayed in the process image as "Overrange". After occurrence, the error condition must be stopped immediately, the source device switched off or disconnected from the input terminal. If the error condition persists for a longer period of time, the internal terminal current limitation reduces the absorbed signal current for thermal reasons, depending on the ambient conditions also below 20 mA.

LEDs			
LED	Color	Meaning	
RUN*	green	This LED indicates the terminal's operating state *:	
		off	State of the EtherCAT State Machine [▶ 139] : INIT = initialization of the terminal or BOOTSTRAP = function for firmware updates [▶ 491] of the terminal
		flashing	State of the EtherCAT State Machine: PREOP = function for mailbox communication and different standard-settings set
		single flash	State of the EtherCAT State Machine: SAFEOP = verification of the Sync Manager [▶ 219] channels and the distributed clocks. Outputs remain in safe state
on	State of the EtherCAT State Machine: OP = normal operating state; mailbox and process data communication is possible		
ERROR**	red	Fault indication in the event of undershooting or overshooting of the measuring range	
*) If several RUN LEDs are present, all of them have the same function			
**) The error display shows the signal processing state for each channel			

2.3.3 EL3124

2.3.3.1 EL3124 - Introduction

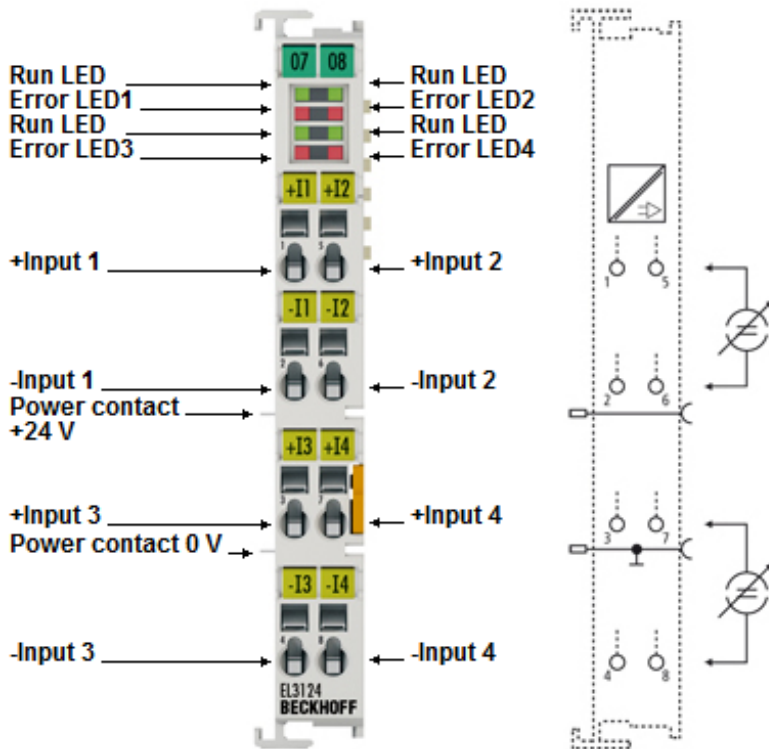

Fig. 22: EL3124

Analog Input Terminal; 4 channel, current, 4...20 mA, 16 bit, differential

The EL3124 analog input terminal handles signals in the range from 4 to 20 mA. The current is digitized to a resolution of 16 bits and is transmitted, in an electrically isolated form, to the higher-level automation device.

The input channels of the EtherCAT Terminal have differential inputs and possess a common, internal ground potential. The EL3124 combines four channels in one housing. An open lead or overload condition are detected and the terminal status is relayed to the controller via the E-bus.

The EtherCAT Terminal indicates its signal state by means of light emitting diodes. The error LEDs indicate an overload condition and a broken wire.

Quick-Links

- [EtherCAT basics](#)
- [Process data and operation modes \[▶ 244\]](#)
- [Object description and parameterization \[▶ 353\]](#)

2.3.3.2 EL3124 - Technical data

Technical data	EL3124
Analog inputs	4
Signal current	4 mA...20 mA
Internal resistance	85 Ω type. + diode voltage
Resolution	16 bit (including sign)
Sampling type	multiplex
Ground reference	differential
Conversion time (without filter)	approx. 100 μs
Input filter limit frequency	5 kHz
Measuring error (full measuring range)	< ± 0.3% (at 0 °C ... +55 °C, relative to the full scale value) < ± 0.5% (when the extended temperature range is used)
Supply voltage for electronic	via the E-bus
Current consumption via E-bus	typ. 130 mA
Distributed Clocks	yes
Distributed Clocks precision	<< 1 μs
Support NoCoEStorage [▶ 142]	yes
Electrical isolation	500 V (E-bus/field voltage)
Common mode voltage U _{cm}	max. 10 V
Bit width of the process image (default setting)	Inputs: 4 x 16 bit; Status: 4 x 8 bit
Configuration	no address or configuration settings required
Weight	approx. 60 g
Permissible ambient temperature range during operation	-25°C ... +60°C (extended temperature range)
Permissible ambient temperature range during storage	-40°C ... +85°C
Permissible relative humidity	95%, no condensation
Dimensions (W x H x D)	approx. 15 mm x 100 mm x 70 mm (width aligned: 12 mm)
Mounting [▶ 155]	on 35 mm mounting rail conforms to EN 60715
Enhanced mechanical load capacity	yes, see also Installation instructions for enhanced mechanical load capacity [▶ 158]
Vibration/shock resistance	conforms to EN 60068-2-6 / EN 60068-2-27
EMC immunity/emission	conforms to EN 61000-6-2 / EN 61000-6-4
Protection class	IP20
Installation position	variable
Marking / Approval ^{*)}	CE, EAC, UKCA, ATEX [▶ 149], IECEX [▶ 150], cFMus [▶ 152], cULus [▶ 154]

*) Real applicable approvals/markings see type plate on the side (product marking).

Ex markings

Standard	Marking
ATEX	II 3 G Ex nA IIC T4 Gc II 3 D Ex tc IIIC T135 °C Dc
IECEX	Ex nA IIC T4 Gc Ex tc IIIC T135 °C Dc
cFMus	Class I, Division 2, Groups A, B, C, D Class I, Zone 2, AEx/Ex ec IIC T4 Gc

2.3.3.3 EL3124 - Connection, display and diagnostics

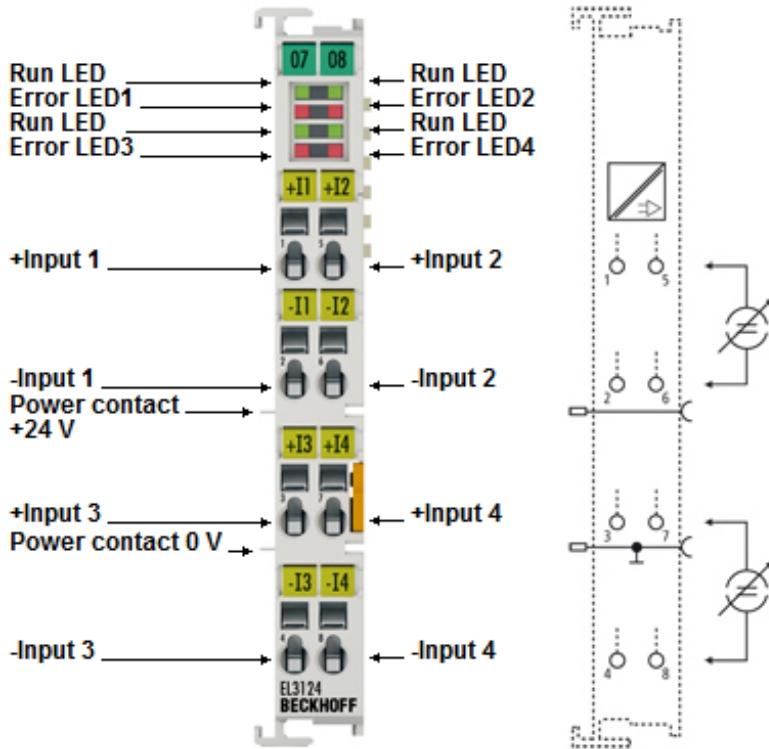

Fig. 23: EL3124 - LEDs and connection

Connection EL3124				
Terminal point		Description	Internally connected with connection	Max. current carrying capacity *)
Name	No.			
+ Input 1	1	+ Input 1	-	40 mA
- Input 1	2	- Input 1	-	40 mA
+ Input 3	3	+ Input 3	-	40 mA
- Input 3	4	- Input 3	-	40 mA
+ Input 2	5	+ Input 2	-	40 mA
- Input 2	6	- Input 2	-	40 mA
+ Input 4	7	+ Input 4	-	40 mA
- Input 4	8	- Input 4	-	40 mA

*) Constant and peak value

● GND connection points

i The GND connection points of the terminal are not connected internally directly, but via EMC protection components. Therefore, each analog encoder/sensor must be connected separately with 2 wires, even if the connection diagram of the terminal for the channels indicates a common ground (GND).

● Current carrying capacity of the input contacts

i The maximum permitted current on the signal-relevant terminal points (inputs, GND) is 40 mA (if applicable).

i Overcurrent protection of the 20 mA inputs

The current inputs are protected against damage by overcurrent by an internal current limitation, currents > 30mA may occur. In the event of a fault, the current limiter must not be overloaded by a voltage > 30V from the source device.

Overcurrent is displayed in the process image as "Overrange". After occurrence, the error condition must be stopped immediately, the source device switched off or disconnected from the input terminal. If the error condition persists for a longer period of time, the internal terminal current limitation reduces the absorbed signal current for thermal reasons, depending on the ambient conditions also below 20 mA.

LEDs			
LED	Color	Meaning	
RUN*	green	This LED indicates the terminal's operating state *:	
		off	State of the <u>EtherCAT State Machine</u> [▶ 139]: INIT = initialization of the terminal or BOOTSTRAP = function for <u>firmware updates</u> [▶ 491] of the terminal
		flashing	State of the EtherCAT State Machine: PREOP = function for mailbox communication and different standard-settings set
		single flash	State of the EtherCAT State Machine: SAFEOP = verification of the <u>Sync Manager</u> [▶ 219] channels and the distributed clocks. Outputs remain in safe state
		on	State of the EtherCAT State Machine: OP = normal operating state; mailbox and process data communication is possible
ERROR**	red	Fault indication in the event of undershooting or overshooting of the measuring range	
*) If several RUN LEDs are present, all of them have the same function			
**) The error display shows the signal processing state for each channel			

2.3.4 EL3124-0090

2.3.4.1 EL3124-0090 - Introduction

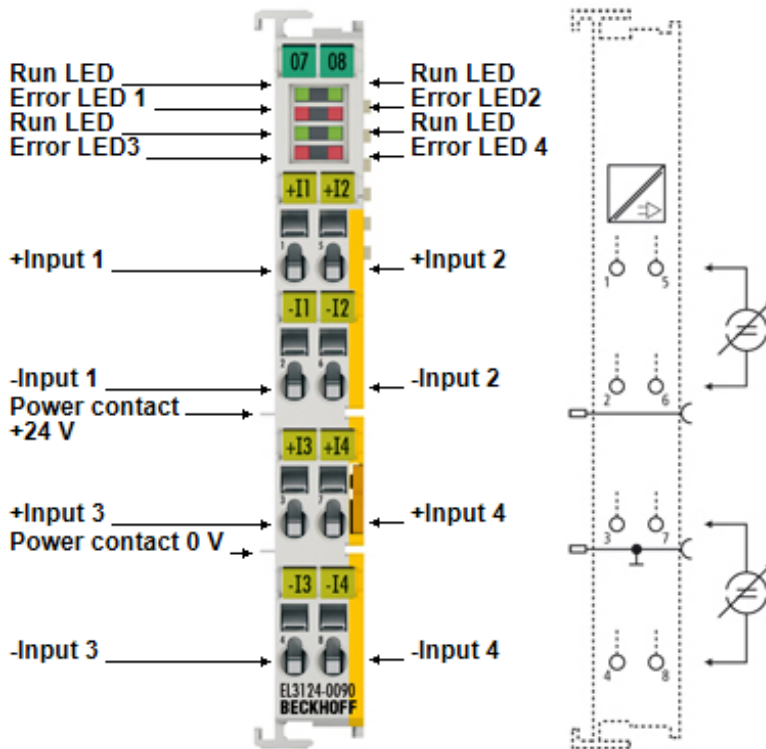

Fig. 24: EL3124-0090

Analog Input Terminal; 4 channel, current, 4...20 mA, 16 bit, differential, TwinSAFE SC

The EL3124-0090 analog input terminal handles signals in the range from 4 to 20 mA. The current is digitized to a resolution of 16 bits and is transmitted, in an electrically isolated form, to the higher-level automation device. The input channels of the EtherCAT Terminal have differential inputs and possess a common, internal ground potential.

With the aid of the TwinSAFE SC technology (TwinSAFE Single Channel) it is possible to make use of standard signals for safety tasks in any network or fieldbus. To do this, EtherCAT I/Os from the areas of analog input, position measurement or communication (4...20 mA, incremental encoder, IO-Link, etc.) are extended by the TwinSAFE SC function. The properties typical for the signals and the standard functions of the I/O components are retained. TwinSAFE SC I/Os differ optically from standard I/Os by a yellow stripe on the front of the housing.

The TwinSAFE SC technology enables communication via a TwinSAFE protocol. These connections can be distinguished from the usual secure communication via Safety over EtherCAT.

The data from the TwinSAFE SC components is fed via a TwinSAFE protocol to the TwinSAFE Logic, where it can be used in the context of safety-relevant applications. Detailed examples confirmed/calculated by the TÜV SÜD for the correct application of the TwinSAFE SC components and the respective normative classifications can be found in the TwinSAFE application manual..

Quick-Links

- [EtherCAT basics](#)
- [Process data and operation modes \[► 244\]](#)
- [Object description and parameterization \[► 362\]](#)

2.3.4.2 EL3124-0090 - Technical data

Technical data	EL3124-0090
Analog inputs	4
Signal current	4 mA...20 mA
Internal resistance	85 Ω type. + diode voltage
Resolution	16 bit (including sign)
Sampling type	multiplex
Ground reference	differential
Conversion time (without filter)	approx. 100 μs
Input filter limit frequency	5 kHz
Measuring error (full measuring range)	< ± 0.3% (at 0 °C ... +55 °C, relative to the full scale value) < ± 0.5% (when the extended temperature range is used)
MTBF (+55°C)	> 950.000 h
Supply voltage for electronic	via the E-bus
Current consumption via E-bus	typ. 130 mA
Distributed Clocks	yes
Distributed Clocks precision	<< 1 μs
Support NoCoEStorage [▶ 142]	yes
Electrical isolation	500 V (E-bus/field voltage)
Common mode voltage U _{cm}	max. 10 V
Bit width of the process image (default setting)	Inputs: 4 x 16 bit; Status: 4 x 8 bit
Configuration	no address or configuration settings required
Weight	approx. 60 g
Permissible ambient temperature range during operation	-25°C ... +60°C (extended temperature range)
Permissible ambient temperature range during storage	-40°C ... +85°C
Permissible relative humidity	95%, no condensation
Dimensions (W x H x D)	approx. 15 mm x 100 mm x 70 mm (width aligned: 12 mm)
Mounting [▶ 155]	on 35 mm mounting rail conforms to EN 60715
Enhanced mechanical load capacity	yes, see also Installation instructions for enhanced mechanical load capacity [▶ 158]
Vibration/shock resistance	conforms to EN 60068-2-6 / EN 60068-2-27
EMC immunity/emission	conforms to EN 61000-6-2 / EN 61000-6-4
Protection class	IP20
Installation position	variable
Marking / Approval ^{*)}	CE, EAC, UKCA ATEX [▶ 149], IECEx [▶ 150], cULus [▶ 154]

*) Real applicable approvals/markings see type plate on the side (product marking).

Ex markings

Standard	Marking
ATEX	II 3 G Ex nA IIC T4 Gc
IECEx	Ex nA IIC T4 Gc

2.3.4.3 EL3124-0090 - Connection, display and diagnostics

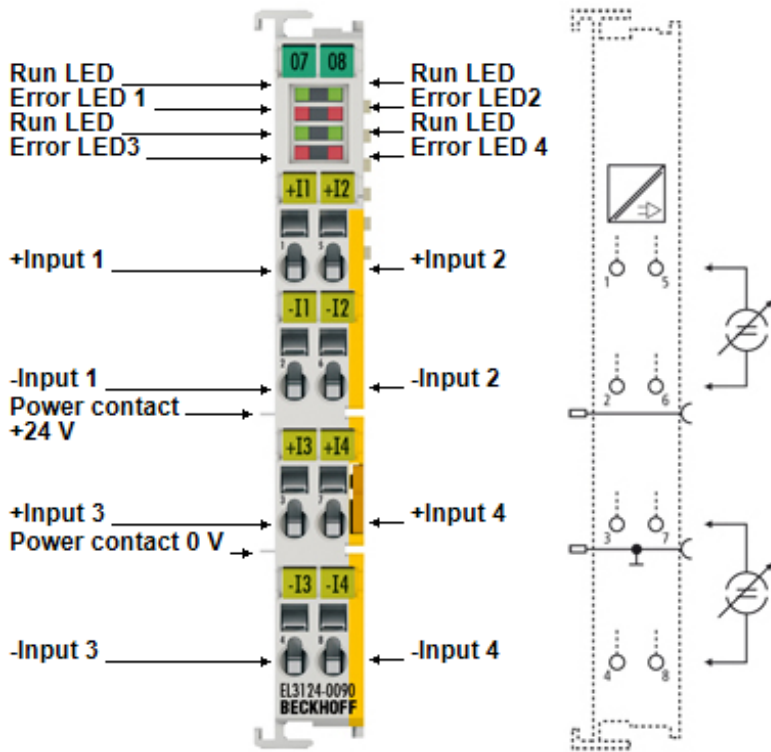

Fig. 25: EL3124-0090 - LEDs and connection

Connection EL3124-0090				
Terminal point		Description	Internally connected with connection	Max. current carrying capacity *)
Name	No.			
+ Input 1	1	+ Input 1	-	40 mA
- Input 1	2	- Input 1	-	40 mA
+ Input 3	3	+ Input 3	-	40 mA
- Input 3	4	- Input 3	-	40 mA
+ Input 2	5	+ Input 2	-	40 mA
- Input 2	6	- Input 2	-	40 mA
+ Input 4	7	+ Input 4	-	40 mA
- Input 4	8	- Input 4	-	40 mA

*) Constant and peak value

● GND connection points

i The GND connection points of the terminal are not connected internally directly, but via EMC protection components. Therefore, each analog encoder/sensor must be connected separately with 2 wires, even if the connection diagram of the terminal for the channels indicates a common ground (GND).

● Current carrying capacity of the input contacts

i The maximum permitted current on the signal-relevant terminal points (inputs, GND) is 40 mA (if applicable).

i Overcurrent protection of the 20 mA inputs

The current inputs are protected against damage by overcurrent by an internal current limitation, currents > 30mA may occur. In the event of a fault, the current limiter must not be overloaded by a voltage > 30V from the source device.

Overcurrent is displayed in the process image as "Overrange". After occurrence, the error condition must be stopped immediately, the source device switched off or disconnected from the input terminal. If the error condition persists for a longer period of time, the internal terminal current limitation reduces the absorbed signal current for thermal reasons, depending on the ambient conditions also below 20 mA.

LEDs			
LED	Color	Meaning	
RUN*	green	This LED indicates the terminal's operating state *:	
		off	State of the EtherCAT State Machine [▶ 139]: INIT = initialization of the terminal or BOOTSTRAP = function for <u>firmware updates</u> [▶ 491] of the terminal
		flashing	State of the EtherCAT State Machine: PREOP = function for mailbox communication and different standard-settings set
		single flash	State of the EtherCAT State Machine: SAFEOP = verification of the <u>Sync Manager</u> [▶ 219] channels and the distributed clocks. Outputs remain in safe state
		on	State of the EtherCAT State Machine: OP = normal operating state; mailbox and process data communication is possible
ERROR**	red	Fault indication in the event of undershooting or overshooting of the measuring range	
*) If several RUN LEDs are present, all of them have the same function			
**) The error display shows the signal processing state for each channel			

2.4 EL314x

2.4.1 EL3141

2.4.1.1 EL3141 - Introduction

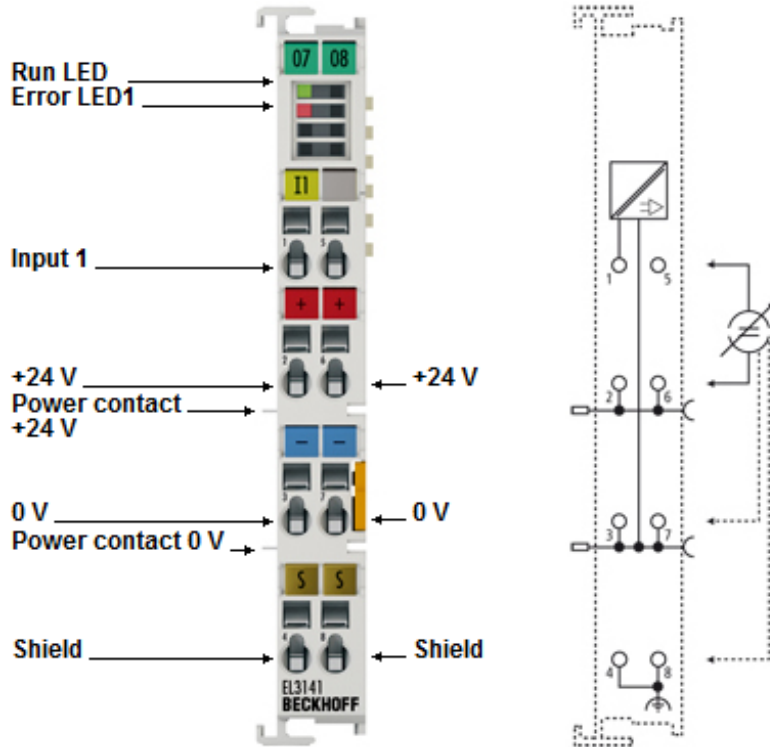

Fig. 26: EL3141

Analog Input Terminal; 1 channel, current, 0...20 mA, 16 bit, single-ended

The job of the EL3141 analog input terminal is to supply power to measuring transducers located in the field, and to transmit analog measurement signals with electrical isolation to the automation device.

The voltage for the sensors is supplied to the terminals via the power contacts. The power contacts can optionally be supplied with operating voltage in the standard way or via a supply terminal (EL9xxx) with electrical isolation.

The input electronics is independent of the supply voltage of the power contacts. The 0 V power contact is the reference potential for the inputs. The EtherCAT Terminal indicates its signal state by means of light emitting diodes..

Quick-Links

- [EtherCAT basics](#)
- [Process data and operating modes \[► 244\]](#)
- [Object description and parameterization \[► 373\]](#)

2.4.1.2 EL3141 - Technical data

Technical data	EL3141
Analog inputs	1
Signal current	0 mA...20 mA
Internal resistance	85 Ω type. + diode voltage
Resolution	16 bit (including sign)
Sampling type	simultaneous
Ground reference	single-ended
Conversion time (default setting: 50 Hz filter)	approx. 40 μs
Input filter limit frequency	5 kHz
Measuring error (full measuring range)	< ± 0.3% (at 0 °C ... +55 °C, relative to the full scale value) < ± 0.5% (when the extended temperature range is used)
Supply voltage for electronic	via the E-bus
Current consumption via E-bus	typ. 130 mA
Distributed Clocks	yes
Distributed Clocks precision	<< 1 μs
Support NoCoEStorage [▶ 142]	yes
Electrical isolation	500 V (E-bus/field voltage)
Dielectric strength	max. 30 V
Bit width of the process image (default setting)	Inputs: 1 x 16 bit; Status: 1 x 8 bit
Configuration	no address or configuration settings required
Weight	approx. 55 g
Permissible ambient temperature range during operation	-25°C ... +60°C (extended temperature range)
Permissible ambient temperature range during storage	-40°C ... +85°C
Permissible relative humidity	95%, no condensation
Dimensions (W x H x D)	approx. 15 mm x 100 mm x 70 mm (width aligned: 12 mm)
Mounting [▶ 155]	on 35 mm mounting rail conforms to EN 60715
Enhanced mechanical load capacity	yes, see also Installation instructions for enhanced mechanical load capacity [▶ 158]
Vibration/shock resistance	conforms to EN 60068-2-6 / EN 60068-2-27
EMC immunity/emission	conforms to EN 61000-6-2 / EN 61000-6-4
Protection class	IP20
Installation position	variable
Marking / Approval ^{*)}	CE, EAC, UKCA ATEX [▶ 149] , IECEX [▶ 150] , cULus [▶ 154]

*) Real applicable approvals/markings see type plate on the side (product marking).

Ex markings

Standard	Marking
ATEX	II 3 G Ex nA IIC T4 Gc
IECEX	Ex nA IIC T4 Gc

2.4.1.3 EL3141 - Connection, display and diagnostics

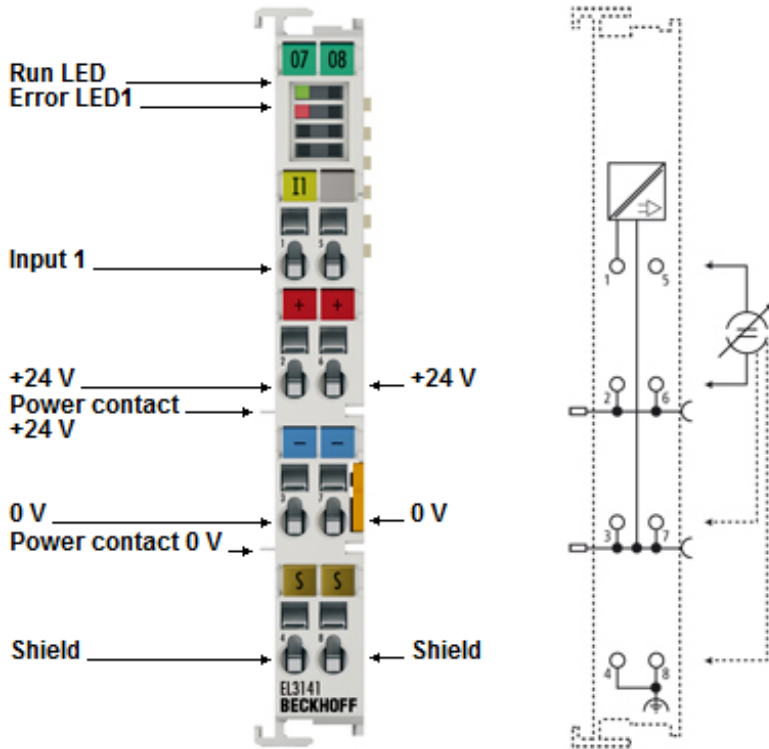

Fig. 27: EL3141 - LEDs and connection

Connection EL3141				
Terminal point		Description	Internally connected with connection	Max. current carrying capacity *)
Name	No.			
+ Input 1	1	+ Input 1	-	40 mA
+24 V	2	+24 V	6, positive power contact	1 A
0 V	3	0 V	7, negative power contact	1 A
Shield	4	Shield (FE)	8; DIN rail	100 mA **)
n. c.	5	not connected	-	-
+24 V	6	+24 V	2, positive power contact	1 A
0 V	7	0 V	3, negative power contact	1 A
Shield	8	Shield (FE)	4; DIN rail	100 mA **)

*) Constant and peak value

***) Shield lines should be de-energized!

● Overcurrent protection of the 20 mA inputs

i The current inputs are protected against damage by overcurrent by an internal current limitation, currents > 30mA may occur. In the event of a fault, the current limiter must not be overloaded by a voltage > 30V from the source device.

Overcurrent is displayed in the process image as "Overrange". After occurrence, the error condition must be stopped immediately, the source device switched off or disconnected from the input terminal. If the error condition persists for a longer period of time, the internal terminal current limitation reduces the absorbed signal current for thermal reasons, depending on the ambient conditions also below 20 mA.

LEDs			
LED	Color	Meaning	
RUN*	green	This LED indicates the terminal's operating state *:	
		off	State of the EtherCAT State Machine [▶ 139]: INIT = initialization of the terminal or BOOTSTRAP = function for <u>firmware updates</u> [▶ 491] of the terminal
		flashing	State of the EtherCAT State Machine: PREOP = function for mailbox communication and different standard-settings set
		single flash	State of the EtherCAT State Machine: SAFEOP = verification of the <u>Sync Manager</u> [▶ 219] channels and the distributed clocks. Outputs remain in safe state
		on	State of the EtherCAT State Machine: OP = normal operating state; mailbox and process data communication is possible
ERROR**	red	Fault indication in the event of undershooting or overshooting of the measuring range	
*) If several RUN LEDs are present, all of them have the same function			
**) The error display shows the signal processing state for each channel			

2.4.2 EL3142

2.4.2.1 EL3142 - Introduction

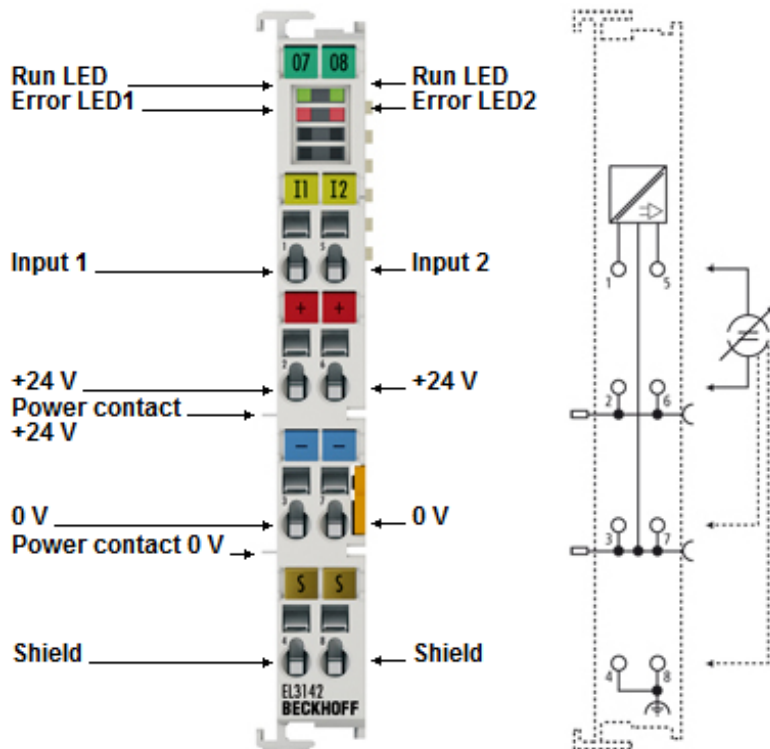

Fig. 28: EL3142

Analog Input Terminal; 2 channel, current, 0...20 mA, 16 bit, single-ended

The job of the EL3142 analog input terminal is to supply power to measuring transducers located in the field, and to transmit analog measurement signals with electrical isolation to the automation device.

The voltage for the sensors is supplied to the terminals via the power contacts. The power contacts can optionally be supplied with operating voltage in the standard way or via a supply terminal (EL9xxx) with electrical isolation.

The input electronics is independent of the supply voltage of the power contacts. The 0 V power contact is the reference potential for the inputs. The EtherCAT Terminal indicates its signal state by means of light emitting diodes.

Quick-Links

- [EtherCAT basics](#)
- [Process data and operating modes \[► 244\]](#)
- [Object description and parameterization \[► 380\]](#)

2.4.2.2 EL3142 - Technical data

Technical data	EL3142
Analog inputs	2
Signal current	0 mA...20 mA
Internal resistance	85 Ω type. + diode voltage
Resolution	16 bit (including sign)
Sampling type	simultaneous
Ground reference	single-ended
Conversion time (default setting: 50 Hz filter)	approx. 60 μs (Fast-Mode: ca. 40 μs)
Input filter limit frequency	5 kHz
Measuring error (full measuring range)	< ± 0.3% (at 0 °C ... +55 °C, relative to the full scale value) < ± 0.5% (when the extended temperature range is used)
Supply voltage for electronic	via the E-bus
Current consumption via E-bus	typ. 170 mA
Distributed Clocks	yes (from Rev. EL314x-0000-0017 [▶ 484])
Distributed Clocks precision	<< 1 μs
Support NoCoEStorage [▶ 142]	yes
Electrical isolation	500 V (E-bus/field voltage)
Dielectric strength	max. 30 V
Bit width of the process image (default setting)	Inputs: 2 x 16 bit; Status: 2 x 8 bit
Configuration	no address or configuration settings required
Weight	approx. 55 g
Permissible ambient temperature range during operation	-25°C ... +60°C (extended temperature range)
Permissible ambient temperature range during storage	-40°C ... +85°C
Permissible relative humidity	95%, no condensation
Dimensions (W x H x D)	approx. 15 mm x 100 mm x 70 mm (width aligned: 12 mm)
Mounting [▶ 155]	on 35 mm mounting rail conforms to EN 60715
Enhanced mechanical load capacity	yes, see also Installation instructions for enhanced mechanical load capacity [▶ 158]
Vibration/shock resistance	conforms to EN 60068-2-6 / EN 60068-2-27
EMC immunity/emission	conforms to EN 61000-6-2 / EN 61000-6-4
Protection class	IP20
Installation position	variable
Marking / Approval ^{*)}	CE, EAC, UKCA ATEX [▶ 149], IECEx [▶ 150], cULus [▶ 154]

*) Real applicable approvals/markings see type plate on the side (product marking).

Ex markings

Standard	Marking
ATEX	II 3 G Ex nA IIC T4 Gc
IECEX	Ex nA IIC T4 Gc

2.4.2.3 EL3142 - Connection, display and diagnostics

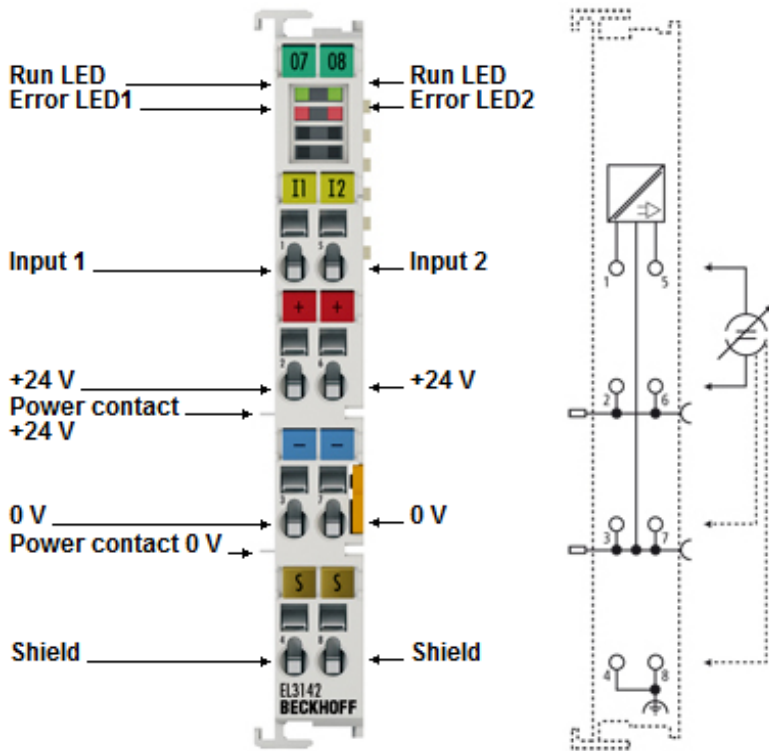

Fig. 29: EL3142 - LEDs and connection

Connection EL3142				
Terminal point		Description	Internally connected with connection	Max. current carrying capacity *)
Name	No.			
+ Input 1	1	+ Input 1	-	40 mA
+24 V	2	+24 V	6, positive power contact	1 A
0 V	3	0 V	7, negative power contact	1 A
Shield	4	Shield (FE)	8; DIN rail	100 mA **)
+ Input 2	5	+ Input 2	-	40 mA
+24 V	6	+24 V	2, positive power contact	1 A
0 V	7	0 V	3, negative power contact	1 A
Shield	8	Shield (FE)	4; DIN rail	100 mA **)

*) Constant and peak value

***) Shield lines should be de-energized!

● Overcurrent protection of the 20 mA inputs

I The current inputs are protected against damage by overcurrent by an internal current limitation, currents > 30mA may occur. In the event of a fault, the current limiter must not be overloaded by a voltage > 30V from the source device.

Overcurrent is displayed in the process image as "Overrange". After occurrence, the error condition must be stopped immediately, the source device switched off or disconnected from the input terminal. If the error condition persists for a longer period of time, the internal terminal current limitation reduces the absorbed signal current for thermal reasons, depending on the ambient conditions also below 20 mA.

LEDs			
LED	Color	Meaning	
RUN*	green	This LED indicates the terminal's operating state *:	
		off	State of the EtherCAT State Machine [▶ 139]: INIT = initialization of the terminal or BOOTSTRAP = function for <u>firmware updates</u> [▶ 491] of the terminal
		flashing	State of the EtherCAT State Machine: PREOP = function for mailbox communication and different standard-settings set
		single flash	State of the EtherCAT State Machine: SAFEOP = verification of the <u>Sync Manager</u> [▶ 219] channels and the distributed clocks. Outputs remain in safe state
on	State of the EtherCAT State Machine: OP = normal operating state; mailbox and process data communication is possible		
ERROR**	red	Fault indication in the event of undershooting or overshooting of the measuring range	
*) If several RUN LEDs are present, all of them have the same function			
**) The error display shows the signal processing state for each channel			

2.4.3 EL3142-0010

2.4.3.1 EL3142-0010 - Introduction

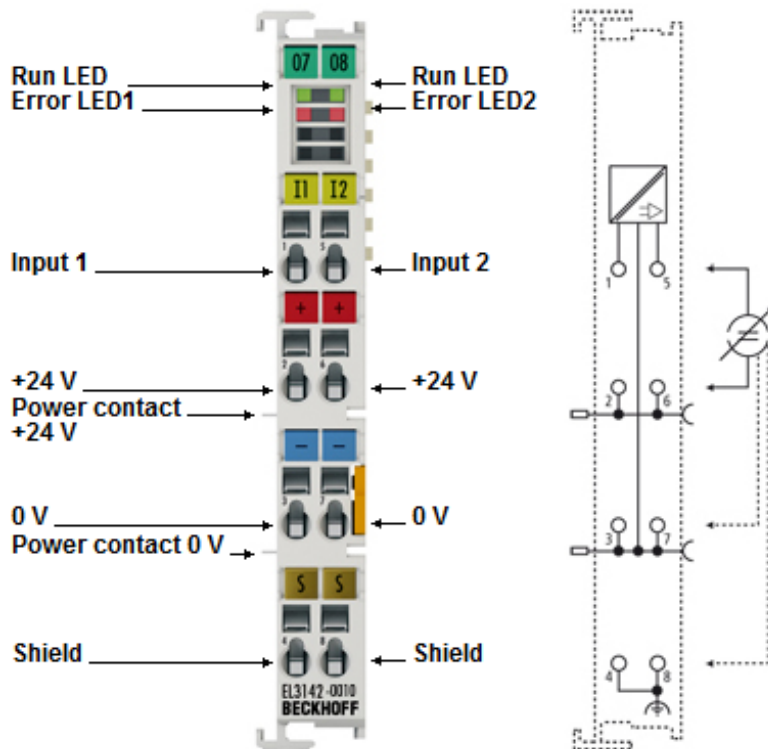

Fig. 30: EL3142-0010

Analog Input Terminal; 2 channel, current, ± 10 mA, 16 bit, single-ended

The job of the EL3142-0010 analog input terminal is to supply power to measuring transducers located in the field, and to transmit analog measurement signals with electrical isolation to the automation device.

The voltage for the sensors is supplied to the terminals via the power contacts. The power contacts can optionally be supplied with operating voltage in the standard way or via a supply terminal (EL9xxx) with electrical isolation.

The input electronics is independent of the supply voltage of the power contacts. The 0 V power contact is the reference potential for the inputs. The EtherCAT Terminal indicates its signal state by means of light emitting diodes.

Quick-Links

- [EtherCAT basics](#)
- [Process data and operating modes \[► 244\]](#)
- [Object description and parameterization \[► 380\]](#)

2.4.3.2 EL3142-0010 - Technical data

Technical data	EL3142-0010
Analog inputs	2
Signal current	-10 mA...+10 mA
Internal resistance	85 Ω type. + diode voltage
Resolution	16 bit (including sign)
Sampling type	simultaneous
Ground reference	single-ended
Conversion time (default setting: 50 Hz filter)	approx. 60 μs (Fast-Mode: ca. 40 μs)
Input filter limit frequency	5 kHz
Measuring error (full measuring range)	< ± 0.3% (at 0 °C ... +55 °C, relative to the full scale value) < ± 0.5% (when the extended temperature range is used)
Supply voltage for electronic	via the E-bus
Current consumption via E-bus	typ. 170 mA
Distributed Clocks	yes (from Rev. EL314x-0000-0017 [▶ 484])
Distributed Clocks precision	<< 1 μs
Support NoCoEStorage [▶ 142]	yes
Electrical isolation	500 V (E-bus/field voltage)
Dielectric strength	max. 30 V
Bit width of the process image (default setting)	Inputs: 2 x 16 bit; Status: 2 x 8 bit
Configuration	no address or configuration settings required
Weight	approx. 55 g
Permissible ambient temperature range during operation	-25°C ... +60°C (extended temperature range)
Permissible ambient temperature range during storage	-40°C ... +85°C
Permissible relative humidity	95%, no condensation
Dimensions (W x H x D)	approx. 15 mm x 100 mm x 70 mm (width aligned: 12 mm)
Mounting [▶ 155]	on 35 mm mounting rail conforms to EN 60715
Enhanced mechanical load capacity	yes, see also Installation instructions for enhanced mechanical load capacity [▶ 158]
Vibration/shock resistance	conforms to EN 60068-2-6 / EN 60068-2-27
EMC immunity/emission	conforms to EN 61000-6-2 / EN 61000-6-4
Protection class	IP20
Installation position	variable
Marking / Approval ^{*)}	CE, EAC, UKCA cULus [▶ 154]

*) Real applicable approvals/markings see type plate on the side (product marking).

2.4.3.3 EL3142-0010 - Connection, display and diagnostics

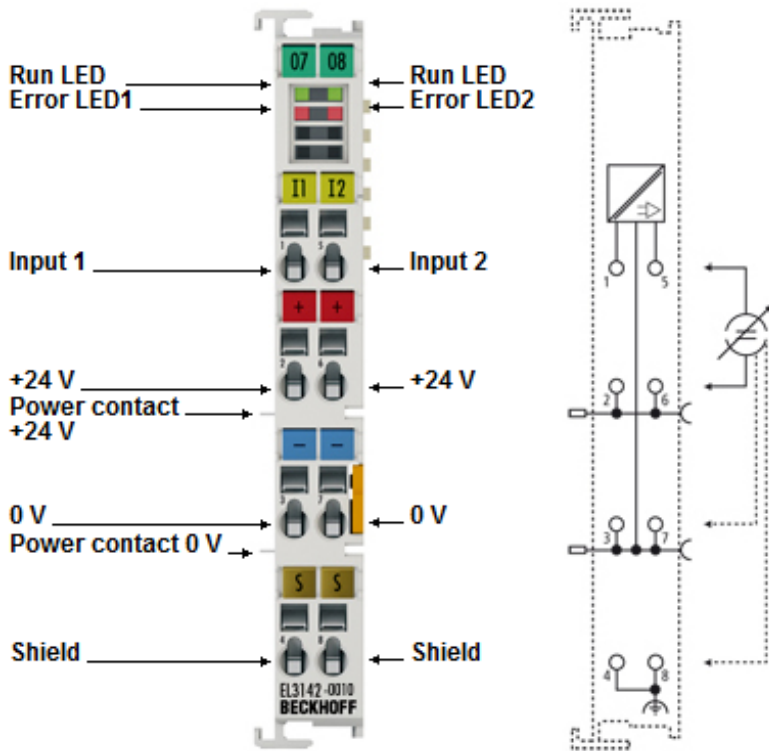

Fig. 31: EL3142-0010 - LEDs and connection

Connection EL3142-0010				
Terminal point		Description	Internally connected with connection	Max. current carrying capacity *)
Name	No.			
+ Input 1	1	+ Input 1	-	40 mA
+24 V	2	+24 V	6, positive power contact	1 A
0 V	3	0 V	7, negative power contact	1 A
Shield	4	Shield (FE)	8; DIN rail	100 mA **)
+ Input 2	5	+ Input 2	-	40 mA
+24 V	6	+24 V	2, positive power contact	1 A
0 V	7	0 V	3, negative power contact	1 A
Shield	8	Shield (FE)	4; DIN rail	100 mA **)

*) Constant and peak value

***) Shield lines should be de-energized!

● Overcurrent protection of the 20 mA inputs

I The current inputs are protected against damage by overcurrent by an internal current limitation, currents > 30mA may occur. In the event of a fault, the current limiter must not be overloaded by a voltage > 30V from the source device.

Overcurrent is displayed in the process image as "Overrange". After occurrence, the error condition must be stopped immediately, the source device switched off or disconnected from the input terminal. If the error condition persists for a longer period of time, the internal terminal current limitation reduces the absorbed signal current for thermal reasons, depending on the ambient conditions also below 20 mA.

LEDs			
LED	Color	Meaning	
RUN*	green	This LED indicates the terminal's operating state *:	
		off	State of the EtherCAT State Machine [▶ 139]: INIT = initialization of the terminal or BOOTSTRAP = function for <u>firmware updates</u> [▶ 491] of the terminal
		flashing	State of the EtherCAT State Machine: PREOP = function for mailbox communication and different standard-settings set
		single flash	State of the EtherCAT State Machine: SAFEOP = verification of the <u>Sync Manager</u> [▶ 219] channels and the distributed clocks. Outputs remain in safe state
		on	State of the EtherCAT State Machine: OP = normal operating state; mailbox and process data communication is possible
ERROR**	red	Fault indication in the event of undershooting or overshooting of the measuring range	
*) If several RUN LEDs are present, all of them have the same function			
**) The error display shows the signal processing state for each channel			

2.4.4 EL3144

2.4.4.1 EL3144 - Introduction

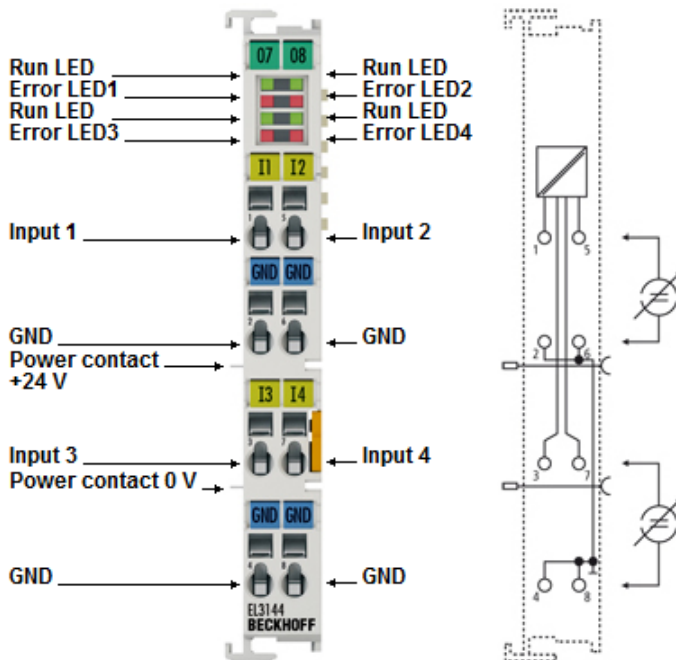

Fig. 32: EL3144

Analog Input Terminal; 4 channel, current, ± 10 mA, 16 bit, single-ended

The EL3144 analog input terminal processes signals in the range between 0 and 20 mA. The current is digitized to a resolution of 16 bits and is transmitted (electrically isolated) to the higher-level automation device.

The EL3144 EtherCAT Terminal features 2-wire conductors for the four single-ended inputs with a common internal ground potential.

The power contacts are connected through. The signal state of the EtherCAT Terminal is indicated by light emitting diodes.

Quick-Links

- [EtherCAT basics](#)
- [Process data and operation modes \[► 244\]](#)
- [Object description and parameterization \[► 392\]](#)

2.4.4.2 EL3144 - Technical data

Technical data	EL3144
Analog inputs	4
Signal current	0 mA...20 mA
Internal resistance	85 Ω type. + diode voltage
Resolution	16 bit (including sign)
Sampling type	multiplex
Ground reference	single-ended
Conversion time (default setting: 50 Hz filter)	approx. 100 µs
Input filter limit frequency	5 kHz
Measuring error (full measuring range)	< ± 0.3% (at 0 °C ... +55 °C, relative to the full scale value) < ± 0.5% (when the extended temperature range is used)
Supply voltage for electronic	via the E-bus
Current consumption via E-bus	typ. 130 mA
Distributed Clocks	yes
Distributed Clocks precision	<< 1 µs
Support NoCoEStorage [▶ 142]	yes
Electrical isolation	500 V (E-bus/field voltage)
Dielectric strength	max. 30 V
Bit width of the process image (default setting)	Inputs: 4 x 16 bit; Status: 4 x 8 bit
Configuration	no address or configuration settings required
Weight	approx. 55 g
Permissible ambient temperature range during operation	-25°C ... +60°C (extended temperature range)
Permissible ambient temperature range during storage	-40°C ... +85°C
Permissible relative humidity	95%, no condensation
Dimensions (W x H x D)	approx. 15 mm x 100 mm x 70 mm (width aligned: 12 mm)
Mounting [▶ 155]	on 35 mm mounting rail conforms to EN 60715
Enhanced mechanical load capacity	yes, see also Installation instructions for enhanced mechanical load capacity [▶ 158]
Vibration/shock resistance	conforms to EN 60068-2-6 / EN 60068-2-27
EMC immunity/emission	conforms to EN 61000-6-2 / EN 61000-6-4
Protection class	IP20
Installation position	variable
Marking / Approval ^{*)}	CE, EAC, UKCA ATEX [▶ 149] , IECEX [▶ 150] , cULus [▶ 154]

*) Real applicable approvals/markings see type plate on the side (product marking).

Ex markings

Standard	Marking
ATEX	II 3 G Ex nA IIC T4 Gc
IECEX	Ex nA IIC T4 Gc

2.4.4.3 EL3144 - Connection, display and diagnostics

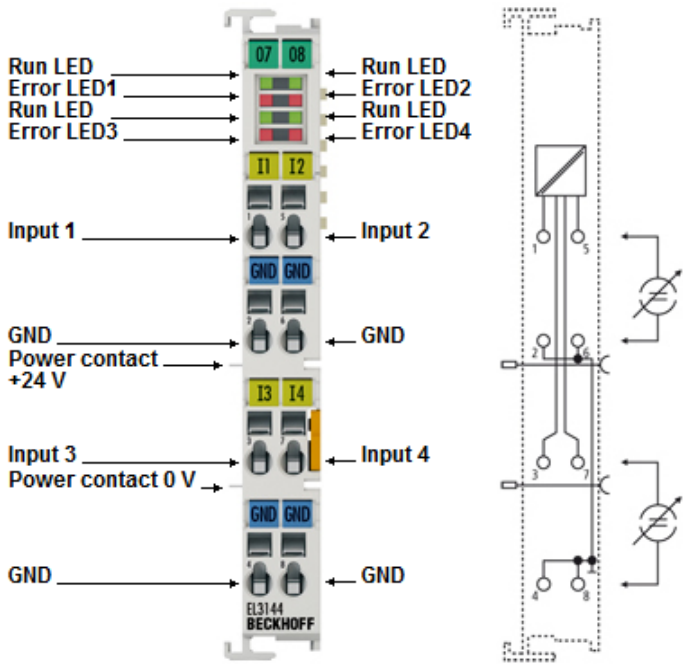

Fig. 33: EI3144 - LEDs and connection

Connection EL3144				
Terminal point		Description	Internally connected with connection	Max. current carrying capacity *)
Name	No.			
Input 1	1	Input 1	-	40 mA
GND	2	Signal ground for input 1	4, 6, 8	40 mA
Input 3	3	Input 2	-	40 mA
GND	4	Signal ground for input 2	2, 6, 8	40 mA
Input 2	5	Input 3	-	40 mA
GND	6	Signal ground for input 3	2, 4, 8	40 mA
Input 4	7	Input 4	-	40 mA
GND	8	Signal ground for input 4	2, 4, 6	40 mA

*) Constant and peak value

NOTICE

Terminal GND and system GND

The signal ground GND of this terminal is not internally connected to the negative power contact. This design allows GND to be connected to a ground other than the negative power contact "Power contact 0V" if necessary.

If disturbing potential differences occur, GND must be electrically connected to the system GND or another suitable ground.

● Overcurrent protection of the 20 mA inputs

i The current inputs are protected against damage by overcurrent by an internal current limitation, currents > 30mA may occur. In the event of a fault, the current limiter must not be overloaded by a voltage > 30V from the source device.

Overcurrent is displayed in the process image as "Overrange". After occurrence, the error condition must be stopped immediately, the source device switched off or disconnected from the input terminal. If the error condition persists for a longer period of time, the internal terminal current limitation reduces the absorbed signal current for thermal reasons, depending on the ambient conditions also below 20 mA.

LEDs			
LED	Color	Meaning	
RUN*	green	This LED indicates the terminal's operating state *:	
		off	State of the EtherCAT State Machine [▶ 139]: INIT = initialization of the terminal or BOOTSTRAP = function for <u>firmware updates</u> [▶ 491] of the terminal
		flashing	State of the EtherCAT State Machine: PREOP = function for mailbox communication and different standard-settings set
		single flash	State of the EtherCAT State Machine: SAFEOP = verification of the <u>Sync Manager</u> [▶ 219] channels and the distributed clocks. Outputs remain in safe state
		on	State of the EtherCAT State Machine: OP = normal operating state; mailbox and process data communication is possible
ERROR**	red	Fault indication in the event of undershooting or overshooting of the measuring range	
*) If several RUN LEDs are present, all of them have the same function			
**) The error display shows the signal processing state for each channel			

2.5 EL315x

2.5.1 EL3151

2.5.1.1 EL3151 - Introduction

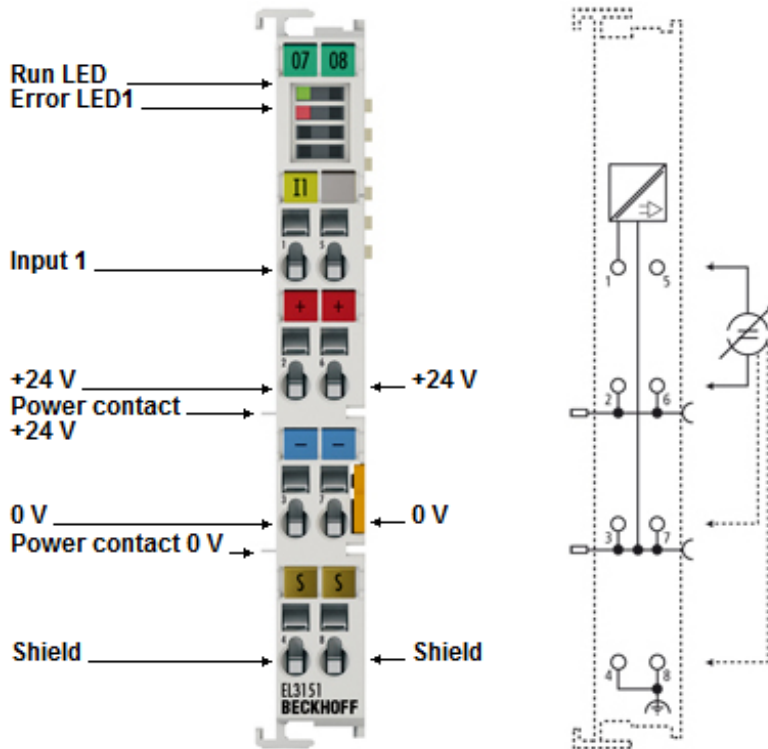

Fig. 34: EL3151

Analog Input Terminal; 1 channel, current, 4...20 mA, 16 bit, single-ended

The job of the EL3151 analog input terminal is to supply power to measuring transducers located in the field and to transmit analog measurement signals with electrical isolation to the automation device.

The voltage for the sensors is supplied to the terminals via the power contacts. The power contacts can optionally be supplied with operating voltage in the standard way or via a supply terminal (EL9xxx) with electrical isolation. The input electronics are independent of the supply voltage of the power contacts.

The reference potential for the inputs is the 0 V power contact. The EtherCAT Terminal indicates its signal state by means of light emitting diodes. The error LEDs indicate an overload condition and a broken wire.

Quick-Links

- [EtherCAT basics](#)
- [Process data and operating modes \[▶ 244\]](#)
- [Object description and parameterization \[▶ 401\]](#)

2.5.1.2 EL3151 - Technical data

Technical data	EL3151
Analog inputs	1
Signal current	4 mA...20 mA
Internal resistance	85 Ω type. + diode voltage
Resolution	16 bit (including sign)
Sampling type	simultaneous
Ground reference	single-ended
Conversion time (default setting: 50 Hz filter)	approx. 40 μs (
Input filter limit frequency	5 kHz
Measuring error (full measuring range)	< ± 0.3% (at 0 °C ... +55 °C, relative to the full scale value) < ± 0.5% (when the extended temperature range is used)
Supply voltage for internal electronic	via the E-bus
Current consumption via E-bus	typ. 130 mA
Distributed Clocks	yes
Distributed Clocks precision	<< 1 μs
Support NoCoEStorage [▶ 142]	yes
Electrical isolation	500 V (E-bus/field voltage)
Dielectric strength	max. 30 V
Bit width of the process image (default setting)	Inputs: 1 x 16 bit; Status: 1 x 8 bit
Configuration	no address or configuration settings required
Weight	approx. 60 g
Permissible ambient temperature range during operation	-25°C ... +60°C (extended temperature range)
Permissible ambient temperature range during storage	-40°C ... +85°C
Permissible relative humidity	95%, no condensation
Dimensions (W x H x D)	approx. 15 mm x 100 mm x 70 mm (width aligned: 12 mm)
Mounting [▶ 155]	on 35 mm mounting rail conforms to EN 60715
Enhanced mechanical load capacity	yes, see also Installation instructions for enhanced mechanical load capacity [▶ 158]
Vibration/shock resistance	conforms to EN 60068-2-6 / EN 60068-2-27
EMC immunity/emission	conforms to EN 61000-6-2 / EN 61000-6-4
Protection class	IP20
Installation position	variable
Marking / Approval*)	CE, EAC, UKCA ATEX [▶ 149], IECEx [▶ 150], cFMus [▶ 152], cULus [▶ 154]

*) Real applicable approvals/markings see type plate on the side (product marking).

Ex markings

Standard	Marking
ATEX	II 3 G Ex nA IIC T4 Gc
IECEx	Ex nA IIC T4 Gc
cFMus	Class I, Division 2, Groups A, B, C, D Class I, Zone 2, AEx/Ex ec IIC T4 Gc

2.5.1.3 EL3151 - Connection, display and diagnostics

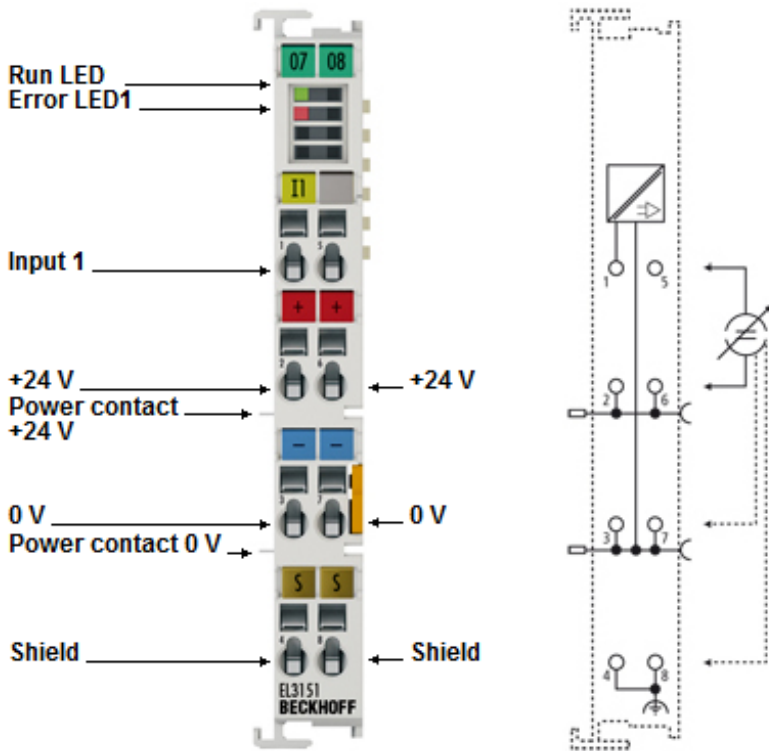

Fig. 35: EL3151 - LEDs and connection

Connection EL3151				
Terminal point		Description	Internally connected with connection	Max. current carrying capacity *)
Name	No.			
Input 1	1	+ Input 1	-	40 mA
+24 V	2	+24 V	6, positive power contact	1 A
0 V	3	0 V	7, negative power contact	1 A
Shield	4	Shield (FE)	8; DIN rail	100 mA **)
n. c.	5	not connected	-	-
+24 V	6	+24 V	2, positive power contact	1 A
0 V	7	0 V	3, negative power contact	1 A
Shield	8	Shield (FE)	4; DIN rail	100 mA **)

*) Constant and peak value

***) Shield lines should be de-energized!

● Overcurrent protection of the 20 mA inputs

I The current inputs are protected against damage by overcurrent by an internal current limitation, currents > 30mA may occur. In the event of a fault, the current limiter must not be overloaded by a voltage > 30V from the source device.

Overcurrent is displayed in the process image as "Overrange". After occurrence, the error condition must be stopped immediately, the source device switched off or disconnected from the input terminal. If the error condition persists for a longer period of time, the internal terminal current limitation reduces the absorbed signal current for thermal reasons, depending on the ambient conditions also below 20 mA.

LEDs			
LED	Color	Meaning	
RUN*	green	This LED indicates the terminal's operating state *:	
		off	State of the EtherCAT State Machine [▶ 139] : INIT = initialization of the terminal or BOOTSTRAP = function for firmware updates [▶ 491] of the terminal
		flashing	State of the EtherCAT State Machine: PREOP = function for mailbox communication and different standard-settings set
		single flash	State of the EtherCAT State Machine: SAFEOP = verification of the Sync Manager [▶ 219] channels and the distributed clocks. Outputs remain in safe state
		on	State of the EtherCAT State Machine: OP = normal operating state; mailbox and process data communication is possible
ERROR**	red	Fault indication in the event of undershooting or overshooting of the measuring range	
*) If several RUN LEDs are present, all of them have the same function			
**) The error display shows the signal processing state for each channel			

2.5.2 EL3152

2.5.2.1 EL3152 - Introduction

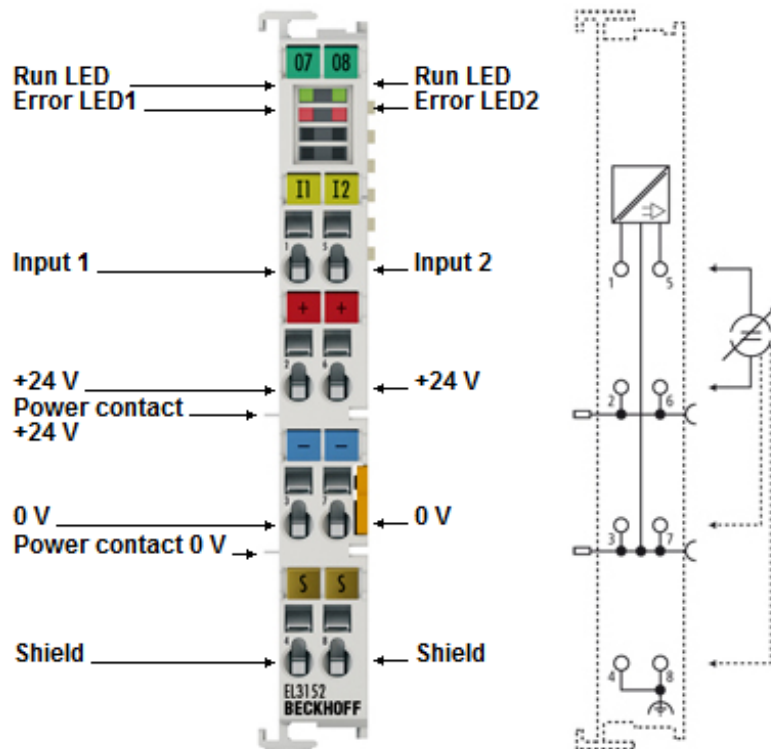

Fig. 36: EL3152

Analog Input Terminal; 2 channel, current, 4...20 mA, 16 bit, single-ended

The job of the EL3152 analog input terminal is to supply power to measuring transducers located in the field and to transmit analog measurement signals with electrical isolation to the automation device.

The voltage for the sensors is supplied to the terminals via the power contacts. The power contacts can optionally be supplied with operating voltage in the standard way or via a supply terminal (EL9xxx) with electrical isolation. The input electronics are independent of the supply voltage of the power contacts.

The reference potential for the inputs is the 0 V power contact. The EtherCAT Terminal indicates its signal state by means of light emitting diodes. The error LEDs indicate an overload condition and a broken wire.

Quick-Links

- [EtherCAT basics](#)
- [Process data and operating modes \[► 244\]](#)
- [Object description and parameterization \[► 408\]](#)

2.5.2.2 EL3152 - Technical data

Technical data	EL3152
Analog inputs	2
Signal current	4 mA...20 mA
Internal resistance	85 Ω type. + diode voltage
Resolution	16 bit (including sign)
Sampling type	simultaneous
Ground reference	single-ended
Conversion time (default setting: 50 Hz filter)	approx. 50 μs (Fast-Mode: approx. 35 μs)
Input filter limit frequency	5 kHz
Measuring error (full measuring range)	< ± 0.3% (at 0 °C ... +55 °C, relative to the full scale value) < ± 0.5% (when the extended temperature range is used)
Supply voltage for internal electronic	via the E-bus
Current consumption via E-bus	typ. 170 mA
Distributed Clocks	yes (from Rev. Rev. EL315x-0000-0017 [▶ 484])
Distributed Clocks precision	<< 1 μs
Support NoCoEStorage [▶ 142]	yes
Electrical isolation	500 V (E-bus/field voltage)
Dielectric strength	max. 30 V
Bit width of the process image (default setting)	Inputs: 2 x 16 bit; Status: 2 x 8 bit
Configuration	no address or configuration settings required
Weight	approx. 60 g
Permissible ambient temperature range during operation	-25°C ... +60°C (extended temperature range)
Permissible ambient temperature range during storage	-40°C ... +85°C
Permissible relative humidity	95%, no condensation
Dimensions (W x H x D)	approx. 15 mm x 100 mm x 70 mm (width aligned: 12 mm)
Mounting [▶ 155]	on 35 mm mounting rail conforms to EN 60715
Enhanced mechanical load capacity	yes, see also Installation instructions for enhanced mechanical load capacity [▶ 158]
Vibration/shock resistance	conforms to EN 60068-2-6 / EN 60068-2-27
EMC immunity/emission	conforms to EN 61000-6-2 / EN 61000-6-4
Protection class	IP20
Installation position	variable
Marking / Approval*)	CE, EAC, UKCA ATEX [▶ 149] , IECEX [▶ 150] , cFMus [▶ 152] , cULus [▶ 154]

*) Real applicable approvals/markings see type plate on the side (product marking).

Ex markings

Standard	Marking
ATEX	II 3 G Ex nA IIC T4 Gc
IECEX	Ex nA IIC T4 Gc
cFMus	Class I, Division 2, Groups A, B, C, D Class I, Zone 2, AEx/Ex ec IIC T4 Gc

2.5.2.3 EL3152 - Connection, display and diagnostics

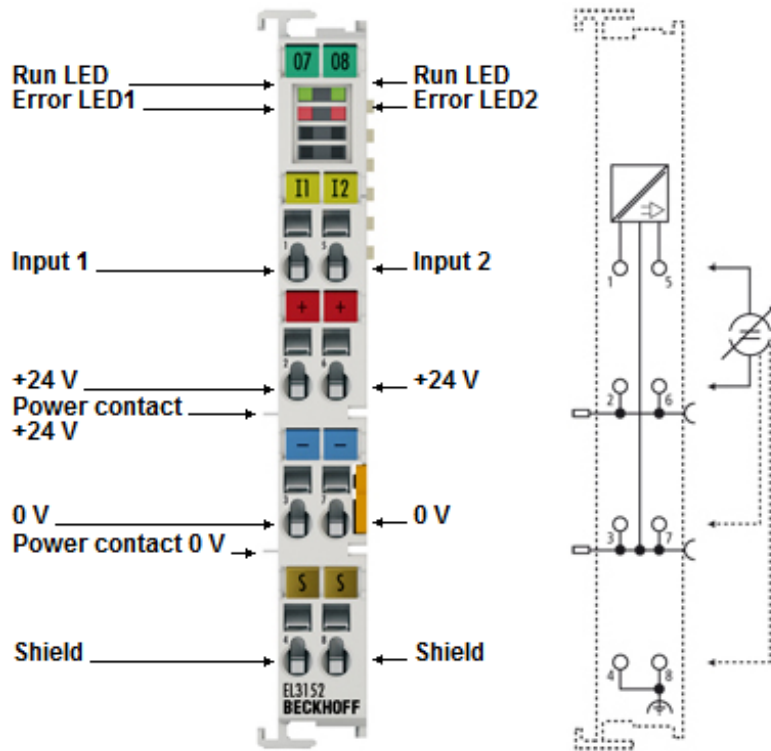

Fig. 37: EL3152 - LEDs and connection

Connection EL3152				
Terminal point		Description	Internally connected with connection	Max. current carrying capacity *)
Name	No.			
+ Input 1	1	+ Input 1	-	40 mA
+24 V	2	+24 V	6, positive power contact	1 A
0 V	3	0 V	7, negative power contact	1 A
Shield	4	Shield (FE)	8; DIN rail	100 mA **)
+ Input 2	5	+ Input 2	-	40 mA
+24 V	6	+24 V	2, positive power contact	1 A
0 V	7	0 V	3, negative power contact	1 A
Shield	8	Shield (FE)	4; DIN rail	100 mA **)

*) Constant and peak value

***) Shield lines should be de-energized!

● Overcurrent protection of the 20 mA inputs

I The current inputs are protected against damage by overcurrent by an internal current limitation, currents > 30mA may occur. In the event of a fault, the current limiter must not be overloaded by a voltage > 30V from the source device.

Overcurrent is displayed in the process image as "Overrange". After occurrence, the error condition must be stopped immediately, the source device switched off or disconnected from the input terminal. If the error condition persists for a longer period of time, the internal terminal current limitation reduces the absorbed signal current for thermal reasons, depending on the ambient conditions also below 20 mA.

LEDs			
LED	Color	Meaning	
RUN*	green	This LED indicates the terminal's operating state *:	
		off	State of the EtherCAT State Machine [▶ 139]: INIT = initialization of the terminal or BOOTSTRAP = function for <u>firmware updates</u> [▶ 491] of the terminal
		flashing	State of the EtherCAT State Machine: PREOP = function for mailbox communication and different standard-settings set
		single flash	State of the EtherCAT State Machine: SAFEOP = verification of the <u>Sync Manager</u> [▶ 219] channels and the distributed clocks. Outputs remain in safe state
on	State of the EtherCAT State Machine: OP = normal operating state; mailbox and process data communication is possible		
ERROR**	red	Fault indication in the event of undershooting or overshooting of the measuring range	
*) If several RUN LEDs are present, all of them have the same function			
**) The error display shows the signal processing state for each channel			

2.5.3 EL3154

2.5.3.1 EL3154 - Introduction

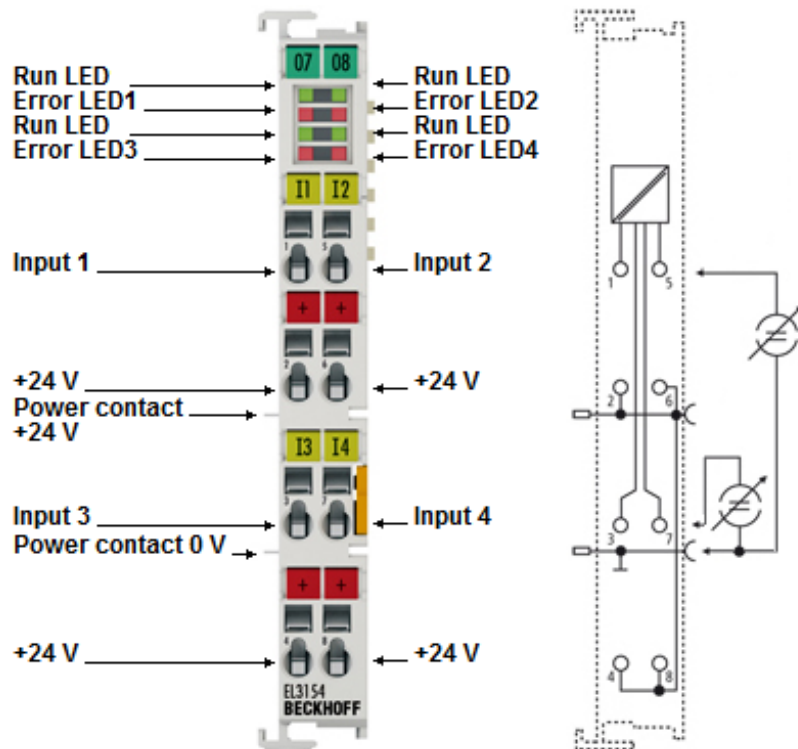

Fig. 38: EL3154

Analog Input Terminal; 4 channel, current, 4...20 mA, 16 bit, single-ended

The EL3154 analog input terminal processes signals in the range between 4 and 20 mA. The current is digitized to a resolution of 16 bits and is transmitted (electrically isolated) to the higher-level automation device.

The input electronics are independent of the supply voltage of the power contacts. In the EL3154 with four inputs, the 24 V power contact is connected to the terminal in order to enable connection of 2-wire sensors without external supply.

The power contacts are connected through. The signal state of the EtherCAT Terminal is indicated by light emitting diodes. The error LEDs indicate an overload condition and a broken wire.

Quick-Links

- [EtherCAT basics](#)
- [Process data and operation modes \[► 244\]](#)
- [Object description and parameterization \[► 420\]](#)

2.5.3.2 EL3154 - Technical data

Technical data	EL3154
Analog inputs	4
Signal current	4 mA...20 mA
Internal resistance	85 Ω type. + diode voltage
Resolution	16 bit (including sign)
Sampling type	multiplex
Ground reference	single-ended
Conversion time (default setting: 50 Hz filter)	approx. 100 μs
Input filter limit frequency	5 kHz
Measuring error (full measuring range)	< ± 0.3% (at 0 °C ... +55 °C, relative to the full scale value) < ± 0.5% (when the extended temperature range is used)
Supply voltage for internal electronic	via the E-bus
Current consumption via E-bus	typ. 130 mA
Distributed Clocks	yes
Distributed Clocks precision	<< 1 μs
Support NoCoEStorage [▶ 142]	yes
Electrical isolation	500 V (E-bus/field voltage)
Dielectric strength	max. 30 V
Bit width of the process image (default setting)	Inputs: 4 x 16 bit; Status: 4 x 8 bit
Configuration	no address or configuration settings required
Weight	approx. 60 g
Permissible ambient temperature range during operation	-25°C ... +60°C (extended temperature range)
Permissible ambient temperature range during storage	-40°C ... +85°C
Permissible relative humidity	95%, no condensation
Dimensions (W x H x D)	approx. 15 mm x 100 mm x 70 mm (width aligned: 12 mm)
Mounting [▶ 155]	on 35 mm mounting rail conforms to EN 60715
Enhanced mechanical load capacity	yes, see also Installation instructions for enhanced mechanical load capacity [▶ 158]
Vibration/shock resistance	conforms to EN 60068-2-6 / EN 60068-2-27
EMC immunity/emission	conforms to EN 61000-6-2 / EN 61000-6-4
Protection class	IP20
Installation position	variable
Marking / Approval ^{*)}	CE, EAC, UKCA ATEX [▶ 149], IECEx [▶ 150], cFMus [▶ 152], cULus [▶ 154]

*) Real applicable approvals/markings see type plate on the side (product marking).

Ex markings

Standard	Marking
ATEX	II 3 G Ex nA IIC T4 Gc II 3 D Ex tc IIIC T135 °C Dc
IECEX	Ex nA IIC T4 Gc Ex tc IIIC T135 °C Dc
cFMus	Class I, Division 2, Groups A, B, C, D Class I, Zone 2, AEx/Ex ec IIC T4 Gc

2.5.3.3 EL3154 - Connection, display and diagnostics

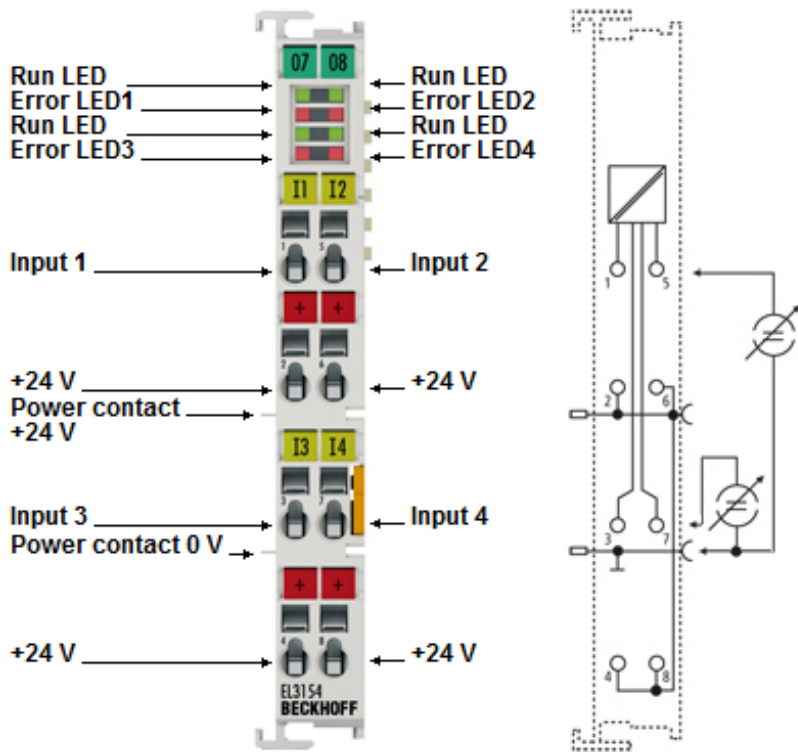

Fig. 39: EL3154 - LEDs and connection

Connection EL3154				
Terminal point		Description	Internally connected with connection	Max. current carrying capacity *)
Name	No.			
Input 1	1	Input 1	-	40 mA
GND	2	Signal ground for input 1	4, 6, 8	40 mA
Input 3	3	Input 2	-	40 mA
GND	4	Signal ground for input 2	2, 6, 8	40 mA
Input 2	5	Input 3	-	40 mA
GND	6	Signal ground for input 3	2, 4, 8	40 mA
Input 4	7	Input 4	-	40 mA
GND	8	Signal ground for input 4	2, 4, 6	40 mA

*) Constant and peak value

i Overcurrent protection of the 20 mA inputs

The current inputs are protected against damage by overcurrent by an internal current limitation, currents > 30mA may occur. In the event of a fault, the current limiter must not be overloaded by a voltage > 30V from the source device.

Overcurrent is displayed in the process image as "Overrange". After occurrence, the error condition must be stopped immediately, the source device switched off or disconnected from the input terminal. If the error condition persists for a longer period of time, the internal terminal current limitation reduces the absorbed signal current for thermal reasons, depending on the ambient conditions also below 20 mA.

LEDs			
LED	Color	Meaning	
RUN*	green	This LED indicates the terminal's operating state *:	
		off	State of the EtherCAT State Machine [▶ 139]: INIT = initialization of the terminal or BOOTSTRAP = function for <u>firmware updates</u> [▶ 491] of the terminal
		flashing	State of the EtherCAT State Machine: PREOP = function for mailbox communication and different standard-settings set
		single flash	State of the EtherCAT State Machine: SAFEOP = verification of the <u>Sync Manager</u> [▶ 219] channels and the distributed clocks. Outputs remain in safe state
on	State of the EtherCAT State Machine: OP = normal operating state; mailbox and process data communication is possible		
ERROR**	red	Fault indication in the event of undershooting or overshooting of the measuring range	
*) If several RUN LEDs are present, all of them have the same function			
**) The error display shows the signal processing state for each channel			

2.6 EL316x

2.6.1 EL3161

2.6.1.1 EL3161 - Introduction

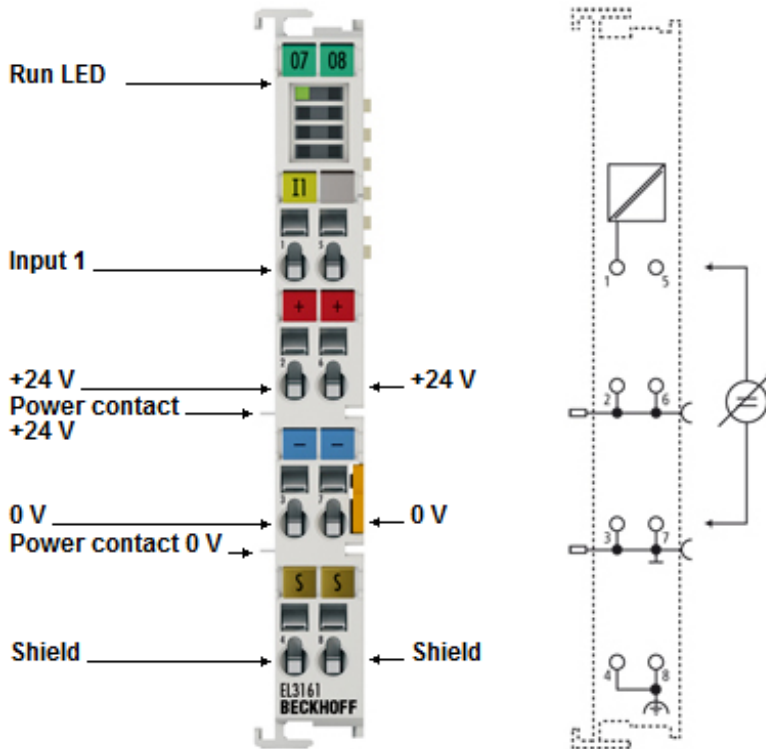

Fig. 40: EL3161

Analog Input Terminal; 1 channel, voltage, 0...10 V, 16 bit, single-ended

The EL3161 analog input terminal processes signals in the range between 0 and 10 V. The voltage is digitized to a resolution of 16 bits, and is transmitted, electrically isolated, to the higher-level automation device.

The input channels of the EtherCAT Terminal have the reference ground as common ground potential. The signal state of the EtherCAT Terminal is indicated by light emitting diodes.

Quick-Links

- [EtherCAT basics](#)
- [Process data and operating modes \[► 244\]](#)
- [Object description and parameterization \[► 429\]](#)

2.6.1.2 EL3161 - Technical data

Technical data	EL3161
analog inputs	1
Signal voltage	0 ...+10 V
Internal resistance	> 200 kΩ
Resolution	16 bit (including sign)
Sampling type	simultaneous
Ground reference	single-ended
Conversion time (default setting: 50 Hz filter)	approx. 35 μs
Input filter limit frequency	5 kHz
Measuring error (full measuring range)	< ±0.3 % (relative to full scale value)
Supply voltage for electronic	via the E-bus
Current consumption via E-bus	typ. 130 mA
Distributed Clocks	yes
Distributed Clocks precision	<< 1 μs
Support NoCoEStorage [▶ 142]	yes
Electrical isolation	500 V (E-bus/field voltage)
Dielectric strength	max. 30 V
Bit width of the process image (default setting)	Inputs: 1 x 16 bit; Status: 1 x 8 bit
Configuration	no address or configuration settings required
Weight	approx. 60 g
Permissible ambient temperature range during operation	0°C ... +55°C
Permissible ambient temperature range during storage	-25°C ... +85°C
Permissible relative humidity	95%, no condensation
Dimensions (W x H x D)	approx. 15 mm x 100 mm x 70 mm (width aligned: 12 mm)
Mounting [▶ 155]	on 35 mm mounting rail conforms to EN 60715
Enhanced mechanical load capacity	yes, see also Installation instructions for enhanced mechanical load capacity [▶ 158]
Vibration/shock resistance	conforms to EN 60068-2-6 / EN 60068-2-27
EMC immunity/emission	conforms to EN 61000-6-2 / EN 61000-6-4
Protection class	IP20
Installation position	variable
Marking / Approval ^{*)}	CE, EAC, UKCA ATEX [▶ 148], IECEx [▶ 150], cULus [▶ 154]

*) Real applicable approvals/markings see type plate on the side (product marking).

Ex markings

Standard	Marking
ATEX	II 3 G Ex nA IIC T4 Gc
IECEX	Ex nA IIC T4 Gc

2.6.1.3 EL3161 - Connection, display and diagnostics

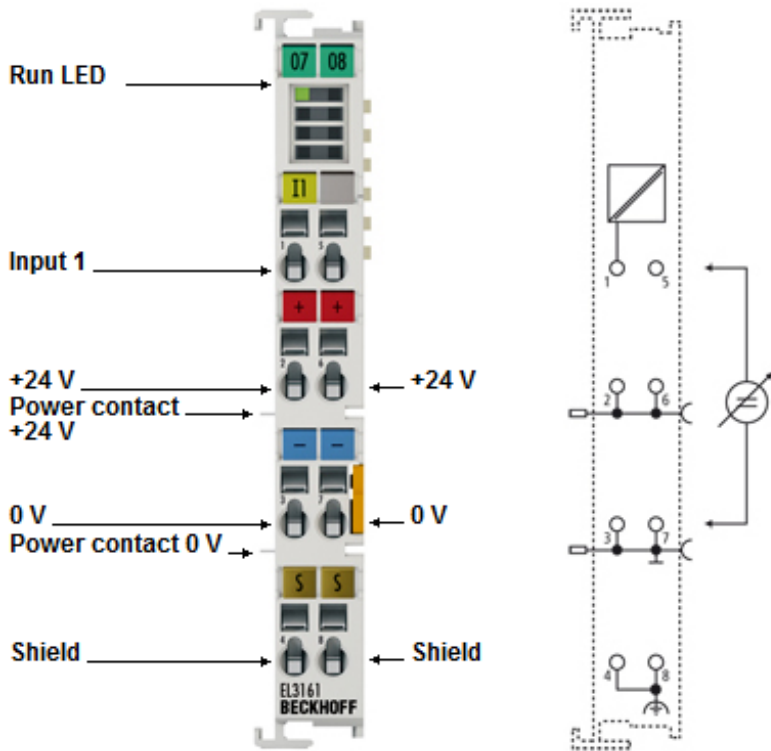

Fig. 41: EL3161 - LEDs and connection

Connection EL3161				
Terminal point		Description	Internally connected with connection	Max. current carrying capacity *)
Name	No.			
+ Input 1	1	+ Input 1	-	not applicable (voltage input)
+24 V	2	+24 V	6, positive power contact	1 A
0 V	3	0 V	7, negative power contact	1 A
Shield	4	Shield (FE)	8; DIN rail	100 mA **)
n. c.	5	not connected	-	-
+24 V	6	+24 V	2, positive power contact	1 A
0 V	7	0 V	3, negative power contact	1 A
Shield	8	Shield (FE)	4; DIN rail	100 mA **)

*) Constant and peak value

***) Shield lines should be de-energized!

LEDs			
LED	Color	Meaning	
RUN*	green	This LED indicates the terminal's operating state (if more than one RUN LED is present, all of them have the same function):	
		off	State of the EtherCAT State Machine [▶ 139]: INIT = initialization of the terminal or BOOTSTRAP = function for firmware updates [▶ 491] of the terminal
		flashing	State of the EtherCAT State Machine: PREOP = function for mailbox communication and different standard-settings set
		single flash	State of the EtherCAT State Machine: SAFEOP = verification of the Sync Manager [▶ 219] channels and the distributed clocks. Outputs remain in safe state
on	State of the EtherCAT State Machine: OP = normal operating state; mailbox and process data communication is possible		

*) If several RUN LEDs are present, all of them have the same function

2.6.2 EL3162

2.6.2.1 EL3162 - Introduction

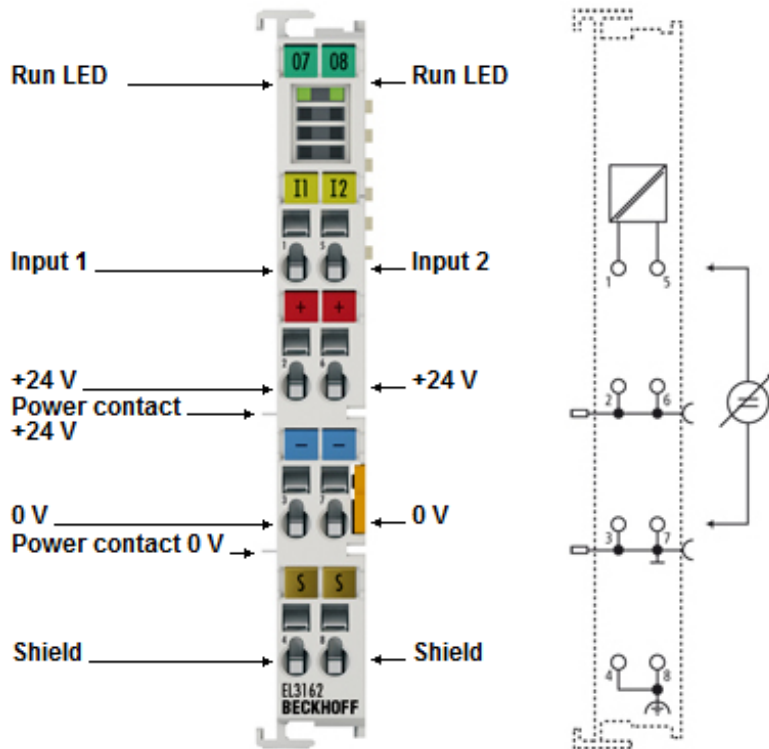

Fig. 42: EL3162

Analog Input Terminal; 2 channel, voltage, 0...10 V, 16 bit, single-ended

The EL3162 analog input terminal processes signals in the range between 0 and 10 V. The voltage is digitized to a resolution of 16 bits, and is transmitted, electrically isolated, to the higher-level automation device.

The input channels of the EtherCAT Terminal have the reference ground as common ground potential. The signal state of the EtherCAT Terminal is indicated by light emitting diodes.

Quick-Links

- [EtherCAT basics](#)
- [Process data and operating modes \[► 244\]](#)
- [Object description and parameterization \[► 436\]](#)

2.6.2.2 EL3162 - Technical data

Technical data	EL3162
analog inputs	2
Signal voltage	0 ... +10 V
Internal resistance	> 200 kΩ
Resolution	16 bit (including sign)
Sampling type	simultaneous
Ground reference	single-ended
Conversion time (default setting: 50 Hz filter)	approx. 50 μs
Input filter limit frequency	5 kHz
Measuring error (full measuring range)	< ±0.3 % (relative to full scale value)
Supply voltage for electronic	via the E-bus
Current consumption via E-bus	typ. 170 mA
Distributed Clocks	yes (from rev. EL316x-0000-0017 [▶ 484])
Distributed Clocks precision	<< 1 μs
Support NoCoEStorage [▶ 142]	yes
Electrical isolation	500 V (E-bus/field voltage)
Dielectric strength	max. 30 V
Bit width of the process image (default setting)	Inputs: 2 x 16 bit; Status: 2 x 8 bit
Configuration	no address or configuration settings required
Weight	approx. 60 g
Permissible ambient temperature range during operation	0°C ... +55°C
Permissible ambient temperature range during storage	-25°C ... +85°C
Permissible relative humidity	95%, no condensation
Dimensions (W x H x D)	approx. 15 mm x 100 mm x 70 mm (width aligned: 12 mm)
Mounting [▶ 155]	on 35 mm mounting rail conforms to EN 60715
Enhanced mechanical load capacity	yes, see also Installation instructions for enhanced mechanical load capacity [▶ 158]
Vibration/shock resistance	conforms to EN 60068-2-6 / EN 60068-2-27
EMC immunity/emission	conforms to EN 61000-6-2 / EN 61000-6-4
Protection class	IP20
Installation position	variable
Marking / Approval ^{*)}	CE, EAC, UKCA ATEX [▶ 148], IECEx [▶ 150], cULus [▶ 154]

*) Real applicable approvals/markings see type plate on the side (product marking).

Ex markings

Standard	Marking
ATEX	II 3 G Ex nA IIC T4 Gc
IECEx	Ex nA IIC T4 Gc

2.6.2.3 EL3162 - Connection, display and diagnostics

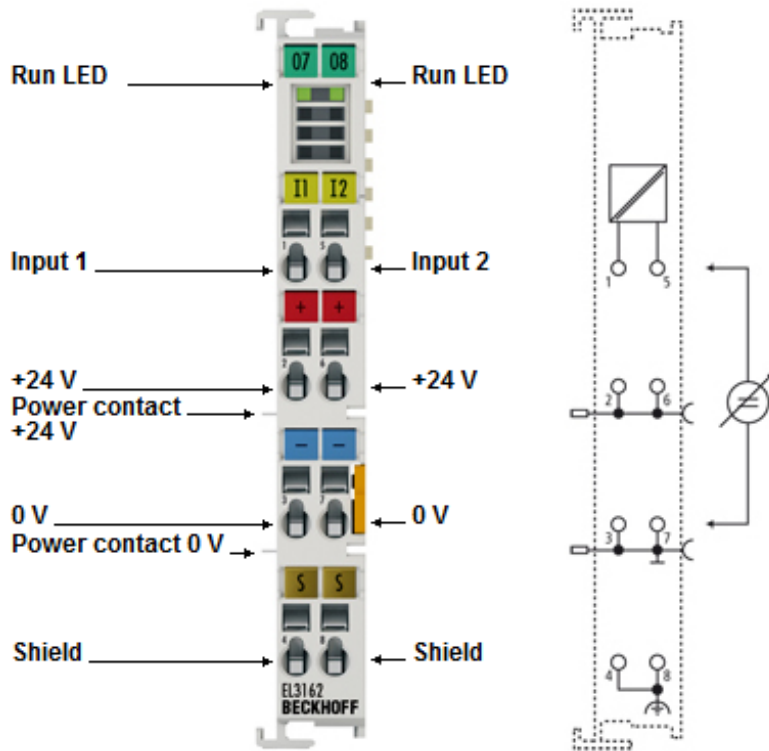

Fig. 43: EL3162 - LEDs and connection

Connection EL3162				
Terminal point		Description	Internally connected with connection	Max. current carrying capacity *)
Name	No.			
+ Input 1	1	+ Input 1	-	not applicable (voltage input)
+24 V	2	+24 V	6, positive power contact	1 A
0 V	3	0 V	7, negative power contact	1 A
Shield	4	Shield (FE)	8; DIN rail	100 mA **)
+ Input 2	5	+ Input 2	-	not applicable (voltage input)
+24 V	6	+24 V	2, positive power contact	1 A
0 V	7	0 V	3, negative power contact	1 A
Shield	8	Shield (FE)	4; DIN rail	100 mA **)

*) Constant and peak value

***) Shield lines should be de-energized!

LEDs			
LED	Color	Meaning	
RUN*	green	This LED indicates the terminal's operating state (if more than one RUN LED is present, all of them have the same function):	
		off	State of the EtherCAT State Machine [▶ 139]: INIT = initialization of the terminal or BOOTSTRAP = function for firmware updates [▶ 491] of the terminal
		flashing	State of the EtherCAT State Machine: PREOP = function for mailbox communication and different standard-settings set
		single flash	State of the EtherCAT State Machine: SAFEOP = verification of the Sync Manager [▶ 219] channels and the distributed clocks. Outputs remain in safe state
		on	State of the EtherCAT State Machine: OP = normal operating state; mailbox and process data communication is possible

*) If several RUN LEDs are present, all of them have the same function

2.6.3 EL3164

2.6.3.1 EL3164 - Introduction

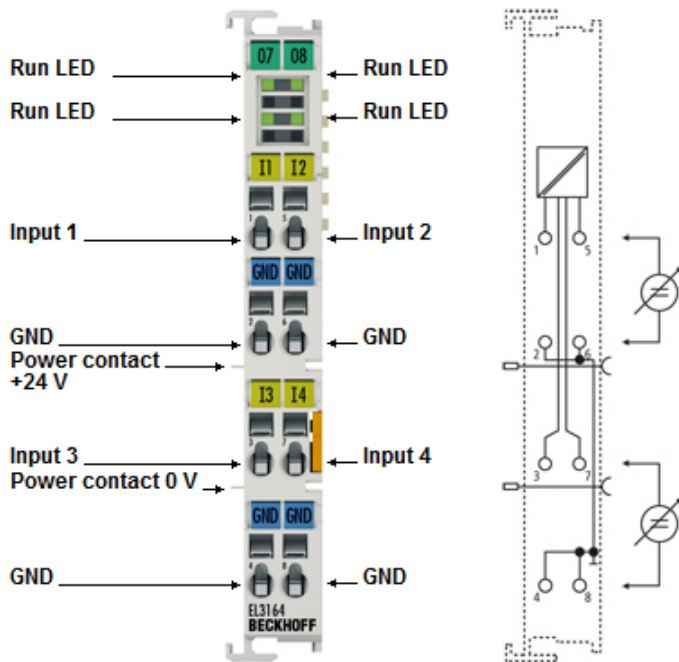

Fig. 44: EL3164

Analog Input Terminal; 4 channel, voltage, 0...10 V, 16 bit, single-ended

The EL3164 analog input terminal processes signals in the range between 0 and 10 V. The voltage is digitized with a resolution of 16 bits and is transmitted (electrically isolated) to the higher-level automation device.

The EL3164 EtherCAT Terminal features 2-wire conductors for the four single-ended inputs with a common internal ground potential. The power contacts are connected through. The signal state of the EtherCAT Terminal is indicated by light emitting diodes.

Quick-Links

- [EtherCAT basics](#)
- [Process data and operation modes \[► 244\]](#)
- [Object description and parameterization \[► 448\]](#)

2.6.3.2 EL3164 - Technical data

Technical data	EL3164
analog inputs	4
Signal voltage	0 ...+10 V
Internal resistance	> 200 kΩ
Resolution	16 bit (including sign)
Sampling type	multiplex
Ground reference	single-ended
Conversion time (default setting: 50 Hz filter)	approx. 100 μs
Input filter limit frequency	5 kHz
Measuring error (full measuring range)	< ±0.3 % (relative to full scale value)
Supply voltage for electronic	via the E-bus
Current consumption via E-bus	typ. 130 mA
Distributed Clocks	yes
Distributed Clocks precision	<< 1 μs
Support NoCoEStorage [▶ 142]	yes
Electrical isolation	500 V (E-bus/field voltage)
Dielectric strength	max. 30 V
Bit width of the process image (default setting)	Inputs: 4 x 16 bit; Status: 4 x 8 bit
Configuration	no address or configuration settings required
Weight	approx. 65 g
Permissible ambient temperature range during operation	0°C ... +55°C
Permissible ambient temperature range during storage	-25°C ... +85°C
Permissible relative humidity	95%, no condensation
Dimensions (W x H x D)	approx. 15 mm x 100 mm x 70 mm (width aligned: 12 mm)
Mounting [▶ 155]	on 35 mm mounting rail conforms to EN 60715
Enhanced mechanical load capacity	yes, see also Installation instructions for enhanced mechanical load capacity [▶ 158]
Vibration/shock resistance	conforms to EN 60068-2-6 / EN 60068-2-27
EMC immunity/emission	conforms to EN 61000-6-2 / EN 61000-6-4
Protection class	IP20
Installation position	variable
Marking / Approval ^{*)}	CE, EAC, UKCA ATEX [▶ 148], IECEx [▶ 150], cULus [▶ 154]

*) Real applicable approvals/markings see type plate on the side (product marking).

Ex markings

Standard	Marking
ATEX	II 3 G Ex nA IIC T4 Gc
IECEX	Ex nA IIC T4 Gc

2.6.3.3 EL3164 - Connection, display and diagnostics

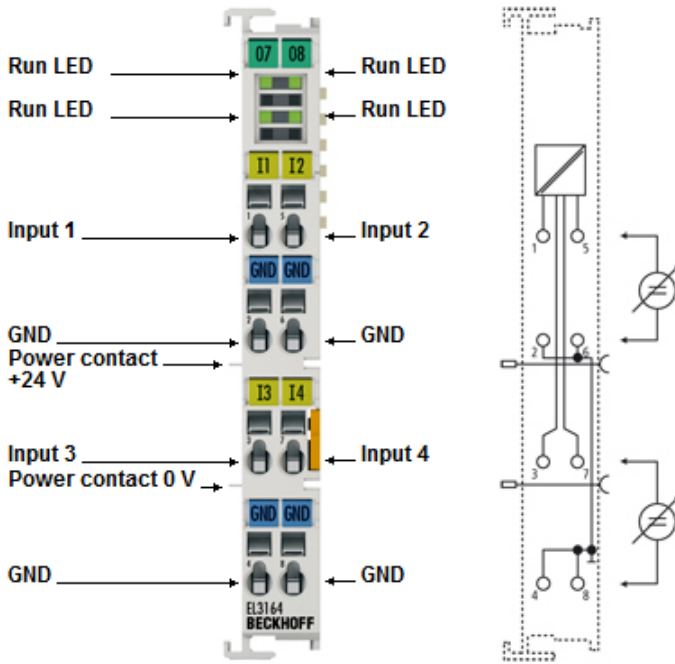

Fig. 45: EL3164 - LEDs and connection

Connection EL3164				
Terminal point		Description	Internally connected with connection	Max. current carrying capacity *)
Name	No.			
Input 1	1	Input 1	-	not applicable (voltage input)
GND	2	Signal ground for input 1	4, 6, 8	40 mA
Input 3	3	Input 2	-	not applicable (voltage input)
GND	4	Signal ground for input 2	2, 6, 8	40 mA
Input 2	5	Input 3	-	not applicable (voltage input)
GND	6	Signal ground for input 3	2, 4, 8	40 mA
Input 4	7	Input 4	-	not applicable (voltage input)
GND	8	Signal ground for input 4	2, 4, 6	40 mA

*) Constant and peak value

● GND connection points

i The GND connection points of the terminal are not connected internally directly, but via EMC protection components. Therefore, each analog encoder/sensor must be connected separately with 2 wires, even if the connection diagram of the terminal for the channels indicates a common ground (GND).

● Current carrying capacity of the input contacts

i The maximum permitted current on the signal-relevant terminal points (inputs, GND) is 40 mA (if applicable).

NOTICE

Terminal GND and system GND

The signal ground GND of this terminal is not internally connected to the negative power contact. This design allows GND to be connected to a ground other than the negative power contact "Power contact 0V" if necessary.

If disturbing potential differences occur, GND must be electrically connected to the system GND or another suitable ground.

LEDs			
LED	Color	Meaning	
RUN*	green	This LED indicates the terminal's operating state (if more than one RUN LED is present, all of them have the same function):	
		off	State of the EtherCAT State Machine [▶ 139] : INIT = initialization of the terminal or BOOTSTRAP = function for firmware updates [▶ 491] of the terminal
		flashing	State of the EtherCAT State Machine: PREOP = function for mailbox communication and different standard-settings set
		single flash	State of the EtherCAT State Machine: SAFEOP = verification of the Sync Manager [▶ 219] channels and the distributed clocks. Outputs remain in safe state
		on	State of the EtherCAT State Machine: OP = normal operating state; mailbox and process data communication is possible
*) If several RUN LEDs are present, all of them have the same function			

2.7 EL317x

2.7.1 EL3172

2.7.1.1 EL3172 - Introduction

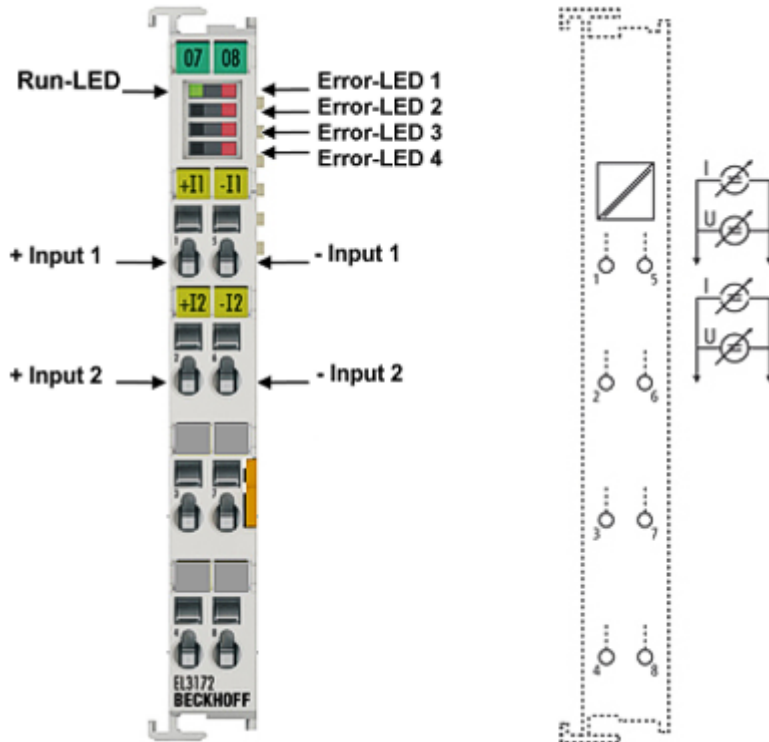

Fig. 46: EL3172

Analog Input Terminal; 2 channel, multi-function, ± 10 V, ± 20 mA, 16 bit

The EL3172 analog input terminal supplements the EL3174, thus 2-channel and 4-channel universal input terminals are now available in the EL31xx family. The EL3172 has two single parameterizable inputs. Signals in the range ± 10 V or ± 25 mA can be processed by each channel, therefore of course also unipolar 0...10 V or 0/4...20 mA.

Each channel should be set by the controller to U or I mode via CoE. The input voltage or current is digitized with a resolution of 16 bits, and is transmitted (electrically isolated) to the higher-level automation device.

With a technical measuring range of $\pm 107\%$ of the nominal range 10 V/20 mA and the 25 mA measuring range, the terminal also supports the commissioning with sensor values in the limit range and the evaluation according to NAMUR NE43. The two differential inputs are electrically isolated from each other and from the fieldbus.

● 107% Extended Range

i The EL3172 is preconfigured to a measurement range of 107% (e.g. 0x7FFF correspond to +10.737 V or 3.22 V accordingly). Via CoE access can be reset to the previously known legacy range. Then 0x7FFF correspond to the full scale value or e.g. 10 V (3 V) as before.

Quick-Links

- [EtherCAT basics](#)
- [Process data and operating modes \[► 244\]](#)
- [Object description and parameterization \[► 457\]](#)

2.7.1.2 EL3172 - Technical data

Technical data		EL3172
Analog inputs		2
ADC type		SAR
Signal voltage		-10/0...+10 V
Signal current		-20/0/+4...+20 mA
Measuring range, nominal (Full Scale Value)	Voltage measurement range	-10/0...+10 V
	Current measurement range	-20/0/+4...+20 mA
Measuring range, technical	Voltage measurement range	-10.73...+10.73 V
	Current measurement range	-21.47...+21.47 mA
Measuring error (full measuring range)		< ±0.2 % (at 25 °C (±5 °C), or else < ±0.3 %, relative to full scale value)
Distributed Clocks		yes
Distributed Clocks precision		<< 1 µs
Support NoCoEStorage [▶ 142]		yes
Resolution		16 bit (incl. sign)
Sampling type		simultaneous
Ground reference		differential
Internal resistance		Voltage measurement: > 200 kΩ Current measurement: 85 Ω typ.
Input filter limit frequency		5 kHz
Common-mode voltage U _{CM}		-
Minimal EtherCAT cycle time		175 µs
Overcurrent protection		50 mA typ.
Bit width of the process image		Inputs: 16 Byte
Configuration		no address or configuration settings required
Special features		U/I parameterizable, Extended Range, standard and compact process image, activatable FIR/IIR filters
Supply voltage for electronic		via the E-bus
Current consumption via E-bus		typ. 140 mA
Electrical isolation		functional isolation (testing voltage 707 V, 7s channel/ channel and channel/ fieldbus, production test)
Recommended operating voltage range (ground related to GND/ 0V power contact)	Voltage measurement range	Depending on the normative application environment with consideration of the above stated electrical isolation
	Current measurement range	
Recommended signal range	Voltage measurement range	Extended Range (107%), differential
	Current measurement range	Extended Range (107%), differential
Destruction limit (ground related to GND/ 0V power contact)	Voltage measurement range	2.5 kV (Testing voltage production test)
	Current measurement range	2.5 kV (Testing voltage production test)
Destruction limit (differential)	Voltage measurement range	30 V (overcurrent protection available, see above)
	Current measurement range	30 V (overcurrent protection available, see above)
Weight		approx. 65 g
Permissible ambient temperature range during operation		-25...+60 °C
Permissible ambient temperature range during storage		-40...+85 °C
Permissible relative humidity		95 %, no condensation
Design		compact terminal housing with signal LED
Dimensions (W x H x D)		approx. 15 mm x 100 mm x 70 mm (width aligned: 12 mm)
Mounting [▶ 155]		on 35 mm mounting rail conforms to EN 60715
Vibration/shock resistance		conforms to EN 60068-2-6/EN 60068-2-27
EMC immunity/emission		conforms to EN 61000-6-2/EN 61000-6-4
Protection class		IP20
Installation position		variable
Marking / Approval		CE, EAC, UKCA

*) Real applicable approvals/markings see type plate on the side (product marking).

2.7.1.3 EL3172 - Connection, display and diagnostics

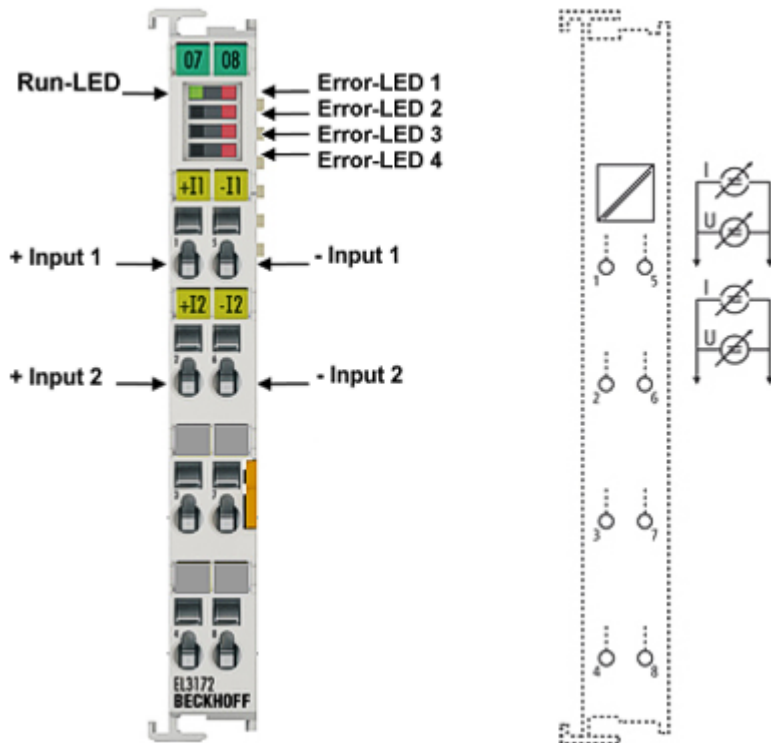

Fig. 47: EL3172 - LEDs and connection

Connection EL3172				
Terminal point		Description	Internally connected with connection	Max. current carrying capacity *)
Name	No.			
+ Input 1	1	Channel 1, voltage/current measurement (U/ I), positive input (+)	-	40 mA
+ Input 2	2	Channel 2, voltage/current measurement (U/ I), positive input (+)	-	40 mA
n.c	3	-	-	-
n.c	4	-	-	-
- Input 1	5	Channel 1, voltage/current measurement (U/ I), negative input (-)	-	40 mA
- Input 2	6	Channel 2, voltage/current measurement (U/ I), negative input (-)	-	40 mA
n.c	7	-	-	-
n.c	8	-	-	-

*) Constant and peak value

● Overcurrent protection of the 20 mA inputs

i The current inputs are protected against damage by overcurrent by an internal current limitation, currents > 30mA may occur. In the event of a fault, the current limiter must not be overloaded by a voltage > 30V from the source device.

Overcurrent is displayed in the process image as "Overrange". After occurrence, the error condition must be stopped immediately, the source device switched off or disconnected from the input terminal. If the error condition persists for a longer period of time, the internal terminal current limitation reduces the absorbed signal current for thermal reasons, depending on the ambient conditions also below 20 mA.

LEDs			
LED	Color	Meaning	
RUN*	green	This LED indicates the terminal's operating state *:	
		off	State of the EtherCAT State Machine [▶ 139]: INIT = initialization of the terminal or BOOTSTRAP = function for <u>firmware updates</u> [▶ 491] of the terminal
		flashing	State of the EtherCAT State Machine: PREOP = function for mailbox communication and different standard-settings set
		single flash	State of the EtherCAT State Machine: SAFEOP = verification of the <u>Sync Manager</u> [▶ 219] channels and the distributed clocks. Outputs remain in safe state
on	State of the EtherCAT State Machine: OP = normal operating state; mailbox and process data communication is possible		
ERROR**	red	Fault indication in the event of broken wire or undershooting or overshooting of the measuring range	
*) If several RUN LEDs are present, all of them have the same function.			
**) The error display shows the signal processing state for each channel.			

2.7.2 EL3174

2.7.2.1 EL3174 - Introduction

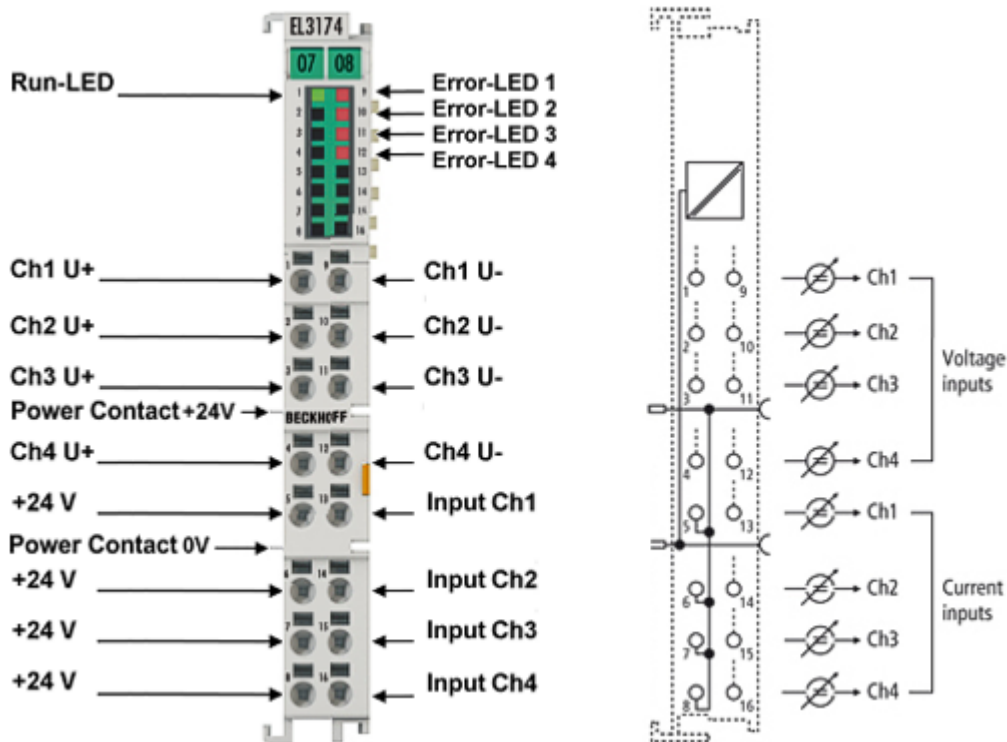

Fig. 48: EL3174

Analog Input Terminal; 4 channel, multi-function, ± 10 V, ± 20 mA, 16 bit

The EL3174 analog input terminal has four individually parameterizable inputs. Signals in the range from $-10/0$ to $+10$ V or $-20/0/+4$ to $+20$ mA can be processed via each channel. Physically, the voltage and current signals should be connected to different terminal points.

Each channel should then be set by the controller/TwinCAT to U or I mode via CoE. The voltage inputs operate differentially; the current inputs are single-ended. All inputs are digitized with a resolution of 16 bits and transmitted, electrically isolated, to the higher-level automation device.

With a technical measuring range of $\pm 107\%$ of the nominal range, the terminal also supports commissioning with sensor values in the limit range and diagnostics according to NAMUR NE43.

● 107% Extended Range

i The EL3174/ EL3174-00xx are preconfigured to a measurement range of 107% (e.g. 0x7FFF correspond to $+10.737$ V or 3.22 V accordingly). Via CoE access can be reset to the previously known legacy range. Then 0x7FFF correspond to the full scale value or e.g. 10 V (3 V) as before.

Quick-Links

- [EtherCAT basics](#)
- [Process data and operating modes \[► 244\]](#)
- [Object description and parameterization \[► 465\]](#)

2.7.2.2 EL3174 - Technical data

Technical data		EL3174
Analog inputs		4
ADC type		SAR
Signal voltage		-10/0...+10 V
Signal current		-20/0/+4...+20 mA
Measuring range, nominal (Full Scale Value)	Voltage measurement range	-10/0...+10 V
	Current measurement range	-20/0/+4...+20 mA
Measuring range, technical	Voltage measurement range	-10.73...+10.73 V
	Current measurement range	-21.47...+21.47 mA
Measuring error (full measuring range)		< ±0.3 % (relative to full scale value)
Distributed Clocks		yes
Distributed Clocks precision		<< 1 µs
Support NoCoEStorage [▶ 142]		yes
Resolution		16 bit (incl. sign)
Sampling type		multiplex
Ground reference		U differential, I single-ended
Internal resistance		Voltage measurement: > 200 kΩ Current measurement: 85 Ω typ.
Input filter limit frequency		5 kHz
Common-mode voltage U _{CM}		35 V max. (voltage measurement)
Minimal EtherCAT cycle time		200 µs
Overcurrent protection		50 mA typ.
Bit width of the process image		Inputs: 16 Byte
Configuration		no address or configuration settings required
Special features		U/I parameterizable, Extended Range, standard and compact process image, activatable FIR/IIR filters
Supply voltage for electronic		via the E-bus
Current consumption via E-bus		typ. 180 mA
Electrical isolation		500 V (E bus/ fieldbus voltage)
Recommended operating voltage range (ground related to GND/ 0V power contact)	Voltage measurement range	U _{CM} 35 V max.
	Current measurement range	single ended, dielectric strength max. 30 V
Recommended signal range	Voltage measurement range	Extended Range (107%), differential
	Current measurement range	Extended Range (107%), single ended
Destruction limit (ground related to GND/ 0V power contact)	Voltage measurement range	50 V
	Current measurement range	30 V
Destruction limit (differential)	Voltage measurement range	50 V
	Current measurement range	n.a.
Weight		approx. 65 g
Permissible ambient temperature range during operation		-25...+60 °C
Permissible ambient temperature range during storage		-40...+85 °C
Permissible relative humidity		95 %, no condensation
Design		HD (High Density) housing with signal LED
Dimensions (W x H x D)		approx. 15 mm x 100 mm x 70 mm (width aligned: 12 mm)
Mounting [▶ 155]		on 35 mm mounting rail conforms to EN 60715
Vibration/shock resistance		conforms to EN 60068-2-6/EN 60068-2-27
EMC immunity/emission		conforms to EN 61000-6-2/EN 61000-6-4
Protection class		IP20
Installation position		variable
Marking / Approval		CE, EAC, UKCA ATEX [▶ 149], IECEx [▶ 150], cFMus [▶ 152] cULus [▶ 154]

*) Real applicable approvals/markings see type plate on the side (product marking).

Ex markings

Standard	Marking
ATEX	II 3 G Ex nA IIC T4 Gc
IECEX	Ex nA IIC T4 Gc
cFMus	Class I, Division 2, Groups A, B, C, D Class I, Zone 2, AEx/Ex ec IIC T4 Gc

2.7.2.3 EL3174 - Connection, display and diagnostics

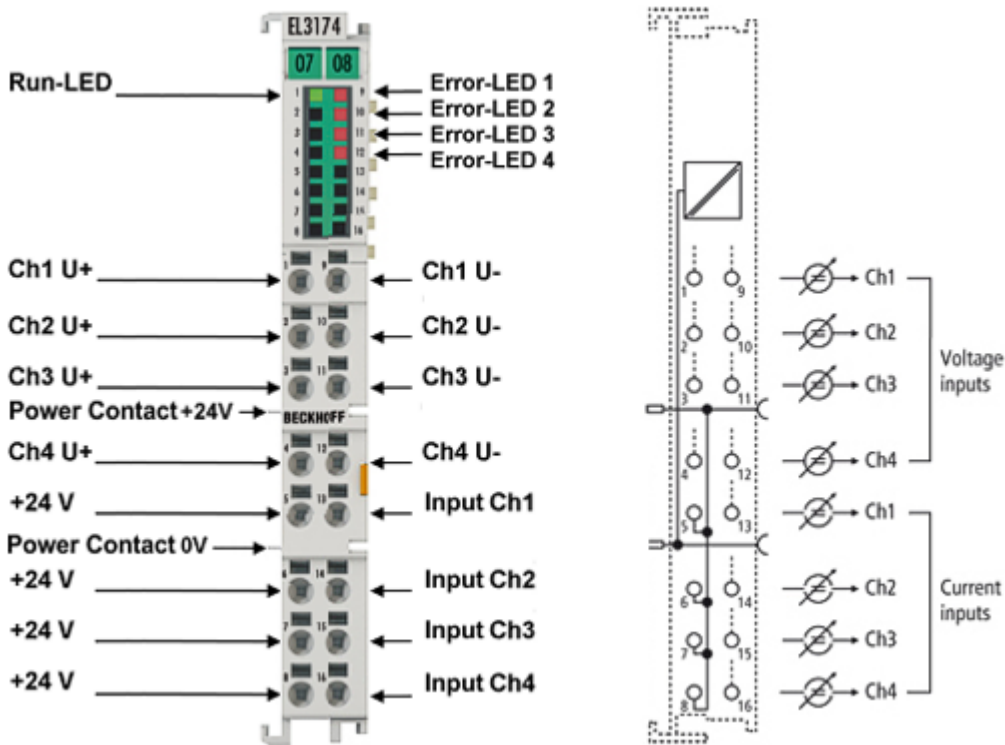

Fig. 49: EL3174 - LEDs and Connection

Connection EL3174				
Terminal point		Description	Internally connected with connection	Max. current carrying capacity *)
Name	No.			
Ch1 U+	1	Channel 1, voltage measurement, positive input (U+)	-	not applicable (voltage input)
Ch2 U+	2	Channel 2, voltage measurement, positive input (U+)	-	not applicable (voltage input)
Ch3 U+	3	Channel 3, voltage measurement, positive input (U+)	-	not applicable (voltage input)
Ch4 U+	4	Channel 4, voltage measurement, positive input (U+)	-	not applicable (voltage input)
+24 V	5, 6, 7, 8	+24 V	positive power contact	1 A
Ch1 U-	9	Channel 1, voltage measurement, negative input (U-)	-	not applicable (voltage input)
Ch2 U-	10	Channel 2, voltage measurement, negative input (U-)	-	not applicable (voltage input)
Ch3 U-	11	Channel 3, voltage measurement, negative input (U-)	-	not applicable (voltage input)
Ch4 U-	12	Channel 4, voltage measurement, negative input (U-)	-	not applicable (voltage input)
Input Ch1	13	Channel 1, current measurement, input (I)	-	40 mA
Input Ch2	14	Channel 2, current measurement, input (I)	-	40 mA
Input Ch3	15	Channel 3, current measurement, input (I)	-	40 mA
Input Ch4	16	Channel 4, current measurement, input (I)	-	40 mA
Ch1 U+	1	Channel 1, voltage measurement, positive input (U+)	-	not applicable (voltage input)
Ch2 U+	2	Channel 2, voltage measurement, positive input (U+)	-	not applicable (voltage input)
Ch3 U+	3	Channel 3, voltage measurement, positive input (U+)	-	not applicable (voltage input)

*) Constant and peak value

● **Overcurrent protection of the 20 mA inputs**

I The current inputs are protected against damage by overcurrent by an internal current limitation, currents > 30mA may occur. In the event of a fault, the current limiter must not be overloaded by a voltage > 30V from the source device.

Overcurrent is displayed in the process image as "Overrange". After occurrence, the error condition must be stopped immediately, the source device switched off or disconnected from the input terminal. If the error condition persists for a longer period of time, the internal terminal current limitation reduces the absorbed signal current for thermal reasons, depending on the ambient conditions also below 20 mA.

LEDs			
LED	Color	Meaning	
RUN*	green	This LED indicates the terminal's operating state *:	
		off	State of the EtherCAT State Machine [▶ 139] : INIT = initialization of the terminal or BOOTSTRAP = function for firmware updates [▶ 491] of the terminal
		flashing	State of the EtherCAT State Machine: PREOP = function for mailbox communication and different standard-settings set
		single flash	State of the EtherCAT State Machine: SAFEOP = verification of the Sync Manager [▶ 219] channels and the distributed clocks. Outputs remain in safe state
		on	State of the EtherCAT State Machine: OP = normal operating state; mailbox and process data communication is possible
ERROR**	red	Fault indication in the event of broken wire or undershooting or overshooting of the measuring range	

*) If several RUN LEDs are present, all of them have the same function.

***) The error display shows the signal processing state for each channel.

2.7.3 EL3174-0002

2.7.3.1 EL3174-0002 - Introduction

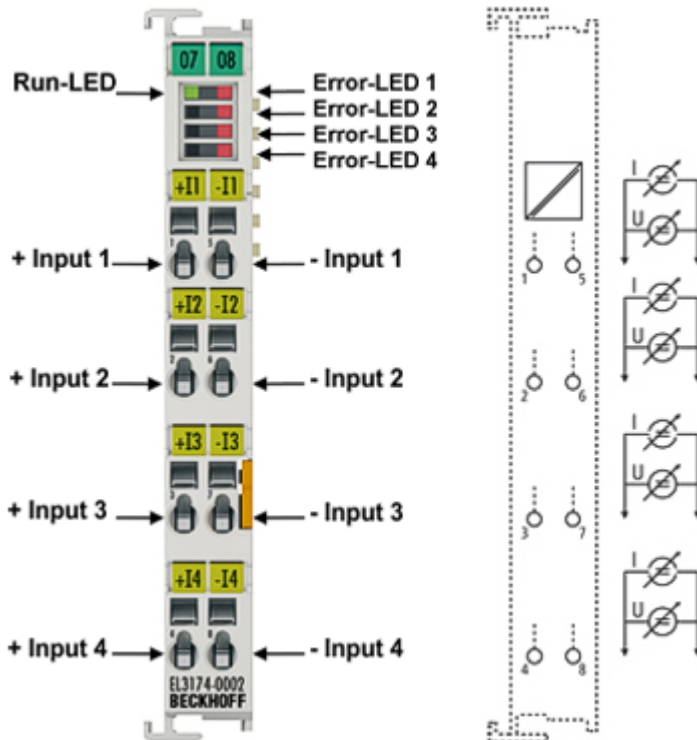

Fig. 50: EL3174-0002

Analog Input Terminal; 4 channel, multi-function, ± 10 V, ± 20 mA, 16 bit, differential, electrically isolated

The EL3174-0002 analog input terminal has four individually parameterizable inputs. Signals in the range from -10/0 to +10 V or -20/0/+4 to +20 mA can be processed via each channel.

Each channel should be set by the controller to U or I mode via CoE. The input voltage or current is digitized with a resolution of 16 bits, and is transmitted, electrically isolated, to the higher-level automation device.

With a technical measuring range of $\pm 107\%$ of the nominal range, the terminal also supports commissioning with sensor values in the limit range and diagnostics according to NAMUR NE43. The four differential inputs are electrically isolated against each other and against the fieldbus (2,500 V DC)..

● 107% Extended Range

i The EL3174/ EL3174-00xx are preconfigured to a measurement range of 107% (e.g. 0x7FFF correspond to +10.737 V or 3.22 V accordingly). Via CoE access can be reset to the previously known legacy range. Then 0x7FFF correspond to the full scale value or e.g. 10 V (3 V) as before.

Quick-Links

- [EtherCAT basics](#)
- [Process data and operating modes \[▶ 244\]](#)
- [Object description and parameterization \[▶ 465\]](#)

2.7.3.2 EL3174-0002 - Technical data

Technical data		EL3174-0002
Analog inputs		4
ADC type		SAR
Signal voltage		-10/0...+10 V
Signal current		-20/0/+4...+20 mA
Measuring range, nominal (Full Scale Value)	Voltage measurement range	-10/0...+10 V
	Current measurement range	-20/0/+4...+20 mA
Measuring range, technical	Voltage measurement range	-10.73...+10.73 V
	Current measurement range	-21.47...+21.47 mA
Measuring error (full measuring range)		< ±0.2 % (at 25 °C (±5 °C), or else < ±0.3 %, relative to full scale value)
Distributed Clocks		yes
Distributed Clocks precision		<< 1 µs
Support NoCoEStorage [▶ 142]		yes
Resolution		16 bit (incl. sign)
Sampling type		simultaneous
Ground reference		differential
Internal resistance		Voltage measurement: > 200 kΩ Current measurement: 85 Ω typ.
Input filter limit frequency		5 kHz
Common-mode voltage U _{CM}		-
Minimal EtherCAT cycle time		175 µs
Overcurrent protection		50 mA typ.
Bit width of the process image		Inputs: 16 Byte
Configuration		no address or configuration settings required
Special features		U/I parameterizable, Extended Range, standard and compact process image, activatable FIR/IIR filters
Supply voltage for electronic		via the E-bus
Current consumption via E-bus		typ. 140 mA
Electrical isolation		functional isolation (testing voltage 2,500 V, 7s channel/ channel and channel/ fieldbus, production test)
Recommended operating voltage range (ground related to GND/ 0V power contact)	Voltage measurement range	Depending on the normative application environment with consideration of the above stated electrical isolation
	Current measurement range	
Recommended signal range	Voltage measurement range	Extended Range (107%), differential
	Current measurement range	Extended Range (107%), differential
Destruction limit (ground related to GND/ 0V power contact)	Voltage measurement range	2.5 kV (Testing voltage production test)
	Current measurement range	2.5 kV (Testing voltage production test)
Destruction limit (differential)	Voltage measurement range	30 V (overcurrent protection available, see above)
	Current measurement range	30 V (overcurrent protection available, see above)
Weight		approx. 65 g
Permissible ambient temperature range during operation		-25...+60 °C
Permissible ambient temperature range during storage		-40...+85 °C
Permissible relative humidity		95 %, no condensation
Design		compact terminal housing with signal LED
Dimensions (W x H x D)		approx. 15 mm x 100 mm x 70 mm (width aligned: 12 mm)
Mounting [▶ 155]		on 35 mm mounting rail conforms to EN 60715
Vibration/shock resistance		conforms to EN 60068-2-6/EN 60068-2-27
EMC immunity/emission		conforms to EN 61000-6-2/EN 61000-6-4
Protection class		IP20
Installation position		variable
Marking / Approval ¹⁾		CE, EAC, UKCA ATEX [▶ 149], IECEx [▶ 150], cFMus [▶ 152] cULus [▶ 154]

*) Real applicable approvals/markings see type plate on the side (product marking).

Ex markings

Standard	Marking
ATEX	II 3 G Ex nA IIC T4 Gc
IECEX	Ex nA IIC T4 Gc
cFMus	Class I, Division 2, Groups A, B, C, D Class I, Zone 2, AEx/Ex ec IIC T4 Gc

2.7.3.3 EL3174-0002 - Connection, display and diagnostics

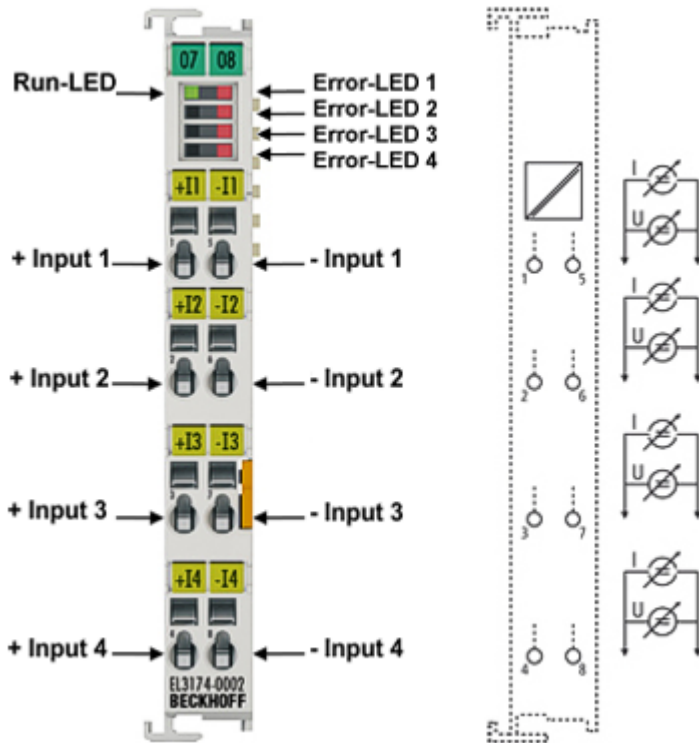

Fig. 51: EL3174-0002 - LEDs and Connection

Connection EL3174-0002				
Terminal point		Description	Internally connected with connection	Max. current carrying capacity *)
Designation	No.			
+ Input 1	1	Channel 1, voltage/current measurement (U/ I), positive input (+)	-	40 mA
+ Input 2	2	Channel 2, voltage/current measurement (U/ I), positive input (+)	-	40 mA
+ Input 3	3	Channel 3, voltage/current measurement (U/ I), positive input (+)	-	40 mA
+ Input 4	4	Channel 4, voltage/current measurement (U/ I), positive input (+)	-	40 mA
- Input 1	5	Channel 1, voltage/current measurement (U/ I), negative input (-)	-	40 mA
- Input 2	6	Channel 2, voltage/current measurement (U/ I), negative input (-)	-	40 mA
- Input 3	7	Channel 3, voltage/current measurement (U/ I), negative input (-)	-	40 mA
- Input 4	8	Channel 4, voltage/current measurement (U/ I), negative input (-)	-	40 mA

*) Constant and peak value

i Overcurrent protection of the 20 mA inputs

The current inputs are protected against damage by overcurrent by an internal current limitation, currents > 30mA may occur. In the event of a fault, the current limiter must not be overloaded by a voltage > 30V from the source device.

Overcurrent is displayed in the process image as "Overrange". After occurrence, the error condition must be stopped immediately, the source device switched off or disconnected from the input terminal. If the error condition persists for a longer period of time, the internal terminal current limitation reduces the absorbed signal current for thermal reasons, depending on the ambient conditions also below 20 mA.

LEDs			
LED	Color	Meaning	
RUN*	green	This LED indicates the terminal's operating state *:	
		off	State of the EtherCAT State Machine [▶ 139]: INIT = initialization of the terminal or BOOTSTRAP = function for <u>firmware updates</u> [▶ 491] of the terminal
		flashing	State of the EtherCAT State Machine: PREOP = function for mailbox communication and different standard-settings set
		single flash	State of the EtherCAT State Machine: SAFEOP = verification of the <u>Sync Manager</u> [▶ 219] channels and the distributed clocks. Outputs remain in safe state
		on	State of the EtherCAT State Machine: OP = normal operating state; mailbox and process data communication is possible
ERROR**	red	Fault indication in the event of broken wire or undershooting or overshooting of the measuring range	
*) If several RUN LEDs are present, all of them have the same function.			
**) The error display shows the signal processing state for each channel.			

2.7.4 EL3174-0030

2.7.4.1 EL3174-0030 - Introduction

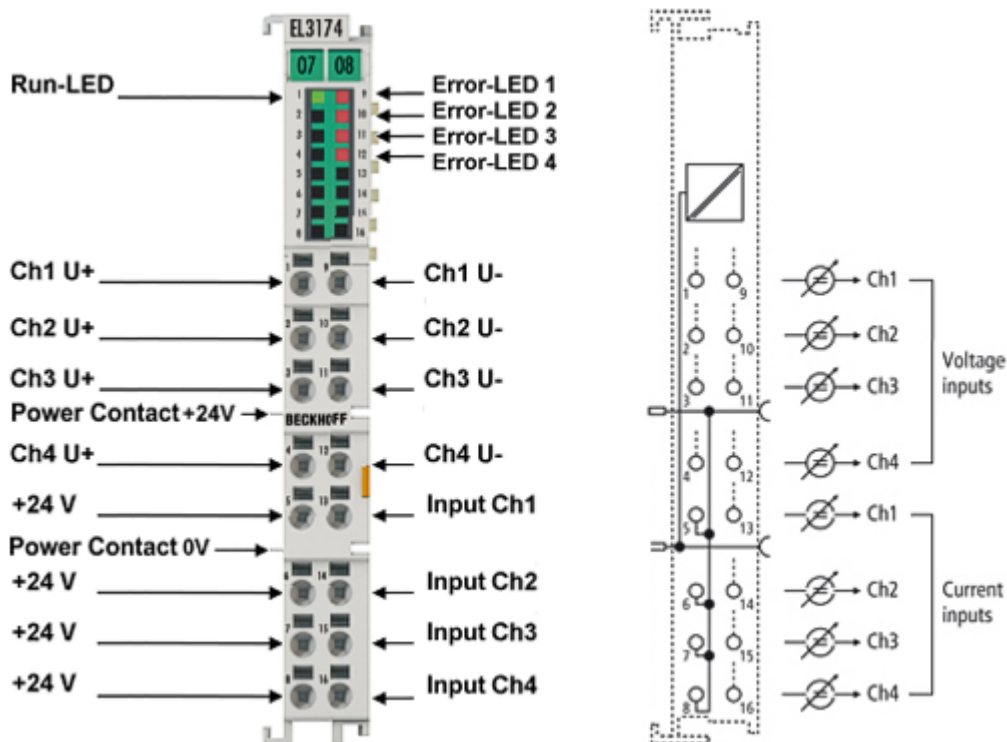

Fig. 52: EL3174-0030

Analog Input Terminal; 4 channel, multi-function, ± 10 V, ± 20 mA, 16 bit, externally calibrated

The EL3174-0030 analog input terminal has four individually parameterizable inputs. Signals in the range from -10/0 to +10 V or -20/0/+4 to +20 mA can be processed via each channel. Physically, the voltage and current signals should be connected to different terminal points. Each channel should then be set by the controller/TwinCAT to U or I mode via CoE. The voltage inputs operate differentially; the current inputs are single-ended. All inputs are digitized with a resolution of 16 bits and transmitted, electrically isolated, to the higher-level automation device. With a technical measuring range of ± 107 % of the nominal range, the terminal also supports commissioning with sensor values in the limit range and diagnostics according to NAMUR NE43.

For the EL3174-0030, an individual calibration certificate is available, currently as a choice of DAkkS or ISO 17025-compliant certificate. The certificate is issued by an accredited service provider in collaboration with Beckhoff.

The desired calibration certificate can be downloaded from [here](#) using the respective serial number.

i 107% Extended Range

The EL3174/ EL3174-00xx are preconfigured to a measurement range of 107% (e.g. 0x7FFF correspond to +10.737 V or 3.22 V accordingly). Via CoE access can be reset to the previously known legacy range. Then 0x7FFF correspond to the full scale value or e.g. 10 V (3 V) as before.

Quick-Links

- [EtherCAT basics](#)
- [Process data and operating modes \[► 244\]](#)
- [Object description and parameterization \[► 465\]](#)

2.7.4.2 EL3174-0030 - Technical data

Technical data		EL3174-0030
Analog inputs		4
ADC type		SAR
Signal voltage		-10/0...+10 V
Signal current		-20/0/+4...+20 mA
Measuring range, nominal (Full Scale Value)	Voltage measurement range	-10/0...+10 V
	Current measurement range	-20/0/+4...+20 mA
Measuring range, technical	Voltage measurement range	-10.73...+10.73 V
	Current measurement range	-21.47...+21.47 mA
Measuring error (full measuring range)		< ±0.3 % (relative to full scale value)
Calibration certificate [► 118] (analog)		externally calibrated
Distributed Clocks		yes
Distributed Clocks precision		<< 1 µs
Support NoCoEStorage [► 142]		yes
Resolution		16 bit (incl. sign)
Sampling type		multiplex
Ground reference		U differential, I single-ended
Internal resistance		Voltage measurement: > 200 kΩ Current measurement: 85 Ω typ.
Input filter limit frequency		5 kHz
Common-mode voltage U_{CM}		35 V max. (voltage measurement)
Minimal EtherCAT cycle time		200 µs
Overcurrent protection		50 mA typ.
Bit width of the process image		Inputs: 16 Byte
Configuration		no address or configuration settings required
Special features		U/I parameterizable, Extended Range, standard and compact process image, activatable FIR/IIR filters EL3174-0090 with TwinSAFE SC technology
Supply voltage for electronic		via the E-bus
Current consumption via E-bus		typ. 170 mA
Electrical isolation		500 V (E bus/ fieldbus voltage)
Recommended operating voltage range (ground related to GND/ 0V power contact)	Voltage measurement range	U_{CM} 35 V max.
	Current measurement range	single ended, dielectric strength max. 30 V
Recommended signal range	Voltage measurement range	Extended Range (107%), differential
	Current measurement range	Extended Range (107%), single ended
Destruction limit (ground related to GND/ 0V power contact)	Voltage measurement range	50 V
	Current measurement range	30 V
Destruction limit (differential)	Voltage measurement range	50 V
	Current measurement range	n.a.
Weight		approx. 65 g
Permissible ambient temperature range during operation		-25...+60 °C
Permissible ambient temperature range during storage		-40...+85 °C
Permissible relative humidity		95 %, no condensation
Design		HD (High Density) housing with signal LED
Dimensions (W x H x D)		approx. 15 mm x 100 mm x 70 mm (width aligned: 12 mm)
Mounting [► 155]		on 35 mm mounting rail conforms to EN 60715
Vibration/shock resistance		conforms to EN 60068-2-6/EN 60068-2-27
EMC immunity/emission		conforms to EN 61000-6-2/EN 61000-6-4
Protection class		IP20
Installation position		variable
Marking / Approval ^{*)}		CE, EAC, UKCA cULus [► 154]

*) Real applicable approvals/markings see type plate on the side (product marking).

2.7.4.3 EL3174-0030 - Connection, display and diagnostics

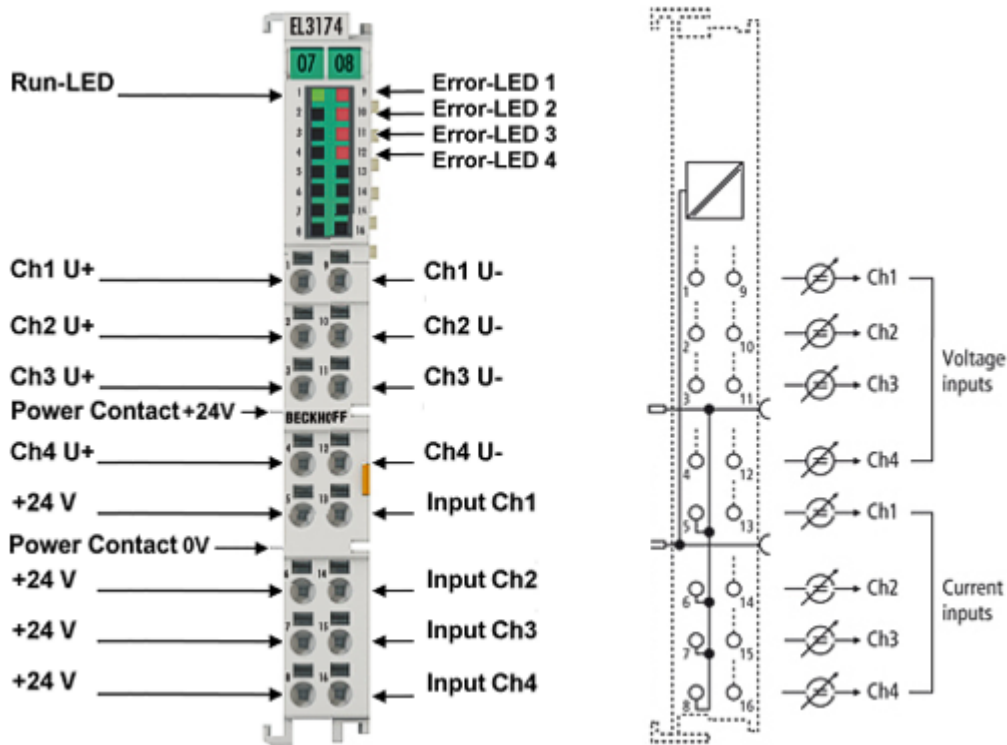

Fig. 53: EL3174-0030 - LEDs and Connection

Connection EL3174-0030				
Terminal point		Description	Internally connected with connection	Max. current carrying capacity *)
Name	No.			
Ch1 U+	1	Channel 1, voltage measurement, positive input (U+)	-	not applicable (voltage input)
Ch2 U+	2	Channel 2, voltage measurement, positive input (U+)	-	not applicable (voltage input)
Ch3 U+	3	Channel 3, voltage measurement, positive input (U+)	-	not applicable (voltage input)
Ch4 U+	4	Channel 4, voltage measurement, positive input (U+)	-	not applicable (voltage input)
+24 V	5, 6, 7, 8	+24 V	positive power contact	1 A
Ch1 U-	9	Channel 1, voltage measurement, negative input (U-)	-	not applicable (voltage input)
Ch2 U-	10	Channel 2, voltage measurement, negative input (U-)	-	not applicable (voltage input)
Ch3 U-	11	Channel 3, voltage measurement, negative input (U-)	-	not applicable (voltage input)
Ch4 U-	12	Channel 4, voltage measurement, negative input (U-)	-	not applicable (voltage input)
Input Ch1	13	Channel 1, current measurement, input (I)	-	40 mA
Input Ch2	14	Channel 2, current measurement, input (I)	-	40 mA
Input Ch3	15	Channel 3, current measurement, input (I)	-	40 mA
Input Ch4	16	Channel 4, current measurement, input (I)	-	40 mA
Ch1 U+	1	Channel 1, voltage measurement, positive input (U+)	-	not applicable (voltage input)
Ch2 U+	2	Channel 2, voltage measurement, positive input (U+)	-	not applicable (voltage input)
Ch3 U+	3	Channel 3, voltage measurement, positive input (U+)	-	not applicable (voltage input)

*) Constant and peak value

● Overcurrent protection of the 20 mA inputs

i The current inputs are protected against damage by overcurrent by an internal current limitation, currents > 30mA may occur. In the event of a fault, the current limiter must not be overloaded by a voltage > 30V from the source device.

Overcurrent is displayed in the process image as "Overrange". After occurrence, the error condition must be stopped immediately, the source device switched off or disconnected from the input terminal. If the error condition persists for a longer period of time, the internal terminal current limitation reduces the absorbed signal current for thermal reasons, depending on the ambient conditions also below 20 mA.

LEDs			
LED	Color	Meaning	
RUN*	green	This LED indicates the terminal's operating state *:	
		off	State of the EtherCAT State Machine [▶ 139] : INIT = initialization of the terminal or BOOTSTRAP = function for firmware updates [▶ 491] of the terminal
		flashing	State of the EtherCAT State Machine: PREOP = function for mailbox communication and different standard-settings set
		single flash	State of the EtherCAT State Machine: SAFEOP = verification of the Sync Manager [▶ 219] channels and the distributed clocks. Outputs remain in safe state
		on	State of the EtherCAT State Machine: OP = normal operating state; mailbox and process data communication is possible
ERROR**	red	Fault indication in the event of broken wire or undershooting or overshooting of the measuring range	

*) If several RUN LEDs are present, all of them have the same function.
 **) The error display shows the signal processing state for each channel.

2.7.4.4 Note on Beckhoff calibration certificates

Basically every Beckhoff analogue device (input or output) will be justified i.e. will be calibrated during production. This procedure won't be documented unique. This documentation as a calibration certificate is only provided for devices that are expressly delivered with a certificate.

The calibration certificate (or German: "Kalibrierschein") entitles the residual error after compensation/adjustment to the used standard (reference device). The calibration certificate (as a PDF document) is to be assigned to the device via a unique number. It is therefore not a statement about a device class such as e.g. an approval, but always only applies to a single, named device. It is available for [download](#).

The calibration certificate documents the measurement accuracy at the time the certificate was issued and contains, among other things, information on the ambient conditions and the reference instrument used. It does not contain statement about the behavior or the change of the measuring accuracy in the future. A calibration certificate acts as a backtracking view to the previous time of usage. By reiterated certification procedures over years (without justification) it allows making conclusions about its ageing behavior, so called calibrate history.

Performance levels of the calibration certificates

Different "qualities" of a calibration certificate are common:

- Beckhoff calibration certificates
Such IP20 terminals can be usually identified by the product suffix -0020. The certificate is issued in Beckhoff production as PDF.
The terminals can be obtained from Beckhoff and recalibrated by the Beckhoff service department.
- ISO17025 calibration certificates
Such IP20 terminals can be usually identified by the product suffix -0030. The certificate is issued by a service provider on behalf of Beckhoff as part of Beckhoff production and delivered by Beckhoff as a PDF.
The terminals can be obtained from Beckhoff and recalibrated by the Beckhoff service department.
- DAkkS calibration certificates (German: "Deutsche Akkreditierungsstelle GmbH")
Such IP20 terminals can be usually identified by the product suffix -0030. The certificate is issued by a accredited service provider on behalf of Beckhoff as a part of Beckhoff production and delivered by Beckhoff as a PDF.
The terminals can be obtained from Beckhoff and recalibrated by the Beckhoff service department.

Unique device number

Depending on the device, the following numbers are used for identification:

- EL/ELM terminals up to year of manufacture 2020: the ID number which is lasered on the side.



Fig. 54: ID number

- From year of manufacture 2021 onwards, the BTN number (Beckhoff Traceability Number) will gradually replace the ID number, this is also lasered on the side.

Beckhoff produces a wide range of analog input/output devices as IP20 terminal or IP67 box. A selection of these is also available with factory/ISO/DakkS calibration certificates. For specific details and availability, see the technical data of the devices or contact Beckhoff Sales.

i Linguistic note

In American English, "calibration" or "alignment" is understood to mean compensation/adjustment, thus a modifying effect on the device. "Verification", on the other hand, refers to observational determination and documentation of the residual error, referred in German language use as "*Kalibrierung*".

2.7.5 EL3174-0032

2.7.5.1 EL3174-0032 - Introduction

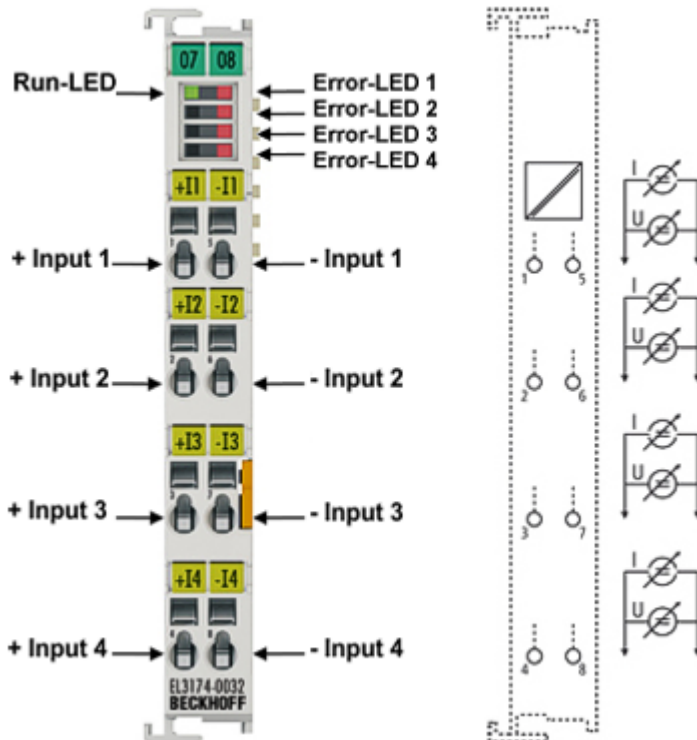

Fig. 55: EL3174-0032

Analog Input Terminal; 4 channel, multi-function, ± 3 V, ± 20 mA, 16 bit, differential

The EL3174-0032 analog input terminal has four individually parameterizable inputs. Signals in the range from $-3 \dots +3$ V or from $-20/0/+4 \dots +20$ mA can be processed by each channel. Each channel should be set via the controller to U or I mode via CoE.

The input voltage or current is digitized with a resolution of 16 bit, and is transmitted electrically isolated to the higher-level automation device. With a technical measuring range of 107 % of the nominal range, the terminal also supports commissioning with sensor values in the limit range and an evaluation according to NAMUR NE43.

The four differential inputs are electrically isolated against each other and against the fieldbus (2500 V DC).

● 107% Extended Range

i The EL3174/ EL3174-00xx are preconfigured to a measurement range of 107% (e.g. 0x7FFF correspond to +10.737 V or 3.22 V accordingly). Via CoE access can be reset to the previously known legacy range. Then 0x7FFF correspond to the full scale value or e.g. 10 V (3 V) as before.

Quick-Links

- [EtherCAT basics](#)
- [Process data and operating modes \[► 244\]](#)
- [Object description and parameterization \[► 465\]](#)

2.7.5.2 EL3174-0032 - Technical data

Technical data		EL3174-0032
Analog inputs		4
Conversion type		simultaneous
ADC type		SAR
Signal voltage		-3/0...+3 V
Signal current		-20/0/+4...+20 mA
Measuring range, nominal (Full Scale Value)	Voltage measurement range	-3/0...+3 V
	Current measurement range	-20/0/+4...+20 mA
Measuring range, technical	Voltage measurement range	-3.22...+3.22 V
	Current measurement range	-21.47...+21.47 mA
Measuring error (full measuring range)		< ±0.2 % (at 25 °C (±5 °C), or else < ±0.3 %, relative to full scale value)
Distributed Clocks		yes
Distributed Clocks precision		<< 1 µs
Support NoCoEStorage [▶ 142]		yes
Resolution		16 bit (incl. sign)
Sampling type		simultaneous
Ground reference		differential
Internal resistance		Voltage measurement: > 200 kΩ Current measurement: 85 Ω typ.
Input filter limit frequency		5 kHz
Common-mode voltage U _{CM}		-
Minimal EtherCAT cycle time		175 µs
Overcurrent protection		50 mA typ.
Bit width of the process image		Inputs: 16 Byte
Configuration		no address or configuration settings required
Special features		U/I parameterizable, Extended Range, standard and compact process image, activatable FIR/IIR filters
Supply voltage for electronic		via the E-bus
Current consumption via E-bus		typ. 140 mA
Electrical isolation		functional isolation (testing voltage 2,500 V, 7s channel/ channel and channel/ fieldbus, production test)
Recommended operating voltage range (ground related to GND/ 0V power contact)	Voltage measurement range	Depending on the normative application environment with consideration of the above stated electrical isolation
	Current measurement range	
Recommended signal range	Voltage measurement range	Extended Range (107%), differential
	Current measurement range	Extended Range (107%), differential
Destruction limit (ground related to GND/ 0V power contact)	Voltage measurement range	2.5 kV (Testing voltage production test)
	Current measurement range	2.5 kV (Testing voltage production test)
Destruction limit (differential)	Voltage measurement range	30 V (overcurrent protection available, see above)
	Current measurement range	30 V (overcurrent protection available, see above)
Weight		approx. 65 g
Permissible ambient temperature range during operation		-25...+60 °C
Permissible ambient temperature range during storage		-40...+85 °C
Permissible relative humidity		95 %, no condensation
Design		compact terminal housing with signal LED
Dimensions (W x H x D)		approx. 15 mm x 100 mm x 70 mm (width aligned: 12 mm)
Mounting [▶ 155]		on 35 mm mounting rail conforms to EN 60715
Vibration/shock resistance		conforms to EN 60068-2-6/EN 60068-2-27
EMC immunity/emission		conforms to EN 61000-6-2/EN 61000-6-4
Protection class		IP20
Installation position		variable
Marking / Approval ¹⁾		CE, EAC, UKCA ATEX [▶ 149], IECEx [▶ 150], cFMus [▶ 152] cULus [▶ 154]

*) Real applicable approvals/markings see type plate on the side (product marking).

Ex markings

Standard	Marking
ATEX	II 3 G Ex nA IIC T4 Gc
IECEX	Ex nA IIC T4 Gc
cFMus	Class I, Division 2, Groups A, B, C, D Class I, Zone 2, AEx/Ex ec IIC T4 Gc

2.7.5.3 EL3174-0032 - Connection, display and diagnostics

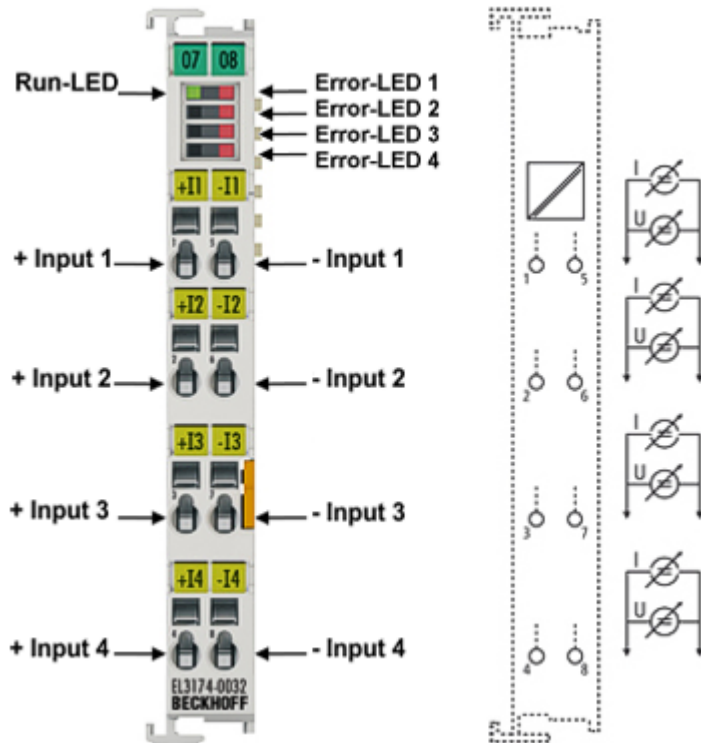

Fig. 56: EL3174-0032 - LEDs and connection

Connection EL3174-0032				
Terminal point		Description	Internally connected with connection	Max. current carrying capacity *)
Designation	No.			
+ Input 1	1	Channel 1, voltage/current measurement (U/ I), positive input (+)	-	40 mA
+ Input 2	2	Channel 2, voltage/current measurement (U/ I), positive input (+)	-	40 mA
+ Input 3	3	Channel 3, voltage/current measurement (U/ I), positive input (+)	-	40 mA
+ Input 4	4	Channel 4, voltage/current measurement (U/ I), positive input (+)	-	40 mA
- Input 1	5	Channel 1, voltage/current measurement (U/ I), negative input (-)	-	40 mA
- Input 2	6	Channel 2, voltage/current measurement (U/ I), negative input (-)	-	40 mA
- Input 3	7	Channel 3, voltage/current measurement (U/ I), negative input (-)	-	40 mA
- Input 4	8	Channel 4, voltage/current measurement (U/ I), negative input (-)	-	40 mA

*) Constant and peak value

i Overcurrent protection of the 20 mA inputs

The current inputs are protected against damage by overcurrent by an internal current limitation, currents > 30mA may occur. In the event of a fault, the current limiter must not be overloaded by a voltage > 30V from the source device.

Overcurrent is displayed in the process image as "Overrange". After occurrence, the error condition must be stopped immediately, the source device switched off or disconnected from the input terminal. If the error condition persists for a longer period of time, the internal terminal current limitation reduces the absorbed signal current for thermal reasons, depending on the ambient conditions also below 20 mA.

LEDs			
LED	Color	Meaning	
RUN*	green	This LED indicates the terminal's operating state *:	
		off	State of the <u>EtherCAT State Machine</u> [▶ 139]: INIT = initialization of the terminal or BOOTSTRAP = function for <u>firmware updates</u> [▶ 491] of the terminal
		flashing	State of the EtherCAT State Machine: PREOP = function for mailbox communication and different standard-settings set
		single flash	State of the EtherCAT State Machine: SAFEOP = verification of the <u>Sync Manager</u> [▶ 219] channels and the distributed clocks. Outputs remain in safe state
		on	State of the EtherCAT State Machine: OP = normal operating state; mailbox and process data communication is possible
ERROR**	red	Fault indication in the event of broken wire or undershooting or overshooting of the measuring range	
*) If several RUN LEDs are present, all of them have the same function.			
**) The error display shows the signal processing state for each channel.			

2.7.6 EL3174-0042

2.7.6.1 EL3174-0042 - Introduction

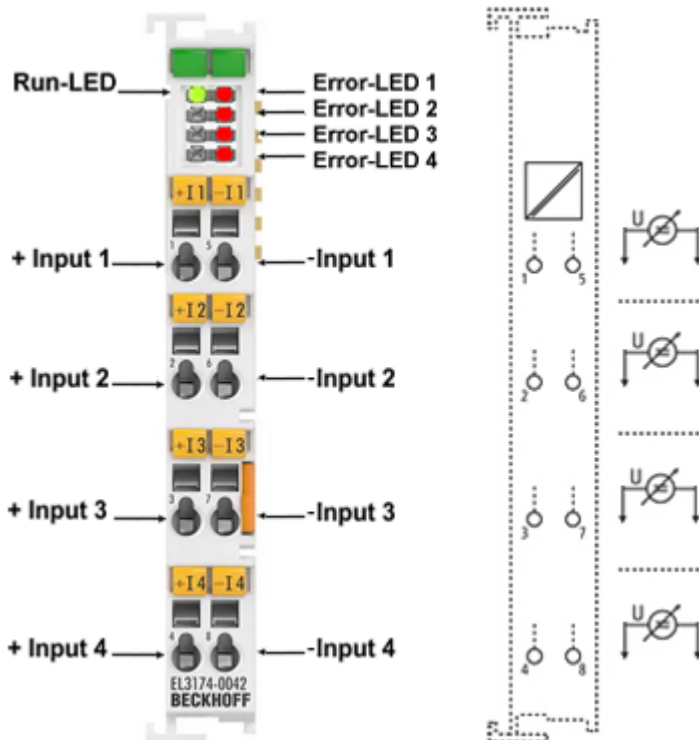

Fig. 57: EL3174-0042

Analog Input Terminal; 4 channel, multi-function, ± 60 V, ± 30 V, 16 bit, differential

The EL3174-0042 analog input terminal has four individually parameterizable inputs. Signals in the range from -60 to +60 V or -30 to +30 V can be processed via each channel. Each channel should be set via the controller to the respective measuring range via CoE.

The input voltage or current is digitized with a resolution of 16 bit, and is transmitted electrically isolated to the higher-level automation device. With a technical measuring range of 107 % of the nominal range, the terminal also supports commissioning with sensor values in the limit range.

The four differential inputs are electrically isolated against each other and against the fieldbus (2500 V DC)..

● 107% Extended Range

i The EL3174/ EL3174-00xx are preconfigured to a measurement range of 107% (e.g. 0x7FFF correspond to +10.737 V or 3.22 V accordingly). Via CoE access can be reset to the previously known legacy range. Then 0x7FFF correspond to the full scale value or e.g. 10 V (3 V) as before.

Quick-Links

- [EtherCAT basics](#)
- [Process data and operating modes \[▶ 244\]](#)
- [Object description and parameterization \[▶ 465\]](#)

2.7.6.2 EL3174-0042 - Technical data

Technical data	EL3174-0042
Analog inputs	4
ADC type	SAR
Measuring range, nominal (Full Scale Value)	-60...+60 V -30...+30 V
Measuring range, technical	-64.41...+64.41 V -32.21...+32.21 V
Measuring error (full measuring range)	< ±0.2 % (at 25 °C (±5 °C), or else < ±0.3 %, relative to full scale value)
Distributed Clocks	yes
Distributed Clocks precision	<< 1 µs
Support NoCoEStorage [▶ 142]	yes
Resolution	16 bit (incl. sign)
Sampling type	simultaneous
Ground reference	differential
Internal resistance	: > 200 kΩ
Input filter limit frequency	5 kHz
Common-mode voltage U _{CM}	-
Minimal conversion time	150 µs
Overcurrent protection	50 mA typ.
Bit width of the process image	Inputs: 16 Byte
Configuration	no address or configuration settings required
Special features	Measuring range parameterizable, extended range 107% preset, standard and compact process image, activatable FIR/IIR filters
Supply voltage for electronic	via the E-bus
Current consumption via E-bus	typ. 150 mA
Electrical isolation	functional isolation (testing voltage 2,500 V, 7s channel/ channel and channel/ fieldbus, production test)
Recommended operating voltage range (ground related to GND/ 0V power contact)	Depending on the normative application environment with consideration of the above stated electrical isolation
Recommended signal range	Extended Range (107%), differential
Destruction limit (ground related to GND/ 0V power contact)	2.5 kV (Testing voltage production test)
Destruction limit (differential)	100 V (overcurrent protection available, see above)
Weight	approx. 65 g
Permissible ambient temperature range during operation	-25...+60 °C
Permissible ambient temperature range during storage	-40...+85 °C
Permissible relative humidity	95 %, no condensation
Design	compact terminal housing with signal LED
Dimensions (W x H x D)	approx. 15 mm x 100 mm x 70 mm (width aligned: 12 mm)
Mounting [▶ 155]	on 35 mm mounting rail conforms to EN 60715
Vibration/shock resistance	conforms to EN 60068-2-6/EN 60068-2-27
EMC immunity/emission	conforms to EN 61000-6-2/EN 61000-6-4
Protection class	IP20
Installation position	variable
Marking ^{*)}	CE, EAC, UKCA

*) Real applicable approvals/markings see type plate on the side (product marking).

2.7.6.3 EL3174-0042 - Connection, display and diagnostics

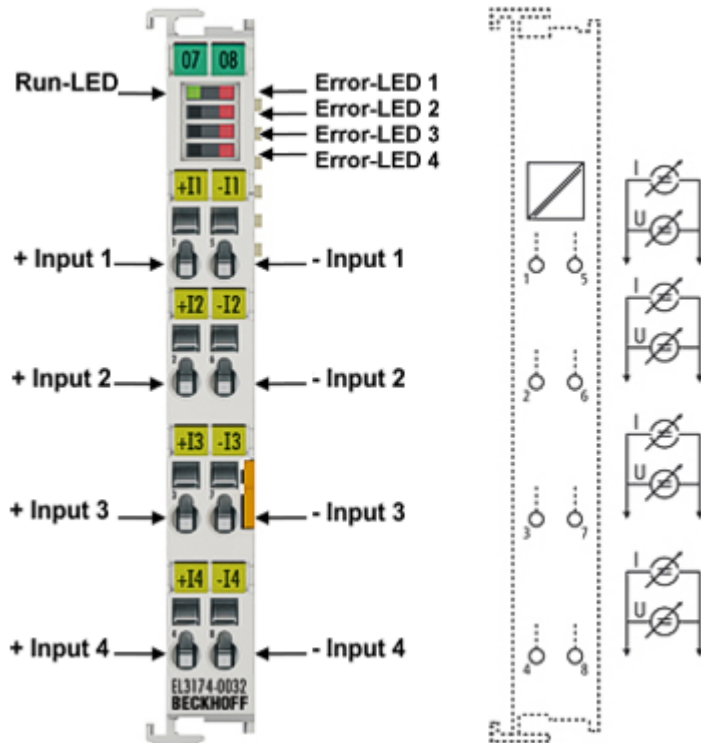

Fig. 58: EL3174-0032 - LEDs and connection

Connection EL3174-0042				
Terminal point		Description	Internally connected with connection	Max. current carrying capacity *)
Designation	No.			
+ Input 1	1	Channel 1, voltage measurement, positive input (+)	-	40 mA
+ Input 2	2	Channel 2, voltage measurement, positive input (+)	-	40 mA
+ Input 3	3	Channel 3, voltage measurement, positive input (+)	-	40 mA
+ Input 4	4	Channel 4, voltage measurement, positive input (+)	-	40 mA
- Input 1	5	Channel 1, voltage measurement, negative input (-)	-	40 mA
- Input 2	6	Channel 2, voltage measurement, negative input (-)	-	40 mA
- Input 3	7	Channel 3, voltage measurement, negative input (-)	-	40 mA
- Input 4	8	Channel 4, voltage measurement, negative input (-)	-	40 mA

*) Constant and peak value

● Overcurrent protection of the 20 mA inputs

i The current inputs are protected against damage by overcurrent by an internal current limitation, currents > 30mA may occur. In the event of a fault, the current limiter must not be overloaded by a voltage > 30V from the source device.

Overcurrent is displayed in the process image as "Overrange". After occurrence, the error condition must be stopped immediately, the source device switched off or disconnected from the input terminal. If the error condition persists for a longer period of time, the internal terminal current limitation reduces the absorbed signal current for thermal reasons, depending on the ambient conditions also below 20 mA.

LEDs			
LED	Color	Meaning	
RUN*	green	This LED indicates the terminal's operating state *:	
		off	State of the EtherCAT State Machine [▶ 139]: INIT = initialization of the terminal or BOOTSTRAP = function for <u>firmware updates</u> [▶ 491] of the terminal
		flashing	State of the EtherCAT State Machine: PREOP = function for mailbox communication and different standard-settings set
		single flash	State of the EtherCAT State Machine: SAFEOP = verification of the <u>Sync Manager</u> [▶ 219] channels and the distributed clocks. Outputs remain in safe state
on	State of the EtherCAT State Machine: OP = normal operating state; mailbox and process data communication is possible		
ERROR**	red	Fault indication in the event of broken wire or undershooting or overshooting of the measuring range	
*) If several RUN LEDs are present, all of them have the same function.			
**) The error display shows the signal processing state for each channel.			

2.7.7 EL3174-0090

2.7.7.1 EL3174-0090 - Introduction

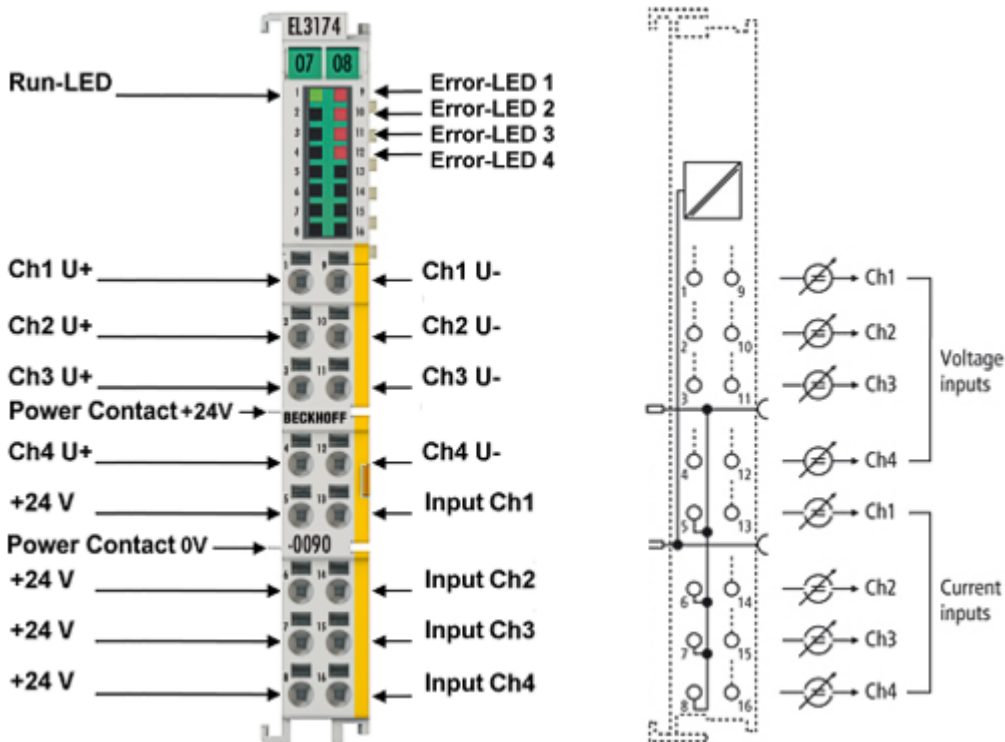

Fig. 59: EL3174-0090

Analog Input Terminal; 4 channel, multi-function, ±10 V, ±20 mA, 16 bit, TwinSAFE SC

The EL3174 analog input terminal has four individually parameterizable inputs. Signals in the range from -10/0 to +10 V or -20/0/+4 to +20 mA can be processed via each channel. Physically, the voltage and current signals should be connected to different terminal points. Each channel should then be set by the controller/TwinCAT to U or I mode via CoE. The voltage inputs operate differentially; the current inputs are single-ended. All inputs are digitized with a resolution of 16 bits and transmitted, electrically isolated, to the higher-level automation device. With a technical measuring range of ±107 % of the nominal range, the terminal also supports commissioning with sensor values in the limit range and diagnostics according to NAMUR NE43.

With the aid of the TwinSAFE SC technology (TwinSAFE Single Channel) it is possible to make use of standard signals for safety tasks in any network or fieldbus. To do this, EtherCAT I/Os from the areas of analog input, position measurement or communication (4...20 mA, incremental encoder, IO-Link, etc.) are extended by the TwinSAFE SC function. The properties typical for the signals and the standard functions of the I/O components are retained. TwinSAFE SC I/Os differ optically from standard I/Os by a yellow stripe on the front of the housing.

The TwinSAFE SC technology enables communication via a TwinSAFE protocol. These connections can be distinguished from the usual secure communication via Safety over EtherCAT.

The data from the TwinSAFE SC components is fed via a TwinSAFE protocol to the TwinSAFE Logic, where it can be used in the context of safety-relevant applications. Detailed examples confirmed/calculated by the TÜV SÜD for the correct application of the TwinSAFE SC components and the respective normative classifications can be found in the TwinSAFE application manual.

● 107% Extended Range

i The EL3174/ EL3174-00xx are preconfigured to a measurement range of 107% (e.g. 0x7FFF correspond to +10.737 V or 3.22 V accordingly). Via CoE access can be reset to the previously known legacy range. Then 0x7FFF correspond to the full scale value or e.g. 10 V (3 V) as before.

Quick-Links

- [EtherCAT basics](#)
- [Process data and operating modes \[▶ 244\]](#)
- [Object description and parameterization \[▶ 473\]](#)

2.7.7.2 EL3174-0090 - Technical data

Technical data		EL3174-0090
Analog inputs		4
ADC type		SAR
Signal voltage		-10/0...+10 V
Signal current		-20/0/+4...+20 mA
Measuring range, nominal (Full Scale Value)	Voltage measurement range	-10/0...+10 V
	Current measurement range	-20/0/+4...+20 mA
Measuring range, technical	Voltage measurement range	-10.73...+10.73 V
	Current measurement range	-21.47...+21.47 mA
Measuring error (full measuring range)		< ±0.3 % (relative to full scale value)
Distributed Clocks		yes
Distributed Clocks precision		<< 1 µs
Support NoCoEStorage [▶ 142]		yes
Resolution		16 bit (incl. sign)
Sampling type		multiplex
Ground reference		U differential, I single-ended
Internal resistance		Voltage measurement: > 200 kΩ Current measurement: 85 Ω typ.
Input filter limit frequency		5 kHz
Common-mode voltage U _{CM}		35 V max. (voltage measurement)
Minimal EtherCAT cycle time		500 µs
Overcurrent protection		50 mA typ.
Bit width of the process image		Inputs: 35 Byte Outputs: 6 Byte
Configuration		no address or configuration settings required
MTBF (+55°C)		>800.000 h
Special features		U/I parameterizable, Extended Range, standard and compact process image, activatable FIR/IIR filters EL3174-0090 with TwinSAFE SC technology
Supply voltage for electronic		via the E-bus
Current consumption via E-bus		typ. 170 mA
Electrical isolation		500 V (E bus/ fieldbus voltage)
Recommended operating voltage range (ground related to GND/ 0V power contact)	Voltage measurement range	U _{CM} 35 V max.
	Current measurement range	single ended, dielectric strength max. 30 V
Recommended signal range	Voltage measurement range	Extended Range (107%), differential
	Current measurement range	Extended Range (107%), single ended
Destruction limit (ground related to GND/ 0V power contact)	Voltage measurement range	50 V
	Current measurement range	30 V
Destruction limit (differential)	Voltage measurement range	50 V
	Current measurement range	n.a.
Weight		approx. 65 g
Permissible ambient temperature range during operation		-25...+60 °C
Permissible ambient temperature range during storage		-40...+85 °C
Permissible relative humidity		95 %, no condensation
Design		HD (High Density) housing with signal LED
Dimensions (W x H x D)		approx. 15 mm x 100 mm x 70 mm (width aligned: 12 mm)
Mounting [▶ 155]		on 35 mm mounting rail conforms to EN 60715
Vibration/shock resistance		conforms to EN 60068-2-6/EN 60068-2-27
EMC immunity/emission		conforms to EN 61000-6-2/EN 61000-6-4
Protection class		IP20
Installation position		variable
Marking / Approval ^{*)}		CE, EAC, UKCA ATEX [▶ 149], IECEx [▶ 150], cFMus [▶ 152] cULus [▶ 154]

*) Real applicable approvals/markings see type plate on the side (product marking).

Ex markings

Standard	Marking
ATEX	II 3 G Ex nA IIC T4 Gc
IECEX	Ex nA IIC T4 Gc
cFMus	Class I, Division 2, Groups A, B, C, D Class I, Zone 2, AEx/Ex ec IIC T4 Gc

2.7.7.3 EL3174-0090 - Connection, display and diagnostics

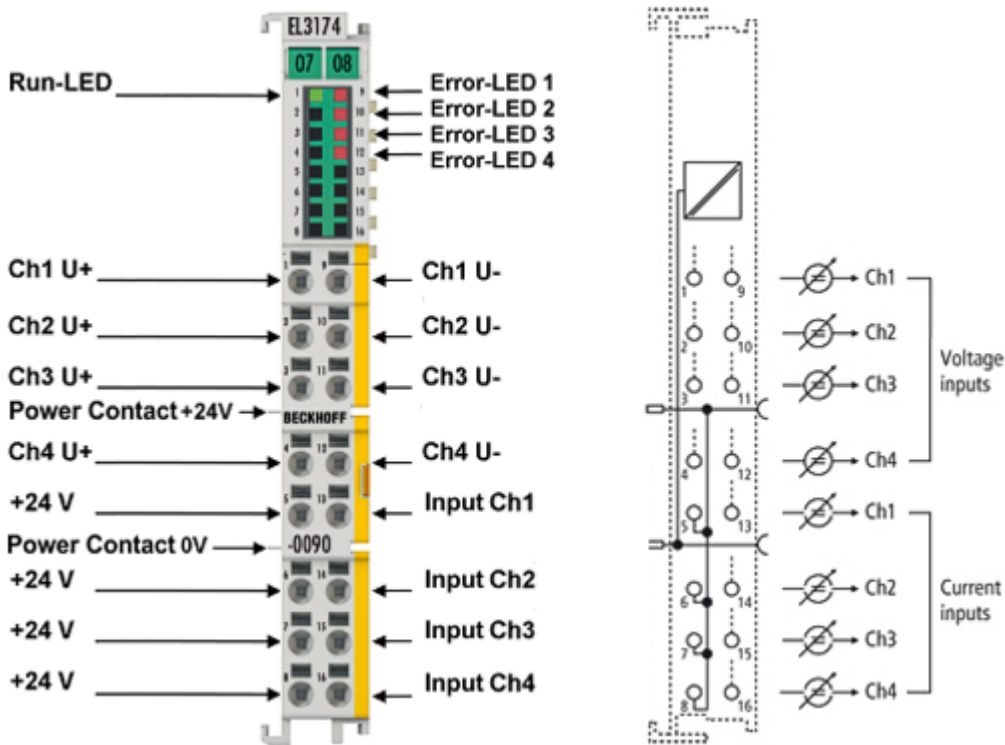

Fig. 60: EL3174-0090 - LEDs and connection

Connection EL3174-0090				
Terminal point		Description	Internally connected with connection	Max. current carrying capacity *)
Name	No.			
Ch1 U+	1	Channel 1, voltage measurement, positive input (U+)	-	not applicable (voltage input)
Ch2 U+	2	Channel 2, voltage measurement, positive input (U+)	-	not applicable (voltage input)
Ch3 U+	3	Channel 3, voltage measurement, positive input (U+)	-	not applicable (voltage input)
Ch4 U+	4	Channel 4, voltage measurement, positive input (U+)	-	not applicable (voltage input)
+24 V	5, 6, 7, 8	+24 V	positive power contact	1 A
Ch1 U-	9	Channel 1, voltage measurement, negative input (U-)	-	not applicable (voltage input)
Ch2 U-	10	Channel 2, voltage measurement, negative input (U-)	-	not applicable (voltage input)
Ch3 U-	11	Channel 3, voltage measurement, negative input (U-)	-	not applicable (voltage input)
Ch4 U-	12	Channel 4, voltage measurement, negative input (U-)	-	not applicable (voltage input)
Input Ch1	13	Channel 1, current measurement, input (I)	-	40 mA
Input Ch2	14	Channel 2, current measurement, input (I)	-	40 mA
Input Ch3	15	Channel 3, current measurement, input (I)	-	40 mA
Input Ch4	16	Channel 4, current measurement, input (I)	-	40 mA
Ch1 U+	1	Channel 1, voltage measurement, positive input (U+)	-	not applicable (voltage input)
Ch2 U+	2	Channel 2, voltage measurement, positive input (U+)	-	not applicable (voltage input)
Ch3 U+	3	Channel 3, voltage measurement, positive input (U+)	-	not applicable (voltage input)

*) Constant and peak value

● **Overcurrent protection of the 20 mA inputs**

I The current inputs are protected against damage by overcurrent by an internal current limitation, currents > 30mA may occur. In the event of a fault, the current limiter must not be overloaded by a voltage > 30V from the source device.

Overcurrent is displayed in the process image as "Overrange". After occurrence, the error condition must be stopped immediately, the source device switched off or disconnected from the input terminal. If the error condition persists for a longer period of time, the internal terminal current limitation reduces the absorbed signal current for thermal reasons, depending on the ambient conditions also below 20 mA.

LEDs			
LED	Color	Meaning	
RUN*	green	This LED indicates the terminal's operating state *:	
		off	State of the EtherCAT State Machine [▶ 139] : INIT = initialization of the terminal or BOOTSTRAP = function for firmware updates [▶ 491] of the terminal
		flashing	State of the EtherCAT State Machine: PREOP = function for mailbox communication and different standard-settings set
		single flash	State of the EtherCAT State Machine: SAFEOP = verification of the Sync Manager [▶ 219] channels and the distributed clocks. Outputs remain in safe state
		on	State of the EtherCAT State Machine: OP = normal operating state; mailbox and process data communication is possible
ERROR**	red	Fault indication in the event of broken wire or undershooting or overshooting of the measuring range	

*) If several RUN LEDs are present, all of them have the same function.

***) The error display shows the signal processing state for each channel.

2.8 Start

For commissioning:

- mount the EL31xx as described in the chapter [Mounting and wiring](#) [► 147]
- configure the EL31xx in TwinCAT as described in the chapter [Commissioning](#) [► 168].

3 Basics communication

3.1 EtherCAT basics

Please refer to the [EtherCAT System Documentation](#) for the EtherCAT fieldbus basics.

3.2 EtherCAT cabling – wire-bound

The cable length between two EtherCAT devices must not exceed 100 m. This results from the FastEthernet technology, which, above all for reasons of signal attenuation over the length of the cable, allows a maximum link length of 5 + 90 + 5 m if cables with appropriate properties are used. See also the [Design recommendations for the infrastructure for EtherCAT/Ethernet](#).

Cables and connectors

For connecting EtherCAT devices only Ethernet connections (cables + plugs) that meet the requirements of at least category 5 (Cat5) according to EN 50173 or ISO/IEC 11801 should be used. EtherCAT uses 4 wires for signal transfer.

EtherCAT uses RJ45 plug connectors, for example. The pin assignment is compatible with the Ethernet standard (ISO/IEC 8802-3).

Pin	Color of conductor	Signal	Description
1	yellow	TD +	Transmission Data +
2	orange	TD -	Transmission Data -
3	white	RD +	Receiver Data +
6	blue	RD -	Receiver Data -

Due to automatic cable detection (auto-crossing) symmetric (1:1) or cross-over cables can be used between EtherCAT devices from Beckhoff.

● Recommended cables



- It is recommended to use the appropriate Beckhoff components e.g.
- cable sets ZK1090-9191-xxxx respectively
 - RJ45 connector, field assembly ZS1090-0005
 - EtherCAT cable, field assembly ZB9010, ZB9020

Suitable cables for the connection of EtherCAT devices can be found on the [Beckhoff website!](#)

E-Bus supply

A bus coupler can supply the EL terminals added to it with the E-bus system voltage of 5 V; a coupler is thereby loadable up to 2 A as a rule (see details in respective device documentation). Information on how much current each EL terminal requires from the E-bus supply is available online and in the catalogue. If the added terminals require more current than the coupler can supply, then power feed terminals (e.g. [EL9410](#)) must be inserted at appropriate places in the terminal strand.

The pre-calculated theoretical maximum E-Bus current is displayed in the TwinCAT System Manager. A shortfall is marked by a negative total amount and an exclamation mark; a power feed terminal is to be placed before such a position.

Number	Box Name	Add...	Type	In Si...	Out ...	E-Bus (mA)
1	Term 1 (EK1100)	1001	EK1100			
2	Term 2 (EL2008)	1002	EL2008		1.0	1890
3	Term 3 (EL2008)	1003	EL2008		1.0	1780
4	Term 4 (EL2008)	1004	EL2008		1.0	1670
5	Term 5 (EL6740...)	1005	EL6740-0010	2.0	2.0	1220
6	Term 6 (EL6740...)	1006	EL6740-0010	2.0	2.0	770
7	Term 7 (EL6740...)	1007	EL6740-0010	2.0	2.0	320
8	Term 8 (EL6740...)	1008	EL6740-0010	2.0	2.0	-130 I
9	Term 9 (EL6740...)	1009	EL6740-0010	2.0	2.0	-580 I

Fig. 61: System manager current calculation

NOTICE

Malfunction possible!
 The same ground potential must be used for the E-Bus supply of all EtherCAT terminals in a terminal block!

3.3 General notes for setting the watchdog

The EtherCAT terminals are equipped with a safety device (watchdog) which, e. g. in the event of interrupted process data traffic, switches the outputs (if present) to a presettable state after a presettable time, depending on the device and setting, e. g. to FALSE (off) or an output value.

The EtherCAT slave controller features two watchdogs:

- Sync Manager (SM) watchdog (default: 100 ms)
- Process Data (PDI) watchdog (default: 100 ms)

Their times are individually parameterized in TwinCAT as follows:

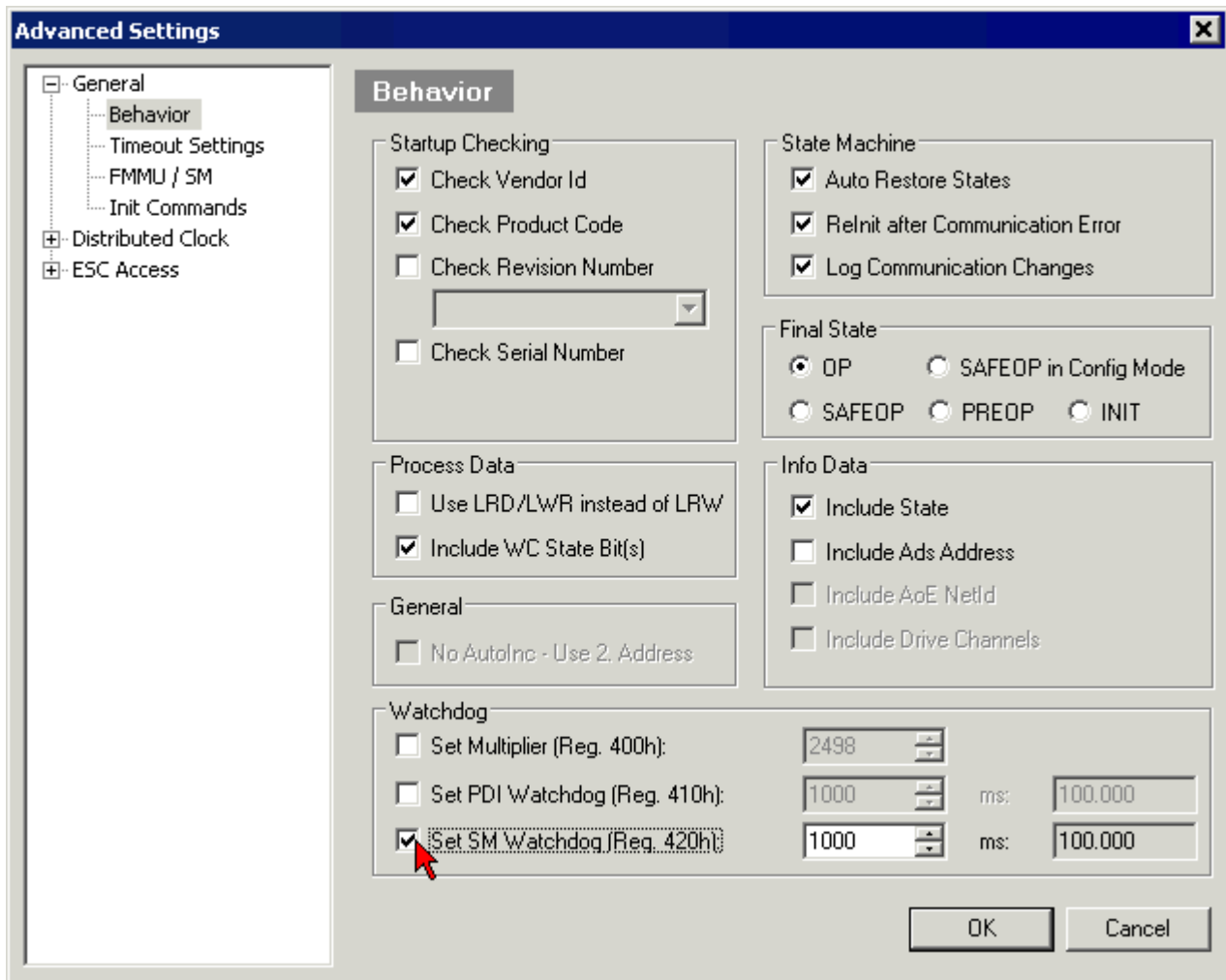

Fig. 62: eEtherCAT tab -> Advanced Settings -> Behavior -> Watchdog

Notes:

- the Multiplier Register 400h (hexadecimal, i. e. 0x0400) is valid for both watchdogs.
- each watchdog has its own timer setting 410h or 420h, which together with the Multiplier results in a resulting time.
- important: the Multiplier/Timer setting is only loaded into the slave at EtherCAT startup if the checkbox in front of it is activated.
- if it is not checked, nothing is downloaded and the setting located in the ESC remains unchanged.
- the downloaded values can be seen in the ESC registers 400h, 410h and 420h: ESC Access -> Memory

SM watchdog (SyncManager Watchdog)

The SyncManager watchdog is reset with each successful EtherCAT process data communication with the terminal. If, for example, no EtherCAT process data communication with the terminal takes place for longer than the set and activated SM watchdog time due to a line interruption, the watchdog is triggered. The status of the terminal (usually OP) remains unaffected. The watchdog is only reset again by a successful EtherCAT process data access.

The SyncManager watchdog is therefore a monitoring for correct and timely process data communication with the ESC from the EtherCAT side.

The maximum possible watchdog time depends on the device. For example, for "simple" EtherCAT slaves (without firmware) with watchdog execution in the ESC it is usually up to 170 seconds. For complex EtherCAT slaves (with firmware) the SM watchdog function is usually parameterized via register 400h/420h

but executed by the microcontroller (μC) and can be significantly lower. In addition, the execution may then be subject to a certain time uncertainty. Since the TwinCAT dialog may allow inputs up to 65535, a test of the desired watchdog time is recommended.

PDI watchdog (Process Data Watchdog)

If there is no PDI communication with the ESC for longer than the set and activated Process Data Interface (PDI) watchdog time, this watchdog is triggered.

The PDI is the internal interface of the ESC, e.g. to local processors in the EtherCAT slave. With the PDI watchdog this communication can be monitored for failure.

The PDI watchdog is therefore a monitoring for correct and timely process data communication with the ESC, but viewed from the application side.

Calculation

Watchdog time = $[1/25 \text{ MHz} * (\text{Watchdog multiplier} + 2)] * \text{SM/PDI watchdog}$

Example: default setting Multiplier = 2498, SM watchdog = 1000 => 100 ms

The value in "Watchdog multiplier + 2" in the formula above corresponds to the number of 40ns base ticks representing one watchdog tick.

⚠ CAUTION

Undefined state possible!

The function for switching off the SM watchdog via SM watchdog = 0 is only implemented in terminals from revision -0016. In previous versions this operating mode should not be used.

⚠ CAUTION

Damage of devices and undefined state possible!

If the SM watchdog is activated and a value of 0 is entered the watchdog switches off completely. This is the deactivation of the watchdog! Set outputs are NOT set in a safe state if the communication is interrupted.

3.4 EtherCAT State Machine

The state of the EtherCAT slave is controlled via the EtherCAT State Machine (ESM). Depending upon the state, different functions are accessible or executable in the EtherCAT slave. Specific commands must be sent by the EtherCAT master to the device in each state, particularly during the bootup of the slave.

A distinction is made between the following states:

- Init
- Pre-Operational
- Safe-Operational
- Operational
- Bootstrap

The regular state of each EtherCAT slave after bootup is the OP state.

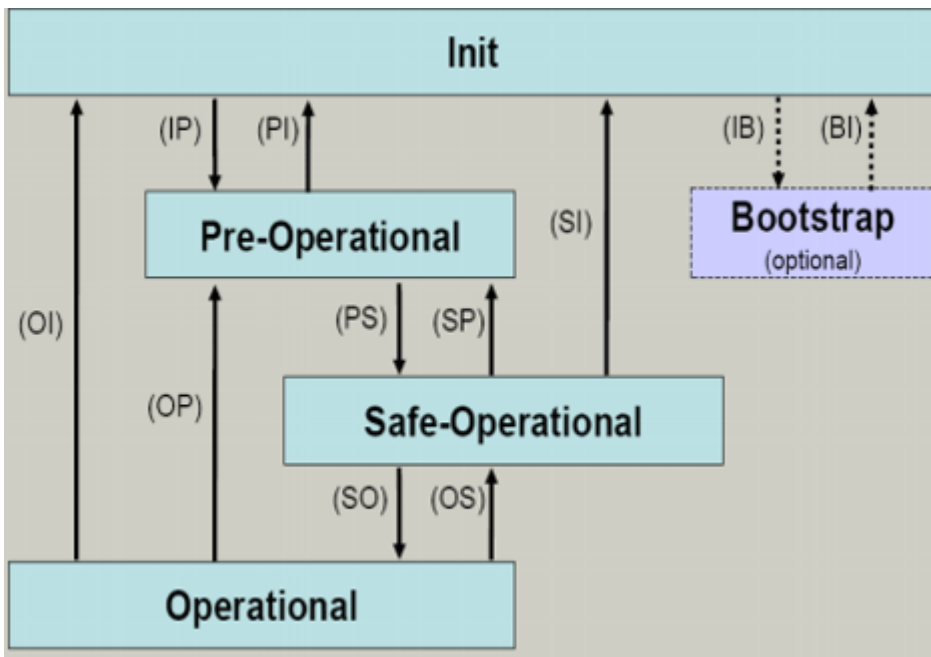

Fig. 63: States of the EtherCAT State Machine

Init

After switch-on the EtherCAT slave in the *Init* state. No mailbox or process data communication is possible. The EtherCAT master initializes sync manager channels 0 and 1 for mailbox communication.

Pre-Operational (Pre-Op)

During the transition between *Init* and *Pre-Op* the EtherCAT slave checks whether the mailbox was initialized correctly.

In *Pre-Op* state mailbox communication is possible, but not process data communication. The EtherCAT master initializes the sync manager channels for process data (from sync manager channel 2), the Fieldbus Memory Management Unit (FMMU) channels and, if the slave supports configurable mapping, PDO mapping or the sync manager PDO assignment. In this state the settings for the process data transfer and perhaps terminal-specific parameters that may differ from the default settings are also transferred.

Safe-Operational (Safe-Op)

During transition between *Pre-Op* and *Safe-Op* the EtherCAT slave checks whether the sync manager channels for process data communication and, if required, the Distributed Clocks settings are correct. Before it acknowledges the change of state, the EtherCAT slave copies current input data into the associated Dual Port (DP)-RAM areas of the ESC.

In *Safe-Op* state mailbox and process data communication is possible, although the slave keeps its outputs in a safe state, while the input data are updated cyclically.

● Outputs in SAFEOP state

i The default set watchdog monitoring sets the outputs of the ESC module in a safe state - depending on the settings in SAFEOP and OP - e.g. in OFF state. If this is prevented by deactivation of the monitoring in the module, the outputs can be switched or set also in the SAFEOP state.

Operational (Op)

Before the EtherCAT master switches the EtherCAT slave from *Safe-Op* to *Op* it must transfer valid output data.

In the *Op* state the slave copies the output data of the masters to its outputs. Process data and mailbox communication is possible.

Boot

In the *Boot* state the slave firmware can be updated. The *Boot* state can only be reached via the *Init* state.

In the *Boot* state mailbox communication via the file access over EtherCAT (FoE) protocol is possible, but no other mailbox communication and no process data communication.

3.5 CoE Interface

General description

The CoE interface (CAN application protocol over EtherCAT interface) is used for parameter management of EtherCAT devices. EtherCAT slaves or the EtherCAT master manage fixed (read only) or variable parameters which they require for operation, diagnostics or commissioning.

CoE parameters are arranged in a table hierarchy. In principle, the user has access via the fieldbus. The EtherCAT master (TwinCAT System Manager) can access the local CoE lists of the slaves via EtherCAT in read or write mode, depending on the attributes.

Different CoE data types are possible, including string (text), integer numbers, Boolean values or larger byte fields. They can be used to describe a wide range of features. Examples of such parameters include manufacturer ID, serial number, process data settings, device name, calibration values for analog measurement or passwords.

The order is specified in two levels via hexadecimal numbering: (main)index, followed by subindex.

The value ranges are

- Index: 0x0000 ...0xFFFF (0...65535_{dec})
- Subindex: 0x00...0xFF (0...255_{dec})

A parameter localized in this way is normally written as 0x8010:07, with preceding "0x" to identify the hexadecimal numerical range and a colon between index and subindex.

The relevant ranges for EtherCAT fieldbus users are:

- 0x1000: This is where fixed identity information for the device is stored, including name, manufacturer, serial number etc., plus information about the current and available process data configurations.
- 0x8000: This is where the operational and functional parameters for all channels are stored, such as filter settings or output frequency.

Other important ranges are:

- 0x4000: here are the channel parameters for some EtherCAT devices. Historically, this was the first parameter area before the 0x8000 area was introduced. EtherCAT devices that were previously equipped with parameters in 0x4000 and changed to 0x8000 support both ranges for compatibility reasons and mirror internally.
- 0x6000: Input PDOs ("inputs" from the perspective of the EtherCAT master)
- 0x7000: Output PDOs ("outputs" from the perspective of the EtherCAT master)

i Availability

Not every EtherCAT device must have a CoE list. Simple I/O modules without dedicated processor usually have no variable parameters and therefore no CoE list.

If a device has a CoE list, it is shown in the TwinCAT System Manager as a separate tab with a listing of the elements:

Index	Name	Flags	Value
1000	Device type	RO	0x00FA1389 (16389001)
1008	Device name	RO	EL2502-0000
1009	Hardware version	RO	
100A	Software version	RO	
1011:0	Restore default parameters	RO	> 1 <
1018:0	Identity	RO	> 4 <
1018:01	Vendor ID	RO	0x00000002 (2)
1018:02	Product code	RO	0x09C63052 (163983442)
1018:03	Revision	RO	0x00130000 (1245184)
1018:04	Serial number	RO	0x00000000 (0)
10F0:0	Backup parameter handling	RO	> 1 <
1400:0	PWM RxDPO-Par Ch.1	RO	> 6 <
1401:0	PWM RxDPO-Par Ch.2	RO	> 6 <
1402:0	PWM RxDPO-Par h.1 Ch.1	RO	> 6 <
1403:0	PWM RxDPO-Par h.1 Ch.2	RO	> 6 <
1600:0	PWM RxDPO-Map Ch.1	RO	> 1 <

Fig. 64: “CoE Online” tab

The figure “CoE Online” tab shows the CoE objects available in device “EL2502”, ranging from 0x1000 to 0x1600. The subindices for 0x1018 are expanded.

NOTICE

Changes in the CoE directory (CAN over EtherCAT directory), program access

When using/manipulating the CoE parameters observe the general CoE notes in chapter “[CoE interface](#)” of the EtherCAT system documentation:

- Keep a startup list if components have to be replaced,
- Distinction between online/offline dictionary,
- Existence of current XML description (download from the [Beckhoff website](#)),
- “CoE-Reload” for resetting the changes
- Program access during operation via PLC (see [TwinCAT3 | PLC Library: Tc2_EtherCAT](#) and [Example program R/W CoE](#))

Data management and function “NoCoeStorage”

Some parameters, particularly the setting parameters of the slave, are configurable and writeable,

- via the System Manager (Fig. “CoE Online” tab) by clicking.
This is useful for commissioning of the system or slaves. Click on the row of the index to be parameterized and enter a value in the “SetValue” dialog.
- from the control system or PLC via ADS, e.g. through blocks from the TcEtherCAT.lib library.
This is recommended for modifications while the system is running or if no System Manager or operating staff are available.

i Data management

If slave CoE parameters are modified online, Beckhoff devices store any changes in a fail-safe manner in the EEPROM, i.e. the modified CoE parameters are still available after a restart. The situation may be different with other manufacturers.

An EEPROM is subject to a limited lifetime with respect to write operations. From typically 100,000 write operations onwards it can no longer be guaranteed that new (changed) data are reliably saved or are still readable. This is irrelevant for normal commissioning. However, if CoE parameters are continuously changed via ADS at machine runtime, it is quite possible for the lifetime limit to be reached. Support for the NoCoeStorage function, which suppresses the saving of changed CoE values, depends on the firmware version.

Please refer to the technical data in this documentation as to whether this applies to the respective device.

- If the function is supported: the function is activated by entering the code word 0x12345678 once in CoE index 0xF008 and remains active as long as the code word is not changed. After switching the device on it is then inactive. Changed CoE values are not saved in the EEPROM and can thus be changed any number of times.
- If the function is not supported: continuous changing of CoE values is not permissible in view of the lifetime limit.

i Startup list

Changes in the local CoE list of the terminal are lost if the terminal is replaced. If a terminal is replaced with a new Beckhoff terminal, it will have the default settings. It is therefore advisable to link all changes in the CoE list of an EtherCAT slave with the Startup list of the slave, which is processed whenever the EtherCAT fieldbus is started. In this way a replacement EtherCAT slave can automatically be parameterized with the specifications of the user.

If EtherCAT slaves are used which are unable to store local CoE values permanently, the Startup list must be used.

Recommended approach for manual modification of CoE parameters

- Make the required change in the System Manager (the values are stored locally in the EtherCAT slave).
- If the value is to be stored permanently, enter it in the Startup list. The order of the Startup entries is usually irrelevant.

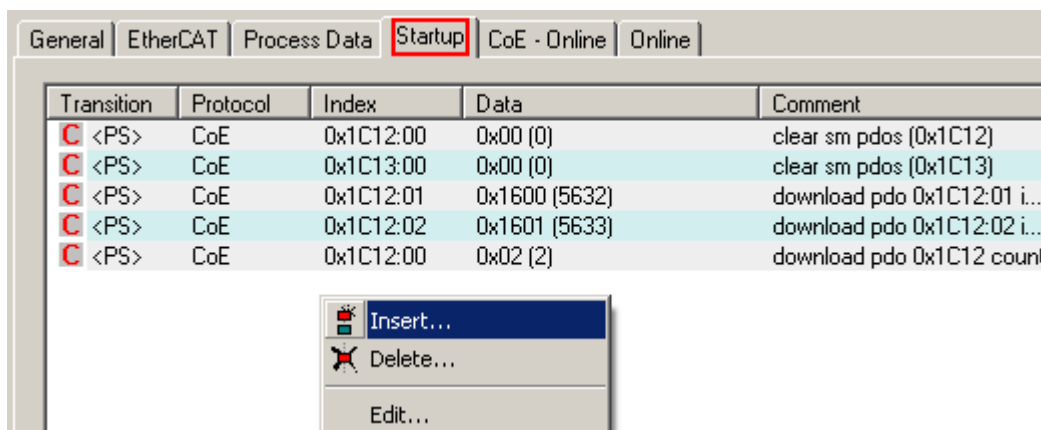

Fig. 65: Startup list in the TwinCAT System Manager

The Startup list may already contain values that were configured by the System Manager based on the ESI specifications. Additional application-specific entries can also be created.

Online / offline list

When working with the TwinCAT System Manager, a distinction must be made as to whether the EtherCAT device is currently "available", i.e. switched on and connected via EtherCAT - i.e. **online** - or whether a configuration is created **offline** without slaves being connected.

In both cases a CoE list as shown in Fig. “CoE online tab” is displayed. The connectivity is shown as offline/online.

- If the slave is offline:
 - The offline list from the ESI file is displayed. In this case modifications are not meaningful or possible.
 - The configured status is shown under Identity.
 - No firmware or hardware version is displayed since these are features of the physical device.
 - **Offline Data** is shown in red.

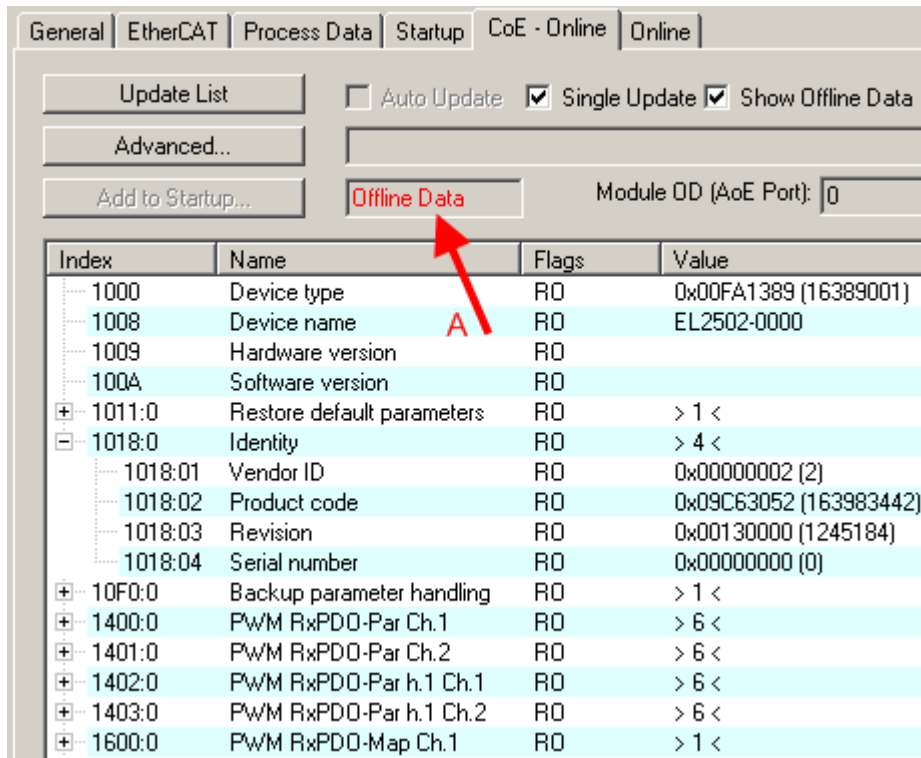

The screenshot shows the 'CoE - Online' tab in the software interface. The 'Offline Data' button is highlighted in red, and a red arrow points to the 'Identity' row in the table below. The table lists various CoE objects with their indices, names, flags, and values.

Index	Name	Flags	Value
1000	Device type	RO	0x00FA1389 (16389001)
1008	Device name	RO	EL2502-0000
1009	Hardware version	RO	
100A	Software version	RO	
1011:0	Restore default parameters	RO	> 1 <
1018:0	Identity	RO	> 4 <
1018:01	Vendor ID	RO	0x00000002 (2)
1018:02	Product code	RO	0x09C63052 (163983442)
1018:03	Revision	RO	0x00130000 (1245184)
1018:04	Serial number	RO	0x00000000 (0)
10F0:0	Backup parameter handling	RO	> 1 <
1400:0	PWM RxDPO-Par Ch.1	RO	> 6 <
1401:0	PWM RxDPO-Par Ch.2	RO	> 6 <
1402:0	PWM RxDPO-Par h.1 Ch.1	RO	> 6 <
1403:0	PWM RxDPO-Par h.1 Ch.2	RO	> 6 <
1600:0	PWM RxDPO-Map Ch.1	RO	> 1 <

Fig. 66: Offline list

- If the slave is online:
 - The actual current slave list is read. This may take several seconds, depending on the size and cycle time.
 - The actual identity is displayed.
 - The firmware and hardware status of the device is displayed in the CoE.
 - **Online Data** is shown in green.

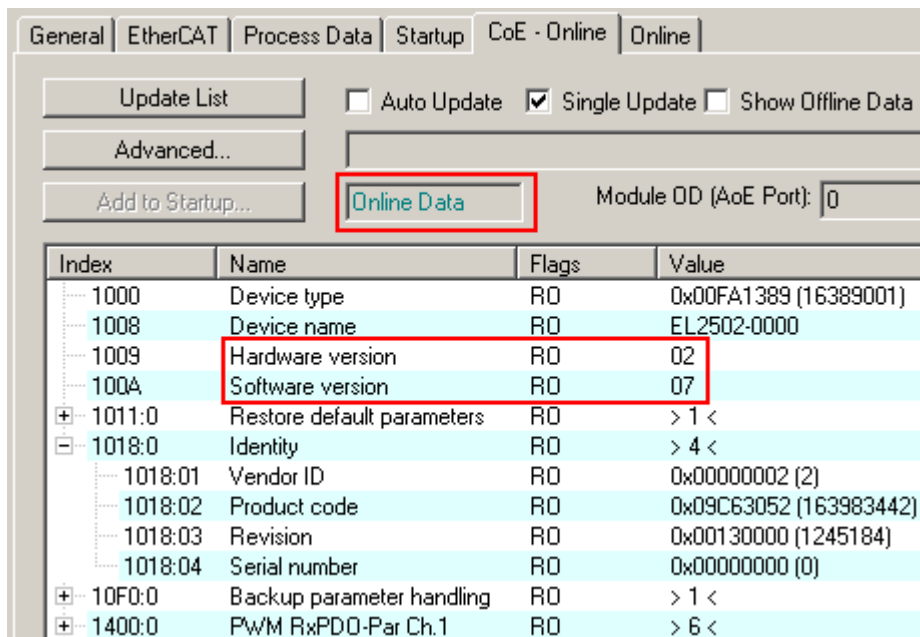

Fig. 67: Online list

Channel-based order

The CoE list is available in EtherCAT devices that usually feature several functionally equivalent channels, for example, a 4-channel analog input terminal also has four logical channels and therefore four identical sets of parameter data for the channels. In order to avoid having to list each channel in the documentation, the placeholder “n” tends to be used for the individual channel numbers.

In the CoE system 16 indices, each with 255 subindices, are generally sufficient for representing all channel parameters. The channel-based order is therefore arranged in 16_{dec} or 10_{hex} steps. The parameter range 0x8000 exemplifies this:

- Channel 0: parameter range 0x8000:00 ... 0x800F:255
- Channel 1: parameter range 0x8010:00 ... 0x801F:255
- Channel 2: parameter range 0x8020:00 ... 0x802F:255
- ...

This is generally written as 0x80n0.

Detailed information on the CoE interface can be found in the [EtherCAT system documentation](#) on the Beckhoff website.

3.6 Distributed Clock

The distributed clock represents a local clock in the EtherCAT slave controller (ESC) with the following characteristics:

- Unit *1 ns*
- Zero point *1.1.2000 00:00*
- Size *64 bit* (sufficient for the next 584 years; however, some EtherCAT slaves only offer 32-bit support, i.e. the variable overflows after approx. 4.2 seconds)
- The EtherCAT master automatically synchronizes the local clock with the master clock in the EtherCAT bus with a precision of < 100 ns.

For detailed information please refer to the [EtherCAT system description](#).

4 Mounting and wiring

4.1 Instructions for ESD protection

NOTICE

Destruction of the devices by electrostatic discharge possible!

The devices contain components at risk from electrostatic discharge caused by improper handling.

- When handling the components, ensure that there is no electrostatic discharge; also avoid touching the spring contacts directly (see illustration).
- Contact with highly insulating materials (synthetic fibers, plastic films, etc.) should be avoided when handling components at the same time.
- When handling the components, ensure that the environment (workplace, packaging and persons) is properly earthed.
- Each bus station must be terminated on the right-hand side with the [EL9011](#) or [EL9012](#) end cap to ensure the degree of protection and ESD protection.

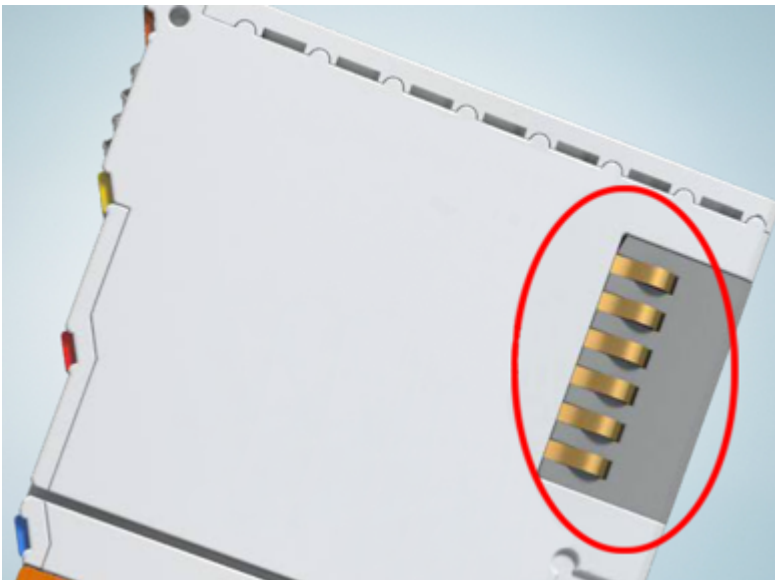

Fig. 68: Spring contacts of the Beckhoff I/O components

4.2 Explosion protection

4.2.1 ATEX - Special conditions (standard temperature range)

⚠ WARNING

Observe the special conditions for the intended use of Beckhoff fieldbus components with standard temperature range in potentially explosive areas (directive 2014/34/EU)!

- The certified components are to be installed in a suitable housing that guarantees a protection class of at least IP54 in accordance with EN 60079-15! The environmental conditions during use are thereby to be taken into account!
- For dust (only the fieldbus components of certificate no. KEMA 10ATEX0075 X Issue 9): The equipment shall be installed in a suitable enclosure providing a degree of protection of IP54 according to EN 60079-31 for group IIIA or IIIB and IP6X for group IIIC, taking into account the environmental conditions under which the equipment is used!
- If the temperatures during rated operation are higher than 70°C at the feed-in points of cables, lines or pipes, or higher than 80°C at the wire branching points, then cables must be selected whose temperature data correspond to the actual measured temperature values!
- Observe the permissible ambient temperature range of 0 to 55°C for the use of Beckhoff fieldbus components standard temperature range in potentially explosive areas!
- Measures must be taken to protect against the rated operating voltage being exceeded by more than 40% due to short-term interference voltages!
- The individual terminals may only be unplugged or removed from the Bus Terminal system if the supply voltage has been switched off or if a non-explosive atmosphere is ensured!
- The connections of the certified components may only be connected or disconnected if the supply voltage has been switched off or if a non-explosive atmosphere is ensured!
- The fuses of the KL92xx/EL92xx power feed terminals may only be exchanged if the supply voltage has been switched off or if a non-explosive atmosphere is ensured!
- Address selectors and ID switches may only be adjusted if the supply voltage has been switched off or if a non-explosive atmosphere is ensured!

Standards

The fundamental health and safety requirements are fulfilled by compliance with the following standards:

- EN 60079-0:2012+A11:2013
- EN 60079-15:2010
- EN 60079-31:2013 (only for certificate no. KEMA 10ATEX0075 X Issue 9)

Marking

The Beckhoff fieldbus components with standard temperature range certified according to the ATEX directive for potentially explosive areas bear one of the following markings:



II 3G KEMA 10ATEX0075 X Ex nA IIC T4 Gc Ta: 0 ... +55°C

II 3D KEMA 10ATEX0075 X Ex tc IIIC T135°C Dc Ta: 0 ... +55°C
(only for fieldbus components of certificate no. KEMA 10ATEX0075 X Issue 9)

or



II 3G KEMA 10ATEX0075 X Ex nA nC IIC T4 Gc Ta: 0 ... +55°C

II 3D KEMA 10ATEX0075 X Ex tc IIIC T135°C Dc Ta: 0 ... +55°C
(only for fieldbus components of certificate no. KEMA 10ATEX0075 X Issue 9)

4.2.2 ATEX - Special conditions (extended temperature range)

⚠ WARNING

Observe the special conditions for the intended use of Beckhoff fieldbus components with extended temperature range (ET) in potentially explosive areas (directive 2014/34/EU)!

- The certified components are to be installed in a suitable housing that guarantees a protection class of at least IP54 in accordance with EN 60079-15! The environmental conditions during use are thereby to be taken into account!
- For dust (only the fieldbus components of certificate no. KEMA 10ATEX0075 X Issue 9): The equipment shall be installed in a suitable enclosure providing a degree of protection of IP54 according to EN 60079-31 for group IIIA or IIIB and IP6X for group IIIC, taking into account the environmental conditions under which the equipment is used!
- If the temperatures during rated operation are higher than 70°C at the feed-in points of cables, lines or pipes, or higher than 80°C at the wire branching points, then cables must be selected whose temperature data correspond to the actual measured temperature values!
- Observe the permissible ambient temperature range of -25 to 60°C for the use of Beckhoff fieldbus components with extended temperature range (ET) in potentially explosive areas!
- Measures must be taken to protect against the rated operating voltage being exceeded by more than 40% due to short-term interference voltages!
- The individual terminals may only be unplugged or removed from the Bus Terminal system if the supply voltage has been switched off or if a non-explosive atmosphere is ensured!
- The connections of the certified components may only be connected or disconnected if the supply voltage has been switched off or if a non-explosive atmosphere is ensured!
- The fuses of the KL92xx/EL92xx power feed terminals may only be exchanged if the supply voltage has been switched off or if a non-explosive atmosphere is ensured!
- Address selectors and ID switches may only be adjusted if the supply voltage has been switched off or if a non-explosive atmosphere is ensured!

Standards

The fundamental health and safety requirements are fulfilled by compliance with the following standards:

- EN 60079-0:2012+A11:2013
- EN 60079-15:2010
- EN 60079-31:2013 (only for certificate no. KEMA 10ATEX0075 X Issue 9)

Marking

The Beckhoff fieldbus components with extended temperature range (ET) certified according to the ATEX directive for potentially explosive areas bear the following marking:



II 3G KEMA 10ATEX0075 X Ex nA IIC T4 Gc Ta: -25 ... +60°C
 II 3D KEMA 10ATEX0075 X Ex tc IIIC T135°C Dc Ta: -25 ... +60°C
 (only for fieldbus components of certificate no. KEMA 10ATEX0075 X Issue 9)

or



II 3G KEMA 10ATEX0075 X Ex nA nC IIC T4 Gc Ta: -25 ... +60°C
 II 3D KEMA 10ATEX0075 X Ex tc IIIC T135°C Dc Ta: -25 ... +60°C
 (only for fieldbus components of certificate no. KEMA 10ATEX0075 X Issue 9)

4.2.3 IECEx - Special conditions

WARNING

Observe the special conditions for the intended use of Beckhoff fieldbus components in potentially explosive areas!

- For gas: The equipment shall be installed in a suitable enclosure providing a degree of protection of IP54 according to IEC 60079-15, taking into account the environmental conditions under which the equipment is used!
- For dust (only the fieldbus components of certificate no. IECEx DEK 16.0078X Issue 3): The equipment shall be installed in a suitable enclosure providing a degree of protection of IP54 according to EN 60079-31 for group IIIA or IIIB and IP6X for group IIIC, taking into account the environmental conditions under which the equipment is used!
- The equipment shall only be used in an area of at least pollution degree 2, as defined in IEC 60664-1!
- Provisions shall be made to prevent the rated voltage from being exceeded by transient disturbances of more than 119 V!
- If the temperatures during rated operation are higher than 70°C at the feed-in points of cables, lines or pipes, or higher than 80°C at the wire branching points, then cables must be selected whose temperature data correspond to the actual measured temperature values!
- Observe the permissible ambient temperature range for the use of Beckhoff fieldbus components in potentially explosive areas!
- The individual terminals may only be unplugged or removed from the Bus Terminal system if the supply voltage has been switched off or if a non-explosive atmosphere is ensured!
- The connections of the certified components may only be connected or disconnected if the supply voltage has been switched off or if a non-explosive atmosphere is ensured!
- Address selectors and ID switches may only be adjusted if the supply voltage has been switched off or if a non-explosive atmosphere is ensured!
- The front hatch of certified units may only be opened if the supply voltage has been switched off or a non-explosive atmosphere is ensured!

Standards

The fundamental health and safety requirements are fulfilled by compliance with the following standards:

- EN 60079-0:2011
- EN 60079-15:2010
- EN 60079-31:2013 (only for certificate no. IECEx DEK 16.0078X Issue 3)

Marking

Beckhoff fieldbus components that are certified in accordance with IECEx for use in areas subject to an explosion hazard bear the following markings:

Marking for fieldbus components of certificate no. IECEx DEK 16.0078X Issue 3:	IECEx DEK 16.0078 X
	Ex nA IIC T4 Gc
	Ex tc IIIC T135°C Dc

Marking for fieldbus components of certificates with later issues:	IECEx DEK 16.0078 X
	Ex nA IIC T4 Gc

4.2.4 Continulative documentation for ATEX and IECEx

NOTICE



Continulative documentation about explosion protection according to ATEX and IECEx

Pay also attention to the continuative documentation

Ex. Protection for Terminal Systems

Notes on the use of the Beckhoff terminal systems in hazardous areas according to ATEX and IECEx,

that is available for [download](#) within the download area of your product on the Beckhoff homepage www.beckhoff.com!

4.2.5 cFMus - Special conditions

WARNING

Observe the special conditions for the intended use of Beckhoff fieldbus components in potentially explosive areas!

- The equipment shall be installed within an enclosure that provides a minimum ingress protection of IP54 in accordance with ANSI/UL 60079-0 (US) or CSA C22.2 No. 60079-0 (Canada).
- The equipment shall only be used in an area of at least pollution degree 2, as defined in IEC 60664-1.
- Transient protection shall be provided that is set at a level not exceeding 140% of the peak rated voltage value at the supply terminals to the equipment.
- The circuits shall be limited to overvoltage Category II as defined in IEC 60664-1.
- The Fieldbus Components may only be removed or inserted when the system supply and the field supply are switched off, or when the location is known to be non-hazardous.
- The Fieldbus Components may only be disconnected or connected when the system supply is switched off, or when the location is known to be non-hazardous.

Standards

The fundamental health and safety requirements are fulfilled by compliance with the following standards:

M20US0111X (US):

- FM Class 3600:2018
- FM Class 3611:2018
- FM Class 3810:2018
- ANSI/UL 121201:2019
- ANSI/ISA 61010-1:2012
- ANSI/UL 60079-0:2020
- ANSI/UL 60079-7:2017

FM20CA0053X (Canada):

- CAN/CSA C22.2 No. 213-17:2017
- CSA C22.2 No. 60079-0:2019
- CAN/CSA C22.2 No. 60079-7:2016
- CAN/CSA C22.2 No.61010-1:2012

Marking

Beckhoff fieldbus components that are certified in accordance with cFMus for use in areas subject to an explosion hazard bear the following markings:

FM20US0111X (US): **Class I, Division 2, Groups A, B, C, D**
 Class I, Zone 2, AEx ec IIC T4 Gc

FM20CA0053X (Canada): **Class I, Division 2, Groups A, B, C, D**
 Ex ec T4 Gc

4.2.6 Continulative documentation for cFMus

NOTICE



Continulative documentation about explosion protection according to cFMus

Pay also attention to the continuative documentation

Control Drawing I/O, CX, CPX

Connection diagrams and Ex markings,

that is available for download within the download area of your product on the Beckhoff homepage www.beckhoff.com!

4.3 UL notice

⚠ CAUTION



Application

Beckhoff EtherCAT modules are intended for use with Beckhoff's UL Listed EtherCAT System only.

⚠ CAUTION



Examination

For cULus examination, the Beckhoff I/O System has only been investigated for risk of fire and electrical shock (in accordance with UL508 and CSA C22.2 No. 142).

⚠ CAUTION



For devices with Ethernet connectors

Not for connection to telecommunication circuits.

Basic principles

UL certification according to UL508. Devices with this kind of certification are marked by this sign:



4.4 Installation on mounting rails

⚠ WARNING

Risk of electric shock and damage of device!

Bring the bus terminal system into a safe, powered down state before starting installation, disassembly or wiring of the bus terminals!

The Bus Terminal system and is designed for mounting in a control cabinet or terminal box.

Assembly

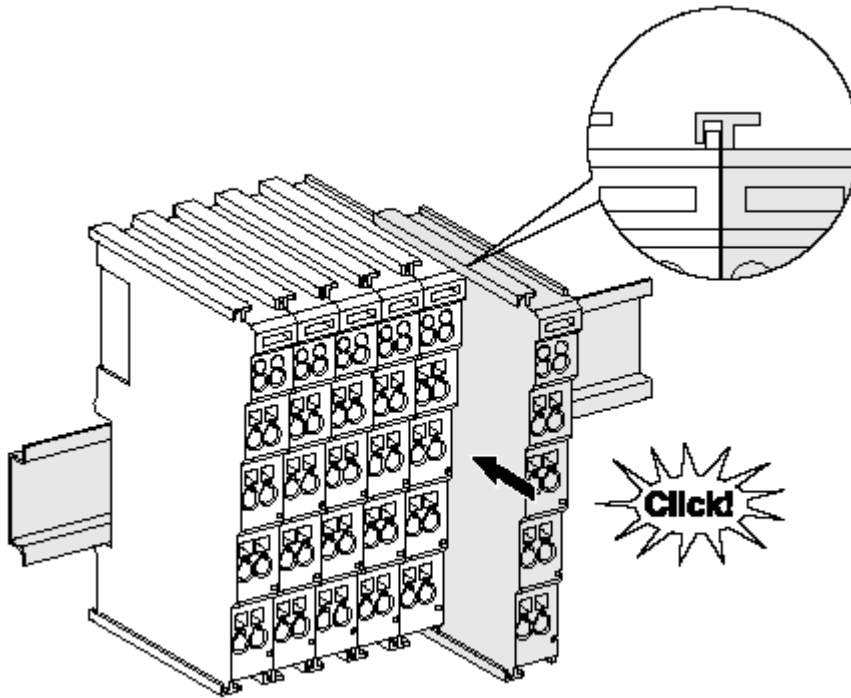

Fig. 69: Attaching on mounting rail

The bus coupler and bus terminals are attached to commercially available 35 mm mounting rails (DIN rails according to EN 60715) by applying slight pressure:

1. First attach the fieldbus coupler to the mounting rail.
2. The bus terminals are now attached on the right-hand side of the fieldbus coupler. Join the components with tongue and groove and push the terminals against the mounting rail, until the lock clicks onto the mounting rail.

If the terminals are clipped onto the mounting rail first and then pushed together without tongue and groove, the connection will not be operational! When correctly assembled, no significant gap should be visible between the housings.

i Fixing of mounting rails

The locking mechanism of the terminals and couplers extends to the profile of the mounting rail. At the installation, the locking mechanism of the components must not come into conflict with the fixing bolts of the mounting rail. To mount the mounting rails with a height of 7.5 mm under the terminals and couplers, you should use flat mounting connections (e.g. countersunk screws or blind rivets).

Disassembly

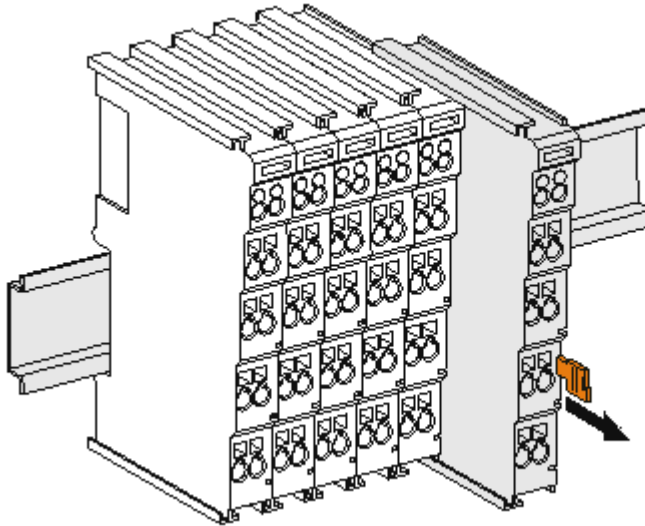

Fig. 70: Disassembling of terminal

Each terminal is secured by a lock on the mounting rail, which must be released for disassembly:

1. Pull the terminal by its orange-colored lugs approximately 1 cm away from the mounting rail. In doing so for this terminal the mounting rail lock is released automatically and you can pull the terminal out of the bus terminal block easily without excessive force.
2. Grasp the released terminal with thumb and index finger simultaneous at the upper and lower grooved housing surfaces and pull the terminal out of the bus terminal block.

Connections within a bus terminal block

The electric connections between the Bus Coupler and the Bus Terminals are automatically realized by joining the components:

- The six spring contacts of the K-Bus/E-Bus deal with the transfer of the data and the supply of the Bus Terminal electronics.
- The power contacts deal with the supply for the field electronics and thus represent a supply rail within the bus terminal block. The power contacts are supplied via terminals points on the Bus Coupler (up to 24 V) or for higher voltages via power feed terminals.

● Power Contacts

i During the design of a bus terminal block, the pin assignment of the individual Bus Terminals must be taken account of, since some types (e.g. analog Bus Terminals or digital 4-channel Bus Terminals) do not or not fully loop through the power contacts. Power Feed Terminals (KL91xx, KL92xx or EL91xx, EL92xx) interrupt the power contacts and thus represent the start of a new supply rail.

PE power contact

The power contact labeled PE can be used as a protective earth. For safety reasons this contact mates first when plugging together, and can ground short-circuit currents of up to 125 A.

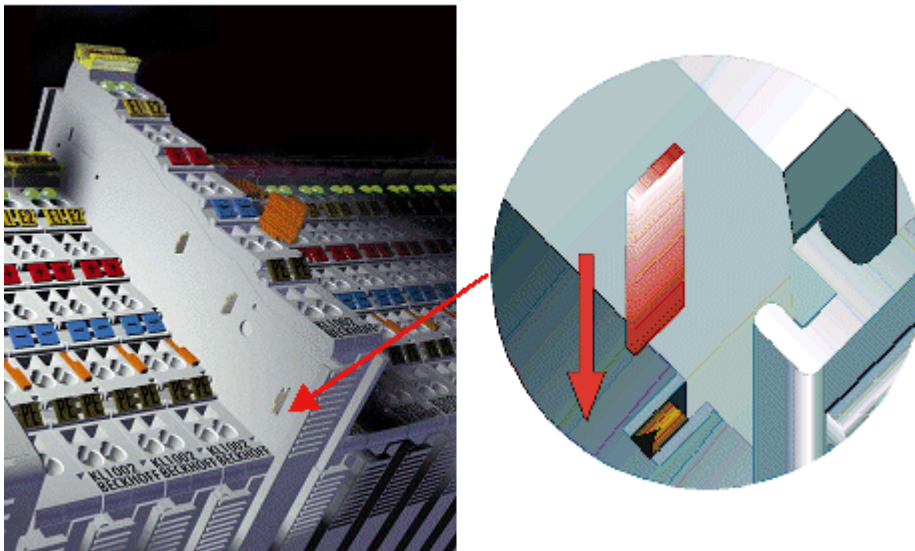

Fig. 71: Power contact on left side

NOTICE

Possible damage of the device

Note that, for reasons of electromagnetic compatibility, the PE contacts are capacitatively coupled to the mounting rail. This may lead to incorrect results during insulation testing or to damage on the terminal (e.g. disruptive discharge to the PE line during insulation testing of a consumer with a nominal voltage of 230 V). For insulation testing, disconnect the PE supply line at the Bus Coupler or the Power Feed Terminal! In order to decouple further feed points for testing, these Power Feed Terminals can be released and pulled at least 10 mm from the group of terminals.

⚠ WARNING

Risk of electric shock!

The PE power contact must not be used for other potentials!

4.5 Installation instructions for enhanced mechanical load capacity

⚠ WARNING

Risk of injury through electric shock and damage to the device!

Bring the Bus Terminal system into a safe, de-energized state before starting mounting, disassembly or wiring of the Bus Terminals!

Additional checks

The terminals have undergone the following additional tests:

Verification	Explanation
Vibration	10 frequency runs in 3 axes
	6 Hz < f < 60 Hz displacement 0.35 mm, constant amplitude
	60.1 Hz < f < 500 Hz acceleration 5 g, constant amplitude
Shocks	1000 shocks in each direction, in 3 axes
	25 g, 6 ms

Additional installation instructions and notes

For terminals with enhanced mechanical load capacity, the following additional installation instructions and notes apply:

- The enhanced mechanical load capacity is valid for all permissible installation positions.
- Use a mounting rail according to EN 60715 TH35-15.
- Fix the terminal segment on both sides of the mounting rail with a mechanical fixture, e.g. an earth terminal or reinforced end clamp.
- The maximum total extension of the terminal segment (without coupler) is:
64 terminals (12 mm mounting width) or 32 terminals (24 mm mounting width)
- Avoid deformation, twisting, crushing and bending of the mounting rail during edging and installation of the rail.
- The mounting points of the mounting rail must be set at 5 cm intervals.
- Use countersunk head screws to fasten the mounting rail.
- The free length between the strain relief and the wire connection should be kept as short as possible. A distance of approx. 10 cm should be maintained to the cable duct.

4.6 Connection

4.6.1 Connection system

⚠ WARNING

Risk of electric shock and damage of device!

Bring the bus terminal system into a safe, powered down state before starting installation, disassembly or wiring of the bus terminals!

Overview

The bus terminal system offers different connection options for optimum adaptation to the respective application:

- The terminals of ELxxxx and KLxxxx series with standard wiring include electronics and connection level in a single enclosure.
- The terminals of ESxxxx and KSxxxx series feature a pluggable connection level and enable steady wiring while replacing.
- The High Density Terminals (HD Terminals) include electronics and connection level in a single enclosure and have advanced packaging density.

Standard wiring (ELxxxx / KLxxxx)



Fig. 72: Standard wiring

The terminals of the ELxxxx and KLxxxx series integrate screwless spring-cage technology for quick and easy wiring.

Pluggable wiring (ESxxxx / KSxxxx)



Fig. 73: Pluggable wiring

The terminals of ESxxxx and KSxxxx series feature a pluggable connection level. The assembly and wiring procedure is the same as for the ELxxxx and KLxxxx series. The pluggable connection level enables the complete wiring to be removed as a plug connector from the top of the housing for servicing. The lower section can be removed from the terminal block by pulling the unlocking tab. Insert the new component and plug in the connector with the wiring. This reduces the installation time and eliminates the risk of wires being mixed up.

The familiar dimensions of the terminal only had to be changed slightly. The new connector adds about 3 mm. The maximum height of the terminal remains unchanged.

A tab for strain relief of the cable simplifies assembly in many applications and prevents tangling of individual connection wires when the connector is removed.

Conductor cross sections between 0.08 mm² and 2.5 mm² can continue to be used with the proven spring force technology.

The overview and nomenclature of the product names for ESxxxx and KSxxxx series has been retained as known from ELxxxx and KLxxxx series.

High Density Terminals (HD Terminals)



Fig. 74: High Density Terminals

The terminals from these series with 16 terminal points are distinguished by a particularly compact design, as the packaging density is twice as large as that of the standard 12 mm bus terminals. Massive conductors and conductors with a wire end sleeve can be inserted directly into the spring loaded terminal point without tools.

● **Wiring HD Terminals**

i The High Density Terminals of the ELx8xx and KLx8xx series doesn't support pluggable wiring.

Ultrasonically compacted (ultrasonically welded) strands

● **Ultrasonically compacted (ultrasonically welded) strands**

i Ultrasonically compacted (ultrasonically welded) strands can also be connected to the standard and high-density terminals. In this case, please note the tables concerning the wire-size width [► 162]!

4.6.2 Wiring

⚠ WARNING

Risk of electric shock and damage of device!

Bring the bus terminal system into a safe, powered down state before starting installation, disassembly or wiring of the bus terminals!

Terminals for standard wiring ELxxxx/KLxxxx and for pluggable wiring ESxxxx/KSxxxx

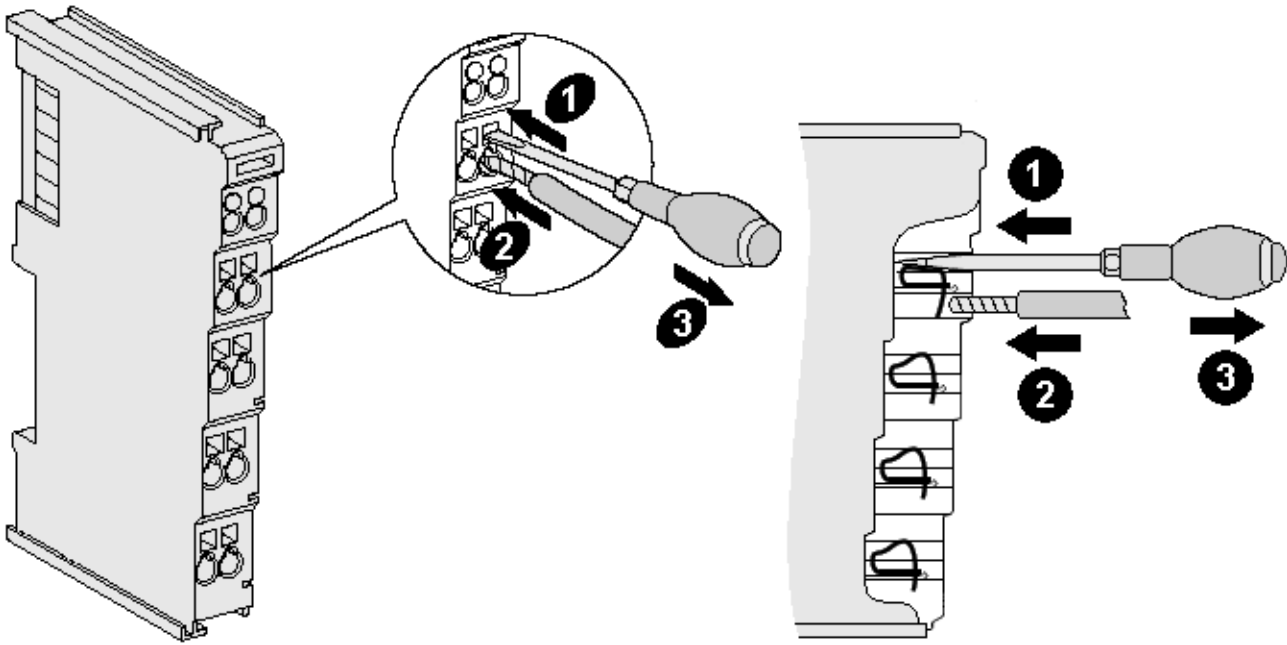

Fig. 75: Connecting a cable on a terminal point

Up to eight terminal points enable the connection of solid or finely stranded cables to the bus terminal. The terminal points are implemented in spring force technology. Connect the cables as follows (see fig. “Connecting a cable on a terminal point”):

1. Open a terminal point by pushing a screwdriver straight against the stop into the square opening above the terminal point. Do not turn the screwdriver or move it alternately (don't toggle).
2. The wire can now be inserted into the round terminal opening without any force.
3. When the screwdriver is removed, the terminal point closes automatically and holds the wire securely and permanently in place

See the following table for the suitable wire size width:

Terminal housing	ELxxxx, KLxxxx	ESxxxx, KSxxxx
Wire size width (single core wires)	0.08 ... 2.5 mm ²	0.08 ... 2.5 mm ²
Wire size width (fine-wire conductors)	0.08 ... 2.5 mm ²	0.08 ... 2.5 mm ²
Wire size width (conductors with a wire end sleeve)	0.14 ... 1.5 mm ²	0.14 ... 1.5 mm ²
Wire stripping length	8 ... 9 mm	9 ... 10 mm

High Density Terminals ([HD Terminals](#) [[▶ 160](#)]) with 16 terminal points

The conductors of the HD Terminals are connected without tools for single-wire conductors using the direct plug-in technique, i.e. after stripping the wire is simply plugged into the terminal point. The cables are released, as usual, using the contact release with the aid of a screwdriver. See the following table for the suitable wire size width.

Terminal housing	High Density Housing
Wire size width (single core wires)	0.08 ... 1.5 mm ²
Wire size width (fine-wire conductors)	0.25 ... 1.5 mm ²
Wire size width (conductors with a wire end sleeve)	0.14 ... 0.75 mm ²
Wire size width (ultrasonically compacted [ultrasonically welded] strands)	only 1.5 mm ² (see notice [▶ 160])
Wire stripping length	8 ... 9 mm

4.6.3 Shielding

● Shielding

i Encoder, analog sensors and actuators should always be connected with shielded, twisted paired wires.

4.7 Note - power supply

WARNING

Power supply from SELV / PELV power supply unit!

SELV / PELV circuits (safety extra-low voltage / protective extra-low voltage) according to IEC 61010-2-201 must be used to supply this device.

Notes:

- SELV / PELV circuits may give rise to further requirements from standards such as IEC 60204-1 et al, for example with regard to cable spacing and insulation.
- A SELV supply provides safe electrical isolation and limitation of the voltage without a connection to the protective conductor, a PELV supply also requires a safe connection to the protective conductor.

4.8 Installation positions

NOTICE

Constraints regarding installation position and operating temperature range

Please refer to the technical data for a terminal to ascertain whether any restrictions regarding the installation position and/or the operating temperature range have been specified. When installing high power dissipation terminals ensure that an adequate spacing is maintained between other components above and below the terminal in order to guarantee adequate ventilation!

Optimum installation position (standard)

The optimum installation position requires the mounting rail to be installed horizontally and the connection surfaces of the EL- / KL terminals to face forward (see Fig. "Recommended distances for standard installation position"). The terminals are ventilated from below, which enables optimum cooling of the electronics through convection. "From below" is relative to the acceleration of gravity.

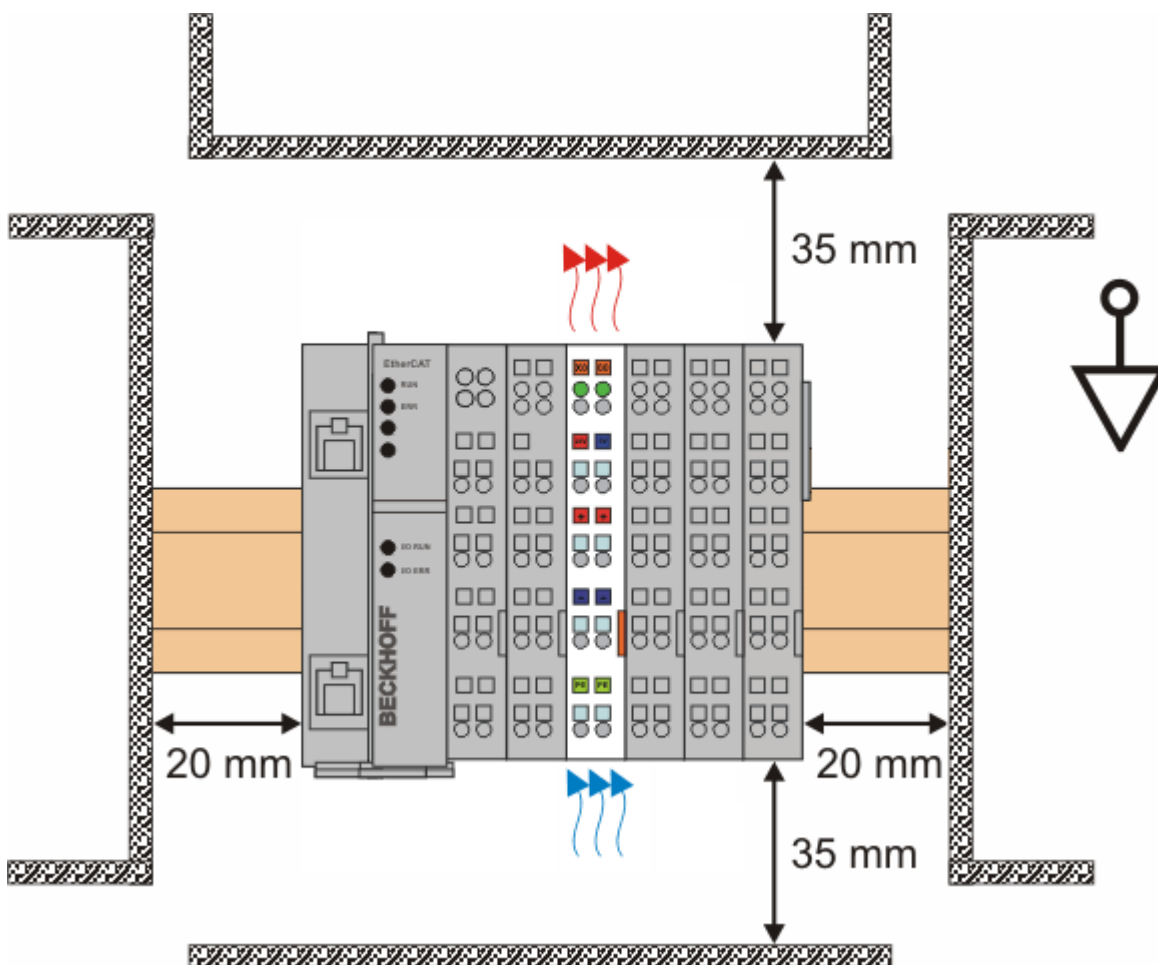

Fig. 76: Recommended distances for standard installation position

Compliance with the distances shown in Fig. "Recommended distances for standard installation position" is recommended.

Other installation positions

All other installation positions are characterized by different spatial arrangement of the mounting rail - see Fig "Other installation positions".

The minimum distances to ambient specified above also apply to these installation positions.

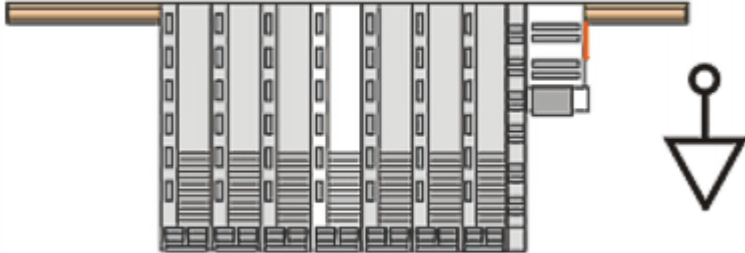
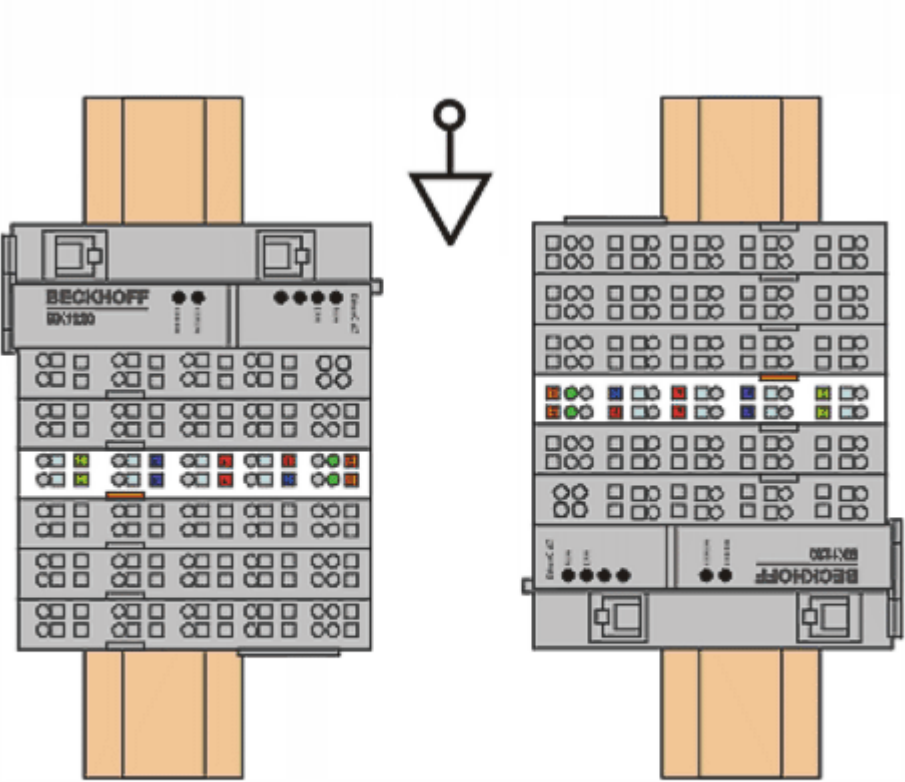

Fig. 77: Other installation positions

4.9 Positioning of passive Terminals

i **Hint for positioning of passive terminals in the bus terminal block**

EtherCAT Terminals (ELxxxx / ESxxxx), which do not take an active part in data transfer within the bus terminal block are so called passive terminals. The passive terminals have no current consumption out of the E-Bus.

To ensure an optimal data transfer, you must not directly string together more than two passive terminals!

Examples for positioning of passive terminals (highlighted)

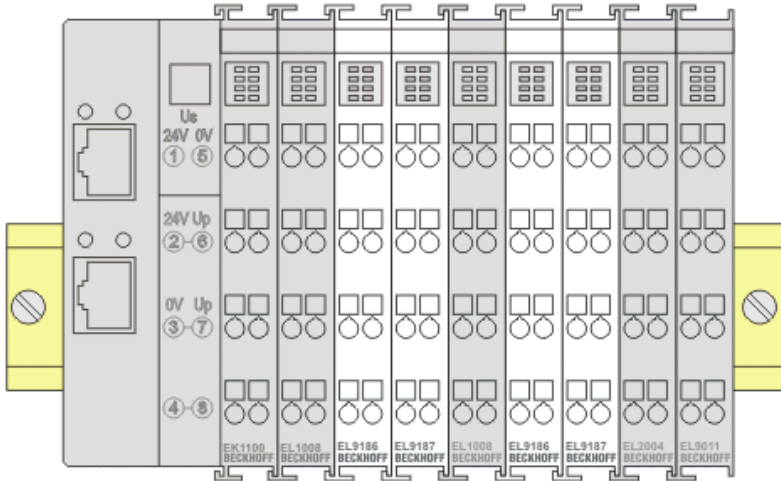

Fig. 78: Correct positioning

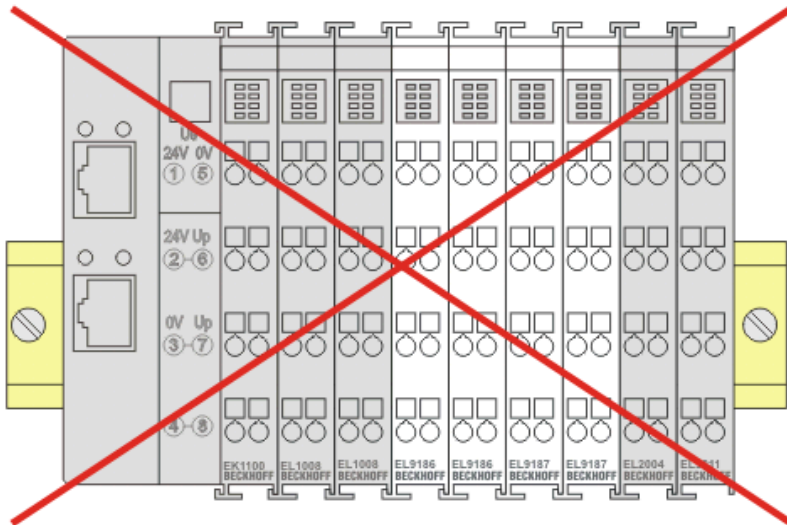

Fig. 79: Incorrect positioning

4.10 Disposal



Products marked with a crossed-out wheeled bin shall not be discarded with the normal waste stream. The device is considered as waste electrical and electronic equipment. The national regulations for the disposal of waste electrical and electronic equipment must be observed.

5 Commissioning

5.1 TwinCAT Quick Start

TwinCAT is a development environment for real-time control including a multi PLC system, NC axis control, programming and operation. The whole system is mapped through this environment and enables access to a programming environment (including compilation) for the controller. Individual digital or analog inputs or outputs can also be read or written directly, in order to verify their functionality, for example.

For further information, please refer to <http://infosys.beckhoff.com>:

- **EtherCAT System Manual:**
Fieldbus Components → EtherCAT Terminals → EtherCAT System Documentation → Setup in the TwinCAT System Manager
- **TwinCAT 2** → TwinCAT System Manager → I/O Configuration
- In particular, for TwinCAT – driver installation:
Fieldbus components → Fieldbus Cards and Switches → FC900x – PCI Cards for Ethernet → Installation

Devices contain the relevant terminals for the actual configuration. All configuration data can be entered directly via editor functions (offline) or via the `scan function (online):

- **“offline”**: The configuration can be customized by adding and positioning individual components. These can be selected from a directory and configured.
 - The procedure for the offline mode can be found under <http://infosys.beckhoff.com>:
TwinCAT 2 → TwinCAT System Manager → IO Configuration → Add an I/O device
- **“online”**: The existing hardware configuration is read
 - See also <http://infosys.beckhoff.com>:
Fieldbus components → Fieldbus Cards and Switches → FC900x – PCI Cards for Ethernet → Installation → Searching for devices

The following relationship is envisaged between the user PC and individual control elements:

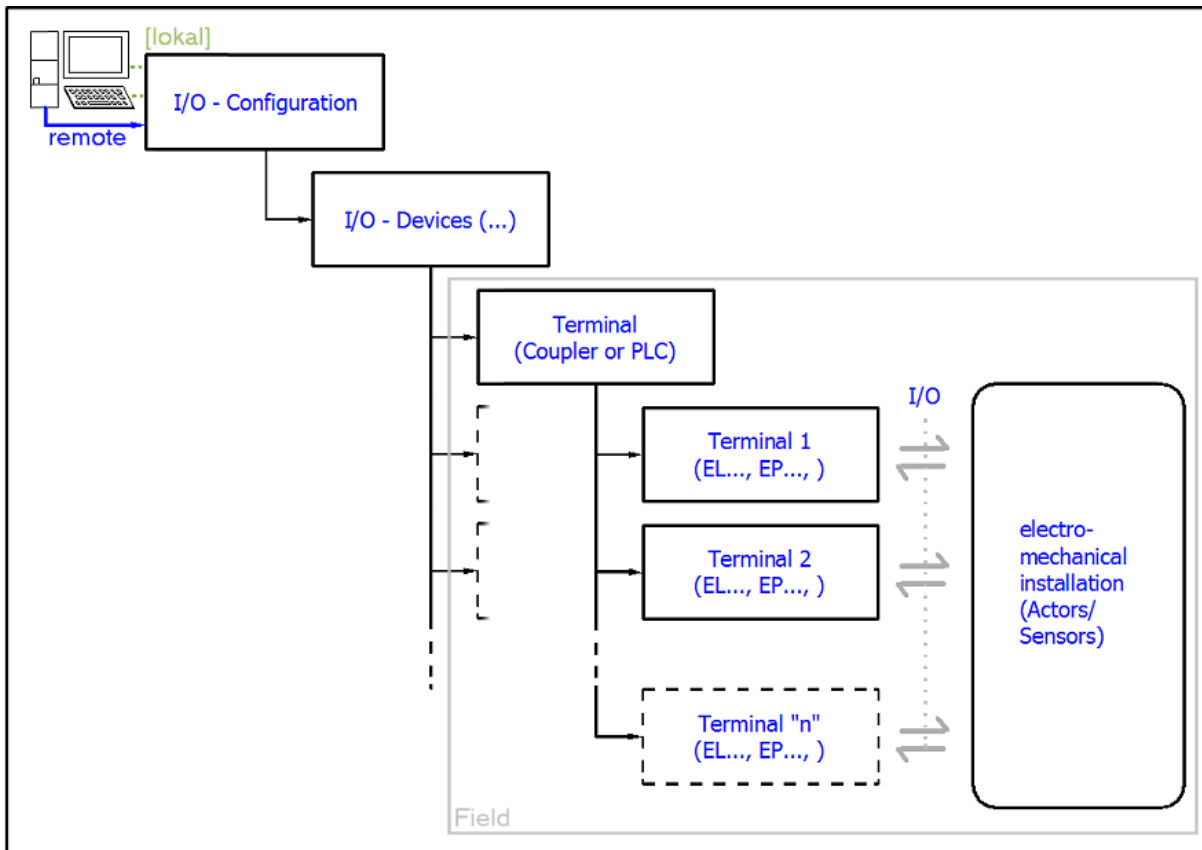

Fig. 80: Relationship between user side (commissioning) and installation

Insertion of certain components (I/O device, terminal, box...) by users functions the same way as in TwinCAT 2 and TwinCAT 3. The descriptions below relate solely to the online procedure.

Example configuration (actual configuration)

Based on the following example configuration, the subsequent subsections describe the procedure for TwinCAT 2 and TwinCAT 3:

- **CX2040** control system (PLC) including **CX2100-0004** power supply unit
- Connected to CX2040 on the right (E-bus):
EL1004 (4-channel digital input terminal 24 V_{DC})
- Linked via the X001 port (RJ-45): **EK1100** EtherCAT Coupler
- Connected to the EK1100 EtherCAT Coupler on the right (E-bus):
EL2008 (8-channel digital output terminal 24 V_{DC}; 0.5 A)
- (Optional via X000: a link to an external PC for the user interface)

5.1.1 TwinCAT 2

Startup

TwinCAT 2 basically uses two user interfaces: the TwinCAT System Manager for communication with the electromechanical components and TwinCAT PLC Control for the development and compilation of a controller. The starting point is the TwinCAT System Manager.

After successful installation of the TwinCAT system on the PC to be used for development, the TwinCAT 2 System Manager displays the following user interface after startup:

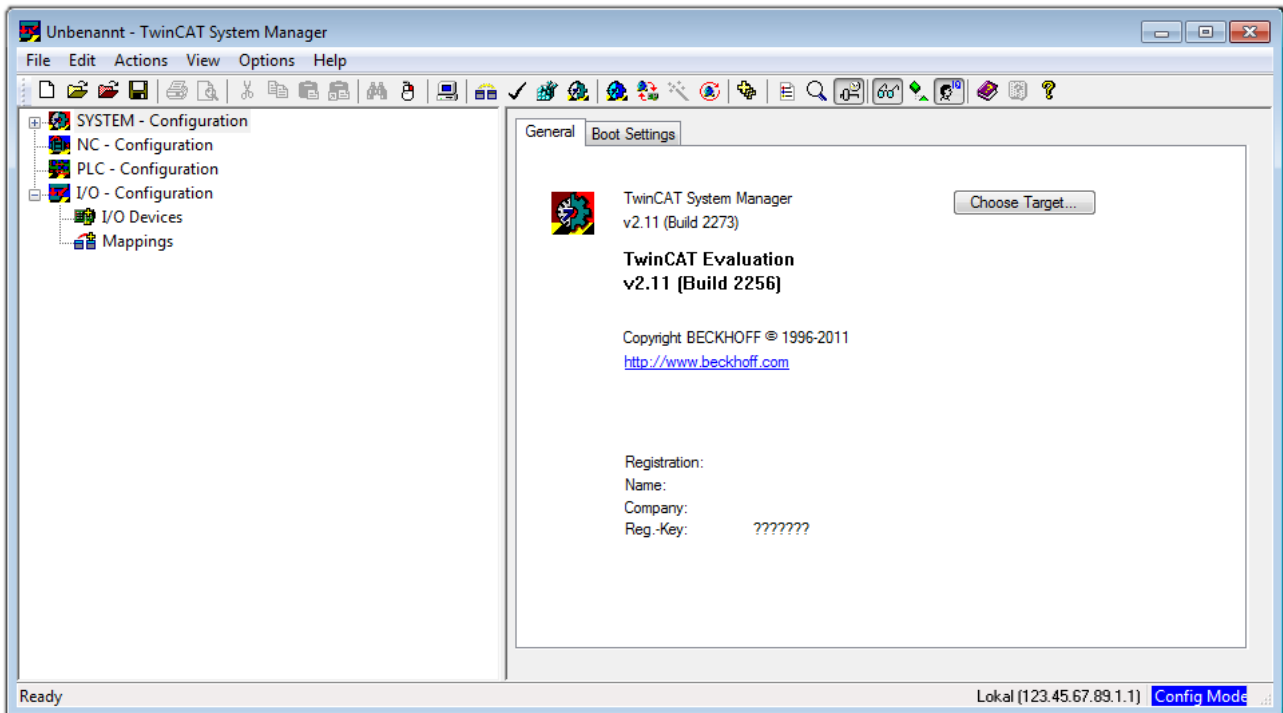



Fig. 82: Initial TwinCAT 2 user interface

Generally, TwinCAT can be used in local or remote mode. Once the TwinCAT system, including the user interface (standard) is installed on the respective PLC, TwinCAT can be used in local mode and thus the next step is “Insert Device [▶ 173]”.

If the intention is to address the TwinCAT runtime environment installed on a PLC remotely from another system used as a development environment, the target system must be made known first. In the menu under

“Actions” → “Choose Target System...”, the following window is opened for this via the symbol “” or the “F8” key:

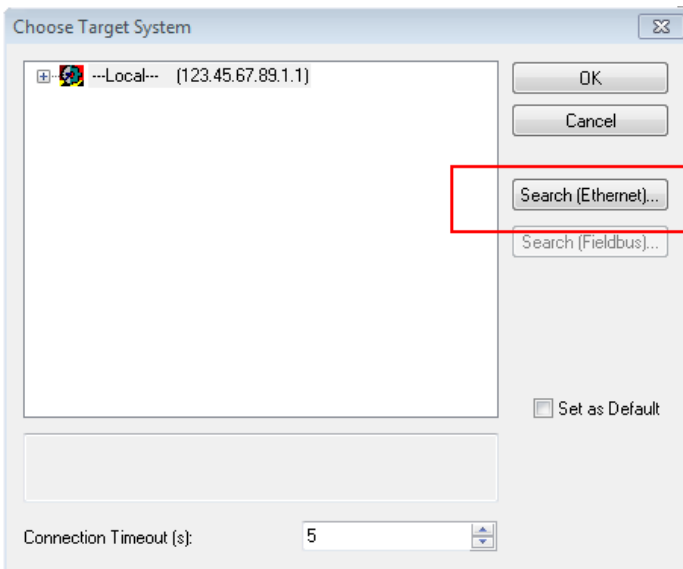

Fig. 83: Selection of the target system

Use “Search (Ethernet)...” to enter the target system. Thus another dialog opens to either:

- enter the known computer name after “Enter Host Name / IP:” (as shown in red)
- perform a “Broadcast Search” (if the exact computer name is not known)
- enter the known computer – IP or AmsNetID

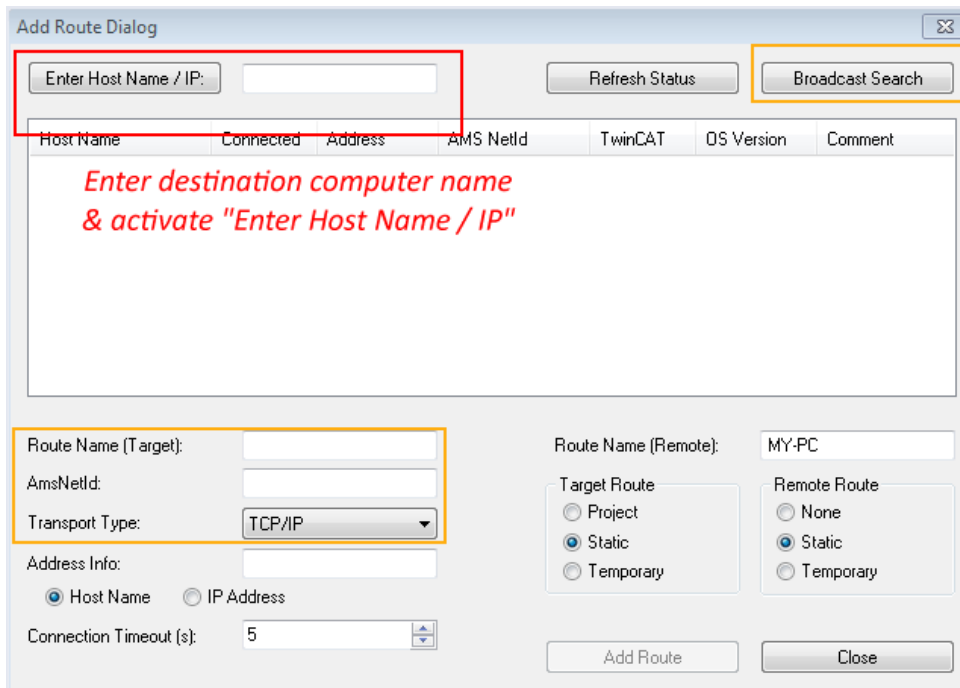
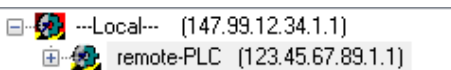

Fig. 84: specify the PLC for access by the TwinCAT System Manager: selection of the target system



Once the target system has been entered, it is available for selection as follows (a correct password may have to be entered before this):



After confirmation with “OK”, the target system can be accessed via the System Manager.

Adding devices

In the configuration tree of the TwinCAT 2 System Manager user interface on the left, select “I/O Devices” and then right-click to open a context menu and select “Scan Devices...”, or start the action in the menu bar

via . The TwinCAT System Manager may first have to be set to “Config Mode” via  or via the menu “Actions” → “Set/Reset TwinCAT to Config Mode...” (Shift + F4).

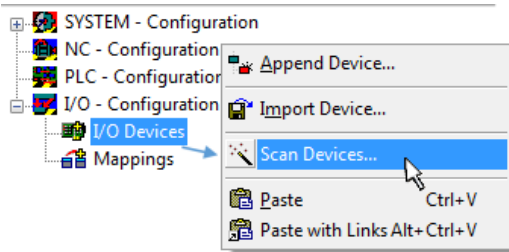

Fig. 85: Select “Scan Devices...”

Confirm the warning message, which follows, and select the “EtherCAT” devices in the dialog:

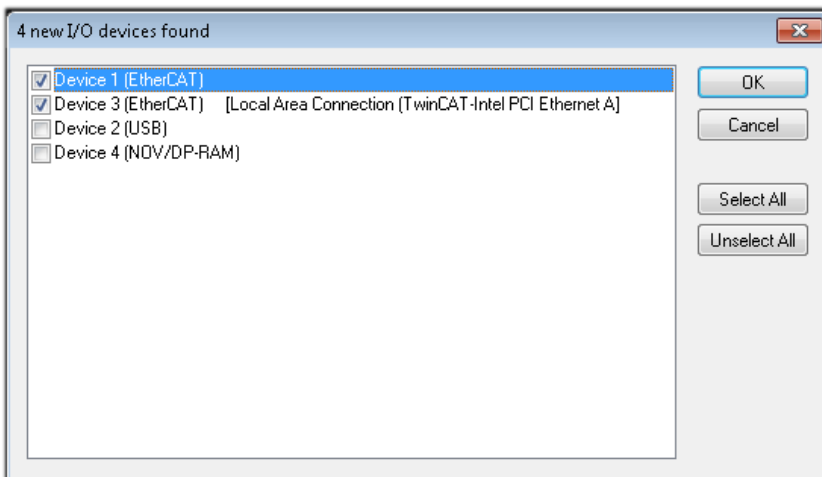

Fig. 86: Automatic detection of I/O devices: selection of the devices to be integrated

Confirm the message “Find new boxes”, in order to determine the terminals connected to the devices. “Free Run” enables manipulation of input and output values in “Config Mode” and should also be acknowledged.

Based on the [example configuration \[▶_169\]](#) described at the beginning of this section, the result is as follows:

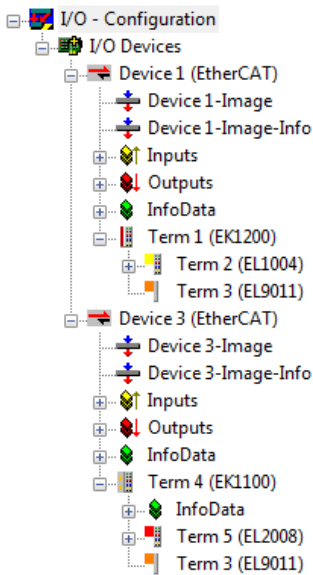

Fig. 87: Mapping of the configuration in the TwinCAT 2 System Manager

The whole process consists of two stages, which can also be performed separately (first determine the devices, then determine the connected elements such as boxes, terminals, etc.). A scan (search function) can also be initiated by selecting “Device ...” from the context menu, which then only reads the elements below which are present in the configuration:

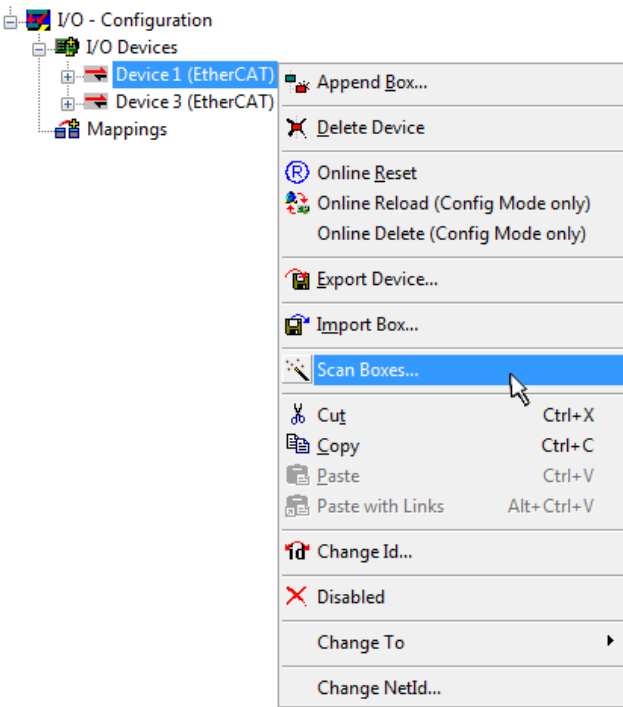

Fig. 88: Reading of individual terminals connected to a device

This functionality is useful if the actual configuration is modified at short notice.

Programming and integrating the PLC

TwinCAT PLC Control is the development environment for generating the controller in different program environments: TwinCAT PLC Control supports all languages described in IEC 61131-3. There are two text-based languages and three graphical languages.

- **Text-based languages**
 - Instruction List (IL)
 - Structured Text (ST)

- **Graphical languages**
 - Function Block Diagram (FBD)
 - Ladder Diagram (LD)
 - The Continuous Function Chart Editor (CFC)
 - Sequential Function Chart (SFC)

The following section refers solely to Structured Text (ST).

After starting TwinCAT PLC Control, the following user interface is shown for an initial project:

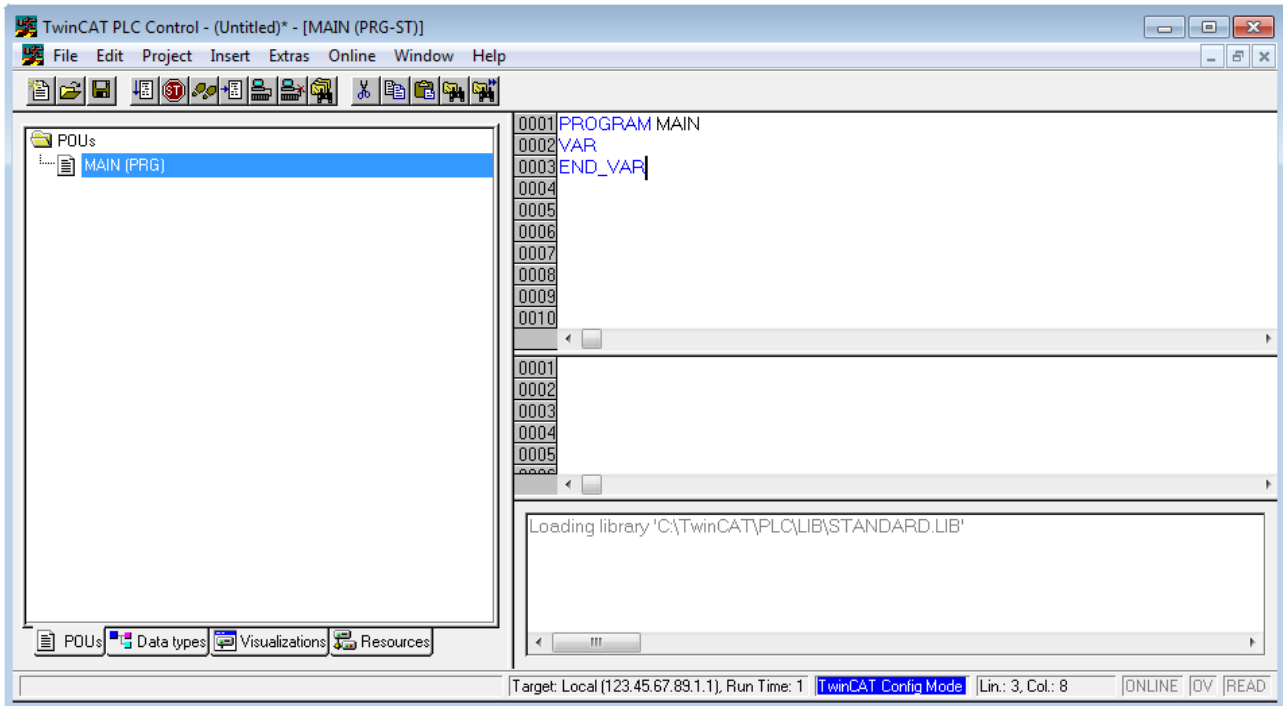

Fig. 89: TwinCAT PLC Control after startup

Example variables and an example program have been created and stored under the name “PLC_example.pro”:

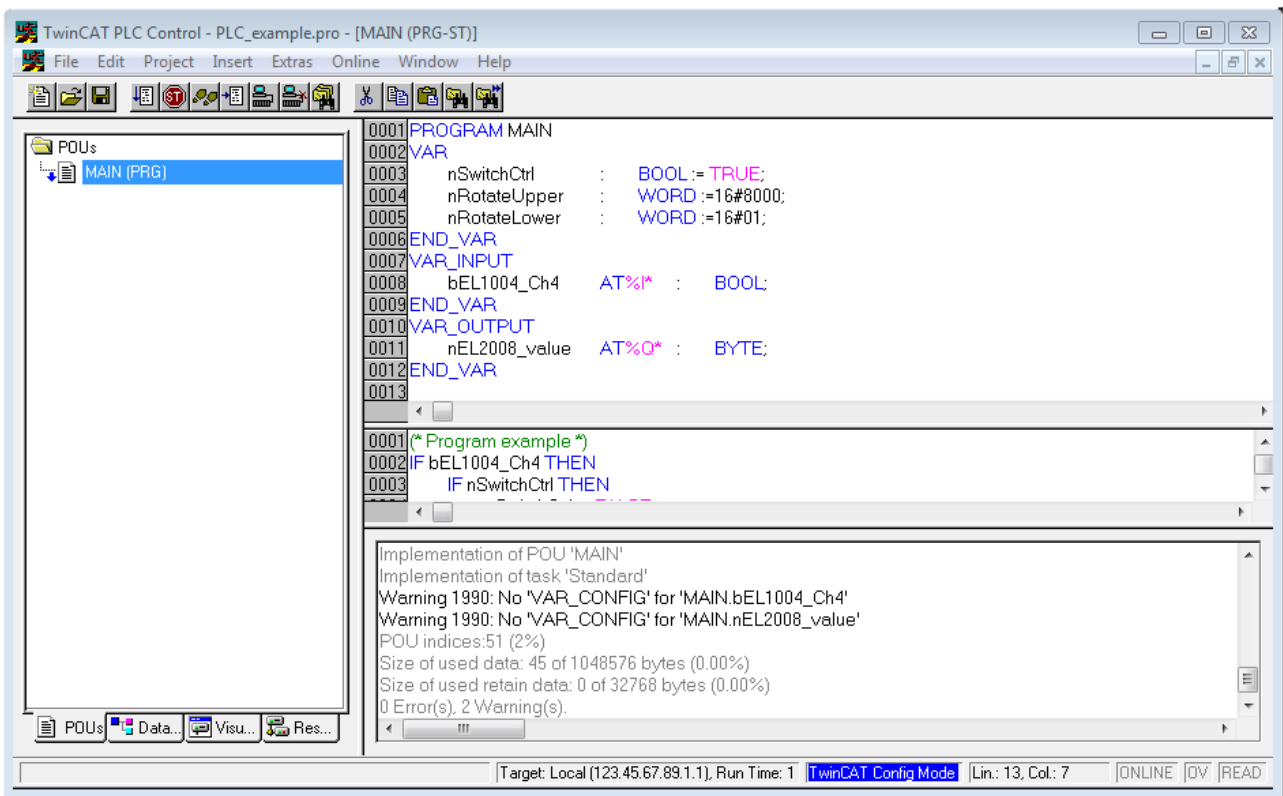

Fig. 90: Example program with variables after a compile process (without variable integration)

Warning 1990 (missing “VAR_CONFIG”) after a compile process indicates that the variables defined as external (with the ID “AT%I*” or “AT%Q*”) have not been assigned. After successful compilation, TwinCAT PLC Control creates a “*.tpy” file in the directory in which the project was stored. This file (“*.tpy”) contains variable assignments and is not known to the System Manager, hence the warning. Once the System Manager has been notified, the warning no longer appears.

First, integrate the TwinCAT PLC Control project in the **System Manager**. This is performed via the context menu of the PLC configuration (right-click) and selecting “Append PLC Project...”:

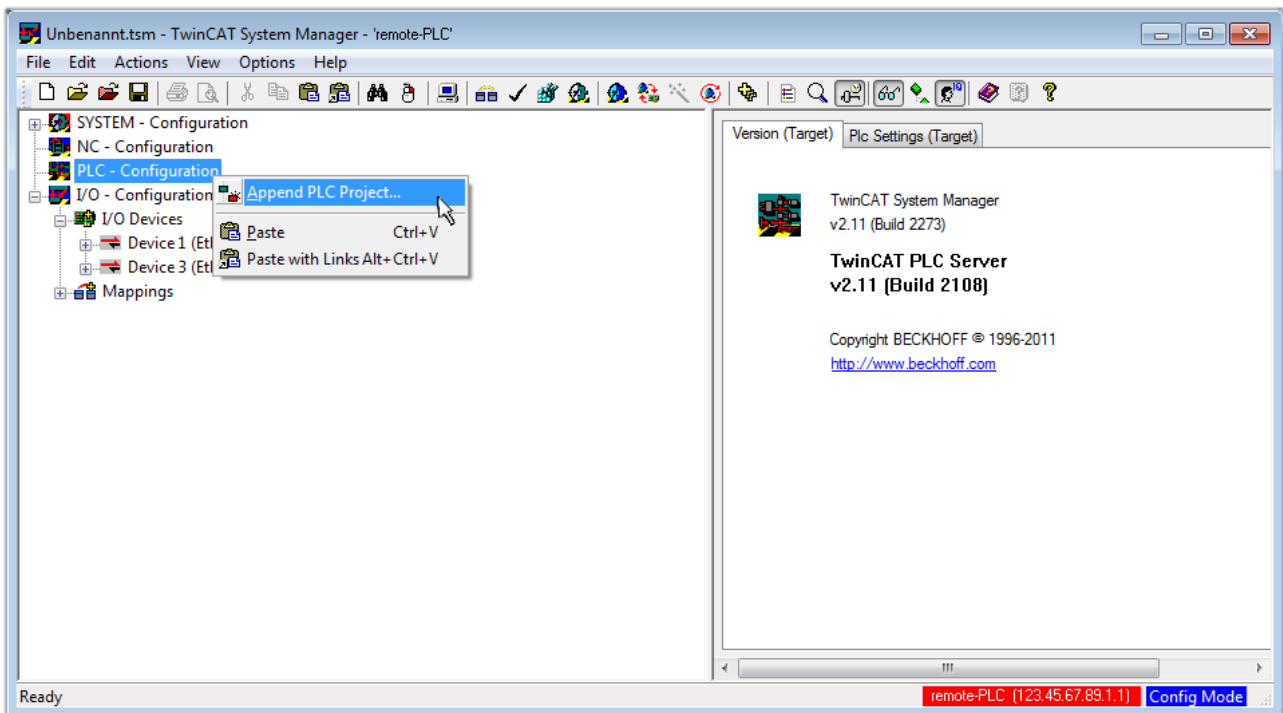

Fig. 91: Appending the TwinCAT PLC Control project

Select the PLC configuration “PLC_example.tpy” in the browser window that opens. The project including the two variables identified with “AT” are then integrated in the configuration tree of the System Manager:

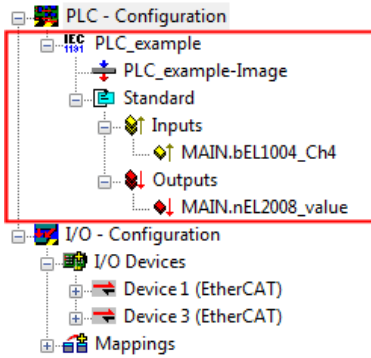

Fig. 92: PLC project integrated in the PLC configuration of the System Manager

The two variables “bEL1004_Ch4” and “nEL2008_value” can now be assigned to certain process objects of the I/O configuration.

Assigning variables

Open a window for selecting a suitable process object (PDO) via the context menu of a variable of the integrated project “PLC_example” and via “Modify Link...” “Standard”:

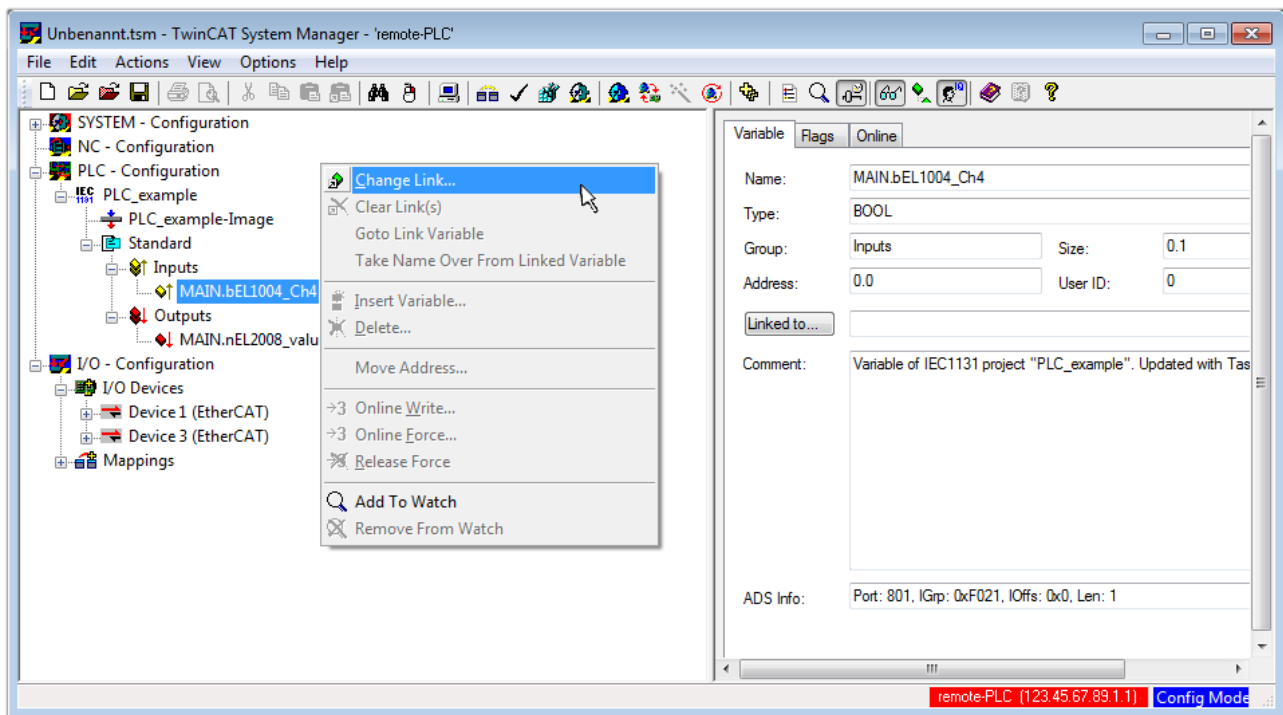

Fig. 93: Creating the links between PLC variables and process objects

In the window that opens, the process object for the “bEL1004_Ch4” BOOL-type variable can be selected from the PLC configuration tree:

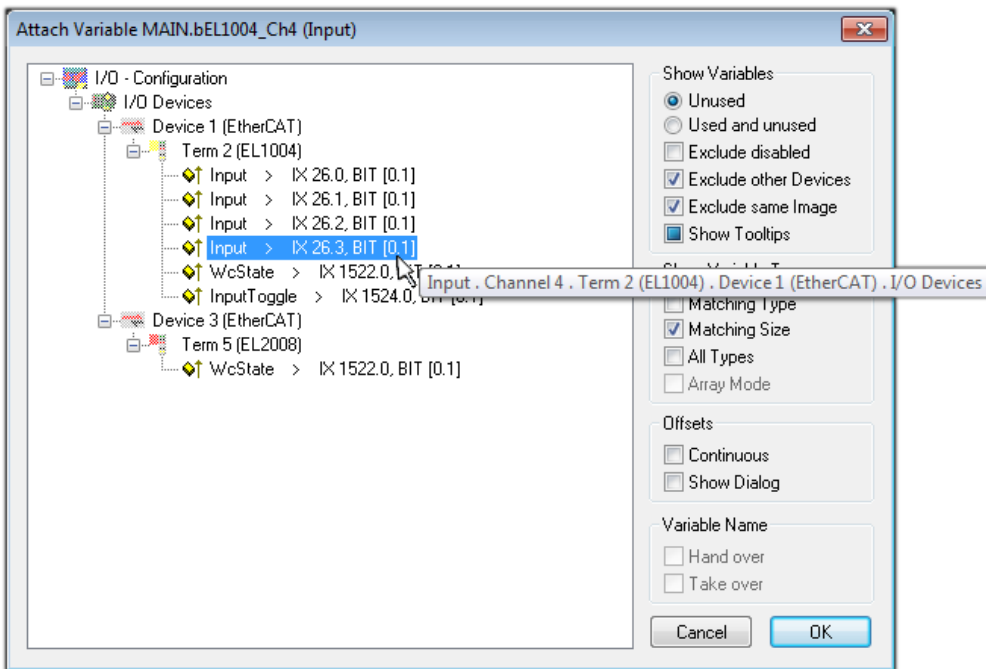

Fig. 94: Selecting BOOL-type PDO

According to the default setting, only certain PDO objects are now available for selection. In this example, the input of channel 4 of the EL1004 terminal is selected for linking. In contrast, the checkbox “All types” must be ticked to create the link for the output variables, in order to allocate a set of eight separate output bits to a byte variable in this case. The following diagram shows the whole process:

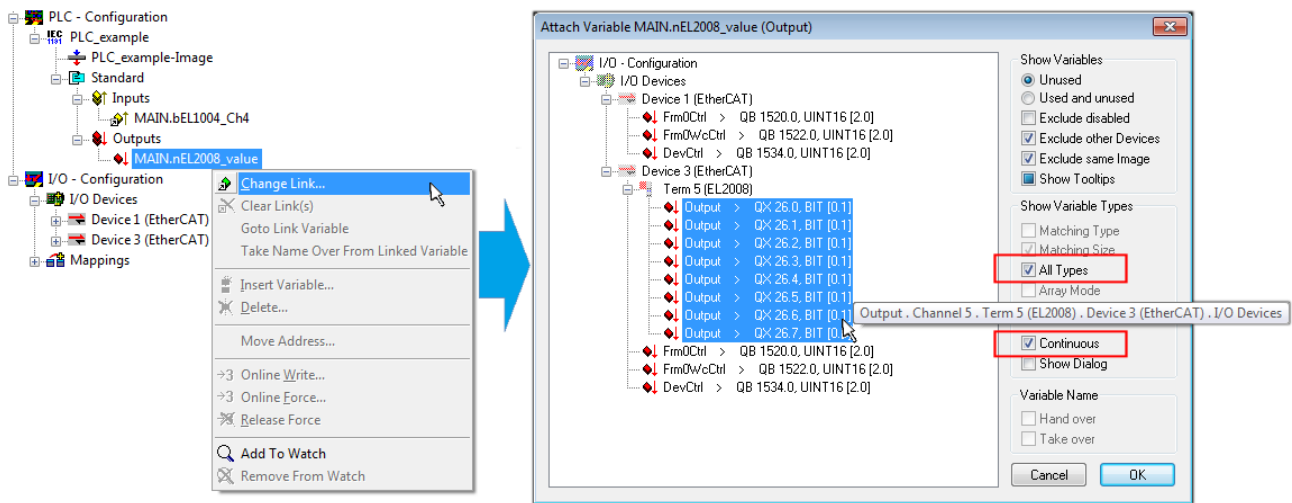



Fig. 95: Selecting several PDOs simultaneously: activate “Continuous” and “All types”

Note that the “Continuous” checkbox was also activated. This is designed to allocate the bits contained in the byte of the “nEL2008_value” variable sequentially to all eight selected output bits of the EL2008 Terminal. It is thus possible to subsequently address all eight outputs of the terminal in the program with a byte corresponding to bit 0 for channel 1 to bit 7 for channel 8 of the PLC. A special symbol () on the yellow or red object of the variable indicates that a link exists. The links can also be checked by selecting “Goto Link Variable” from the context menu of a variable. The opposite linked object, in this case the PDO, is automatically selected:

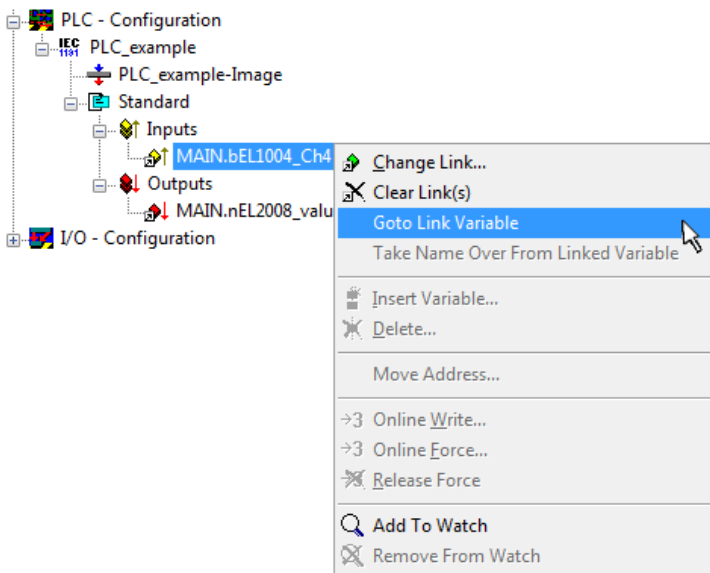

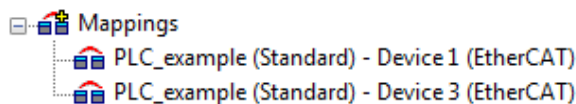

Fig. 96: Application of a “Goto Link Variable”, using “MAIN.bEL1004_Ch4” as an example

The process of assigning variables to the PDO is completed via the menu option “Actions” → “Create assignment”, or via  .

This can be visualized in the configuration:



The process of creating links can also be performed in the opposite direction, i.e. starting with individual PDOs to a variable. However, in this example, it would not be possible to select all output bits for the EL2008, since the terminal only makes individual digital outputs available. If a terminal has a byte, word, integer or similar PDO, it is also possible to allocate this to a set of bit-standardized variables. Here, too, a “Goto Link Variable” can be executed in the other direction, so that the respective PLC instance can then be selected.

Activation of the configuration

The allocation of PDO to PLC variables has now established the connection from the controller to the inputs and outputs of the terminals. The configuration can now be activated. First, the configuration can be verified

via  (or via “Actions” → “Check Configuration”). If no error is present, the configuration can be

activated via  (or via “Actions” → “Activate Configuration...”) to transfer the System Manager settings to the runtime system. Confirm the messages “Old configurations will be overwritten!” and “Restart TwinCAT system in Run mode” with “OK”.

A few seconds later, the real-time status **RTime 0%** is displayed at the bottom right in the System Manager. The PLC system can then be started as described below.

Starting the controller

Starting from a remote system, the PLC control has to be linked with the embedded PC over the Ethernet via “Online” → “Choose Runtime System...”:

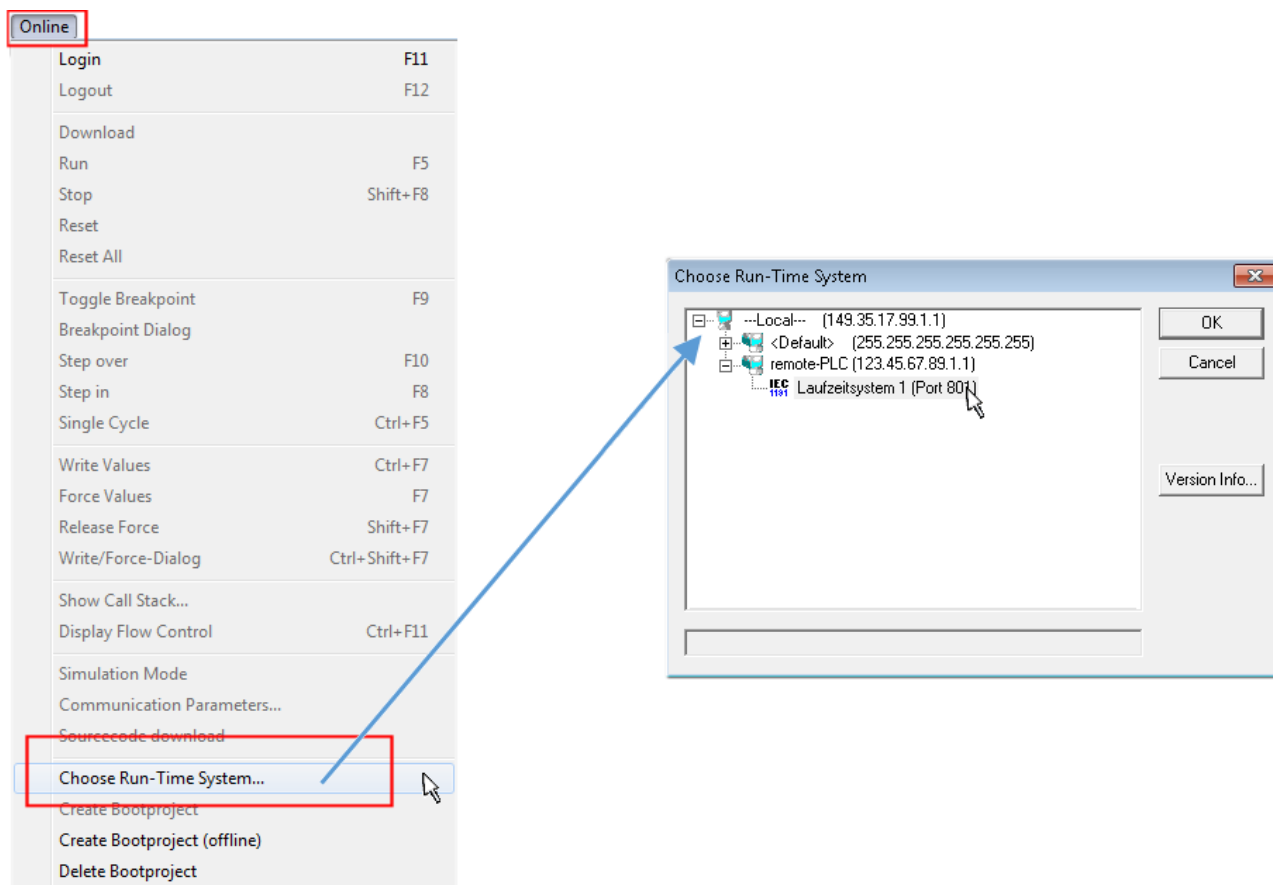



Fig. 97: Choose target system (remote)

In this example, "Runtime system 1 (port 801)" is selected and confirmed. Link the PLC with the real-time

system via the menu option "Online" → "Login", the F11 key or by clicking on the symbol . The control program can then be loaded for execution. This results in the message "No program on the controller! Should the new program be loaded?", which should be confirmed with "Yes". The runtime environment is ready for the program start:

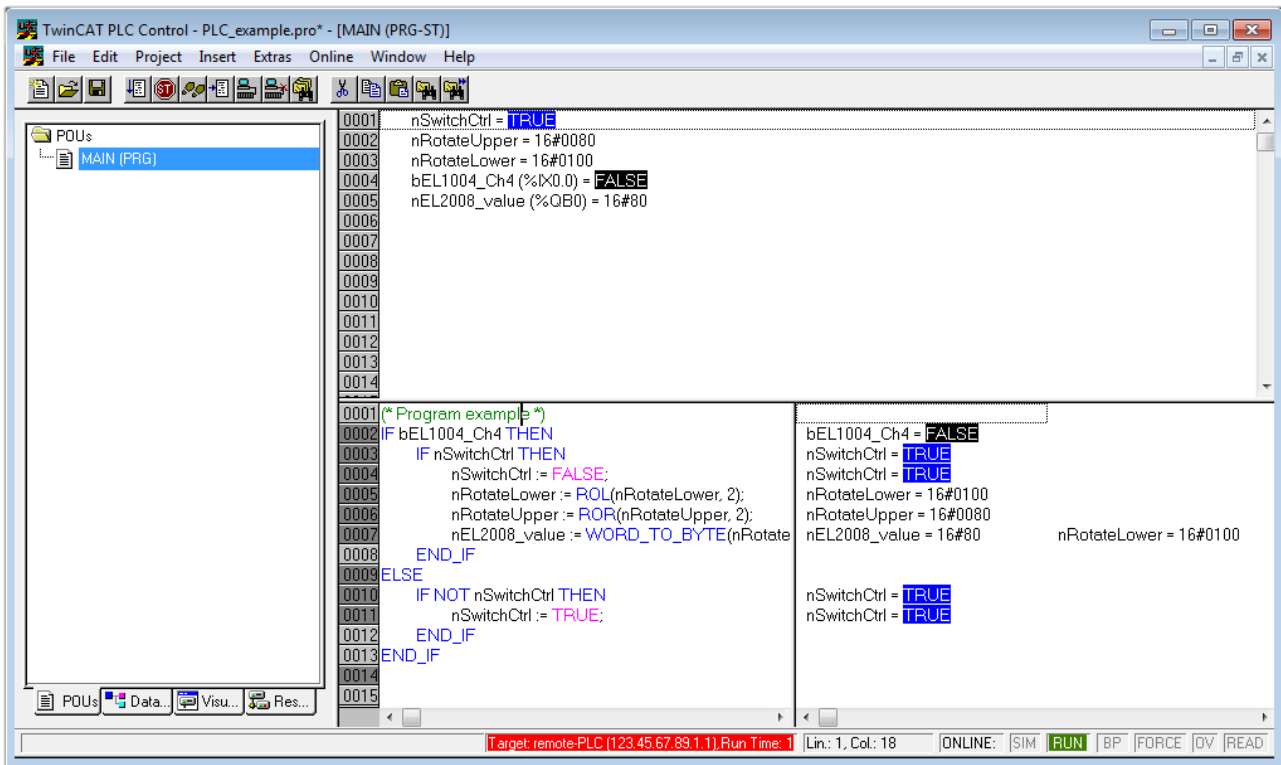

Fig. 98: PLC Control logged in, ready for program startup

The PLC can now be started via “Online” → “Run”, F5 key or .

5.1.2 TwinCAT 3

Startup

TwinCAT 3 makes the development environment areas available all together, with Microsoft Visual Studio: after startup, the project folder explorer appears on the left in the general window area (see “TwinCAT System Manager” of TwinCAT 2) for communication with the electromechanical components.

After successful installation of the TwinCAT system on the PC to be used for development, TwinCAT 3 (shell) displays the following user interface after startup:



Fig. 99: Initial TwinCAT 3 user interface

First create a new project via  **New TwinCAT Project...** (or under “File”→“New”→“Project...”). In the following dialog, make the corresponding entries as required (as shown in the diagram):

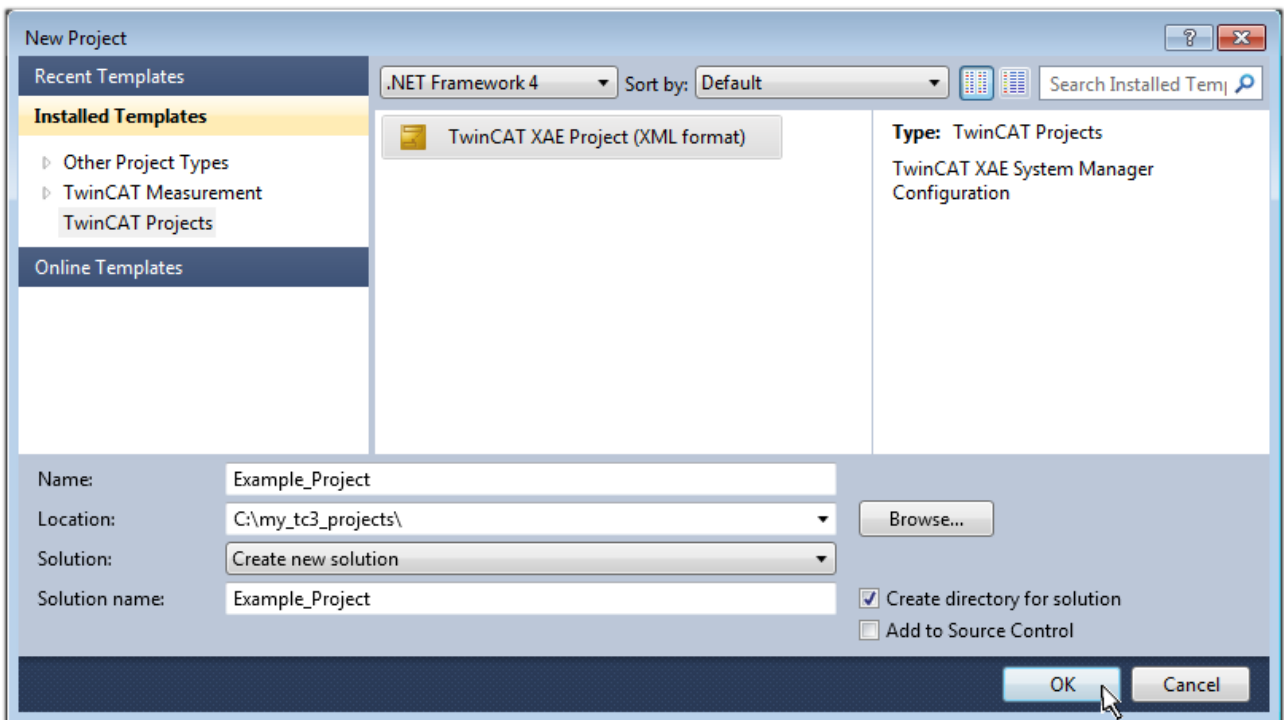

Fig. 100: Create new TwinCAT 3 project

The new project is then available in the project folder explorer:

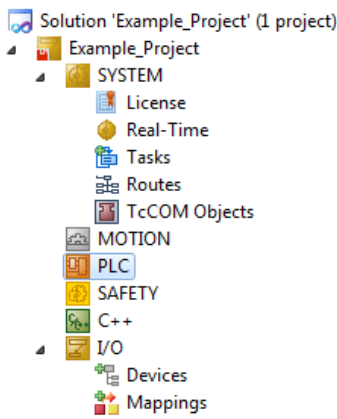
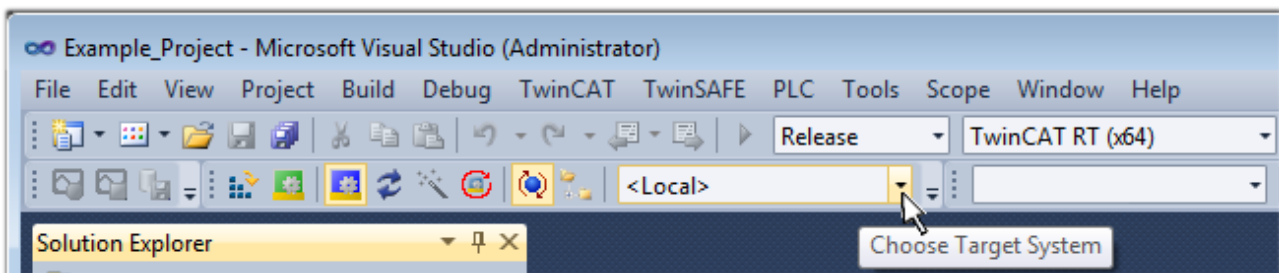

Fig. 101: New TwinCAT 3 project in the project folder explorer

Generally, TwinCAT can be used in local or remote mode. Once the TwinCAT system including the user interface (standard) is installed on the respective PLC (locally), TwinCAT can be used in local mode and the process can be continued with the next step, “Insert Device [► 184]”.

If the intention is to address the TwinCAT runtime environment installed on a PLC remotely from another system used as a development environment, the target system must be made known first. Via the symbol in the menu bar:



expand the pull-down menu:

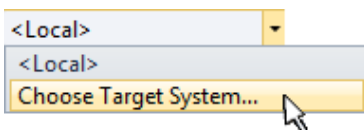

and open the following window:

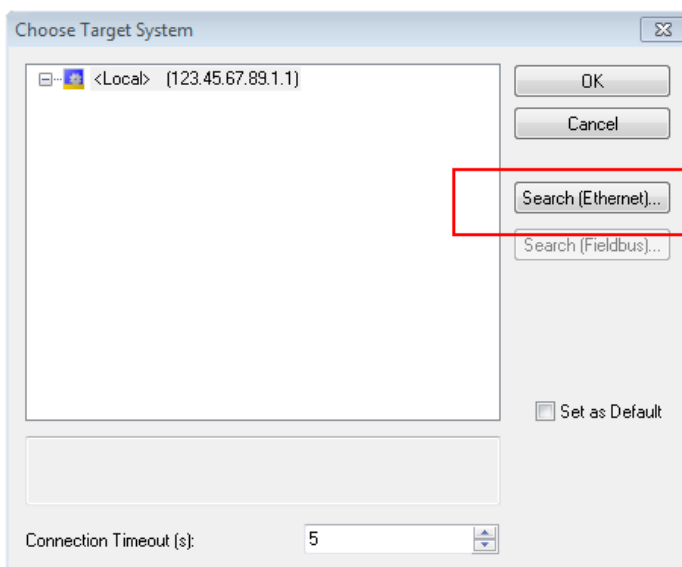

Fig. 102: Selection dialog: Choose the target system

Use “Search (Ethernet)...” to enter the target system. Thus another dialog opens to either:

- enter the known computer name after “Enter Host Name / IP:” (as shown in red)
- perform a “Broadcast Search” (if the exact computer name is not known)
- enter the known computer – IP or AmsNetID

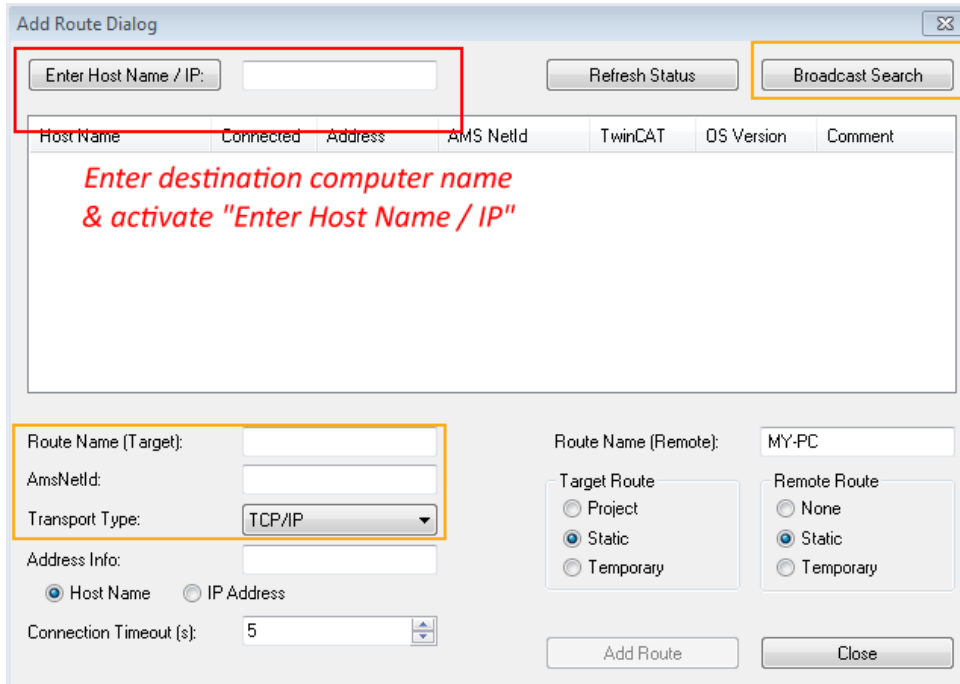
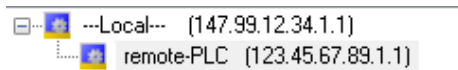

Fig. 103: specify the PLC for access by the TwinCAT System Manager: selection of the target system

Once the target system has been entered, it is available for selection as follows (the correct password may have to be entered beforehand):



After confirmation with “OK” the target system can be accessed via the Visual Studio shell.

Adding devices

In the project folder explorer on the left of the Visual Studio shell user interface, select “Devices” within the

element “I/O”, then right-click to open a context menu and select “Scan” or start the action via  in the

menu bar. The TwinCAT System Manager may first have to be set to “Config mode” via  or via the menu “TwinCAT” → “Restart TwinCAT (Config Mode)”.

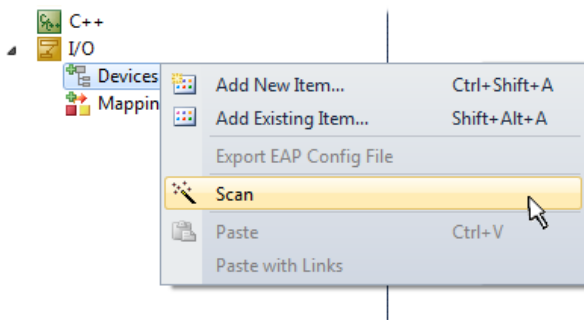

Fig. 104: Select “Scan”

Confirm the warning message, which follows, and select the “EtherCAT” devices in the dialog:

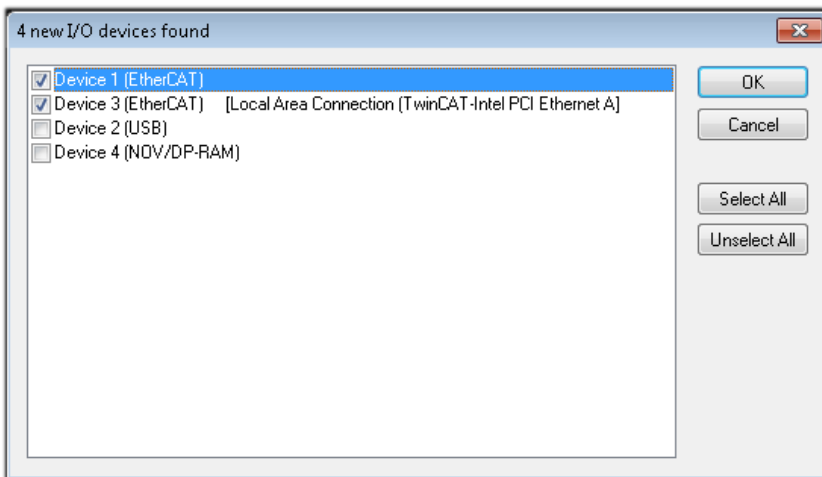

Fig. 105: Automatic detection of I/O devices: selection of the devices to be integrated

Confirm the message “Find new boxes”, in order to determine the terminals connected to the devices. “Free Run” enables manipulation of input and output values in “Config Mode” and should also be acknowledged.

Based on the [example configuration \[▶ 169\]](#) described at the beginning of this section, the result is as follows:

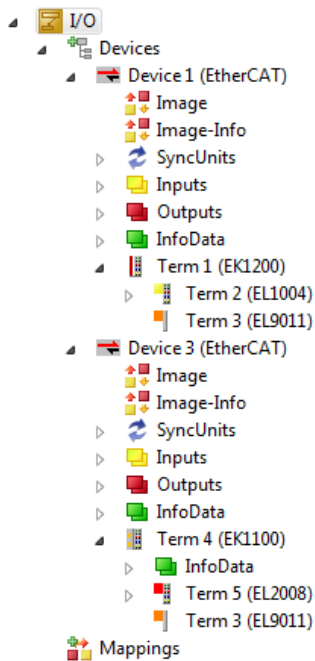

Fig. 106: Mapping of the configuration in VS shell of the TwinCAT 3 environment

The whole process consists of two stages, which can also be performed separately (first determine the devices, then determine the connected elements such as boxes, terminals, etc.). A scan (search function) can also be initiated by selecting “Device ...” from the context menu, which then only reads the elements below which are present in the configuration:

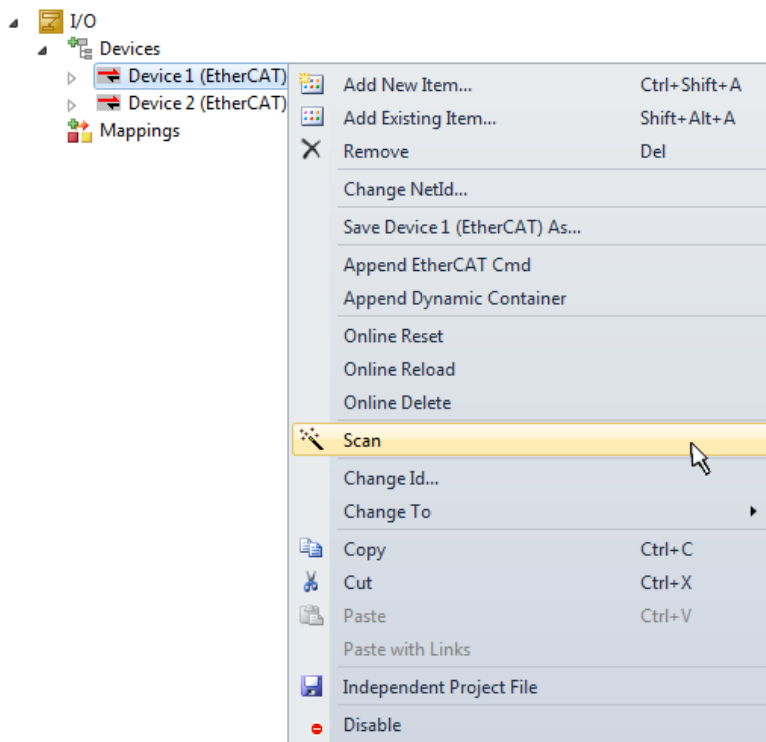

Fig. 107: Reading of individual terminals connected to a device

This functionality is useful if the actual configuration is modified at short notice.

Programming the PLC

TwinCAT PLC Control is the development environment for generating the controller in different program environments: TwinCAT PLC Control supports all languages described in IEC 61131-3. There are two text-based languages and three graphical languages.

- **Text-based languages**
 - Instruction List (IL)
 - Structured Text (ST)
- **Graphical languages**
 - Function Block Diagram (FBD)
 - Ladder Diagram (LD)
 - The Continuous Function Chart Editor (CFC)
 - Sequential Function Chart (SFC)

The following section refers solely to Structured Text (ST).

In order to create a programming environment, a PLC subproject is added to the example project via the context menu of the "PLC" in the project folder explorer by selecting "Add New Item....":

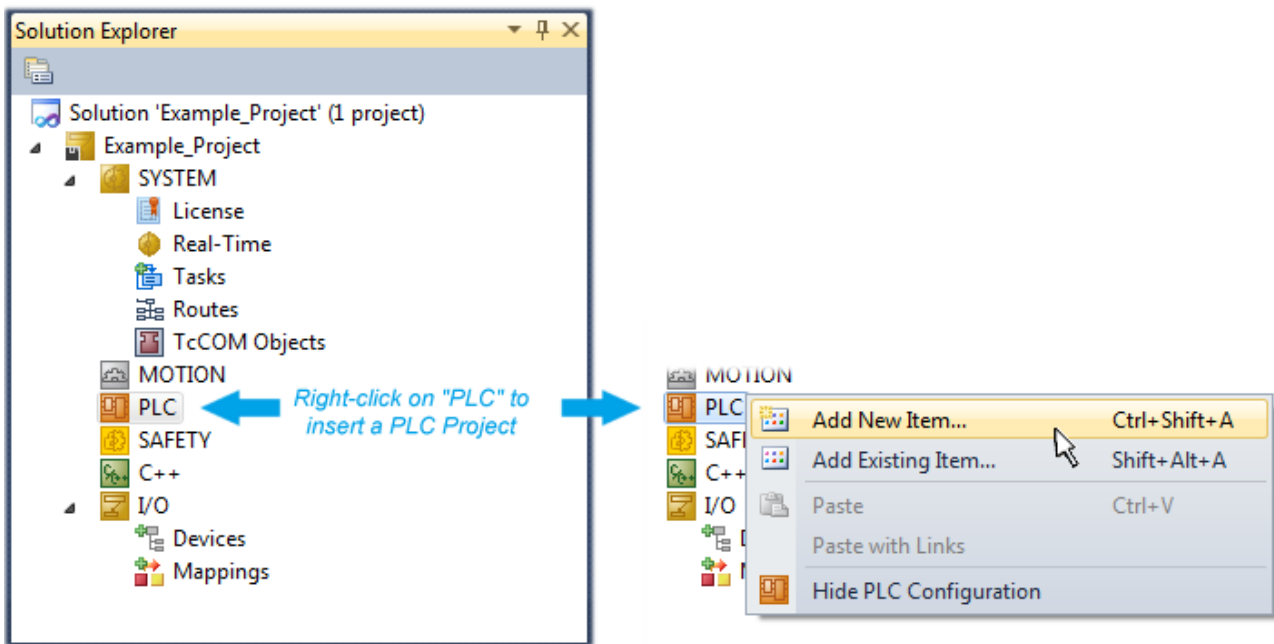

Fig. 108: Adding the programming environment in “PLC”

In the dialog that opens, select “Standard PLC project” and enter “PLC_example” as project name, for example, and select a corresponding directory:

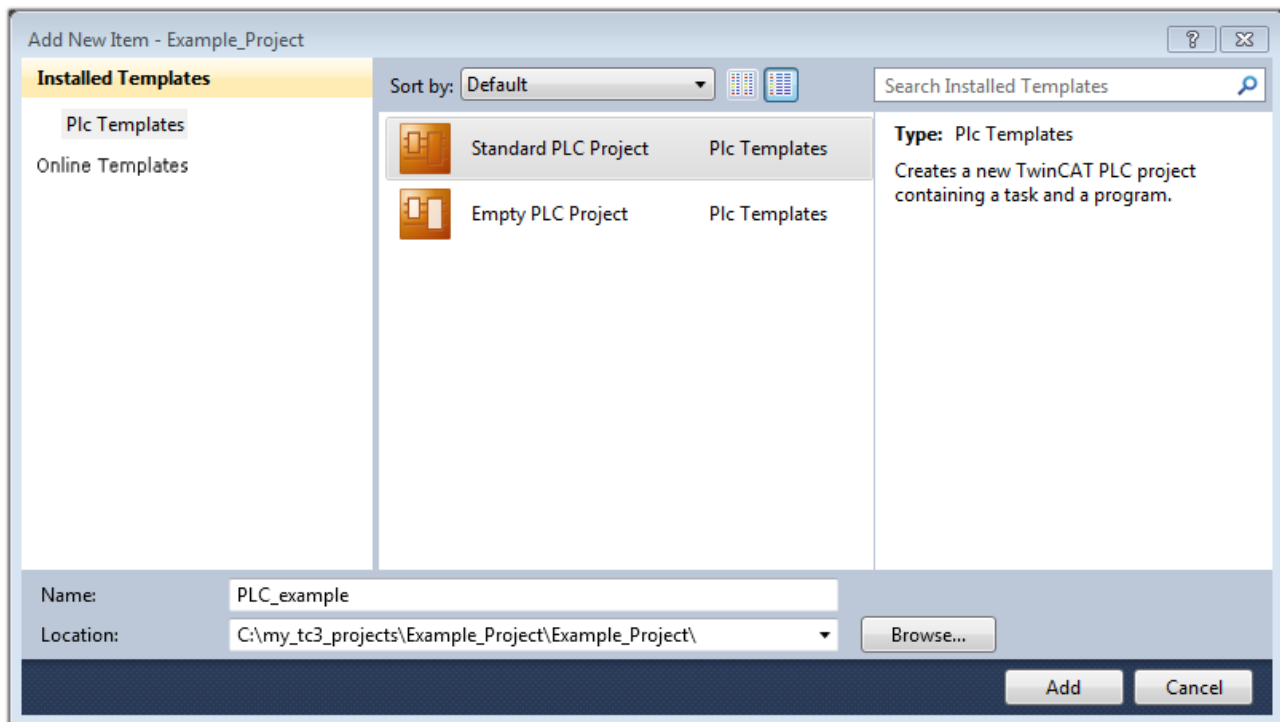

Fig. 109: Specifying the name and directory for the PLC programming environment

The “Main” program, which already exists due to selecting “Standard PLC project”, can be opened by double-clicking on “PLC_example_project” in “POUs”. The following user interface is shown for an initial project:

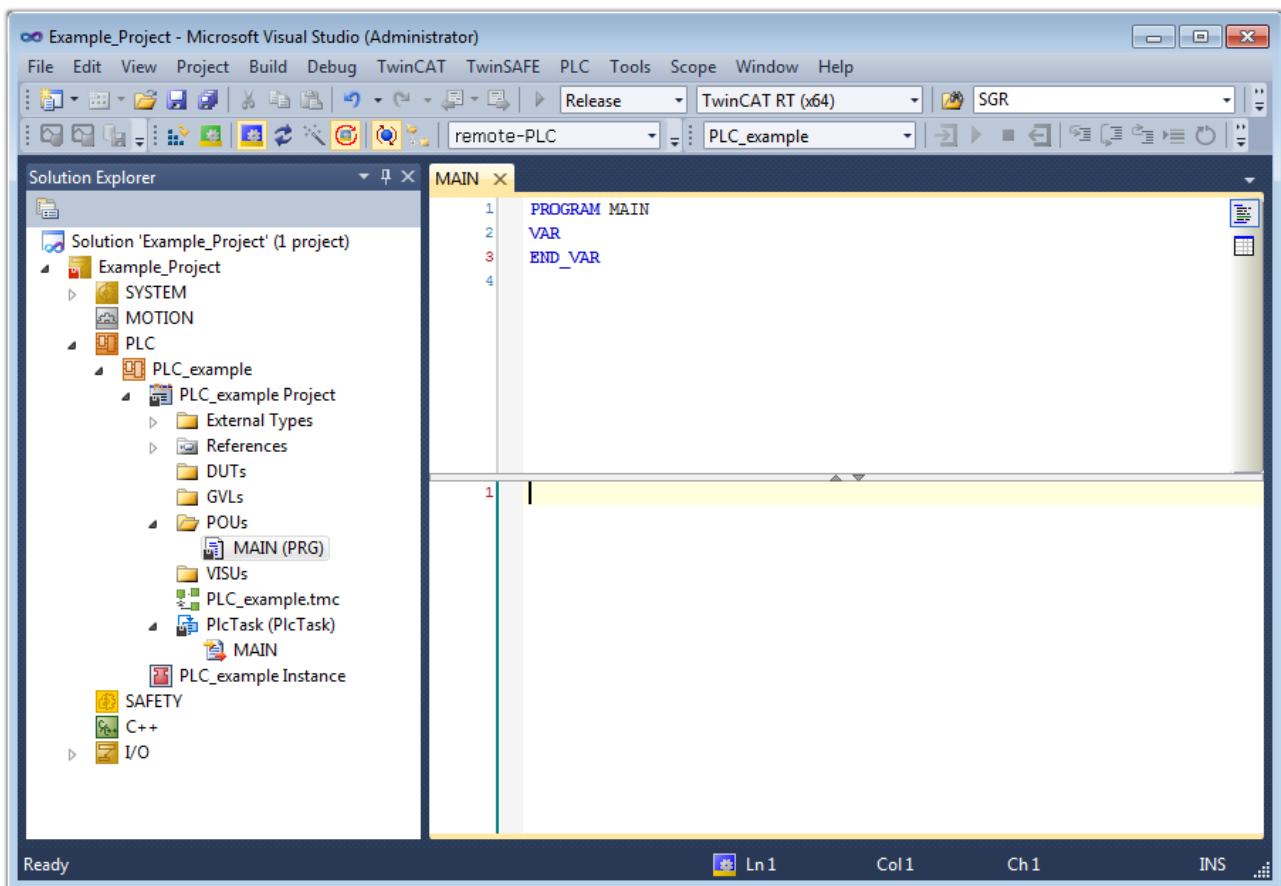

Fig. 110: Initial “Main” program for the standard PLC project

Now example variables and an example program have been created for the next stage of the process:

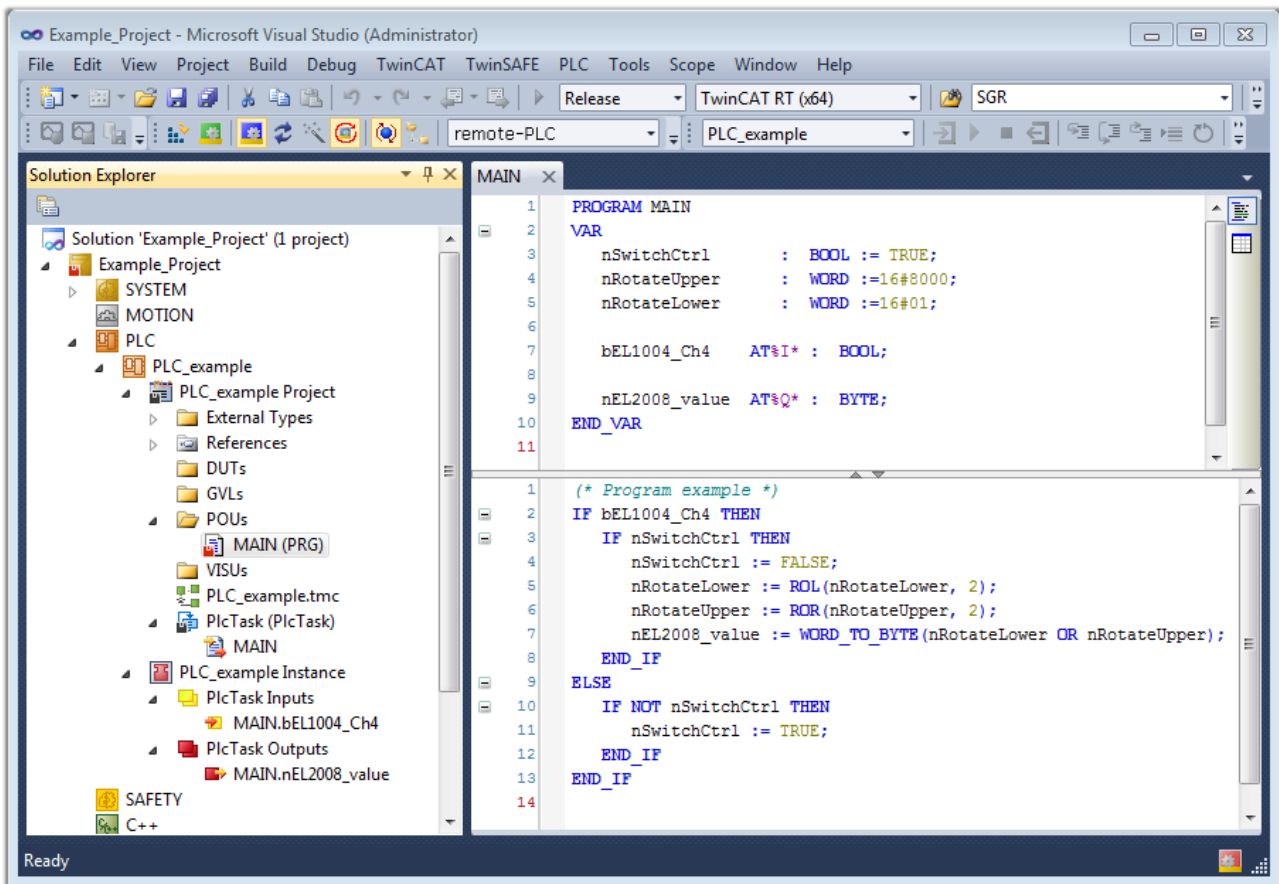

Fig. 111: Example program with variables after a compile process (without variable integration)

The control program is now created as a project folder, followed by the compile process:

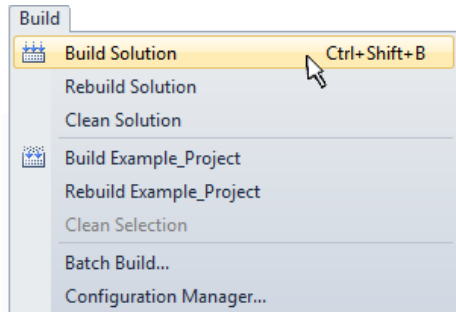
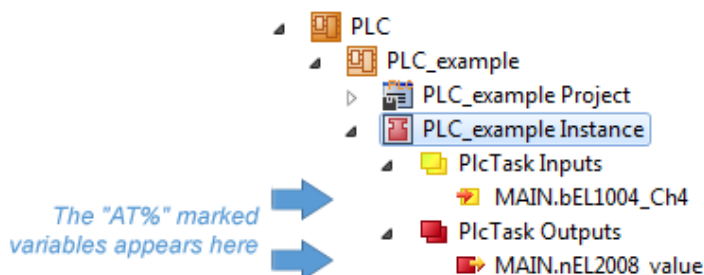

Fig. 112: Start program compilation

The following variables, identified in the ST/PLC program with “AT%”, are then available under “Assignments” in the project folder explorer:



Assigning variables

Via the menu of an instance – variables in the “PLC” context, use the “Modify Link...” option to open a window to select a suitable process object (PDO) for linking:

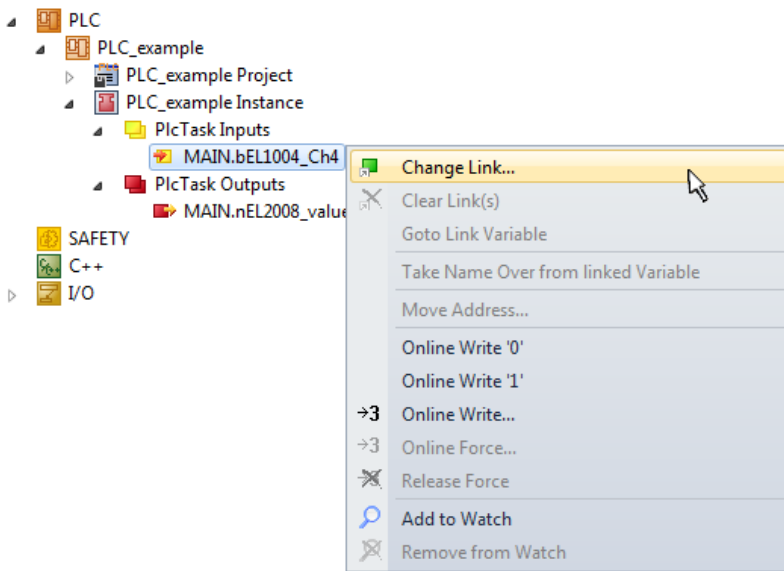

Fig. 113: Creating the links between PLC variables and process objects

In the window that opens, the process object for the “bEL1004_Ch4” BOOL-type variable can be selected from the PLC configuration tree:

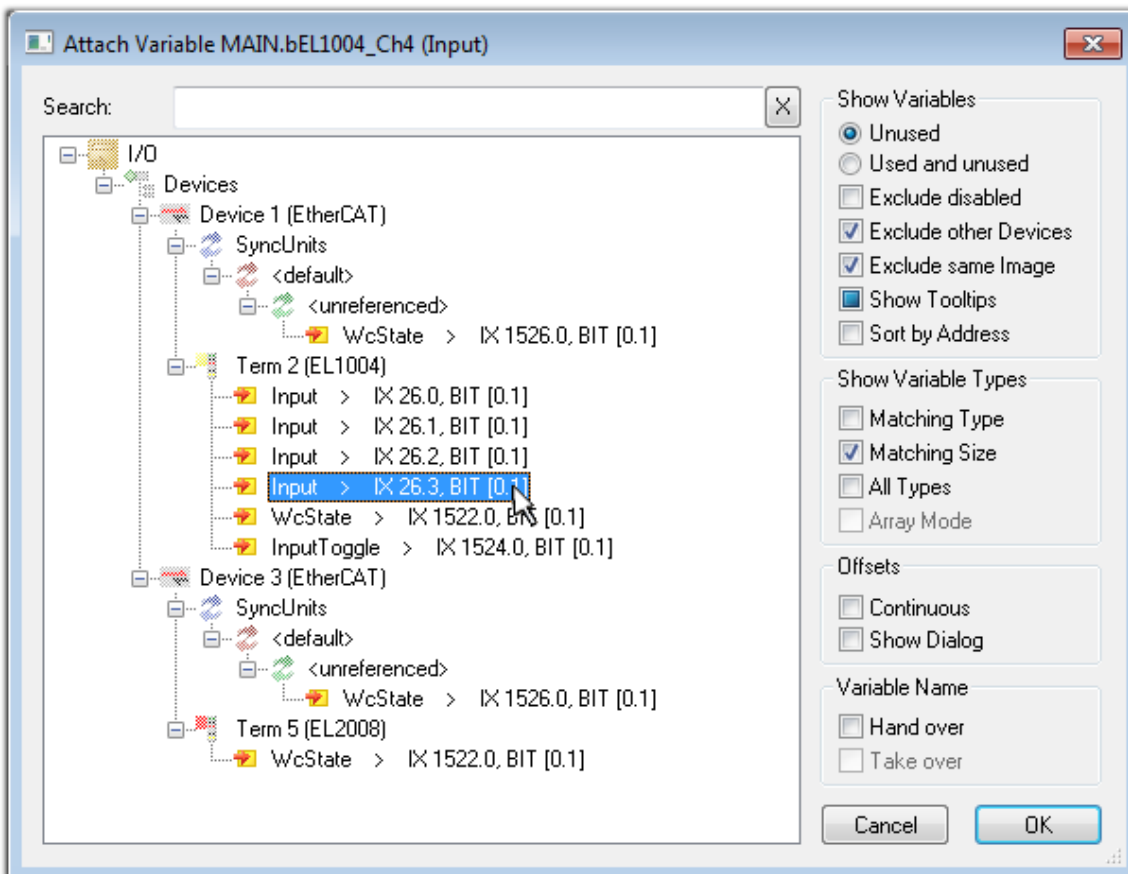

Fig. 114: Selecting BOOL-type PDO

According to the default setting, only certain PDO objects are now available for selection. In this example, the input of channel 4 of the EL1004 terminal is selected for linking. In contrast, the checkbox “All types” must be ticked to create the link for the output variables, in order to allocate a set of eight separate output bits to a byte variable in this case. The following diagram shows the whole process:

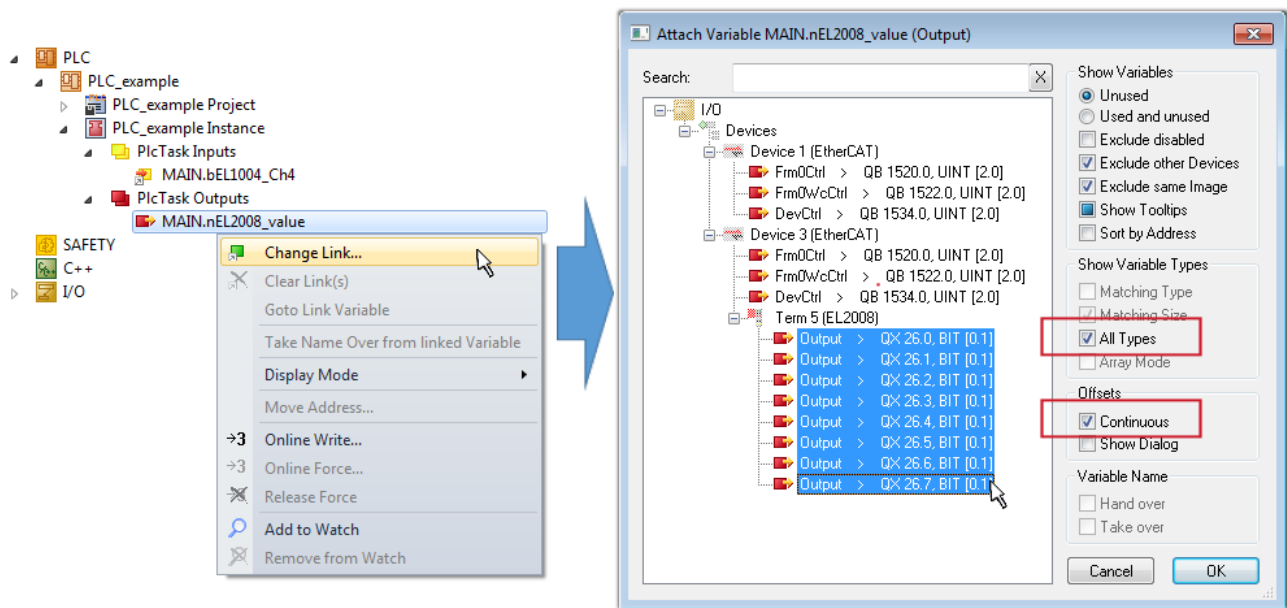



Fig. 115: Selecting several PDOs simultaneously: activate “Continuous” and “All types”

Note that the “Continuous” checkbox was also activated. This is designed to allocate the bits contained in the byte of the “nEL2008_value” variable sequentially to all eight selected output bits of the EL2008 Terminal. It is thus possible to subsequently address all eight outputs of the terminal in the program with a byte corresponding to bit 0 for channel 1 to bit 7 for channel 8 of the PLC. A special symbol () on the yellow or red object of the variable indicates that a link exists. The links can also be checked by selecting “Goto Link Variable” from the context menu of a variable. The opposite linked object, in this case the PDO, is automatically selected:

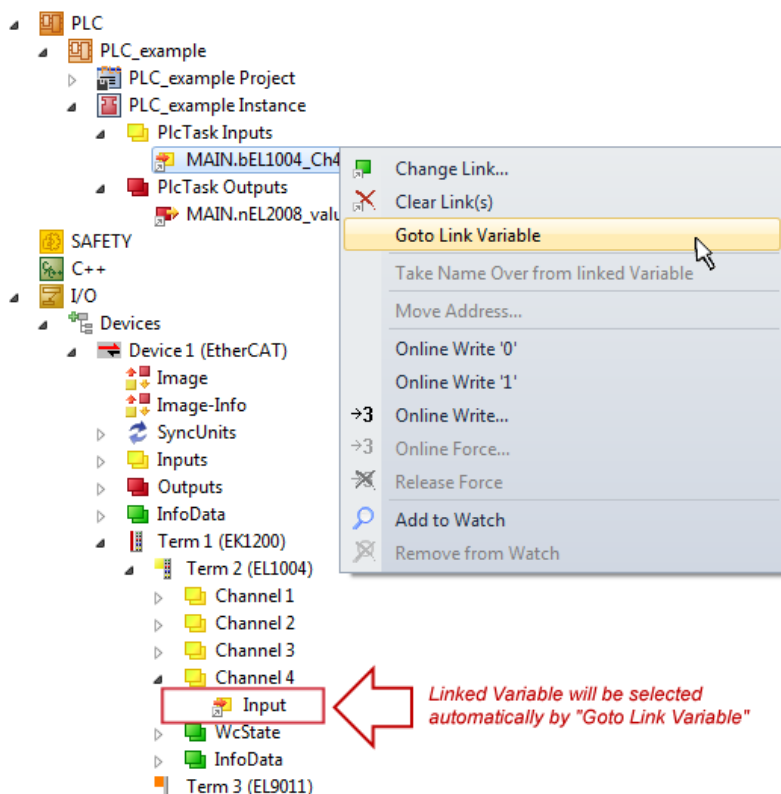

Fig. 116: Application of a “Goto Link Variable”, using “MAIN.bEL1004_Ch4” as an example

The process of creating links can also be performed in the opposite direction, i.e. starting with individual PDOs to a variable. However, in this example, it would not be possible to select all output bits for the EL2008, since the terminal only makes individual digital outputs available. If a terminal has a byte, word,

integer or similar PDO, it is also possible to allocate this to a set of bit-standardized variables. Here, too, a “Goto Link Variable” can be executed in the other direction, so that the respective PLC instance can then be selected.

● Note on type of variable assignment



The following type of variable assignment can only be used from TwinCAT version V3.1.4024.4 onwards and is only available for terminals with a microcontroller.

In TwinCAT, a structure can be created from the mapped process data of a terminal. An instance of this structure can then be created in the PLC, so it is possible to access the process data directly from the PLC without having to declare own variables.

The procedure for the EL3001 1-channel analog input terminal -10...+10 V is shown as an example.

1. First, the required process data must be selected in the “Process data” tab in TwinCAT.
2. After that, the PLC data type must be generated in the “PLC” tab via the check box.
3. The data type in the “Data Type” field can then be copied using the “Copy” button.

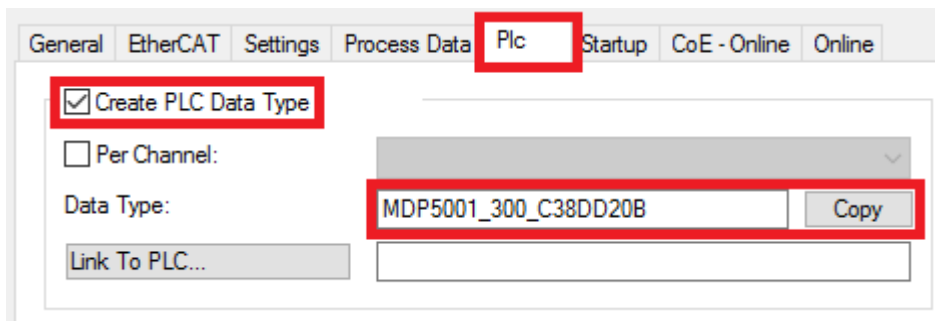

Fig. 117: Creating a PLC data type

4. An instance of the data structure of the copied data type must then be created in the PLC.

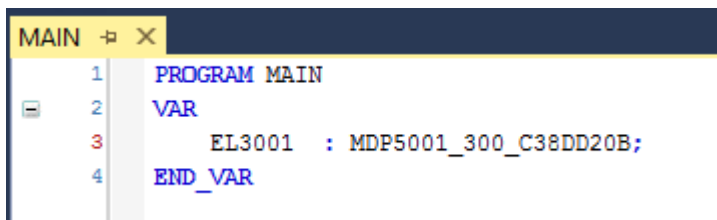

Fig. 118: Instance_of_struct

5. Then the project folder must be created. This can be done either via the key combination “CTRL + Shift + B” or via the “Build” tab in TwinCAT.
6. The structure in the “PLC” tab of the terminal must then be linked to the created instance.

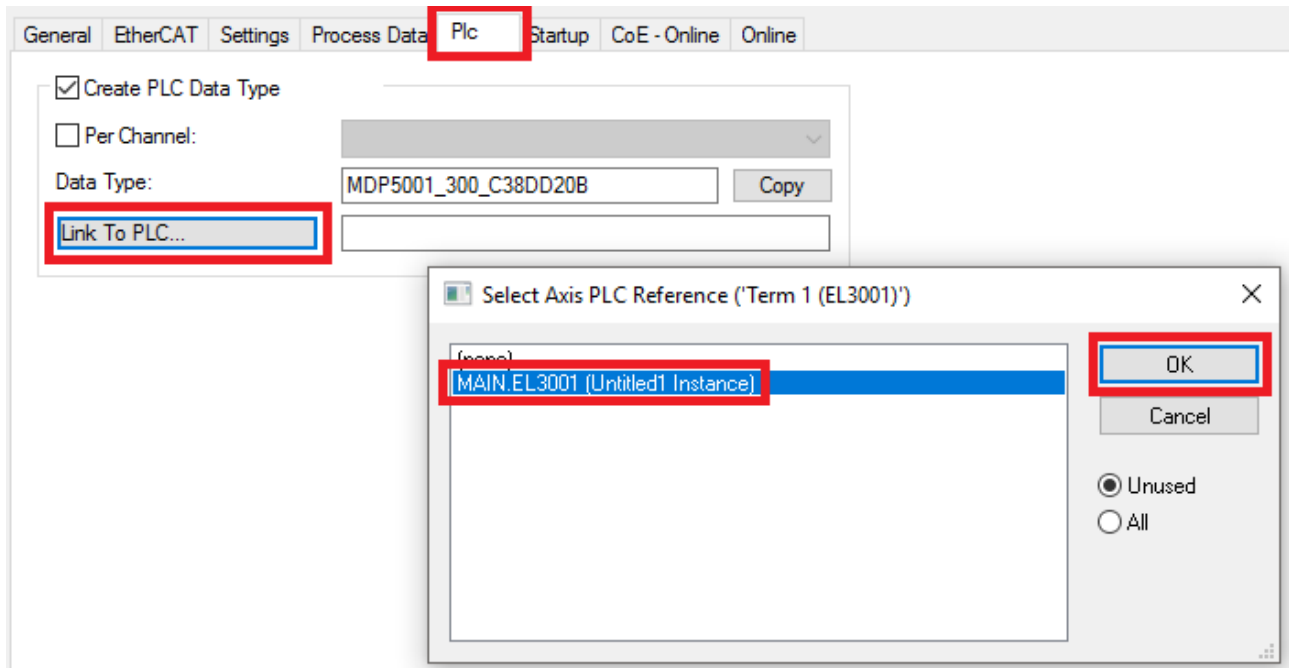

Fig. 119: Linking the structure

7. In the PLC, the process data can then be read or written via the structure in the program code.

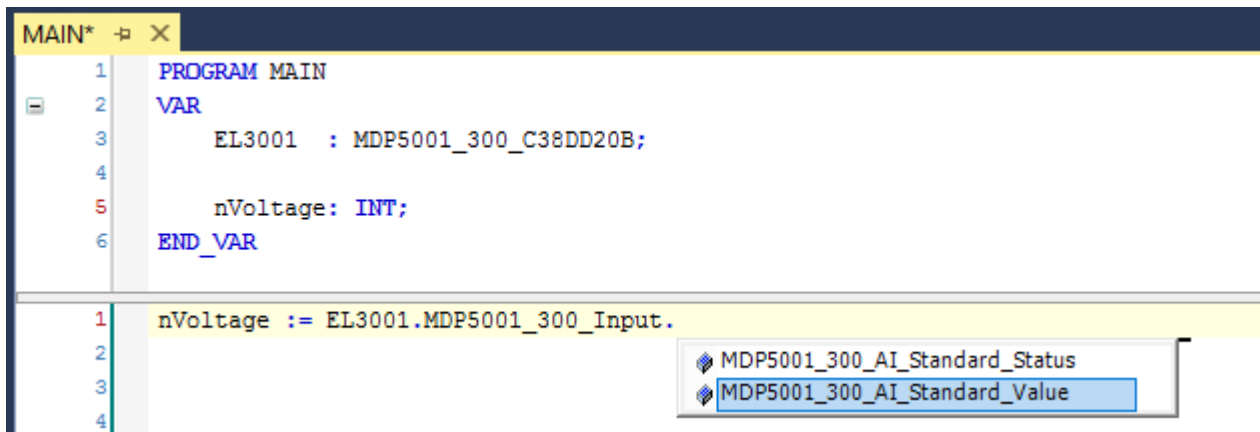



Fig. 120: Reading a variable from the structure of the process data

Activation of the configuration

The allocation of PDO to PLC variables has now established the connection from the controller to the inputs

and outputs of the terminals. The configuration can now be activated with  or via the menu under “TwinCAT” in order to transfer the settings of the development environment to the runtime system. Confirm the messages “Old configurations will be overwritten!” and “Restart TwinCAT system in Run mode” with “OK”. The corresponding assignments can be seen in the project folder explorer:

- Mappings
 - PLC_example Instance - Device 3 (EtherCAT) 1
 - PLC_example Instance - Device 1 (EtherCAT) 1

A few seconds later, the corresponding status of the Run mode is displayed in the form of a rotating symbol

 at the bottom right of the VS shell development environment. The PLC system can then be started as described below.

Starting the controller

Select the menu option “PLC” → “Login” or click on  to link the PLC with the real-time system and load the control program for execution. This results in the message “No program on the controller! Should the new program be loaded?”, which should be acknowledged with “Yes”. The runtime environment is ready for

the program to be started by clicking on symbol , the “F5” key or via “PLC” in the menu, by selecting “Start”. The started programming environment shows the runtime values of individual variables:

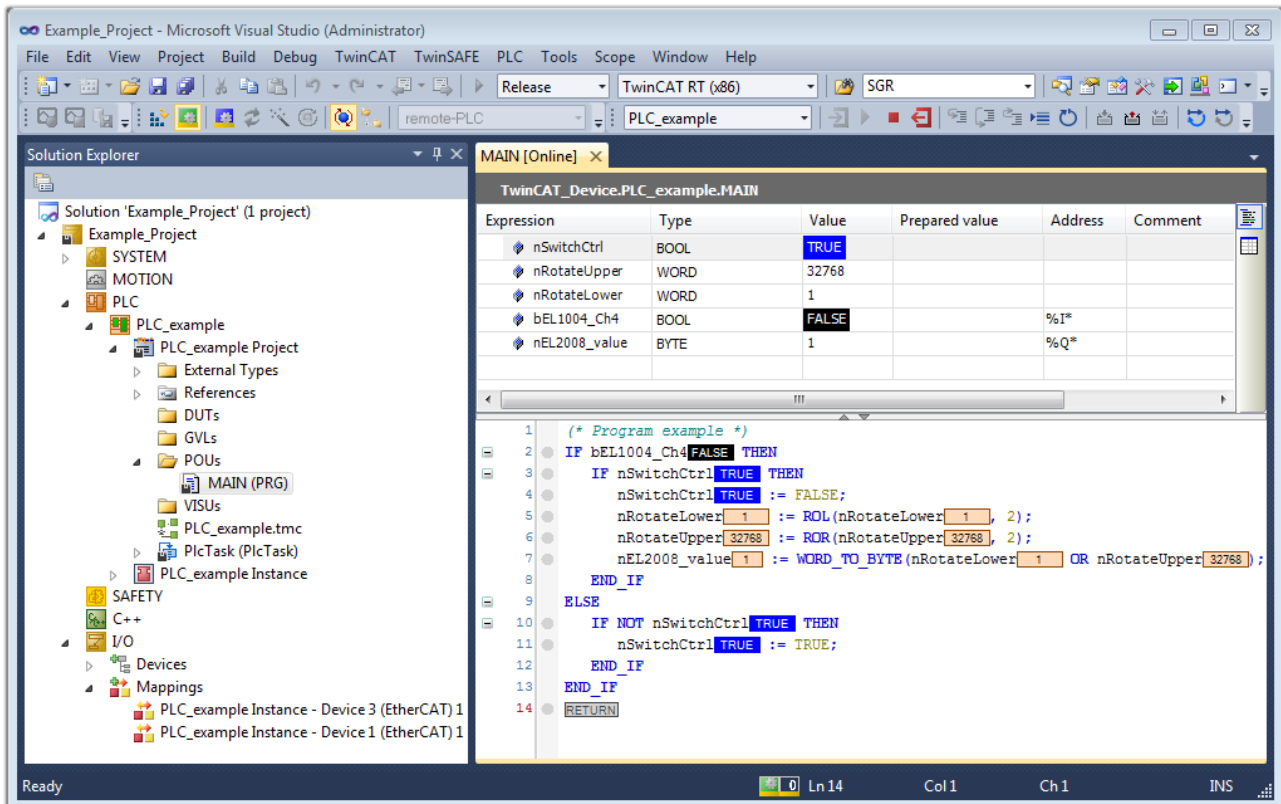



Fig. 121: TwinCAT 3 development environment (VS shell): logged-in, after program startup

The two operator control elements for stopping  and logout  result in the required action (also, “Shift + F5” can be used for stop, or both actions can be selected via the PLC menu).

5.2 TwinCAT Development Environment

The Software for automation TwinCAT (The Windows Control and Automation Technology) will be distinguished into:

- TwinCAT 2: System Manager (Configuration) & PLC Control (Programming)
- TwinCAT 3: Enhancement of TwinCAT 2 (Programming and Configuration takes place via a common Development Environment)

Details:

- **TwinCAT 2:**
 - Connects I/O devices to tasks in a variable-oriented manner
 - Connects tasks to tasks in a variable-oriented manner
 - Supports units at the bit level
 - Supports synchronous or asynchronous relationships
 - Exchange of consistent data areas and process images
 - Datalink on NT - Programs by open Microsoft Standards (OLE, OCX, ActiveX, DCOM+, etc.)
 - Integration of IEC 61131-3-Software-SPS, Software- NC and Software-CNC within Windows NT/ 2000/XP/Vista, Windows 7, NT/XP Embedded, CE
 - Interconnection to all common fieldbusses
 - More...

Additional features:

- **TwinCAT 3 (eXtended Automation):**
 - Visual Studio® integration
 - Choice of the programming language
 - Supports object orientated extension of IEC 61131-3
 - Usage of C/C++ as programming language for real time applications
 - Connection to MATLAB®/Simulink®
 - Open interface for expandability
 - Flexible run-time environment
 - Active support of multi-core- and 64 bit operating system
 - Automatic code generation and project creation with the TwinCAT Automation Interface
 - More...

Within the following sections commissioning of the TwinCAT Development Environment on a PC System for the control and also the basically functions of unique control elements will be explained.

Please see further information to TwinCAT 2 and TwinCAT 3 at <http://infosys.beckhoff.com>.

5.2.1 Installation of the TwinCAT real-time driver

In order to assign real-time capability to a standard Ethernet port of an IPC controller, the Beckhoff real-time driver has to be installed on this port under Windows.

This can be done in several ways.

A: Via the TwinCAT Adapter dialog

In the System Manager call up the TwinCAT overview of the local network interfaces via Options → Show Real Time Ethernet Compatible Devices.

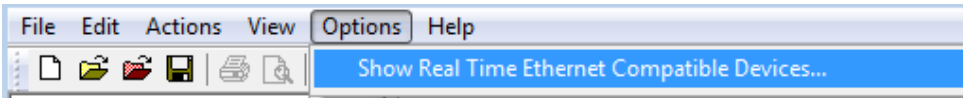

Fig. 122: System Manager “Options” (TwinCAT 2)

This has to be called up by the menu “TwinCAT” within the TwinCAT 3 environment:

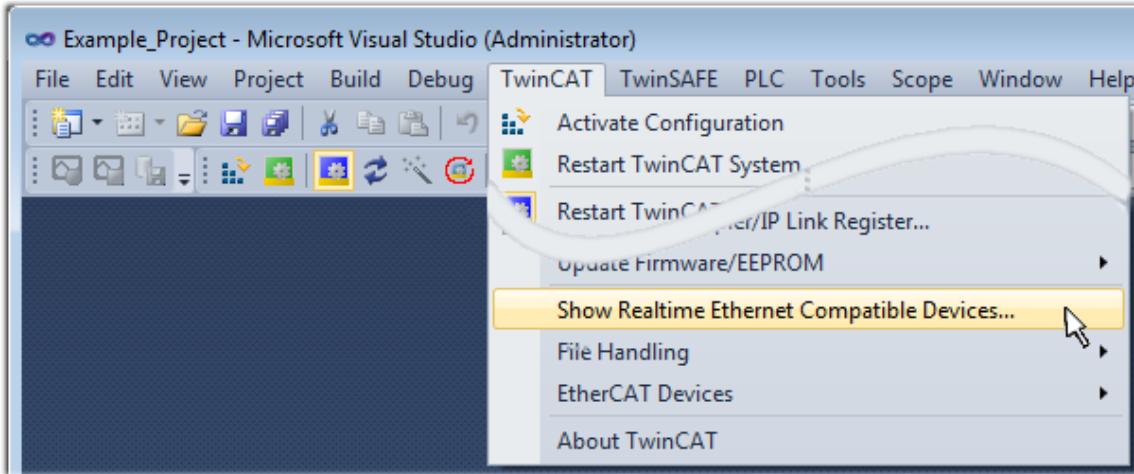

Fig. 123: Call up under VS Shell (TwinCAT 3)

B: Via TcRtelInstall.exe in the TwinCAT directory

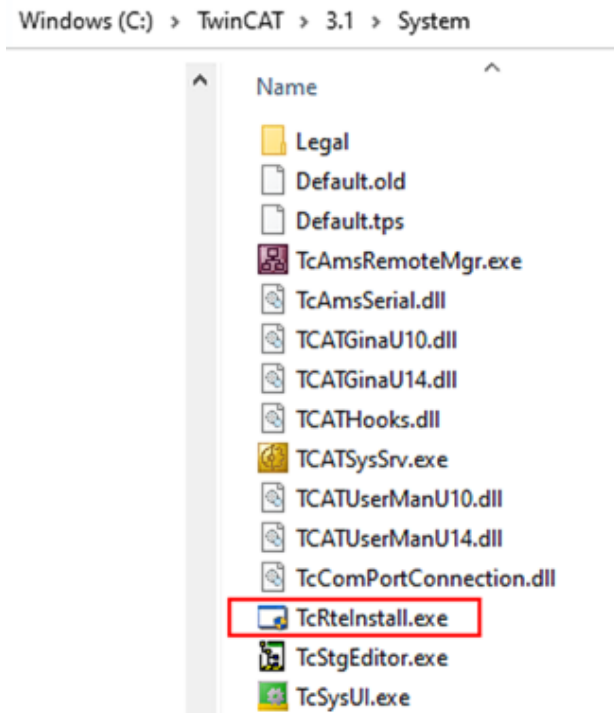

Fig. 124: TcRtelInstall in the TwinCAT directory

In both cases, the following dialog appears:

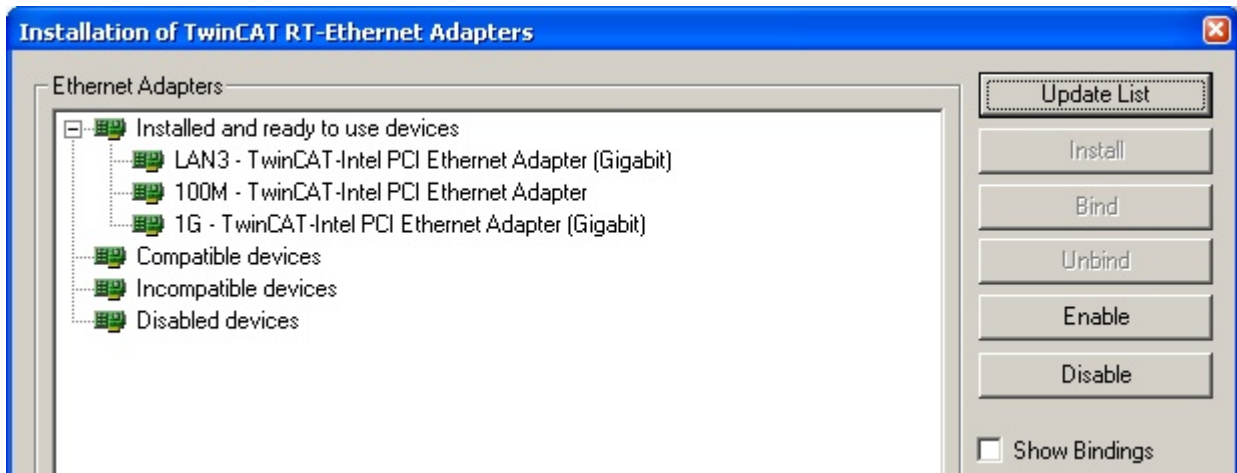

Fig. 125: Overview of network interfaces

Interfaces listed under “Compatible devices” can be assigned a driver via the “Install” button. A driver should only be installed on compatible devices.

A Windows warning regarding the unsigned driver can be ignored.

Alternatively an EtherCAT-device can be inserted first of all as described in chapter [Offline configuration creation](#), section “Creating the EtherCAT device” [▶ 206] in order to view the compatible ethernet ports via its EtherCAT properties (tab “Adapter”, button “Compatible Devices...”):



Fig. 126: EtherCAT device properties (TwinCAT 2): click on “Compatible Devices...” of tab “Adapter”

TwinCAT 3: the properties of the EtherCAT device can be opened by double click on “Device .. (EtherCAT)” within the Solution Explorer under “I/O”:

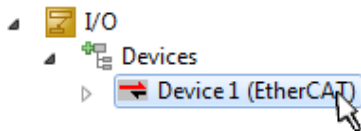

After the installation the driver appears activated in the Windows overview for the network interface (Windows Start → System Properties → Network)

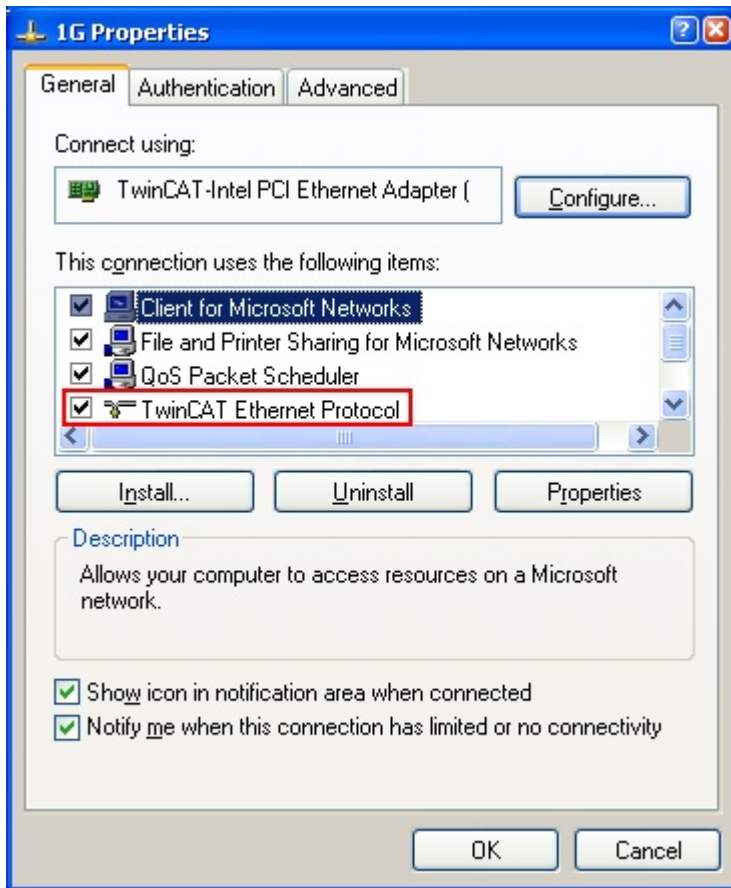

Fig. 127: Windows properties of the network interface

A correct setting of the driver could be:

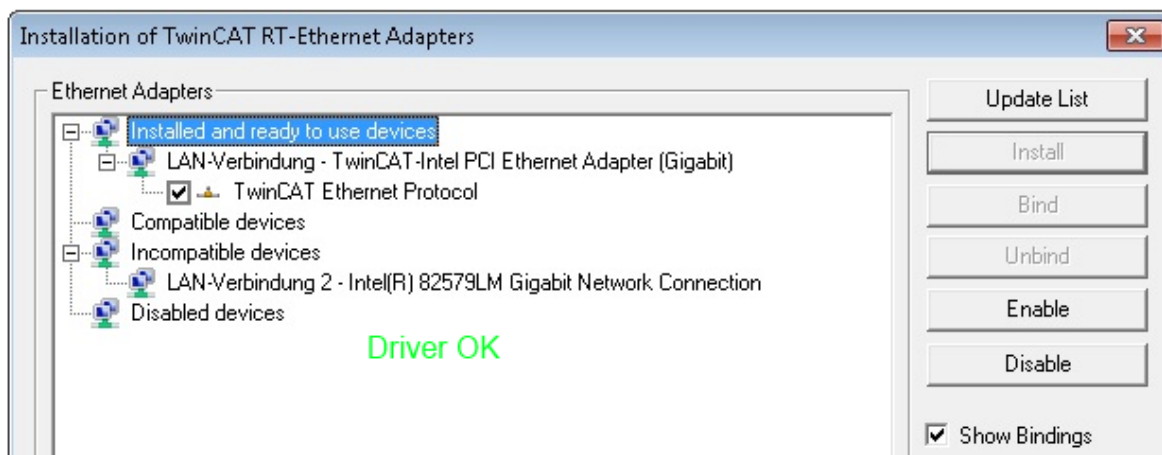

Fig. 128: Exemplary correct driver setting for the Ethernet port

Other possible settings have to be avoided:

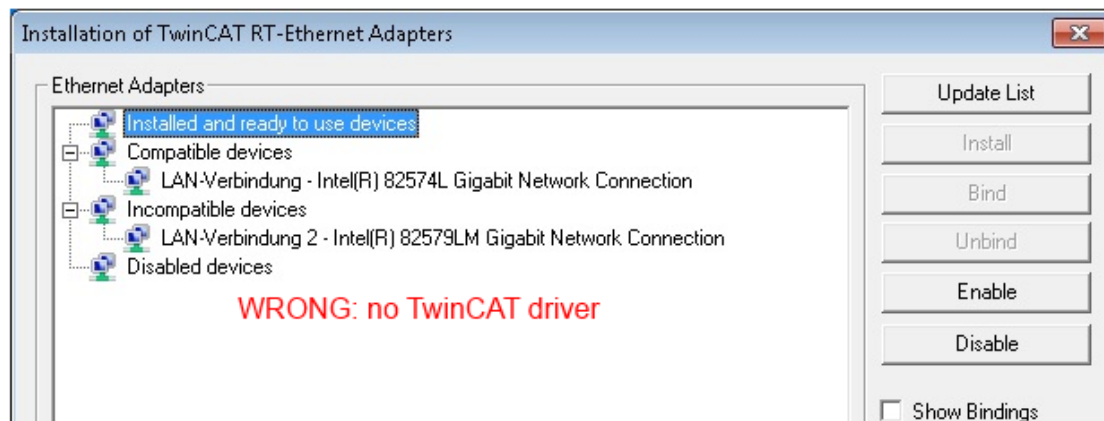
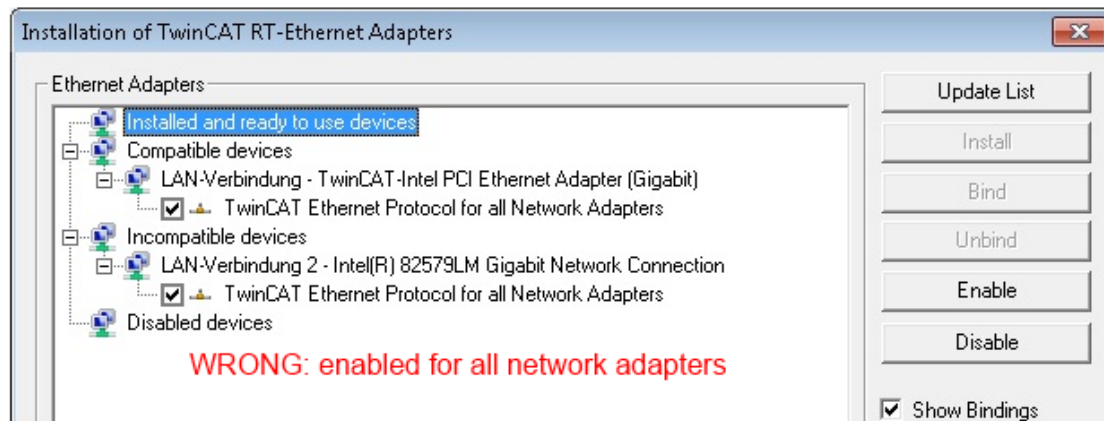
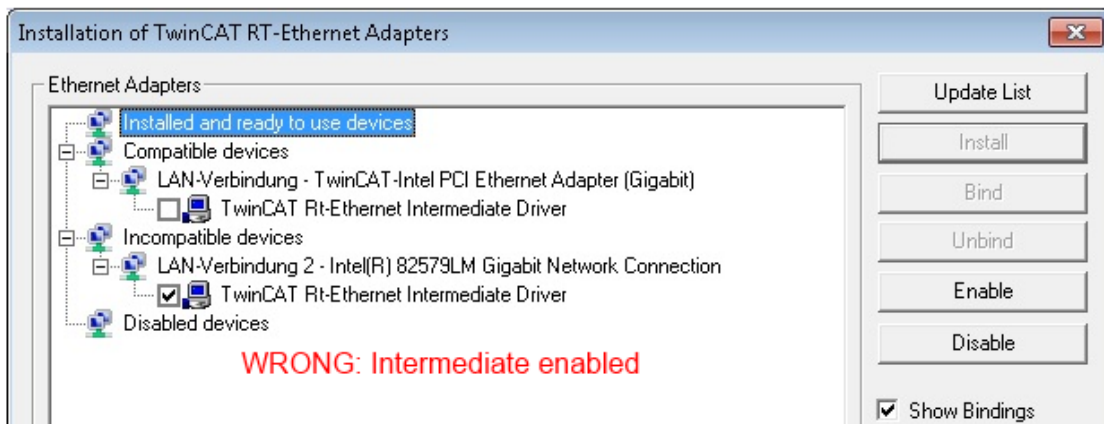
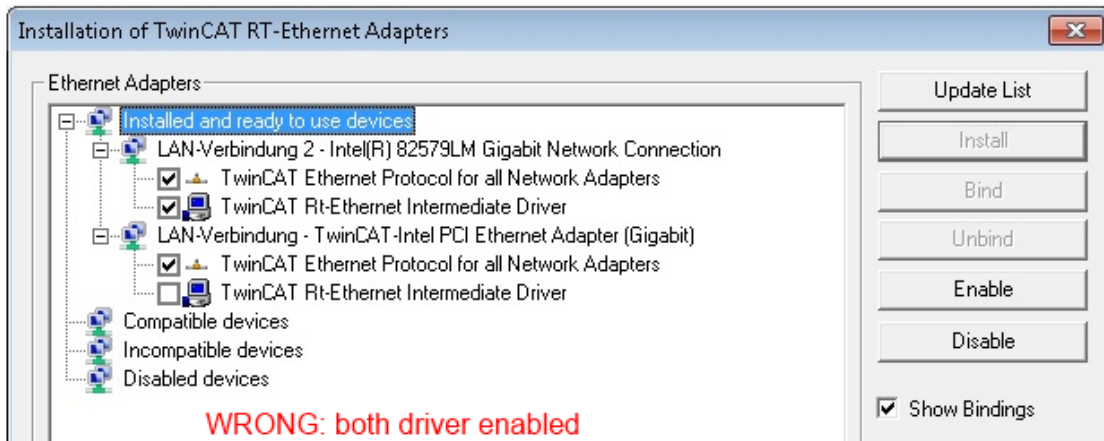

Fig. 129: Incorrect driver settings for the Ethernet port

IP address of the port used

● IP address/DHCP

i In most cases an Ethernet port that is configured as an EtherCAT device will not transport general IP packets. For this reason and in cases where an EL6601 or similar devices are used it is useful to specify a fixed IP address for this port via the “Internet Protocol TCP/IP” driver setting and to disable DHCP. In this way the delay associated with the DHCP client for the Ethernet port assigning itself a default IP address in the absence of a DHCP server is avoided. A suitable address space is 192.168.x.x, for example.

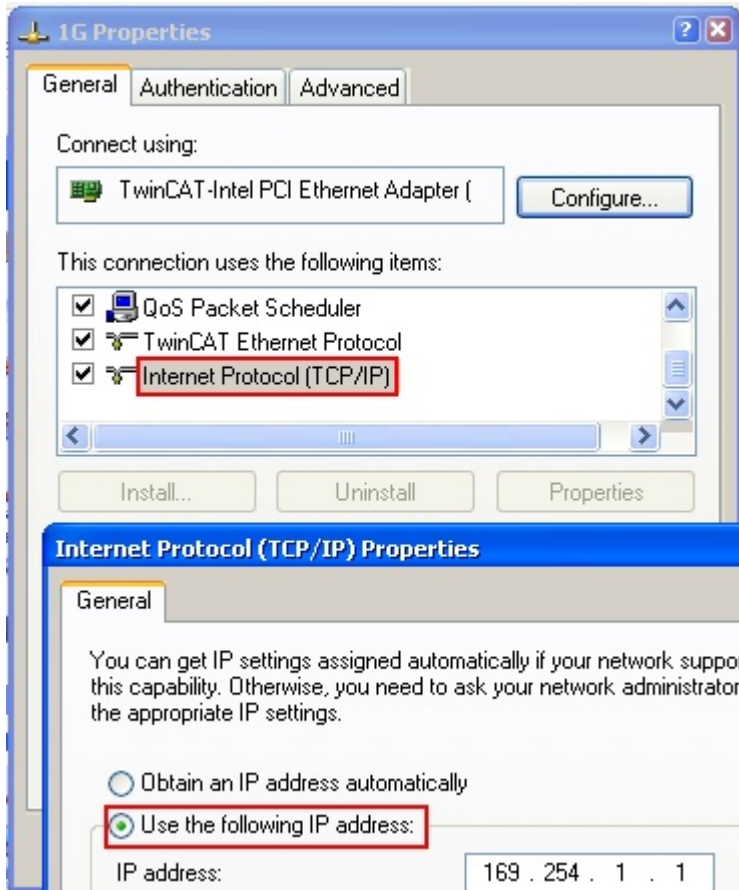

Fig. 130: TCP/IP setting for the Ethernet port

5.2.2 Notes regarding ESI device description

Installation of the latest ESI device description

The TwinCAT EtherCAT master/System Manager needs the device description files for the devices to be used in order to generate the configuration in online or offline mode. The device descriptions are contained in the so-called ESI files (EtherCAT Slave Information) in XML format. These files can be requested from the respective manufacturer and are made available for download. An *.xml file may contain several device descriptions.

The ESI files for Beckhoff EtherCAT devices are available on the [Beckhoff website](#).

The ESI files should be stored in the TwinCAT installation directory.

Default settings:

- **TwinCAT 2:** C:\TwinCAT\IO\EtherCAT
- **TwinCAT 3:** C:\TwinCAT\3.1\Config\Io\EtherCAT

The files are read (once) when a new System Manager window is opened, if they have changed since the last time the System Manager window was opened.

A TwinCAT installation includes the set of Beckhoff ESI files that was current at the time when the TwinCAT build was created.

For TwinCAT 2.11/TwinCAT 3 and higher, the ESI directory can be updated from the System Manager, if the programming PC is connected to the Internet; by

- **TwinCAT 2:** Option → “Update EtherCAT Device Descriptions”
- **TwinCAT 3:** TwinCAT → EtherCAT Devices → “Update Device Descriptions (via ETG Website)...”

The [TwinCAT ESI Updater \[▶ 205\]](#) is available for this purpose.



ESI

The *.xml files are associated with *.xsd files, which describe the structure of the ESI XML files. To update the ESI device descriptions, both file types should therefore be updated.

Device differentiation

EtherCAT devices/slaves are distinguished by four properties, which determine the full device identifier. For example, the device identifier EL2521-0025-1018 consists of:

- family key “EL”
- name “2521”
- type “0025”
- and revision “1018”

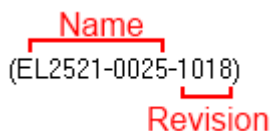

Fig. 131: Identifier structure

The order identifier consisting of name + type (here: EL2521-0025) describes the device function. The revision indicates the technical progress and is managed by Beckhoff. In principle, a device with a higher revision can replace a device with a lower revision, unless specified otherwise, e.g. in the documentation. Each revision has its own ESI description. See [further notes \[▶ 12\]](#).

Online description

If the EtherCAT configuration is created online through scanning of real devices (see section Online setup) and no ESI descriptions are available for a slave (specified by name and revision) that was found, the System Manager asks whether the description stored in the device should be used. In any case, the System Manager needs this information for setting up the cyclic and acyclic communication with the slave correctly.

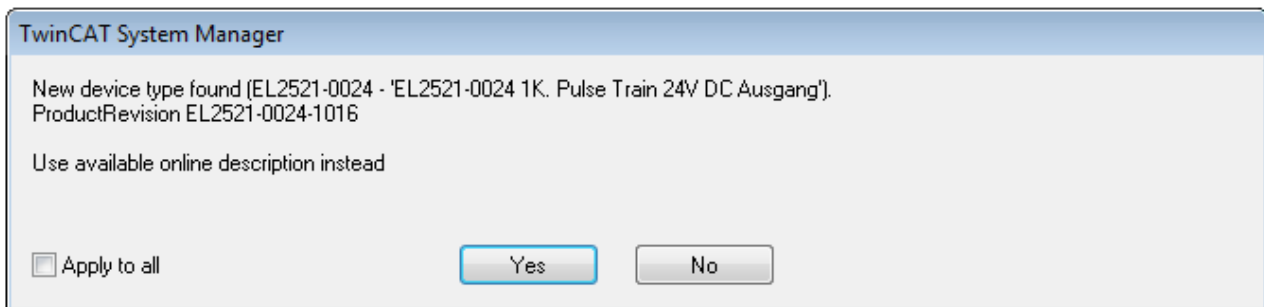

Fig. 132: OnlineDescription information window (TwinCAT 2)

In TwinCAT 3 a similar window appears, which also offers the Web update:

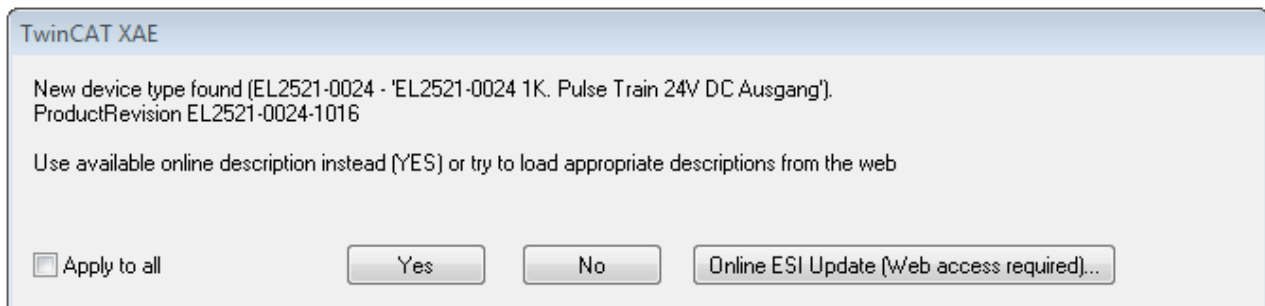

Fig. 133: Information window OnlineDescription (TwinCAT 3)

If possible, the Yes is to be rejected and the required ESI is to be requested from the device manufacturer. After installation of the XML/XSD file the configuration process should be repeated.

NOTICE

Changing the “usual” configuration through a scan

- ✓ If a scan discovers a device that is not yet known to TwinCAT, distinction has to be made between two cases. Taking the example here of the EL2521-0000 in the revision 1019
 - a) no ESI is present for the EL2521-0000 device at all, either for the revision 1019 or for an older revision. The ESI must then be requested from the manufacturer (in this case Beckhoff).
 - b) an ESI is present for the EL2521-0000 device, but only in an older revision, e.g. 1018 or 1017. In this case an in-house check should first be performed to determine whether the spare parts stock allows the integration of the increased revision into the configuration at all. A new/higher revision usually also brings along new features. If these are not to be used, work can continue without reservations with the previous revision 1018 in the configuration. This is also stated by the Beckhoff compatibility rule.

Refer in particular to the chapter “[General notes on the use of Beckhoff EtherCAT IO components](#)” and for manual configuration to the chapter “[Offline configuration creation \[► 206\]](#)”.

If the OnlineDescription is used regardless, the System Manager reads a copy of the device description from the EEPROM in the EtherCAT slave. In complex slaves the size of the EEPROM may not be sufficient for the complete ESI, in which case the ESI would be *incomplete* in the configurator. Therefore it's recommended using an offline ESI file with priority in such a case.

The System Manager creates for online recorded device descriptions a new file “OnlineDescription0000...xml” in its ESI directory, which contains all ESI descriptions that were read online.

OnlineDescriptionCache00000002.xml

Fig. 134: File OnlineDescription.xml created by the System Manager

If a slave desired to be added manually to the configuration at a later stage, online created slaves are indicated by a prepended symbol ">" in the selection list (see Figure *Indication of an online recorded ESI of EL2521 as an example*).

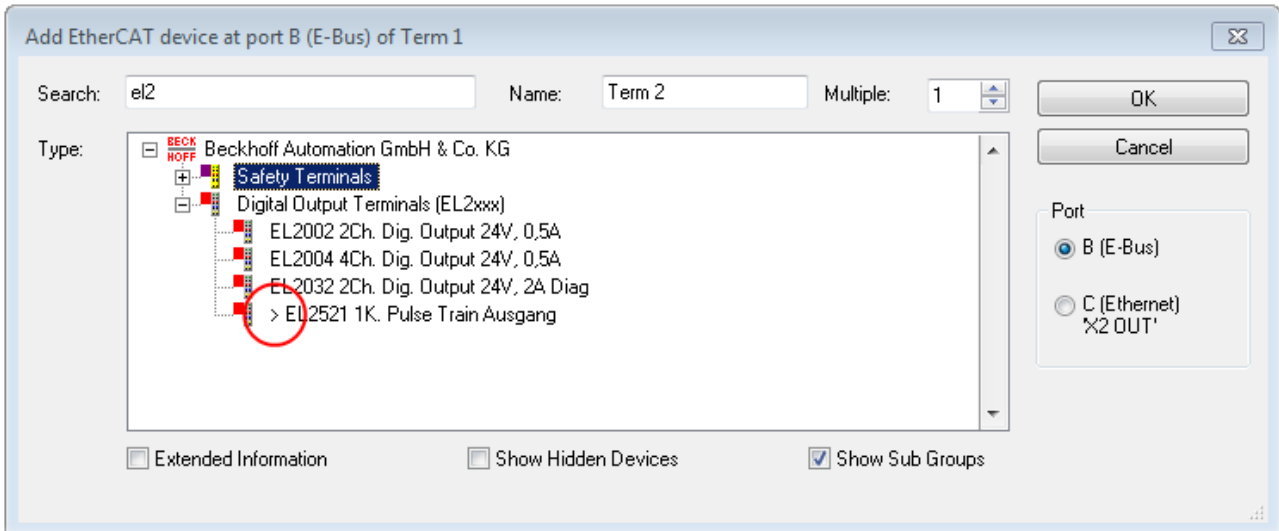

Fig. 135: Indication of an online recorded ESI of EL2521 as an example

If such ESI files are used and the manufacturer's files become available later, the file OnlineDescription.xml should be deleted as follows:

- close all System Manager windows
- restart TwinCAT in Config mode
- delete "OnlineDescription0000...xml"
- restart TwinCAT System Manager

This file should not be visible after this procedure, if necessary press <F5> to update

i OnlineDescription for TwinCAT 3.x

In addition to the file described above "OnlineDescription0000...xml", a so called EtherCAT cache with new discovered devices is created by TwinCAT 3.x, e.g. under Windows 7:

```
C:\User\[USERNAME]\AppData\Roaming\Beckhoff\TwinCAT3\Components\Base\EtherCATCache.xml
```

(Please note the language settings of the OS!)
You have to delete this file, too.

Faulty ESI file

If an ESI file is faulty and the System Manager is unable to read it, the System Manager brings up an information window.

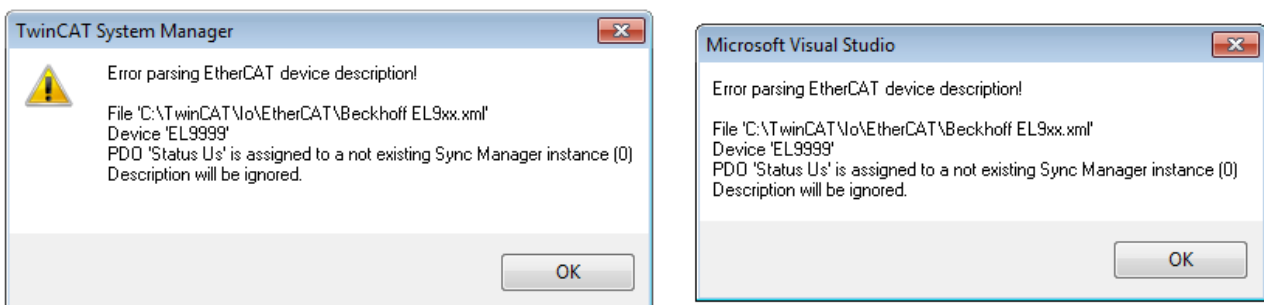

Fig. 136: Information window for faulty ESI file (left: TwinCAT 2; right: TwinCAT 3)

Reasons may include:

- Structure of the *.xml does not correspond to the associated *.xsd file → check your schematics
- Contents cannot be translated into a device description → contact the file manufacturer

5.2.3 TwinCAT ESI Updater

For TwinCAT 2.11 and higher, the System Manager can search for current Beckhoff ESI files automatically, if an online connection is available:

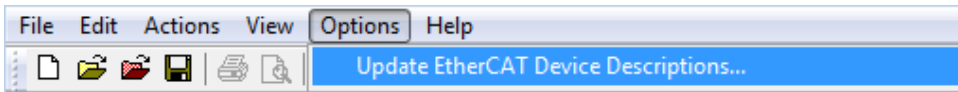

Fig. 137: Using the ESI Updater (>= TwinCAT 2.11)

The call up takes place under:
 “Options” → “Update EtherCAT Device Descriptions”

Selection under TwinCAT 3:

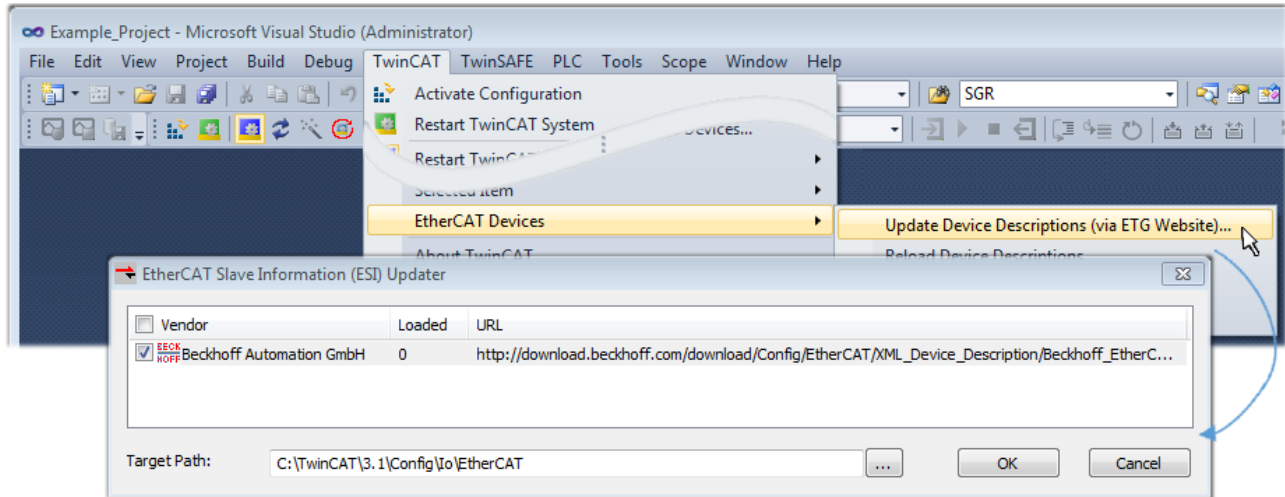

Fig. 138: Using the ESI Updater (TwinCAT 3)

The ESI Updater (TwinCAT 3) is a convenient option for automatic downloading of ESI data provided by EtherCAT manufacturers via the Internet into the TwinCAT directory (ESI = EtherCAT slave information). TwinCAT accesses the central ESI ULR directory list stored at ETG; the entries can then be viewed in the Updater dialog, although they cannot be changed there.

The call up takes place under:
 “TwinCAT” → “EtherCAT Devices” → “Update Device Description (via ETG Website)...”.

5.2.4 Distinction between Online and Offline

The distinction between online and offline refers to the presence of the actual I/O environment (drives, terminals, EJ-modules). If the configuration is to be prepared in advance of the system configuration as a programming system, e.g. on a laptop, this is only possible in “Offline configuration” mode. In this case all components have to be entered manually in the configuration, e.g. based on the electrical design.

If the designed control system is already connected to the EtherCAT system and all components are energised and the infrastructure is ready for operation, the TwinCAT configuration can simply be generated through “scanning” from the runtime system. This is referred to as online configuration.

In any case, during each startup the EtherCAT master checks whether the slaves it finds match the configuration. This test can be parameterised in the extended slave settings. Refer to [note “Installation of the latest ESI-XML device description” \[► 201\]](#).

For preparation of a configuration:

- the real EtherCAT hardware (devices, couplers, drives) must be present and installed
- the devices/modules must be connected via EtherCAT cables or in the terminal/ module strand in the same way as they are intended to be used later
- the devices/modules be connected to the power supply and ready for communication

- TwinCAT must be in CONFIG mode on the target system.

The online scan process consists of:

- detecting the EtherCAT device [▶ 211] (Ethernet port at the IPC)
- detecting the connected EtherCAT devices [▶ 212]. This step can be carried out independent of the preceding step
- troubleshooting [▶ 215]

The scan with existing configuration [▶ 216] can also be carried out for comparison.

5.2.5 OFFLINE configuration creation

Creating the EtherCAT device

Create an EtherCAT device in an empty System Manager window.

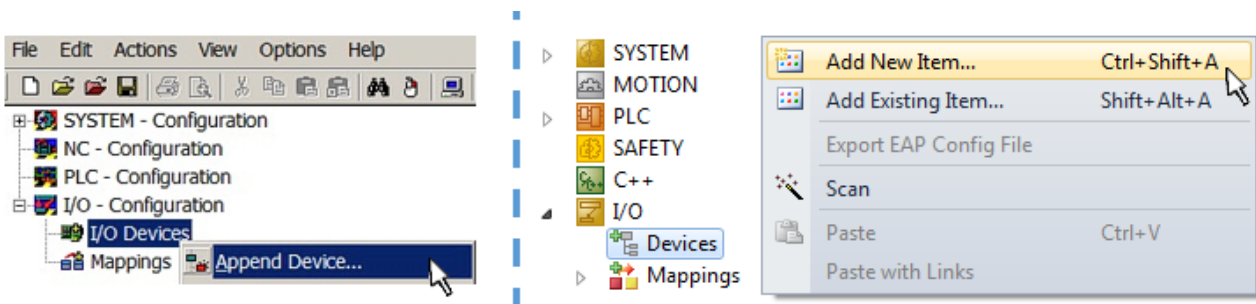

Fig. 139: Append EtherCAT device (left: TwinCAT 2; right: TwinCAT 3)

Select type “EtherCAT” for an EtherCAT I/O application with EtherCAT slaves. For the present publisher/ subscriber service in combination with an EL6601/EL6614 terminal select “EtherCAT Automation Protocol via EL6601”.

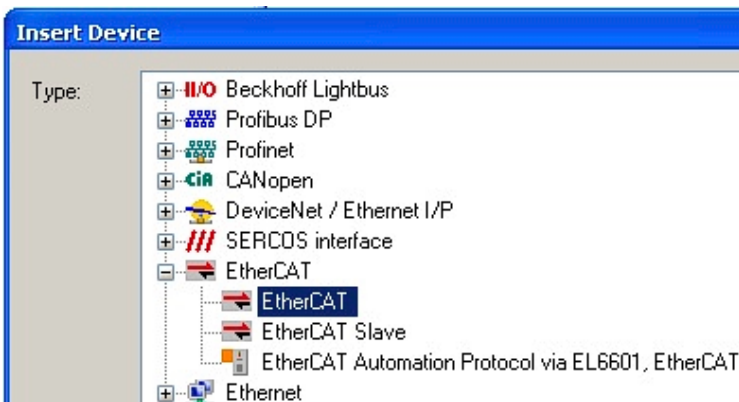

Fig. 140: Selecting the EtherCAT connection (TwinCAT 2.11, TwinCAT 3)

Then assign a real Ethernet port to this virtual device in the runtime system.

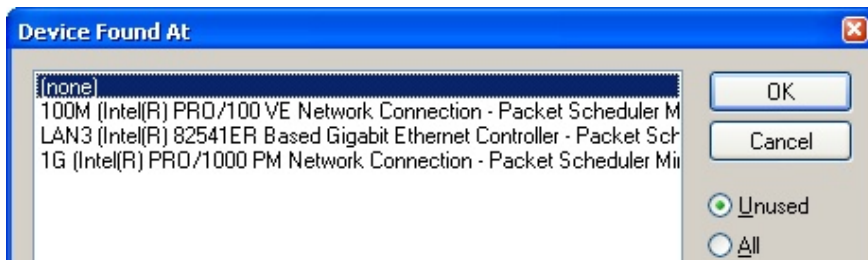

Fig. 141: Selecting the Ethernet port

This query may appear automatically when the EtherCAT device is created, or the assignment can be set/modified later in the properties dialog; see Fig. “EtherCAT device properties (TwinCAT 2)”.

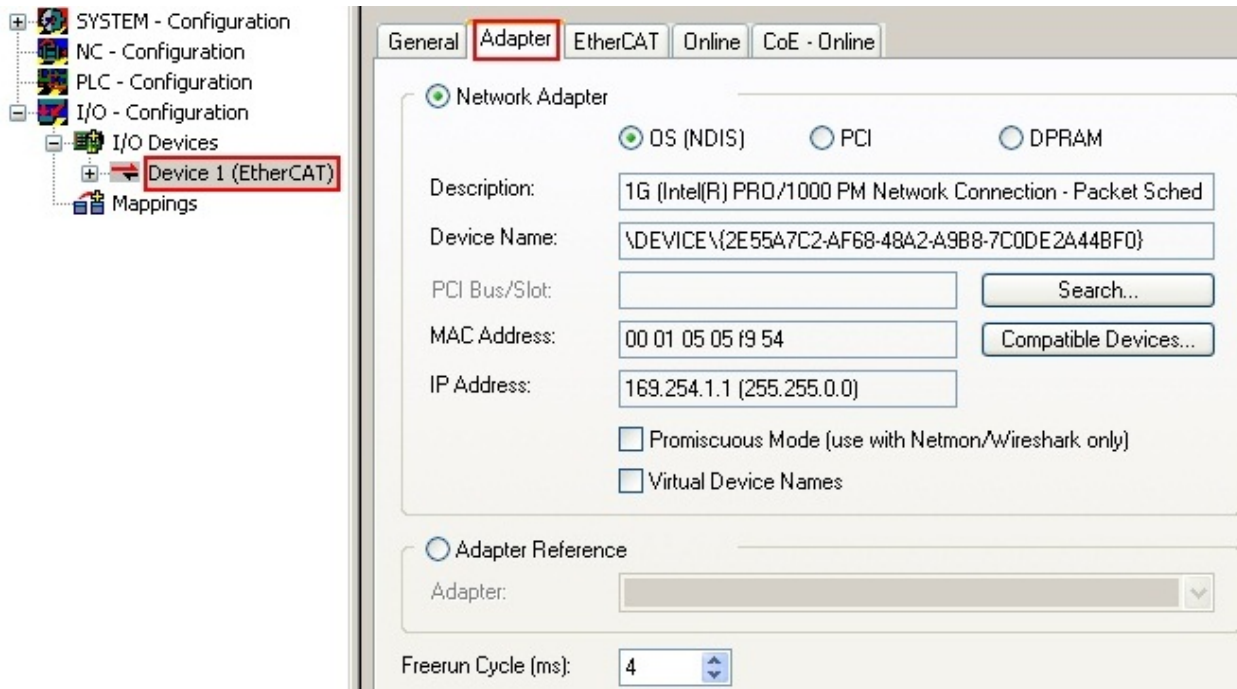
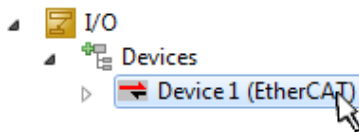

Fig. 142: EtherCAT device properties (TwinCAT 2)

TwinCAT 3: the properties of the EtherCAT device can be opened by double click on “Device .. (EtherCAT)” within the Solution Explorer under “I/O”:



i **Selecting the Ethernet port**

Ethernet ports can only be selected for EtherCAT devices for which the TwinCAT real-time driver is installed. This has to be done separately for each port. Please refer to the respective [installation page \[p. 195\]](#).

Defining EtherCAT slaves

Further devices can be appended by right-clicking on a device in the configuration tree.

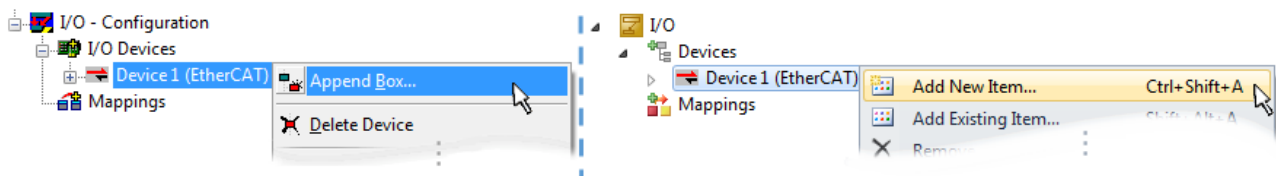

Fig. 143: Appending EtherCAT devices (left: TwinCAT 2; right: TwinCAT 3)

The dialog for selecting a new device opens. Only devices for which ESI files are available are displayed.

Only devices are offered for selection that can be appended to the previously selected device. Therefore, the physical layer available for this port is also displayed (Fig. “Selection dialog for new EtherCAT device”, A). In the case of cable-based Fast-Ethernet physical layer with PHY transfer, then also only cable-based devices are available, as shown in Fig. “Selection dialog for new EtherCAT device”. If the preceding device has several free ports (e.g. EK1122 or EK1100), the required port can be selected on the right-hand side (A).

Overview of physical layer

- “Ethernet”: cable-based 100BASE-TX: couplers, box modules, devices with RJ45/M8/M12 connector

- “E-Bus”: LVDS “terminal bus”, EtherCAT plug-in modules (EJ), EtherCAT terminals (EL/ES), various modular modules

The search field facilitates finding specific devices (since TwinCAT 2.11 or TwinCAT 3).

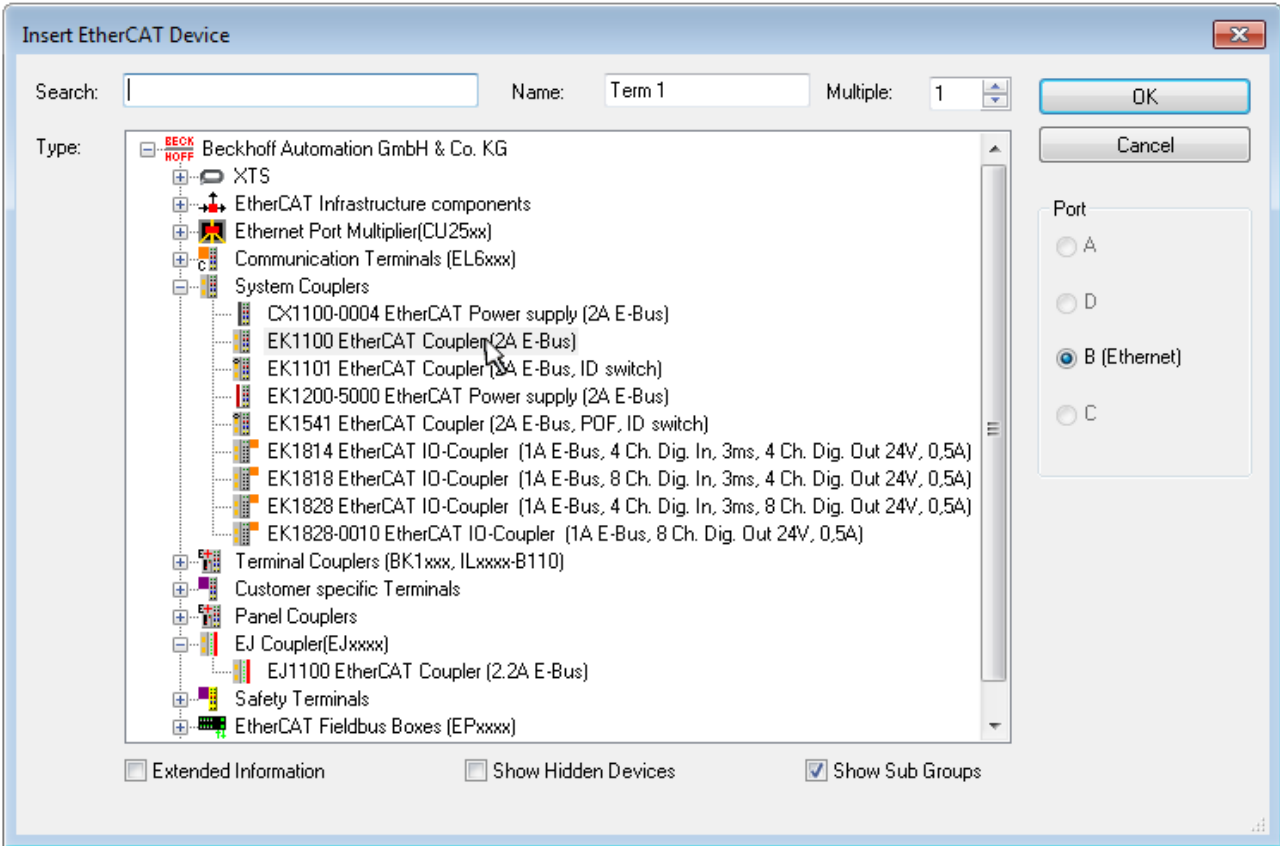

Fig. 144: Selection dialog for new EtherCAT device

By default, only the name/device type is used as selection criterion. For selecting a specific revision of the device, the revision can be displayed as “Extended Information”.

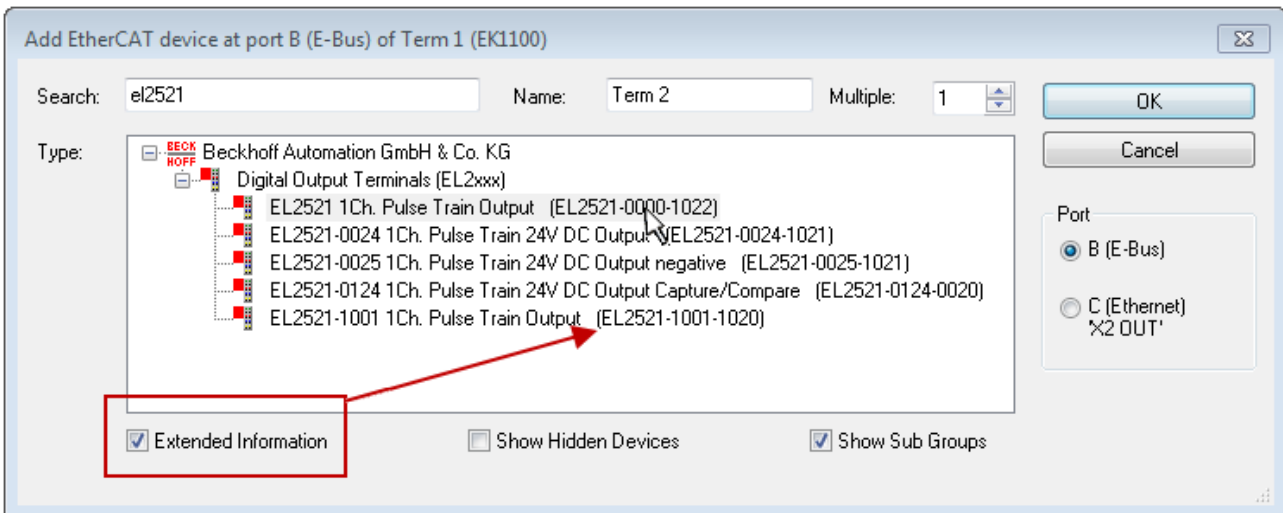

Fig. 145: Display of device revision

In many cases several device revisions were created for historic or functional reasons, e.g. through technological advancement. For simplification purposes (see Fig. “Selection dialog for new EtherCAT device”) only the last (i.e. highest) revision and therefore the latest state of production is displayed in the selection dialog for Beckhoff devices. To show all device revisions available in the system as ESI descriptions tick the “Show Hidden Devices” check box, see Fig. “Display of previous revisions”.

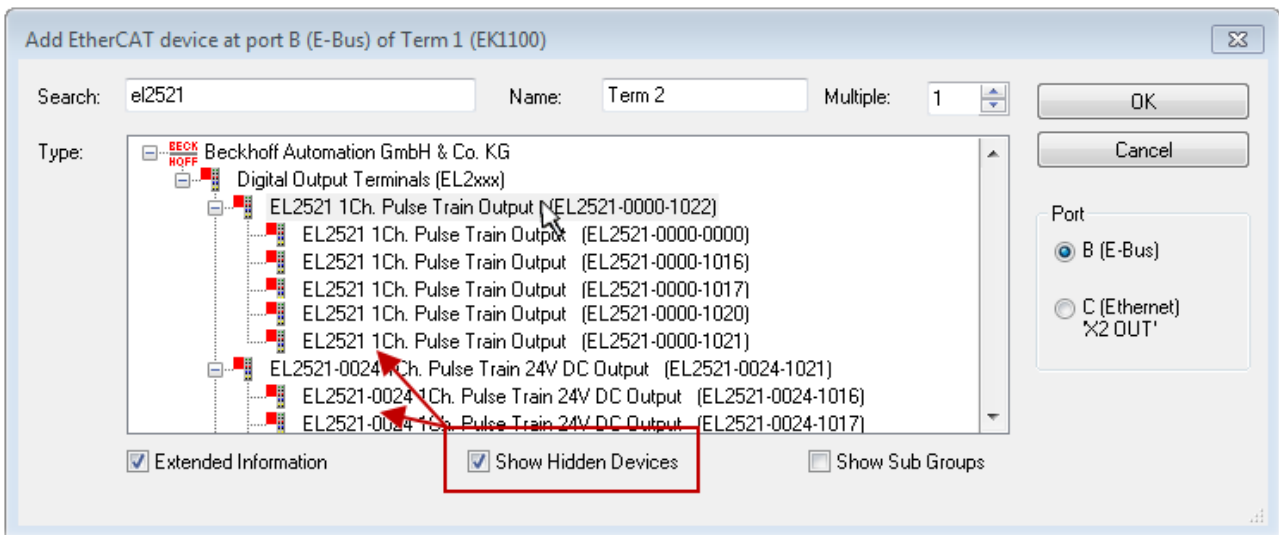

Fig. 146: Display of previous revisions

i **Device selection based on revision, compatibility**

The ESI description also defines the process image, the communication type between master and slave/device and the device functions, if applicable. The physical device (firmware, if available) has to support the communication queries/settings of the master. This is backward compatible, i.e. newer devices (higher revision) should be supported if the EtherCAT master addresses them as an older revision. The following compatibility rule of thumb is to be assumed for Beckhoff EtherCAT Terminals/ Boxes/ EJ-modules:

device revision in the system >= device revision in the configuration

This also enables subsequent replacement of devices without changing the configuration (different specifications are possible for drives).

Example

If an EL2521-0025-1018 is specified in the configuration, an EL2521-0025-1018 or higher (-1019, -1020) can be used in practice.

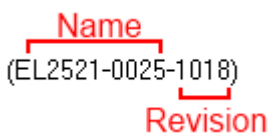

Fig. 147: Name/revision of the terminal

If current ESI descriptions are available in the TwinCAT system, the last revision offered in the selection dialog matches the Beckhoff state of production. It is recommended to use the last device revision when creating a new configuration, if current Beckhoff devices are used in the real application. Older revisions should only be used if older devices from stock are to be used in the application.

In this case the process image of the device is shown in the configuration tree and can be parameterized as follows: linking with the task, CoE/DC settings, plug-in definition, startup settings, ...

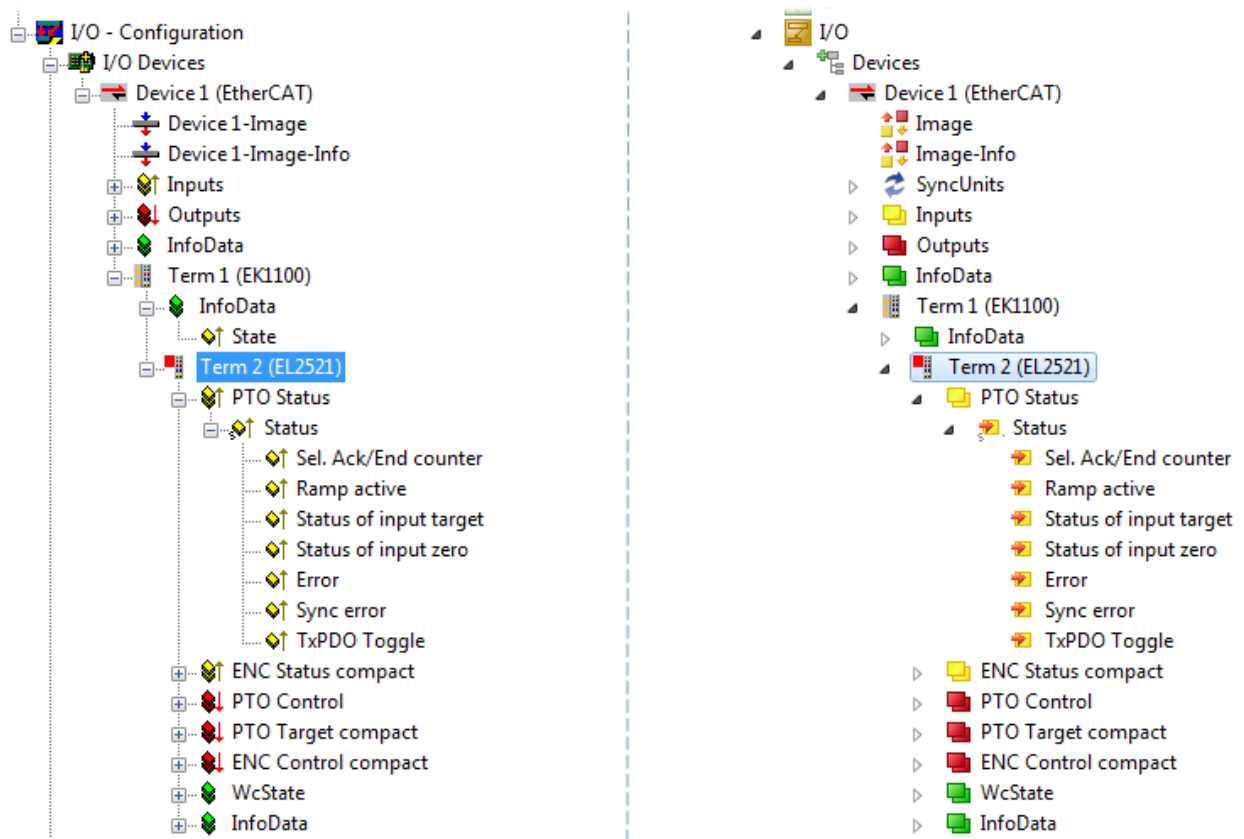



Fig. 148: EtherCAT terminal in the TwinCAT tree (left: TwinCAT 2; right: TwinCAT 3)



5.2.6 ONLINE configuration creation

Detecting/scanning of the EtherCAT device

The online device search can be used if the TwinCAT system is in CONFIG mode. This can be indicated by a symbol right below in the information bar:

- on TwinCAT 2 by a blue display “Config Mode” within the System Manager window:  .
- on TwinCAT 3 within the user interface of the development environment by a symbol  .



TwinCAT can be set into this mode:

- TwinCAT 2: by selection of  in the Menubar or by “Actions” → “Set/Reset TwinCAT to Config Mode...”
- TwinCAT 3: by selection of  in the Menubar or by “TwinCAT” → “Restart TwinCAT (Config Mode)”

● Online scanning in Config mode

I

The online search is not available in RUN mode (production operation). Note the differentiation between TwinCAT programming system and TwinCAT target system.

The TwinCAT 2 icon () or TwinCAT 3 icon () within the Windows-Taskbar always shows the TwinCAT mode of the local IPC. Compared to that, the System Manager window of TwinCAT 2 or the user interface of TwinCAT 3 indicates the state of the target system.

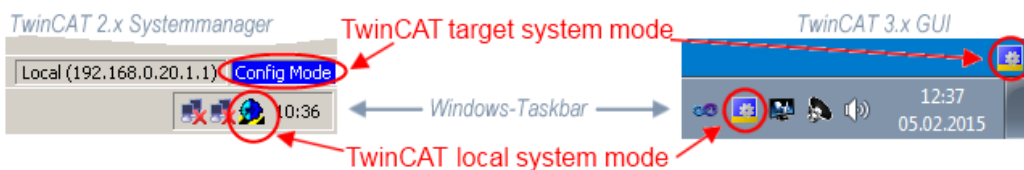

Fig. 149: Differentiation local/target system (left: TwinCAT 2; right: TwinCAT 3)

Right-clicking on “I/O Devices” in the configuration tree opens the search dialog.

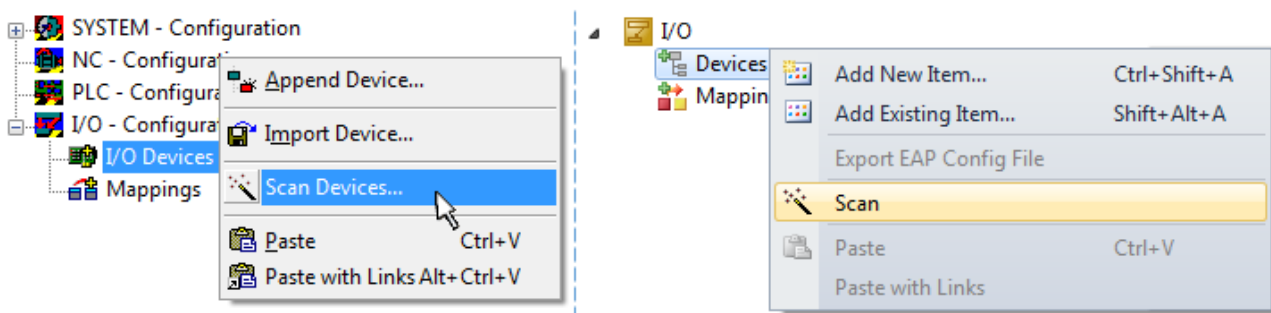

Fig. 150: Scan Devices (left: TwinCAT 2; right: TwinCAT 3)

This scan mode attempts to find not only EtherCAT devices (or Ethernet ports that are usable as such), but also NOVDRAM, fieldbus cards, SMB etc. However, not all devices can be found automatically.

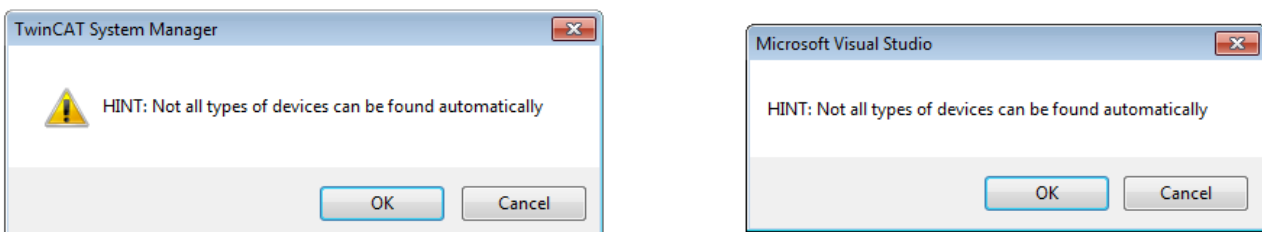

Fig. 151: Note for automatic device scan (left: TwinCAT 2; right: TwinCAT 3)

Ethernet ports with installed TwinCAT real-time driver are shown as “RT Ethernet” devices. An EtherCAT frame is sent to these ports for testing purposes. If the scan agent detects from the response that an EtherCAT slave is connected, the port is immediately shown as an “EtherCAT Device” .

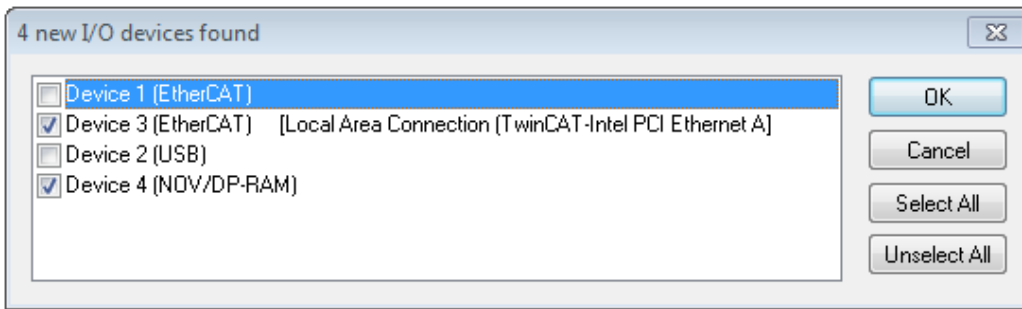

Fig. 152: Detected Ethernet devices

Via respective checkboxes devices can be selected (as illustrated in Fig. “Detected Ethernet devices” e.g. Device 3 and Device 4 were chosen). After confirmation with “OK” a device scan is suggested for all selected devices, see Fig.: “Scan query after automatic creation of an EtherCAT device”.

● Selecting the Ethernet port



Ethernet ports can only be selected for EtherCAT devices for which the TwinCAT real-time driver is installed. This has to be done separately for each port. Please refer to the respective [installation page](#) [▶ 195].

Detecting/Scanning the EtherCAT devices

● Online scan functionality



During a scan the master queries the identity information of the EtherCAT slaves from the slave EEPROM. The name and revision are used for determining the type. The respective devices are located in the stored ESI data and integrated in the configuration tree in the default state defined there.

Name
(EL2521-0025-1018)
Revision

Fig. 153: Example default state

NOTICE

Slave scanning in practice in series machine production

The scanning function should be used with care. It is a practical and fast tool for creating an initial configuration as a basis for commissioning. In series machine production or reproduction of the plant, however, the function should no longer be used for the creation of the configuration, but if necessary for [comparison](#) [▶ 216] with the defined initial configuration. Background: since Beckhoff occasionally increases the revision version of the delivered products for product maintenance reasons, a configuration can be created by such a scan which (with an identical machine construction) is identical according to the device list; however, the respective device revision may differ from the initial configuration.

Example:

Company A builds the prototype of a machine B, which is to be produced in series later on. To do this the prototype is built, a scan of the IO devices is performed in TwinCAT and the initial configuration “B.tsm” is created. The EL2521-0025 EtherCAT terminal with the revision 1018 is located somewhere. It is thus built into the TwinCAT configuration in this way:

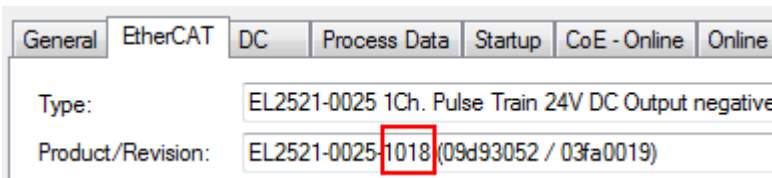

Fig. 154: Installing EthetCAT terminal with revision -1018

Likewise, during the prototype test phase, the functions and properties of this terminal are tested by the programmers/commissioning engineers and used if necessary, i.e. addressed from the PLC “B.pro” or the NC. (the same applies correspondingly to the TwinCAT 3 solution files).

The prototype development is now completed and series production of machine B starts, for which Beckhoff continues to supply the EL2521-0025-0018. If the commissioning engineers of the series machine production department always carry out a scan, a B configuration with the identical contents results again for each machine. Likewise, A might create spare parts stores worldwide for the coming series-produced machines with EL2521-0025-1018 terminals.

After some time Beckhoff extends the EL2521-0025 by a new feature C. Therefore the FW is changed, outwardly recognizable by a higher FW version and a **new revision -1019**. Nevertheless the new device naturally supports functions and interfaces of the predecessor version(s); an adaptation of “B.tsm” or even “B.pro” is therefore unnecessary. The series-produced machines can continue to be built with “B.tsm” and “B.pro”; it makes sense to perform a comparative scan [▶ 216] against the initial configuration “B.tsm” in order to check the built machine.

However, if the series machine production department now doesn't use “B.tsm”, but instead carries out a scan to create the productive configuration, the revision **-1019** is automatically detected and built into the configuration:

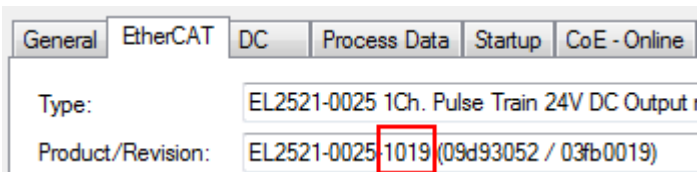

Fig. 155: Detection of EtherCAT terminal with revision -1019

This is usually not noticed by the commissioning engineers. TwinCAT cannot signal anything either, since a new configuration is essentially created. According to the compatibility rule, however, this means that no EL2521-0025-**1018** should be built into this machine as a spare part (even if this nevertheless works in the vast majority of cases).

In addition, it could be the case that, due to the development accompanying production in company A, the new feature C of the EL2521-0025-1019 (for example, an improved analog filter or an additional process data for the diagnosis) is discovered and used without in-house consultation. The previous stock of spare part devices are then no longer to be used for the new configuration “B2.tsm” created in this way. If series machine production is established, the scan should only be performed for informative purposes for comparison with a defined initial configuration. Changes are to be made with care!

If an EtherCAT device was created in the configuration (manually or through a scan), the I/O field can be scanned for devices/slaves.



Fig. 156: Scan query after automatic creation of an EtherCAT device (left: TwinCAT 2; right: TwinCAT 3)

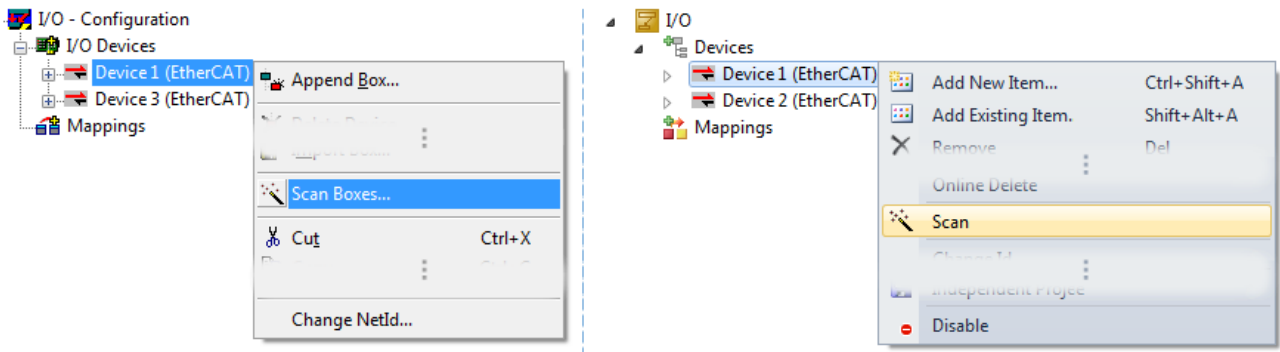

Fig. 157: Manual scanning for devices on a specified EtherCAT device (left: TwinCAT 2; right: TwinCAT 3)

In the System Manager (TwinCAT 2) or the User Interface (TwinCAT 3) the scan process can be monitored via the progress bar at the bottom in the status bar.



Fig. 158: Scan progress exemplary by TwinCAT 2

The configuration is established and can then be switched to online state (OPERATIONAL).



Fig. 159: Config/FreeRun query (left: TwinCAT 2; right: TwinCAT 3)

In Config/FreeRun mode the System Manager display alternates between blue and red, and the EtherCAT device continues to operate with the idling cycle time of 4 ms (default setting), even without active task (NC, PLC).



Fig. 160: Displaying of “Free Run” and “Config Mode” toggling right below in the status bar



Fig. 161: TwinCAT can also be switched to this state by using a button (left: TwinCAT 2; right: TwinCAT 3)

The EtherCAT system should then be in a functional cyclic state, as shown in Fig. *Online display example*.

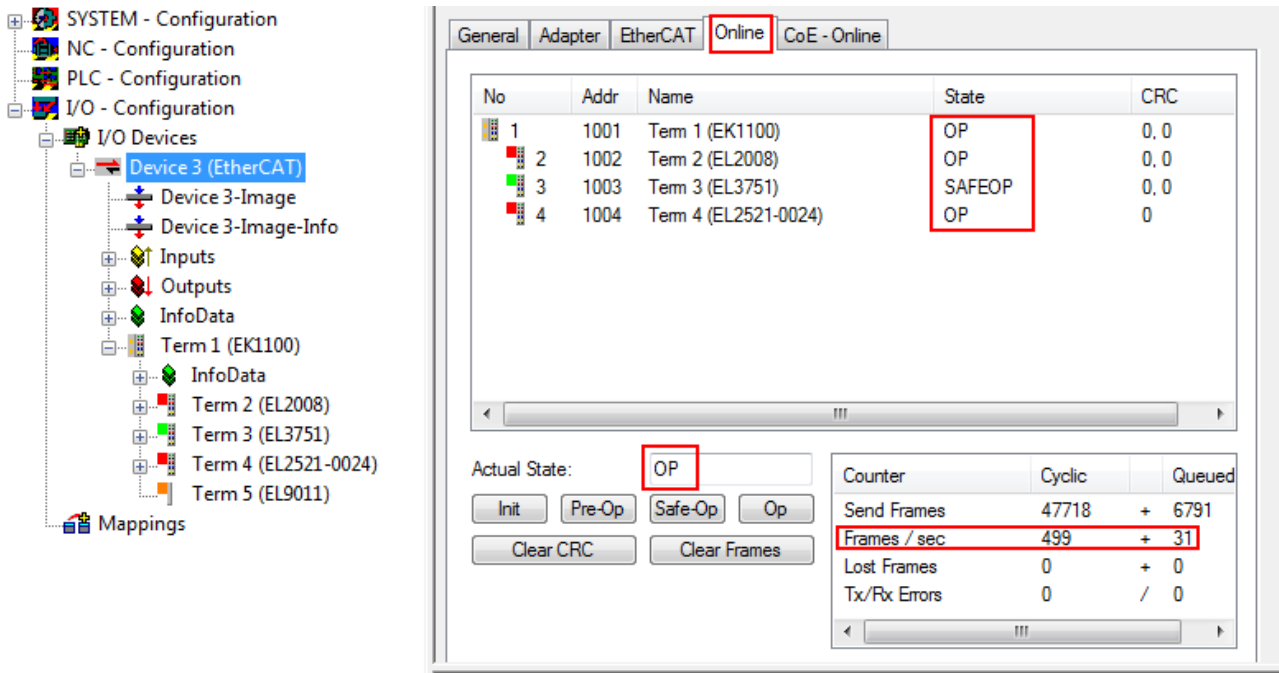

Fig. 162: Online display example

Please note:

- all slaves should be in OP state
- the EtherCAT master should be in “Actual State” OP
- “frames/sec” should match the cycle time taking into account the sent number of frames
- no excessive “LostFrames” or CRC errors should occur

The configuration is now complete. It can be modified as described under [manual procedure \[► 206\]](#).

Troubleshooting

Various effects may occur during scanning.

- An **unknown device** is detected, i.e. an EtherCAT slave for which no ESI XML description is available. In this case the System Manager offers to read any ESI that may be stored in the device. This case is described in the chapter “Notes regarding ESI device description”.
- **Device are not detected properly**
Possible reasons include:
 - faulty data links, resulting in data loss during the scan
 - slave has invalid device description

The connections and devices should be checked in a targeted manner, e.g. via the emergency scan. Then re-run the scan.

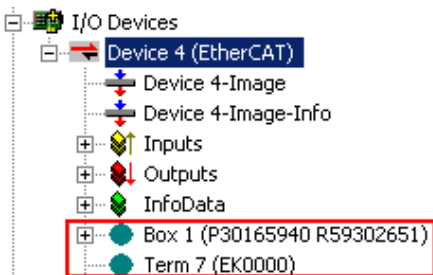

Fig. 163: Faulty identification

In the System Manager such devices may be set up as EK0000 or unknown devices. Operation is not possible or meaningful.

Scan over existing Configuration

NOTICE

Change of the configuration after comparison

With this scan (TwinCAT 2.11 or 3.1) only the device properties vendor (manufacturer), device name and revision are compared at present! A “ChangeTo” or “Copy” should only be carried out with care, taking into consideration the Beckhoff IO compatibility rule (see above). The device configuration is then replaced by the revision found; this can affect the supported process data and functions.

If a scan is initiated for an existing configuration, the actual I/O environment may match the configuration exactly or it may differ. This enables the configuration to be compared.



Fig. 164: Identical configuration (left: TwinCAT 2; right: TwinCAT 3)

If differences are detected, they are shown in the correction dialog, so that the user can modify the configuration as required.

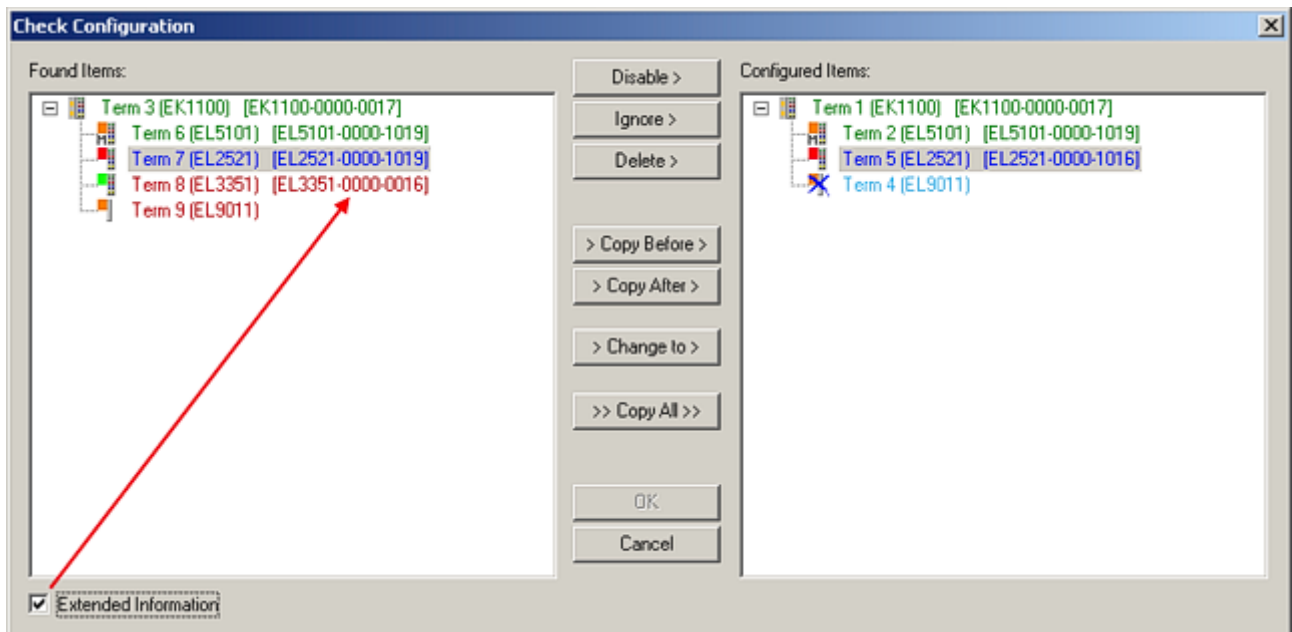

Fig. 165: Correction dialog

It is advisable to tick the “Extended Information” check box to reveal differences in the revision.

Color	Explanation
green	This EtherCAT slave matches the entry on the other side. Both type and revision match.
blue	This EtherCAT slave is present on the other side, but in a different revision. This other revision can have other default values for the process data as well as other/additional functions. If the found revision is higher than the configured revision, the slave may be used provided compatibility issues are taken into account. If the found revision is lower than the configured revision, it is likely that the slave cannot be used. The found device may not support all functions that the master expects based on the higher revision number.
light blue	This EtherCAT slave is ignored ("Ignore" button)
red	<ul style="list-style-type: none"> This EtherCAT slave is not present on the other side. It is present, but in a different revision, which also differs in its properties from the one specified. The compatibility principle then also applies here: if the found revision is higher than the configured revision, use is possible provided compatibility issues are taken into account, since the successor devices should support the functions of the predecessor devices. If the found revision is lower than the configured revision, it is likely that the slave cannot be used. The found device may not support all functions that the master expects based on the higher revision number.

i Device selection based on revision, compatibility

The ESI description also defines the process image, the communication type between master and slave/device and the device functions, if applicable. The physical device (firmware, if available) has to support the communication queries/settings of the master. This is backward compatible, i.e. newer devices (higher revision) should be supported if the EtherCAT master addresses them as an older revision. The following compatibility rule of thumb is to be assumed for Beckhoff EtherCAT Terminals/ Boxes/ EJ-modules:

device revision in the system >= device revision in the configuration

This also enables subsequent replacement of devices without changing the configuration (different specifications are possible for drives).

Example

If an EL2521-0025-**1018** is specified in the configuration, an EL2521-0025-**1018** or higher (**-1019, -1020**) can be used in practice.

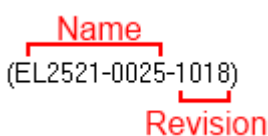

Fig. 166: Name/revision of the terminal

If current ESI descriptions are available in the TwinCAT system, the last revision offered in the selection dialog matches the Beckhoff state of production. It is recommended to use the last device revision when creating a new configuration, if current Beckhoff devices are used in the real application. Older revisions should only be used if older devices from stock are to be used in the application.

In this case the process image of the device is shown in the configuration tree and can be parameterized as follows: linking with the task, CoE/DC settings, plug-in definition, startup settings, ...

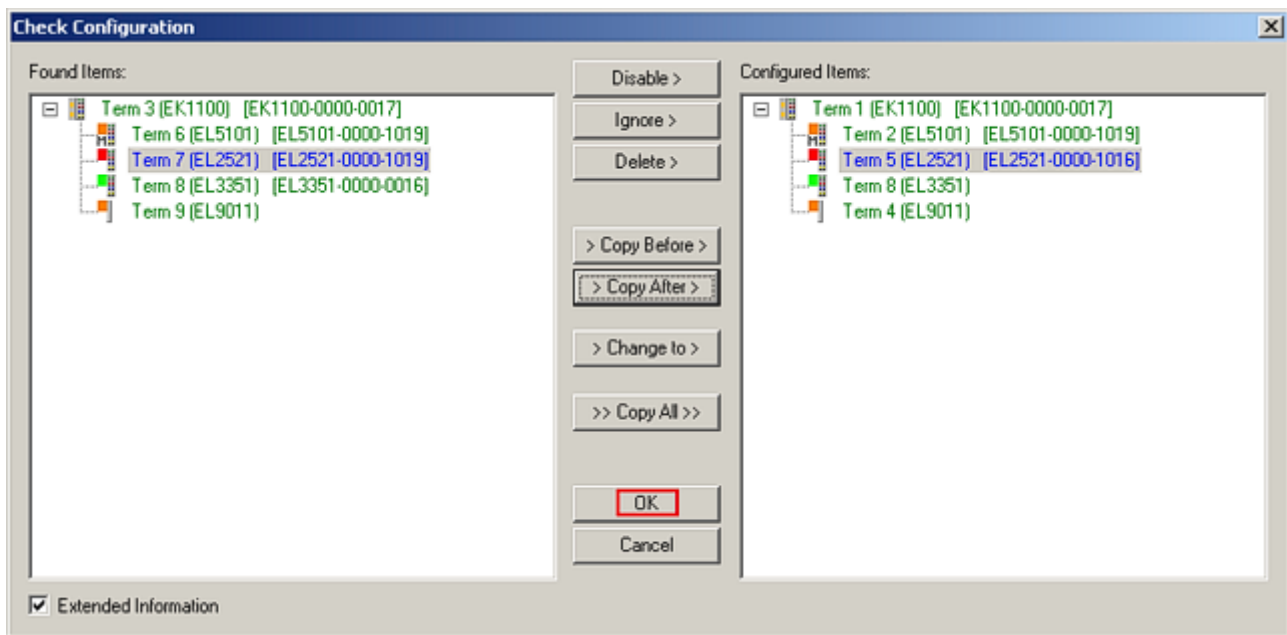

Fig. 167: Correction dialog with modifications

Once all modifications have been saved or accepted, click “OK” to transfer them to the real *.tsm configuration.

Change to Compatible Type

TwinCAT offers a function *Change to Compatible Type...* for the exchange of a device whilst retaining the links in the task.

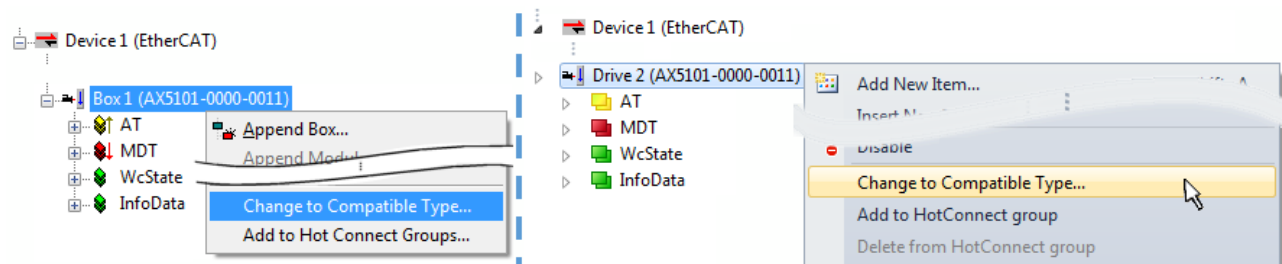

Fig. 168: Dialog “Change to Compatible Type...” (left: TwinCAT 2; right: TwinCAT 3)

The following elements in the ESI of an EtherCAT device are compared by TwinCAT and assumed to be the same in order to decide whether a device is indicated as “compatible”:

- Physics (e.g. RJ45, Ebus...)
- FMMU (additional ones are allowed)
- SyncManager (SM, additional ones are allowed)
- EoE (attributes MAC, IP)
- CoE (attributes SdoInfo, PdoAssign, PdoConfig, PdoUpload, CompleteAccess)
- FoE
- PDO (process data: Sequence, SyncUnit SU, SyncManager SM, EntryCount, Entry.Datatype)

This function is preferably to be used on AX5000 devices.

Change to Alternative Type

The TwinCAT System Manager offers a function for the exchange of a device: Change to Alternative Type

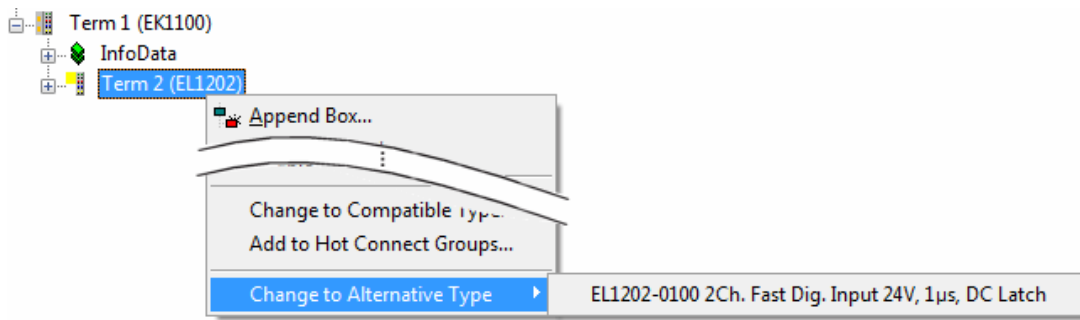

Fig. 169: TwinCAT 2 Dialog Change to Alternative Type

If called, the System Manager searches in the procured device ESI (in this example: EL1202-0000) for details of compatible devices contained there. The configuration is changed and the ESI-EEPROM is overwritten at the same time – therefore this process is possible only in the online state (ConfigMode).

5.2.7 EtherCAT subscriber configuration

In the left-hand window of the TwinCAT 2 System Manager or the Solution Explorer of the TwinCAT 3 Development Environment respectively, click on the element of the terminal within the tree you wish to configure (in the example: EL3751 Terminal 3).

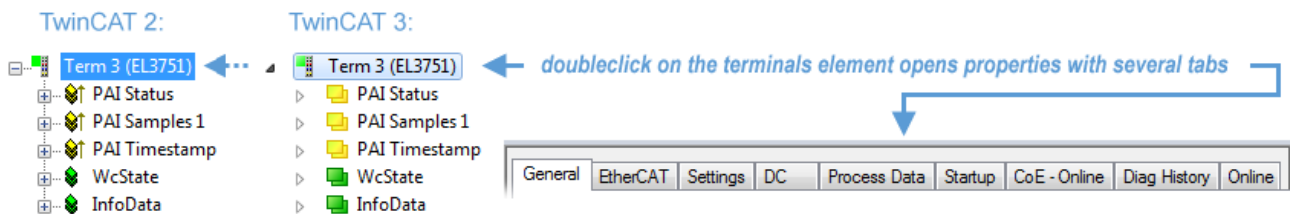

Fig. 170: Branch element as terminal EL3751

In the right-hand window of the TwinCAT System Manager (TwinCAT 2) or the Development Environment (TwinCAT 3), various tabs are now available for configuring the terminal. And yet the dimension of complexity of a subscriber determines which tabs are provided. Thus as illustrated in the example above the terminal EL3751 provides many setup options and also a respective number of tabs are available. On the contrary by the terminal EL1004 for example the tabs “General”, “EtherCAT”, “Process Data” and “Online” are available only. Several terminals, as for instance the EL6695 provide special functions by a tab with its own terminal name, so “EL6695” in this case. A specific tab “Settings” by terminals with a wide range of setup options will be provided also (e.g. EL3751).

“General” tab

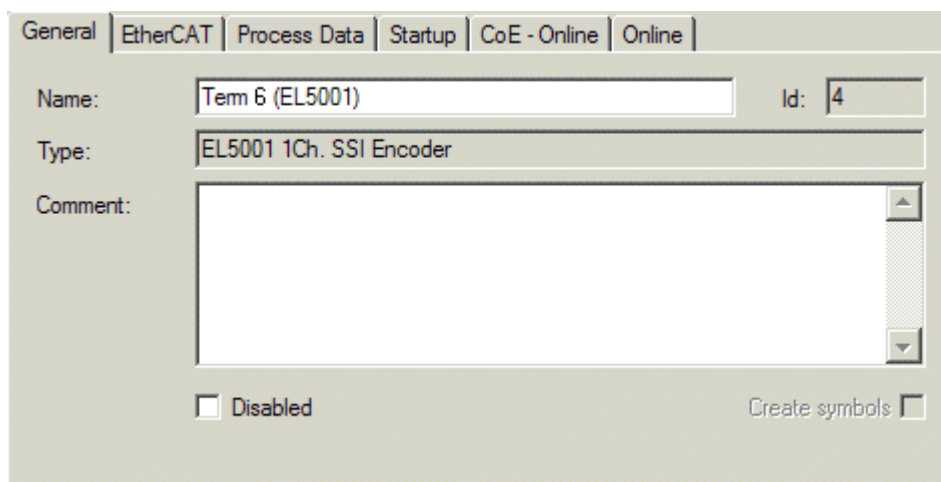

Fig. 171: “General” tab

Name	Name of the EtherCAT device
Id	Number of the EtherCAT device
Type	EtherCAT device type
Comment	Here you can add a comment (e.g. regarding the system).
Disabled	Here you can deactivate the EtherCAT device.
Create symbols	Access to this EtherCAT slave via ADS is only available if this control box is activated.

“EtherCAT” tab

Fig. 172: “EtherCAT” tab

Type	EtherCAT device type
Product/Revision	Product and revision number of the EtherCAT device
Auto Inc Addr.	Auto increment address of the EtherCAT device. The auto increment address can be used for addressing each EtherCAT device in the communication ring through its physical position. Auto increment addressing is used during the start-up phase when the EtherCAT master allocates addresses to the EtherCAT devices. With auto increment addressing the first EtherCAT slave in the ring has the address 0000 _{hex} . For each further slave the address is decremented by 1 (FFFF _{hex} , FFFE _{hex} etc.).
EtherCAT Addr.	Fixed address of an EtherCAT slave. This address is allocated by the EtherCAT master during the start-up phase. Tick the control box to the left of the input field in order to modify the default value.
Previous Port	Name and port of the EtherCAT device to which this device is connected. If it is possible to connect this device with another one without changing the order of the EtherCAT devices in the communication ring, then this combination field is activated and the EtherCAT device to which this device is to be connected can be selected.
Advanced Settings	This button opens the dialogs for advanced settings.

The link at the bottom of the tab points to the product page for this EtherCAT device on the web.

“Process Data” tab

Indicates the configuration of the process data. The input and output data of the EtherCAT slave are represented as CANopen process data objects (**Process Data Objects**, PDOs). The user can select a PDO via PDO assignment and modify the content of the individual PDO via this dialog, if the EtherCAT slave supports this function.

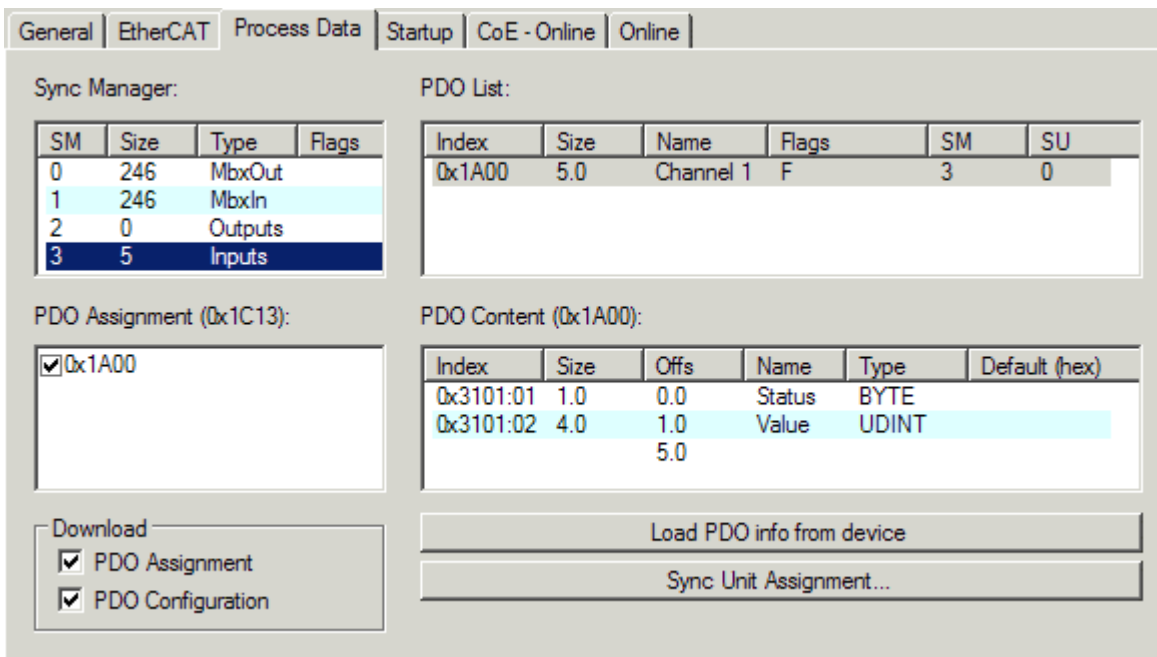

Fig. 173: "Process Data" tab

The process data (PDOs) transferred by an EtherCAT slave during each cycle are user data which the application expects to be updated cyclically or which are sent to the slave. To this end the EtherCAT master (Beckhoff TwinCAT) parameterizes each EtherCAT slave during the start-up phase to define which process data (size in bits/bytes, source location, transmission type) it wants to transfer to or from this slave. Incorrect configuration can prevent successful start-up of the slave.

For Beckhoff EtherCAT EL, ES, EM, EJ and EP slaves the following applies in general:

- The input/output process data supported by the device are defined by the manufacturer in the ESI/XML description. The TwinCAT EtherCAT Master uses the ESI description to configure the slave correctly.
- The process data can be modified in the System Manager. See the device documentation. Examples of modifications include: mask out a channel, displaying additional cyclic information, 16-bit display instead of 8-bit data size, etc.
- In so-called "intelligent" EtherCAT devices the process data information is also stored in the CoE directory. Any changes in the CoE directory that lead to different PDO settings prevent successful startup of the slave. It is not advisable to deviate from the designated process data, because the device firmware (if available) is adapted to these PDO combinations.

If the device documentation allows modification of process data, proceed as follows (see Figure *Configuring the process data*).

- A: select the device to configure
- B: in the "Process Data" tab select Input or Output under SyncManager (C)
- D: the PDOs can be selected or deselected
- H: the new process data are visible as linkable variables in the System Manager
The new process data are active once the configuration has been activated and TwinCAT has been restarted (or the EtherCAT master has been restarted)
- E: if a slave supports this, Input and Output PDO can be modified simultaneously by selecting a so-called PDO record ("predefined PDO settings").

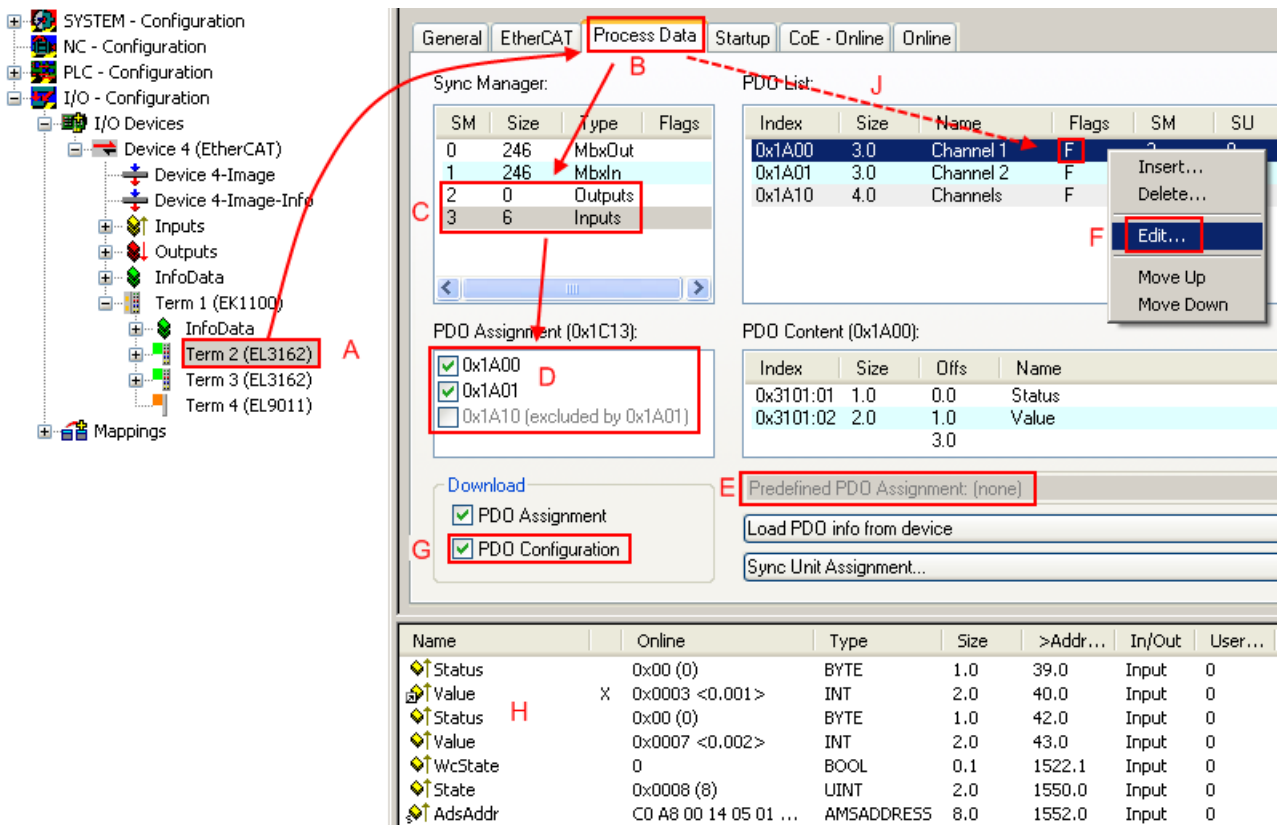

Fig. 174: Configuring the process data

i Manual modification of the process data

According to the ESI description, a PDO can be identified as “fixed” with the flag “F” in the PDO overview (Fig. *Configuring the process data*, J). The configuration of such PDOs cannot be changed, even if TwinCAT offers the associated dialog (“Edit”). In particular, CoE content cannot be displayed as cyclic process data. This generally also applies in cases where a device supports download of the PDO configuration, “G”. In case of incorrect configuration the EtherCAT slave usually refuses to start and change to OP state. The System Manager displays an “invalid SM cfg” logger message: This error message (“invalid SM IN cfg” or “invalid SM OUT cfg”) also indicates the reason for the failed start.

A detailed description [▶ 227] can be found at the end of this section.

“Startup” tab

The *Startup* tab is displayed if the EtherCAT slave has a mailbox and supports the *CANopen over EtherCAT* (CoE) or *Servo drive over EtherCAT* protocol. This tab indicates which download requests are sent to the mailbox during startup. It is also possible to add new mailbox requests to the list display. The download requests are sent to the slave in the same order as they are shown in the list.

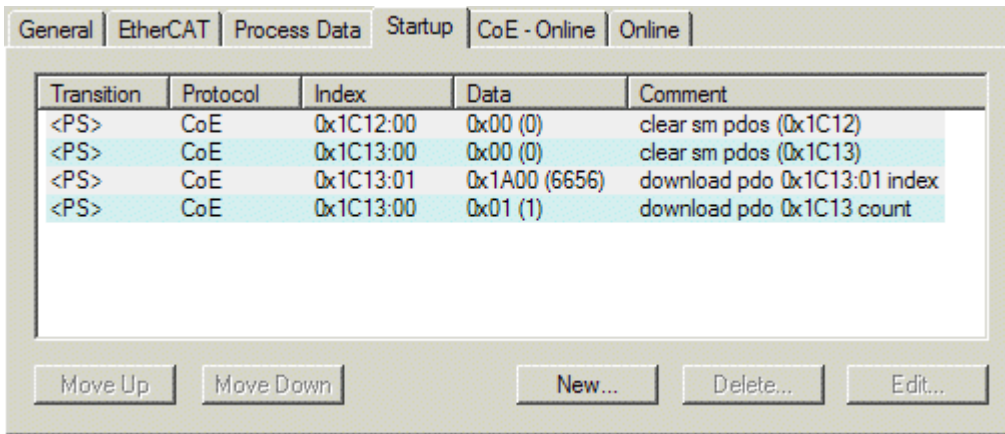

Fig. 175: "Startup" tab

Column	Description
Transition	Transition to which the request is sent. This can either be <ul style="list-style-type: none"> the transition from pre-operational to safe-operational (PS), or the transition from safe-operational to operational (SO). If the transition is enclosed in "<>" (e.g. <PS>), the mailbox request is fixed and cannot be modified or deleted by the user.
Protocol	Type of mailbox protocol
Index	Index of the object
Data	Date on which this object is to be downloaded.
Comment	Description of the request to be sent to the mailbox

- Move Up** This button moves the selected request up by one position in the list.
- Move Down** This button moves the selected request down by one position in the list.
- New** This button adds a new mailbox download request to be sent during startup.
- Delete** This button deletes the selected entry.
- Edit** This button edits an existing request.

"CoE - Online" tab

The additional *CoE - Online* tab is displayed if the EtherCAT slave supports the *CANopen over EtherCAT* (CoE) protocol. This dialog lists the content of the object list of the slave (SDO upload) and enables the user to modify the content of an object from this list. Details for the objects of the individual EtherCAT devices can be found in the device-specific object descriptions.

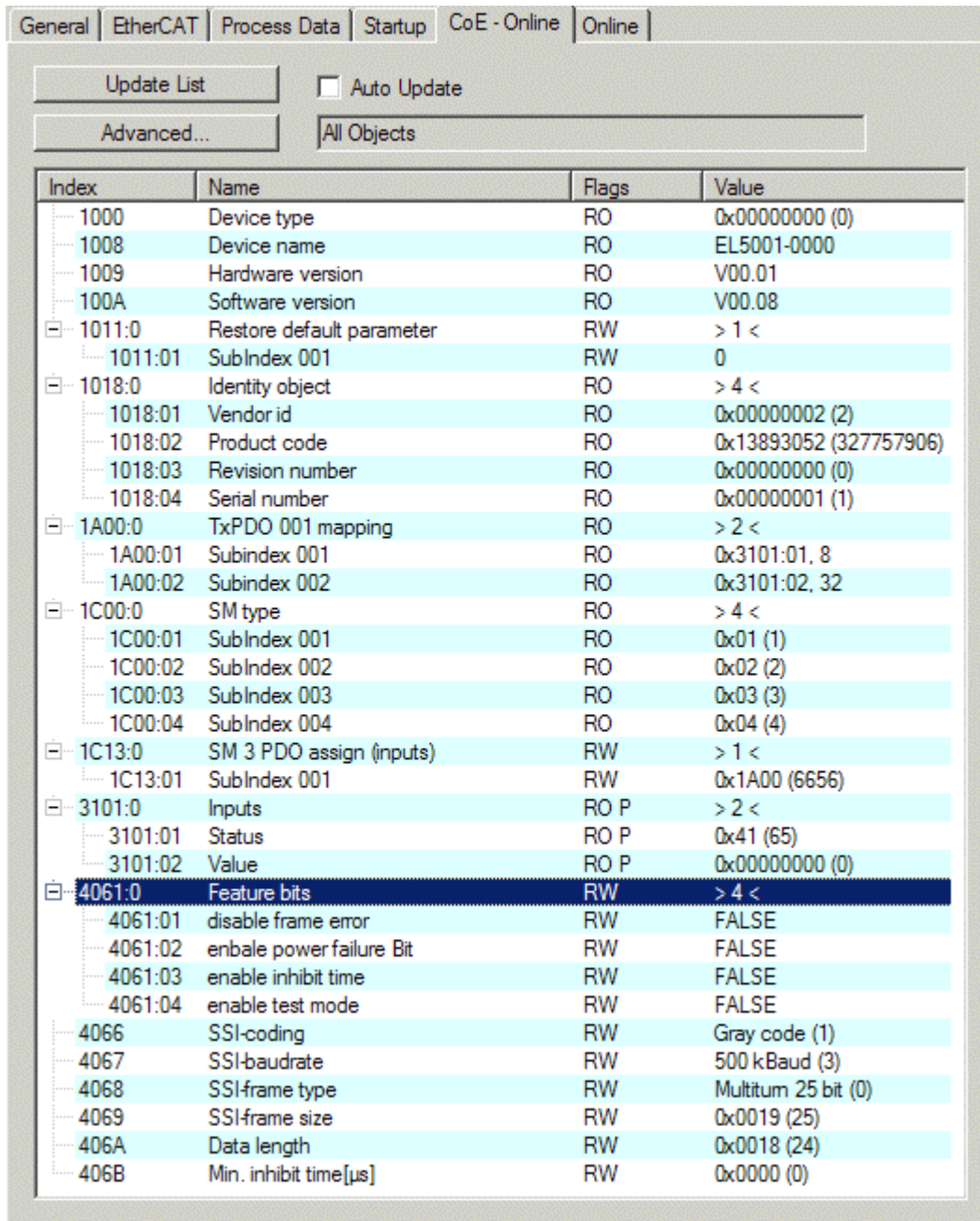

Fig. 176: "CoE - Online" tab

Object list display

Column	Description
Index	Index and sub-index of the object
Name	Name of the object
Flags	RW The object can be read, and data can be written to the object (read/write)
	RO The object can be read, but no data can be written to the object (read only)
	P An additional P identifies the object as a process data object.
Value	Value of the object

- Update List** The *Update list* button updates all objects in the displayed list
- Auto Update** If this check box is selected, the content of the objects is updated automatically.
- Advanced** The *Advanced* button opens the *Advanced Settings* dialog. Here you can specify which objects are displayed in the list.

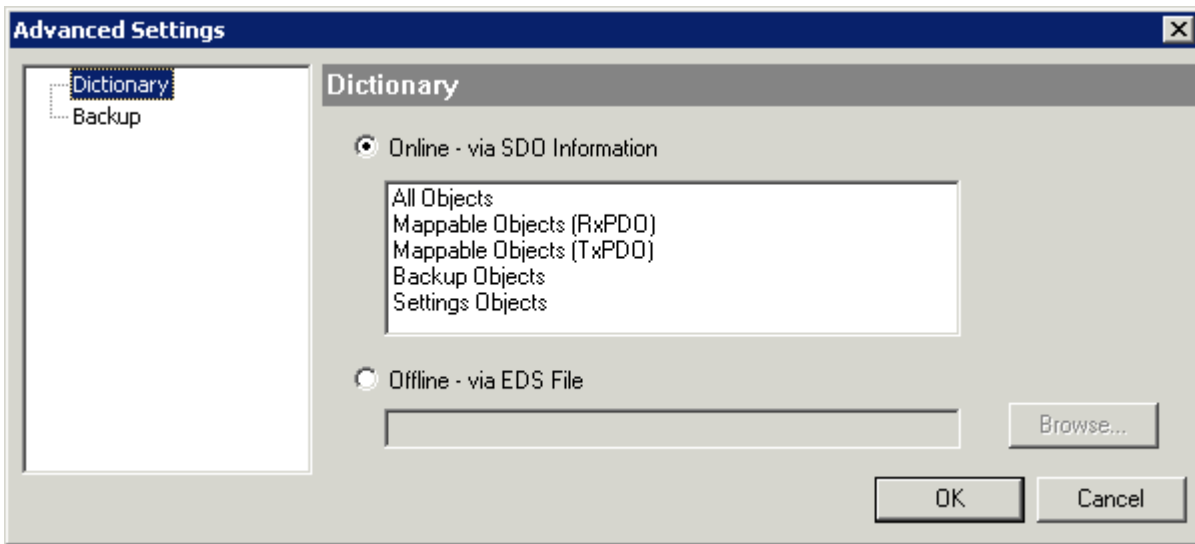

Fig. 177: Dialog “Advanced settings”

Online - via SDO Information If this option button is selected, the list of the objects included in the object list of the slave is uploaded from the slave via SDO information. The list below can be used to specify which object types are to be uploaded.

Offline - via EDS File If this option button is selected, the list of the objects included in the object list is read from an EDS file provided by the user.

“Online” tab

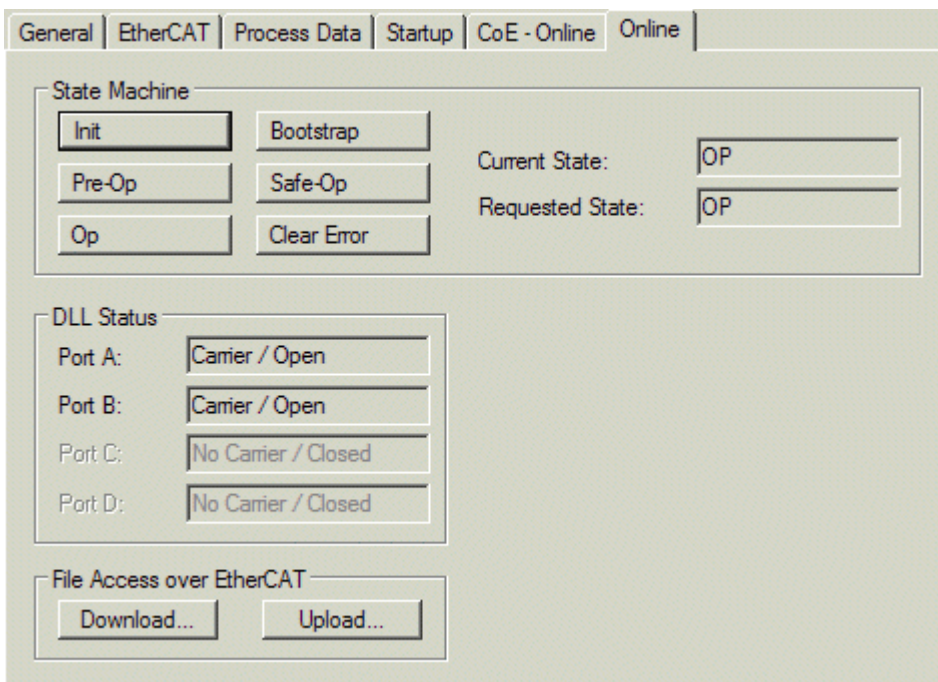

Fig. 178: “Online” tab

State Machine

Init	This button attempts to set the EtherCAT device to the <i>Init</i> state.
Pre-Op	This button attempts to set the EtherCAT device to the <i>pre-operational</i> state.
Op	This button attempts to set the EtherCAT device to the <i>operational</i> state.
Bootstrap	This button attempts to set the EtherCAT device to the <i>Bootstrap</i> state.
Safe-Op	This button attempts to set the EtherCAT device to the <i>safe-operational</i> state.
Clear Error	This button attempts to delete the fault display. If an EtherCAT slave fails during change of state it sets an error flag. Example: An EtherCAT slave is in PREOP state (pre-operational). The master now requests the SAFEOP state (safe-operational). If the slave fails during change of state it sets the error flag. The current state is now displayed as ERR PREOP. When the <i>Clear Error</i> button is pressed the error flag is cleared, and the current state is displayed as PREOP again.
Current State	Indicates the current state of the EtherCAT device.
Requested State	Indicates the state requested for the EtherCAT device.

DLL Status

Indicates the DLL status (data link layer status) of the individual ports of the EtherCAT slave. The DLL status can have four different states:

Status	Description
No Carrier / Open	No carrier signal is available at the port, but the port is open.
No Carrier / Closed	No carrier signal is available at the port, and the port is closed.
Carrier / Open	A carrier signal is available at the port, and the port is open.
Carrier / Closed	A carrier signal is available at the port, but the port is closed.

File Access over EtherCAT

Download	With this button a file can be written to the EtherCAT device.
Upload	With this button a file can be read from the EtherCAT device.

“DC” tab (Distributed Clocks)

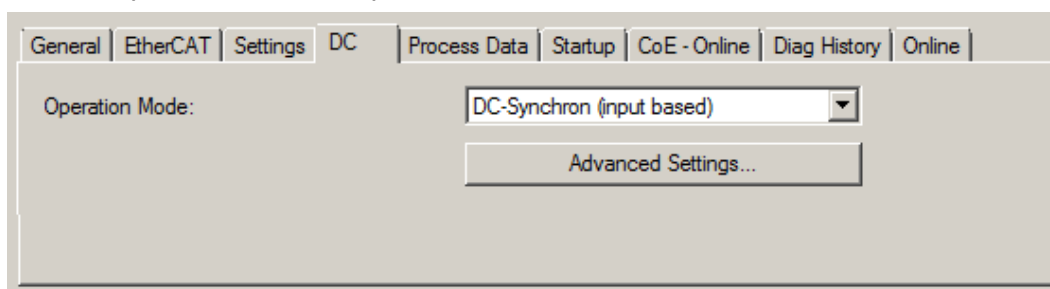

Fig. 179: “DC” tab (Distributed Clocks)

Operation Mode	Options (optional): <ul style="list-style-type: none"> • FreeRun • SM-Synchron • DC-Synchron (Input based) • DC-Synchron
Advanced Settings...	Advanced settings for readjustment of the real time determinant TwinCAT-clock

Detailed information to Distributed Clocks is specified on <http://infosys.beckhoff.com>:

Fieldbus Components → EtherCAT Terminals → EtherCAT System documentation → EtherCAT basics → Distributed Clocks

5.2.7.1 Detailed description of Process Data tab

Sync Manager

Lists the configuration of the Sync Manager (SM).

If the EtherCAT device has a mailbox, SM0 is used for the mailbox output (MbxOut) and SM1 for the mailbox input (MbxIn).

SM2 is used for the output process data (outputs) and SM3 (inputs) for the input process data.

If an input is selected, the corresponding PDO assignment is displayed in the *PDO Assignment* list below.

PDO Assignment



PDO assignment of the selected Sync Manager. All PDOs defined for this Sync Manager type are listed here:

- If the output Sync Manager (outputs) is selected in the Sync Manager list, all RxPDOs are displayed.
- If the input Sync Manager (inputs) is selected in the Sync Manager list, all TxPDOs are displayed.

The selected entries are the PDOs involved in the process data transfer. In the tree diagram of the System Manager these PDOs are displayed as variables of the EtherCAT device. The name of the variable is identical to the *Name* parameter of the PDO, as displayed in the PDO list. If an entry in the PDO assignment list is deactivated (not selected and greyed out), this indicates that the input is excluded from the PDO assignment. In order to be able to select a greyed out PDO, the currently selected PDO has to be deselected first.

i Activation of PDO assignment

- ✓ If you have changed the PDO assignment, in order to activate the new PDO assignment,
 - a) the EtherCAT slave has to run through the PS status transition cycle (from pre-operational to safe-operational) once (see [Online tab \[▶ 225\]](#)),
 - b) and the System Manager has to reload the EtherCAT slaves

( button for TwinCAT 2 or  button for TwinCAT 3)

PDO list

List of all PDOs supported by this EtherCAT device. The content of the selected PDOs is displayed in the *PDO Content* list. The PDO configuration can be modified by double-clicking on an entry.

Column	Description	
Index	PDO index.	
Size	Size of the PDO in bytes.	
Name	Name of the PDO. If this PDO is assigned to a Sync Manager, it appears as a variable of the slave with this parameter as the name.	
Flags	F	Fixed content: The content of this PDO is fixed and cannot be changed by the System Manager.
	M	Mandatory PDO. This PDO is mandatory and must therefore be assigned to a Sync Manager! Consequently, this PDO cannot be deleted from the <i>PDO Assignment</i> list
SM	Sync Manager to which this PDO is assigned. If this entry is empty, this PDO does not take part in the process data traffic.	
SU	Sync unit to which this PDO is assigned.	

PDO Content

Indicates the content of the PDO. If flag F (fixed content) of the PDO is not set the content can be modified.

Download

If the device is intelligent and has a mailbox, the configuration of the PDO and the PDO assignments can be downloaded to the device. This is an optional feature that is not supported by all EtherCAT slaves.

PDO Assignment

If this check box is selected, the PDO assignment that is configured in the PDO Assignment list is downloaded to the device on startup. The required commands to be sent to the device can be viewed in the [Startup \[► 222\]](#) tab.

PDO Configuration

If this check box is selected, the configuration of the respective PDOs (as shown in the PDO list and the PDO Content display) is downloaded to the EtherCAT slave.

5.2.8 Import/Export of EtherCAT devices with SCI and XTI

SCI and XTI Export/Import – Handling of user-defined modified EtherCAT slaves

5.2.8.1 Basic principles

An EtherCAT slave is basically parameterized through the following elements:

- Cyclic process data (PDO)
- Synchronization (Distributed Clocks, FreeRun, SM-Synchron)
- CoE parameters (acyclic object dictionary)

Note: Not all three elements may be present, depending on the slave.

For a better understanding of the export/import function, let's consider the usual procedure for IO configuration:

- The user/programmer processes the IO configuration in the TwinCAT system environment. This involves all input/output devices such as drives that are connected to the fieldbuses used.
Note: In the following sections, only EtherCAT configurations in the TwinCAT system environment are considered.
- For example, the user manually adds devices to a configuration or performs a scan on the online system.
- This results in the IO system configuration.
- On insertion, the slave appears in the system configuration in the default configuration provided by the vendor, consisting of default PDO, default synchronization method and CoE StartUp parameter as defined in the ESI (XML device description).
- If necessary, elements of the slave configuration can be changed, e.g. the PDO configuration or the synchronization method, based on the respective device documentation.

It may become necessary to reuse the modified slave in other projects in this way, without having to make equivalent configuration changes to the slave again. To accomplish this, proceed as follows:

- Export the slave configuration from the project,
- Store and transport as a file,
- Import into another EtherCAT project.

TwinCAT offers two methods for this purpose:

- within the TwinCAT environment: Export/Import as **x**ti file or
- outside, i.e. beyond the TwinCAT limits: Export/Import as **s**ci file.

An example is provided below for illustration purposes: an EL3702 terminal with standard setting is switched to 2-fold oversampling (blue) and the optional PDO "StartTimeNextLatch" is added (red):

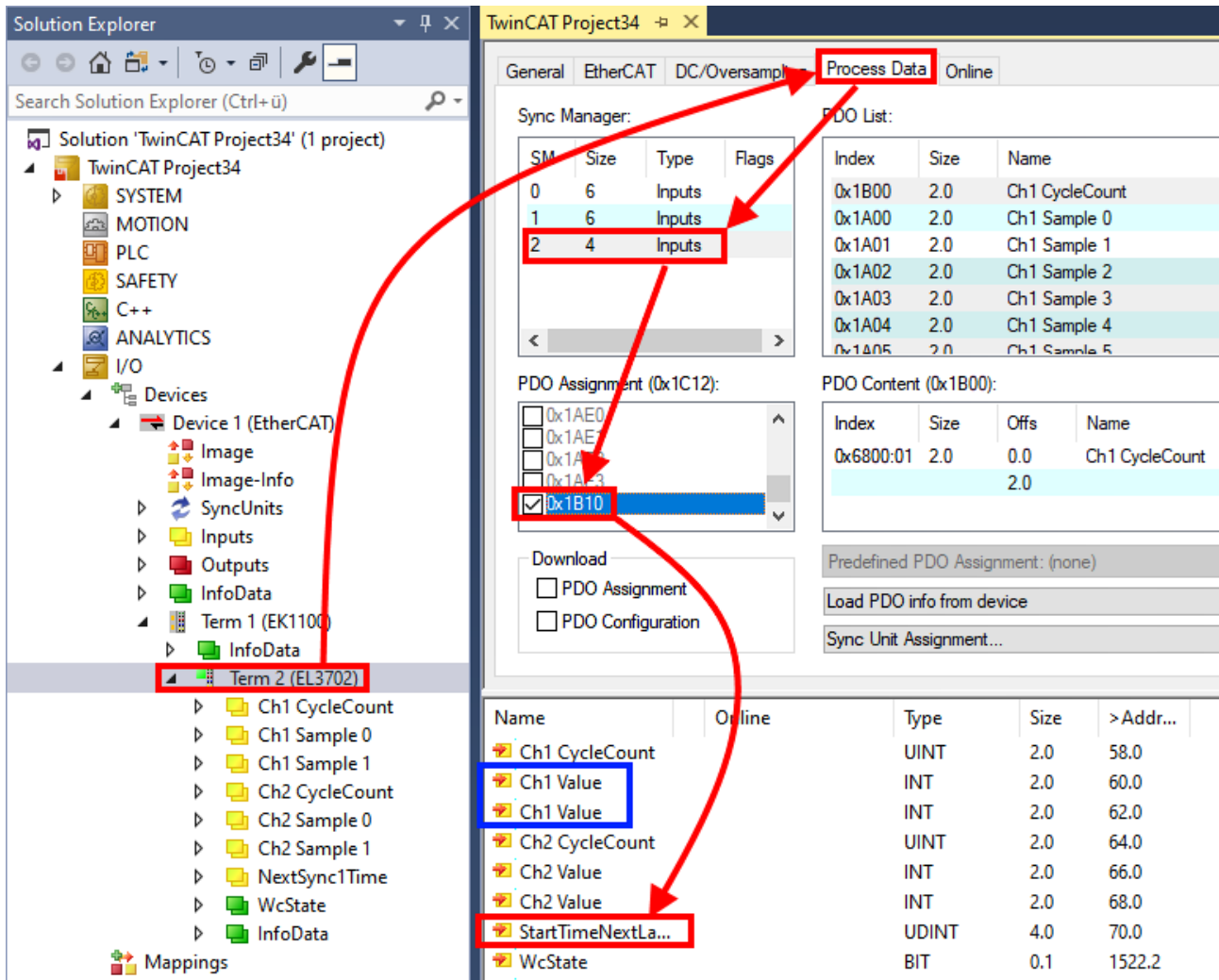

The two methods for exporting and importing the modified terminal referred to above are demonstrated below.

5.2.8.2 Procedure within TwinCAT with xti files

Each IO device can be exported/saved individually:

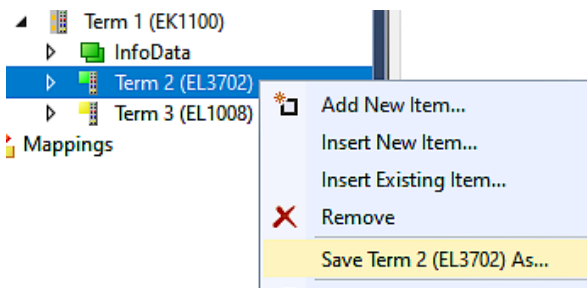

The xti file can be stored:

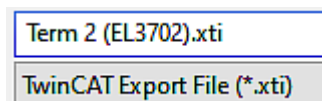

and imported again in another TwinCAT system via "Insert Existing item":

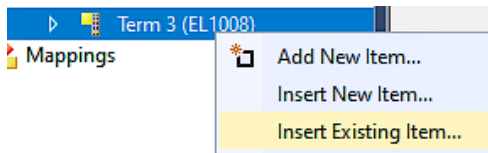

5.2.8.3 Procedure within and outside TwinCAT with sci file

Note regarding availability (2021/01)

The SCI method is available from TwinCAT 3.1 build 4024.14.

The Slave Configuration Information (SCI) describes a specific complete configuration for an EtherCAT slave (terminal, box, drive...) based on the setting options of the device description file (ESI, EtherCAT Slave Information). That is, it includes PDO, CoE, synchronization.

Export:

- select a single device via the menu (multiple selection is also possible):
TwinCAT → EtherCAT Devices → Export SCI.

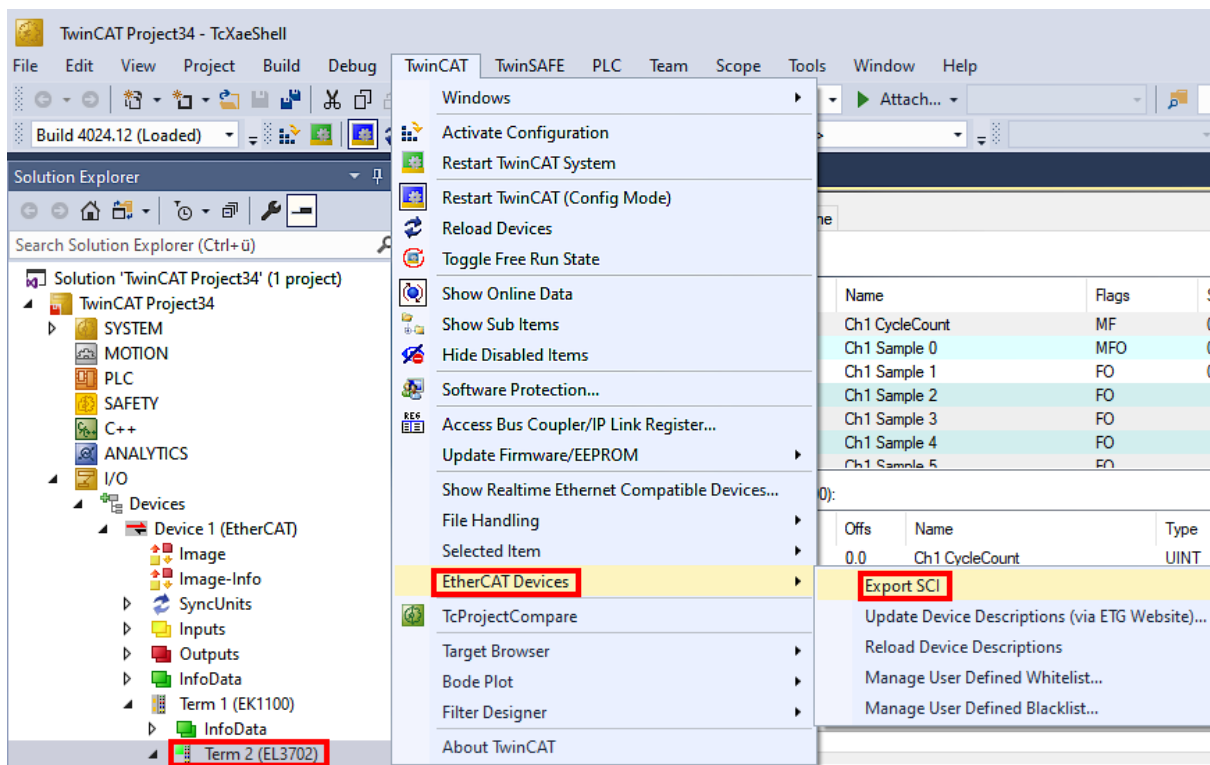

- If TwinCAT is offline (i.e. if there is no connection to an actual running controller) a warning message may appear, because after executing the function the system attempts to reload the EtherCAT segment. However, in this case this is not relevant for the result and can be acknowledged by clicking OK:

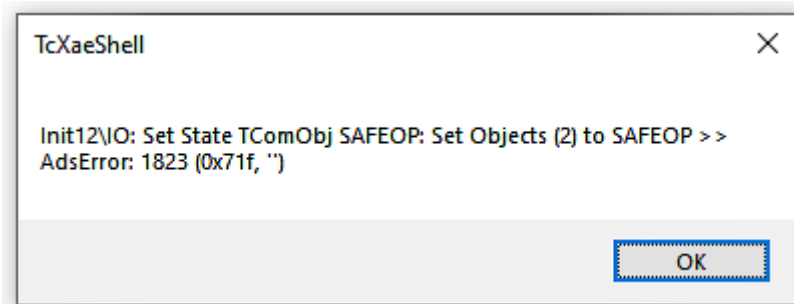

- A description may also be provided:

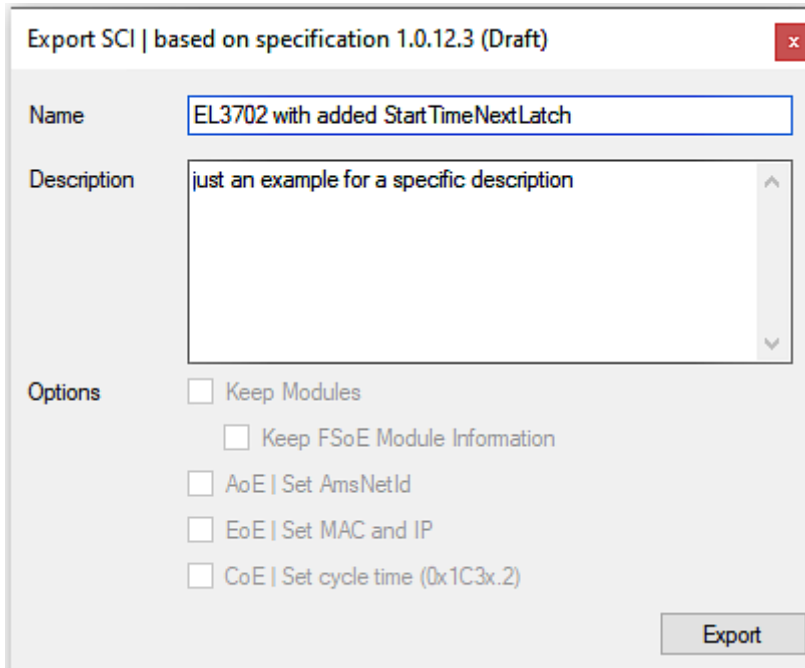

- Explanation of the dialog box:

Name	Name of the SCI, assigned by the user.	
Description	Description of the slave configuration for the use case, assigned by the user.	
Options	Keep modules	If a slave supports modules/slots, the user can decide whether these are to be exported or whether the module and device data are to be combined during export.
	AoE Set AmsNetId	The configured AmsNetId is exported. Usually this is network-dependent and cannot always be determined in advance.
	EoE Set MAC and IP	The configured virtual MAC and IP addresses are stored in the SCI. Usually these are network-dependent and cannot always be determined in advance.
	CoE Set cycle time(0x1C3x.2)	The configured cycle time is exported. Usually this is network-dependent and cannot always be determined in advance.
ESI	Reference to the original ESI file.	
Export	Save SCI file.	

- A list view is available for multiple selections (*Export multiple SCI files*):

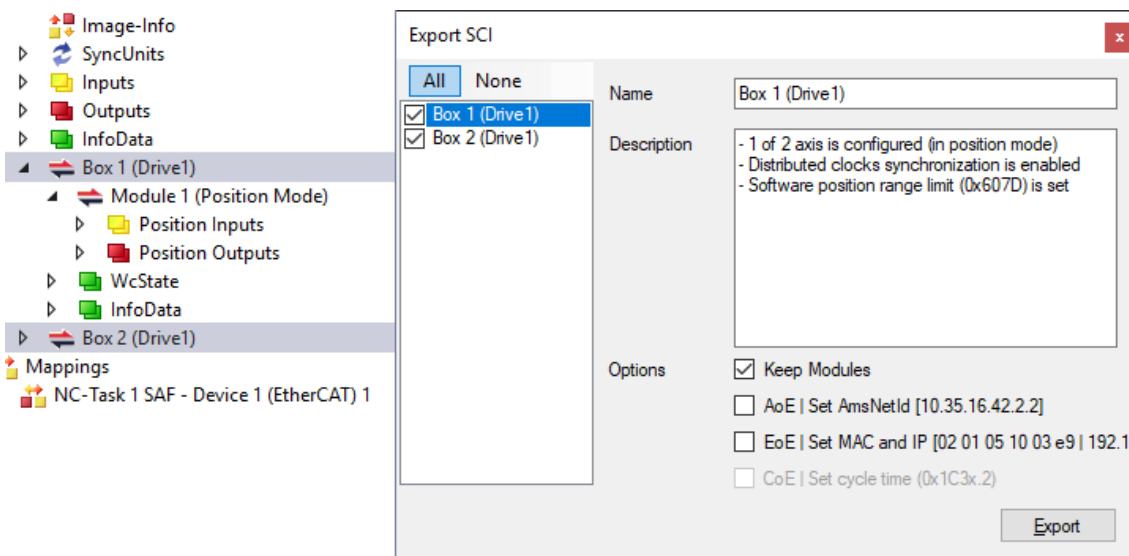

- Selection of the slaves to be exported:
 - All:
 - All slaves are selected for export.

- None:
All slaves are deselected.
- The sci file can be saved locally:

Dateiname:
 Dateityp:

- The export takes place:

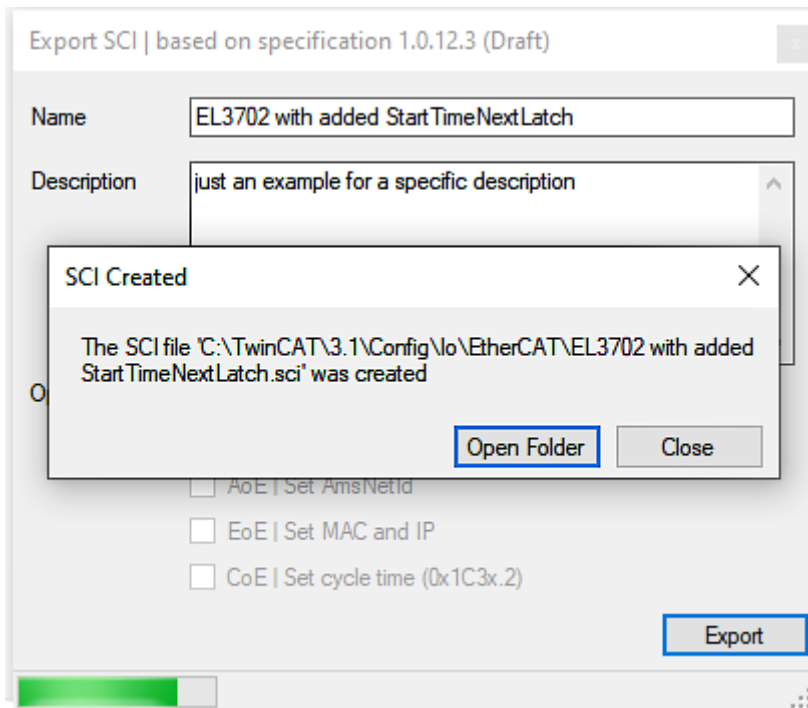

Import

- An sci description can be inserted manually into the TwinCAT configuration like any normal Beckhoff device description.
- The sci file must be located in the TwinCAT ESI path, usually under:
C:\TwinCAT\3.1\Config\Io\EtherCAT

	EL3702 with added StartTimeNextLatch.sci	11.01.2021 13:29	SCI-Datei	6 KB
--	--	------------------	-----------	------

- Open the selection dialog:

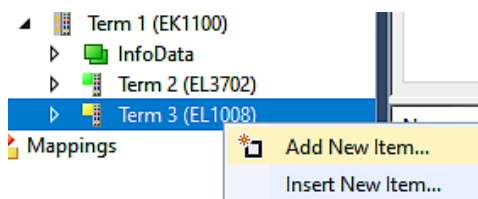

- Display SCI devices and select and insert the desired device:

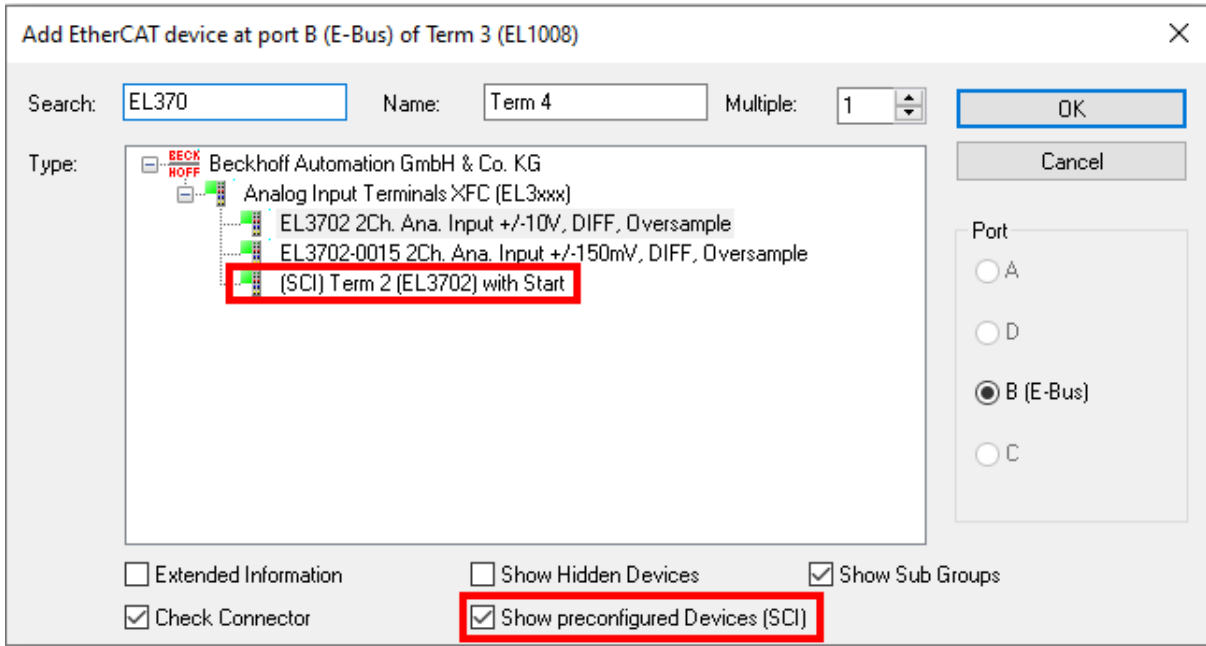

Additional Notes

- Settings for the SCI function can be made via the general Options dialog (Tools → Options → TwinCAT → Export SCI):

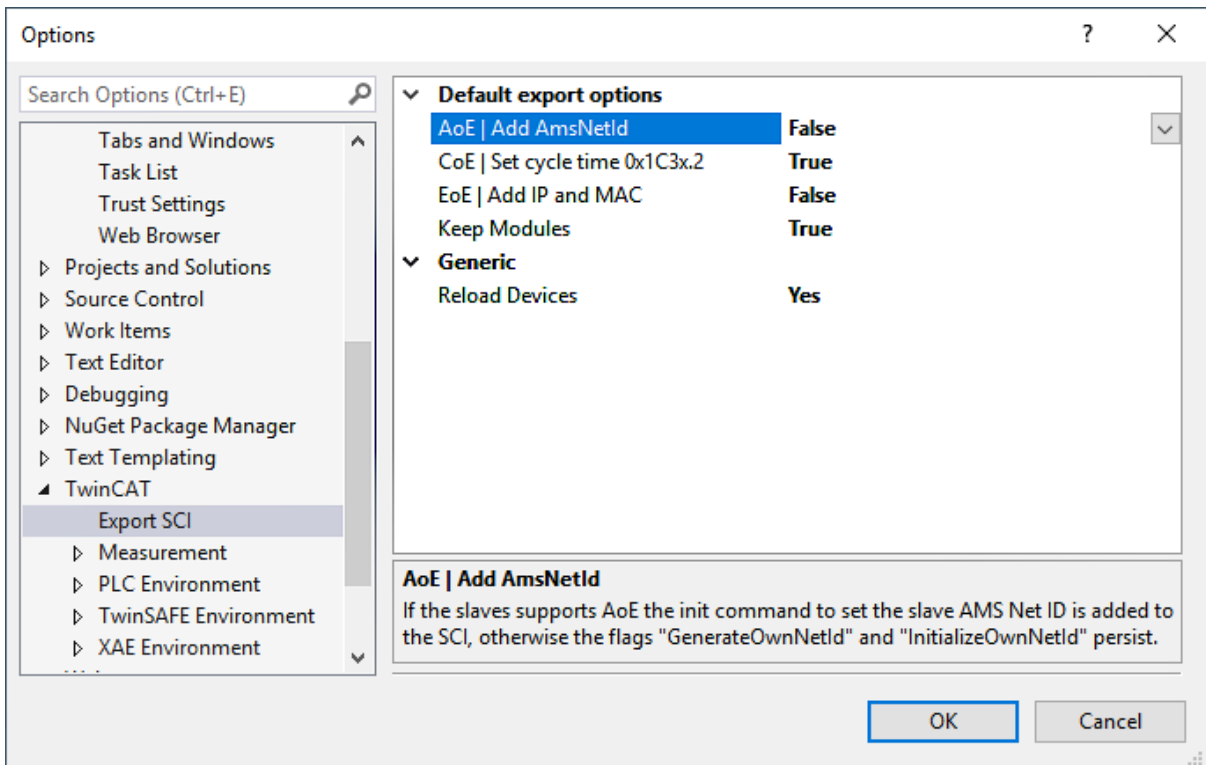

Explanation of the settings:

Default export options	AoE Set AmsNetId	Default setting whether the configured AmsNetId is exported.
	CoE Set cycle time(0x1C3x.2)	Default setting whether the configured cycle time is exported.
	EoE Set MAC and IP	Default setting whether the configured MAC and IP addresses are exported.
	Keep modules	Default setting whether the modules persist.
Generic	Reload Devices	Setting whether the Reload Devices command is executed before the SCI export. This is strongly recommended to ensure a consistent slave configuration.

SCI error messages are displayed in the TwinCAT logger output window if required:

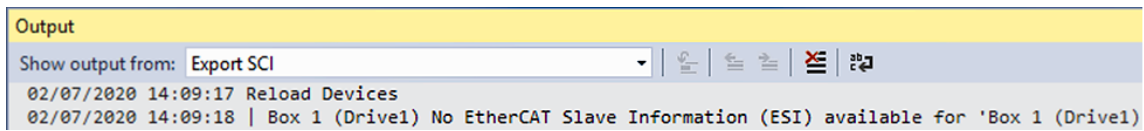

5.3 General Commissioning Instructions for an EtherCAT Slave

This summary briefly deals with a number of aspects of EtherCAT Slave operation under TwinCAT. More detailed information on this may be found in the corresponding sections of, for instance, the [EtherCAT System Documentation](#).

Diagnosis in real time: WorkingCounter, EtherCAT State and Status

Generally speaking an EtherCAT Slave provides a variety of diagnostic information that can be used by the controlling task.

This diagnostic information relates to differing levels of communication. It therefore has a variety of sources, and is also updated at various times.

Any application that relies on I/O data from a fieldbus being correct and up to date must make diagnostic access to the corresponding underlying layers. EtherCAT and the TwinCAT System Manager offer comprehensive diagnostic elements of this kind. Those diagnostic elements that are helpful to the controlling task for diagnosis that is accurate for the current cycle when in operation (not during commissioning) are discussed below.

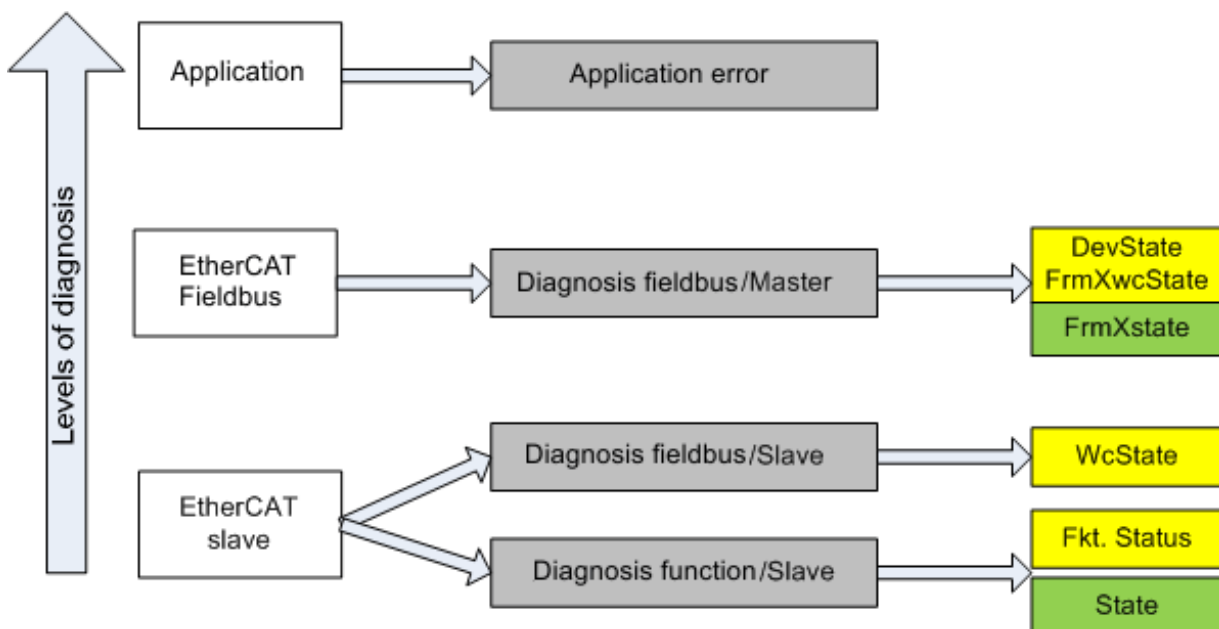

Fig. 180: Selection of the diagnostic information of an EtherCAT Slave

In general, an EtherCAT Slave offers

- communication diagnosis typical for a slave (diagnosis of successful participation in the exchange of process data, and correct operating mode)
This diagnosis is the same for all slaves.

as well as

- function diagnosis typical for a channel (device-dependent)
See the corresponding device documentation

The colors in Fig. *Selection of the diagnostic information of an EtherCAT Slave* also correspond to the variable colors in the System Manager, see Fig. *Basic EtherCAT Slave Diagnosis in the PLC*.

Colour	Meaning
yellow	Input variables from the Slave to the EtherCAT Master, updated in every cycle
red	Output variables from the Slave to the EtherCAT Master, updated in every cycle
green	Information variables for the EtherCAT Master that are updated acyclically. This means that it is possible that in any particular cycle they do not represent the latest possible status. It is therefore useful to read such variables through ADS.

Fig. Basic EtherCAT Slave Diagnosis in the PLC shows an example of an implementation of basic EtherCAT Slave Diagnosis. A Beckhoff EL3102 (2-channel analogue input terminal) is used here, as it offers both the communication diagnosis typical of a slave and the functional diagnosis that is specific to a channel. Structures are created as input variables in the PLC, each corresponding to the process image.

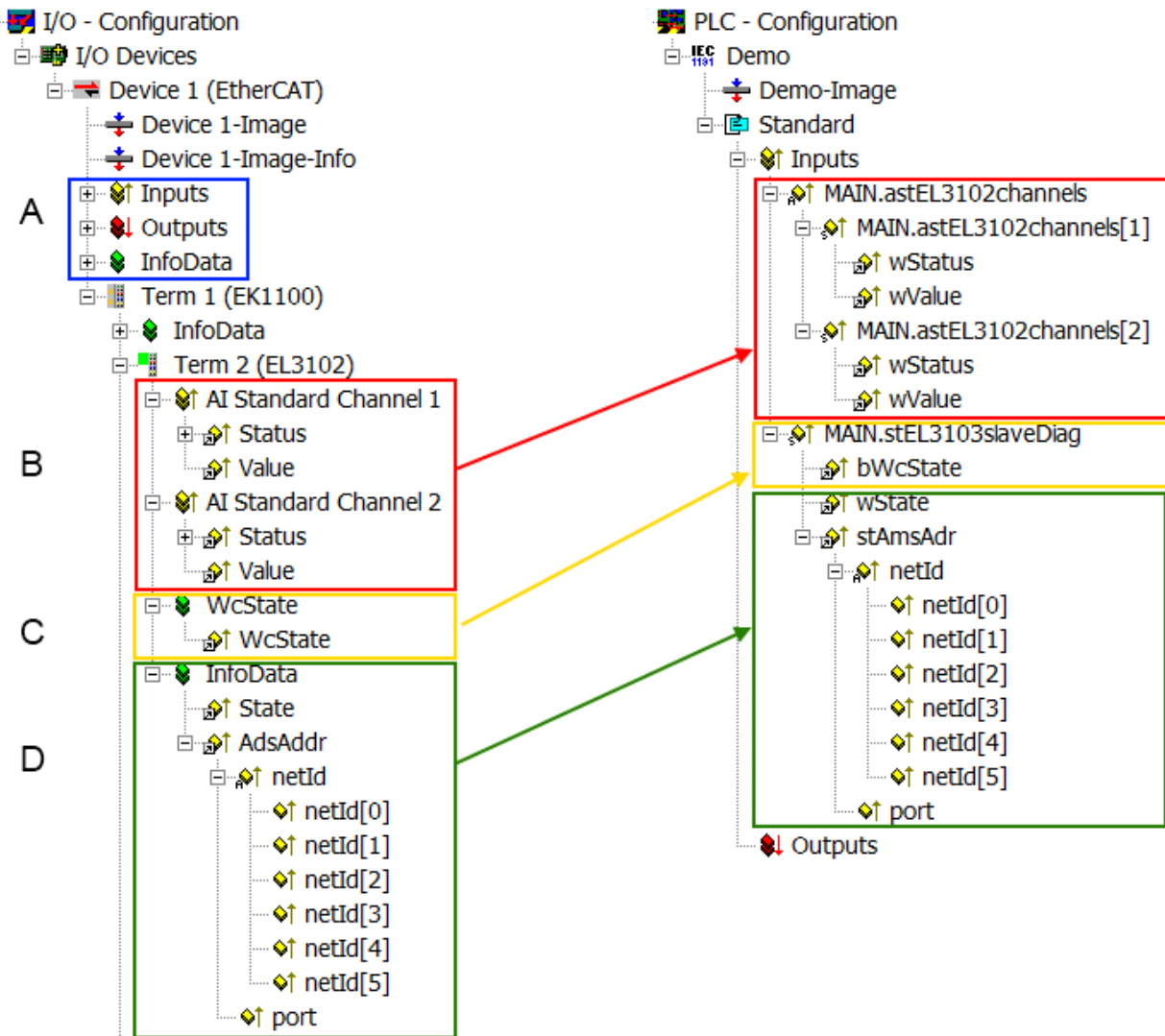

Fig. 181: Basic EtherCAT Slave Diagnosis in the PLC

The following aspects are covered here:

Code	Function	Implementation	Application/evaluation
A	The EtherCAT Master's diagnostic information updated acyclically (yellow) or provided acyclically (green).		At least the DevState is to be evaluated for the most recent cycle in the PLC. The EtherCAT Master's diagnostic information offers many more possibilities than are treated in the EtherCAT System Documentation. A few keywords: <ul style="list-style-type: none"> • CoE in the Master for communication with/through the Slaves • Functions from <i>TcEtherCAT.lib</i> • Perform an OnlineScan
B	In the example chosen (EL3102) the EL3102 comprises two analogue input channels that transmit a single function status for the most recent cycle.	Status <ul style="list-style-type: none"> • the bit significations may be found in the device documentation • other devices may supply more information, or none that is typical of a slave 	In order for the higher-level PLC task (or corresponding control applications) to be able to rely on correct data, the function status must be evaluated there. Such information is therefore provided with the process data for the most recent cycle.
C	For every EtherCAT Slave that has cyclic process data, the Master displays, using what is known as a WorkingCounter, whether the slave is participating successfully and without error in the cyclic exchange of process data. This important, elementary information is therefore provided for the most recent cycle in the System Manager <ol style="list-style-type: none"> 1. at the EtherCAT Slave, and, with identical contents 2. as a collective variable at the EtherCAT Master (see Point A) for linking. 	WcState (Working Counter) 0: valid real-time communication in the last cycle 1: invalid real-time communication This may possibly have effects on the process data of other Slaves that are located in the same SyncUnit	In order for the higher-level PLC task (or corresponding control applications) to be able to rely on correct data, the communication status of the EtherCAT Slave must be evaluated there. Such information is therefore provided with the process data for the most recent cycle.
D	Diagnostic information of the EtherCAT Master which, while it is represented at the slave for linking, is actually determined by the Master for the Slave concerned and represented there. This information cannot be characterized as real-time, because it <ul style="list-style-type: none"> • is only rarely/never changed, except when the system starts up • is itself determined acyclically (e.g. EtherCAT Status) 	State current Status (INIT..OP) of the Slave. The Slave must be in OP (=8) when operating normally. <i>AdsAddr</i> The ADS address is useful for communicating from the PLC/task via ADS with the EtherCAT Slave, e.g. for reading/writing to the CoE. The AMS-NetID of a slave corresponds to the AMS-NetID of the EtherCAT Master; communication with the individual Slave is possible via the <i>port</i> (= EtherCAT address).	Information variables for the EtherCAT Master that are updated acyclically. This means that it is possible that in any particular cycle they do not represent the latest possible status. It is therefore possible to read such variables through ADS.

NOTICE

Diagnostic information

It is strongly recommended that the diagnostic information made available is evaluated so that the application can react accordingly.

CoE Parameter Directory

The CoE parameter directory (CanOpen-over-EtherCAT) is used to manage the set values for the slave concerned. Changes may, in some circumstances, have to be made here when commissioning a relatively complex EtherCAT Slave. It can be accessed through the TwinCAT System Manager, see Fig. *EL3102, CoE directory*:

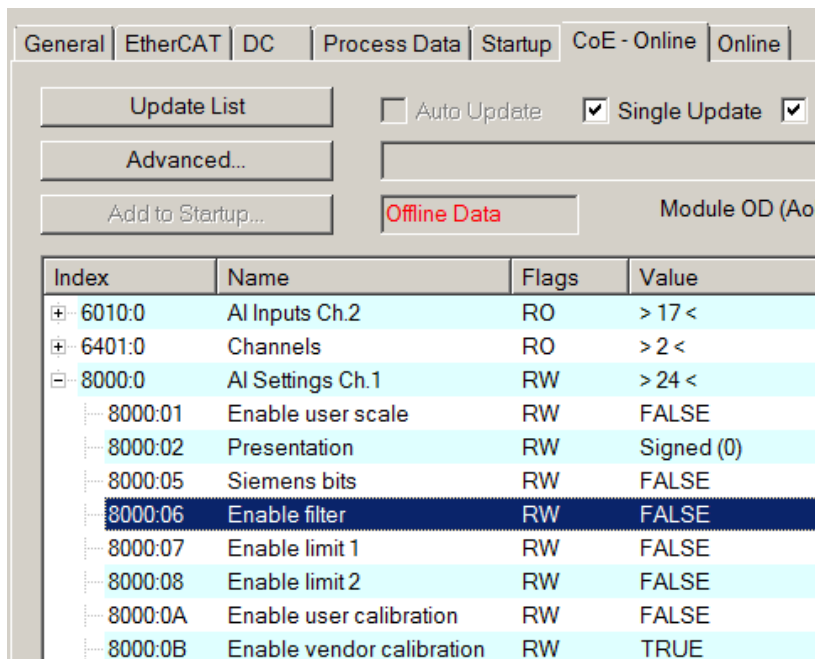

Fig. 182: EL3102, CoE directory

i EtherCAT System Documentation

The comprehensive description in the [EtherCAT System Documentation](#) (EtherCAT Basics --> CoE Interface) must be observed!

A few brief extracts:

- Whether changes in the online directory are saved locally in the slave depends on the device. EL terminals (except the EL66xx) are able to save in this way.
- The user must manage the changes to the StartUp list.

Commissioning aid in the TwinCAT System Manager

Commissioning interfaces are being introduced as part of an ongoing process for EL/EP EtherCAT devices. These are available in TwinCAT System Managers from TwinCAT 2.11R2 and above. They are integrated into the System Manager through appropriately extended ESI configuration files.

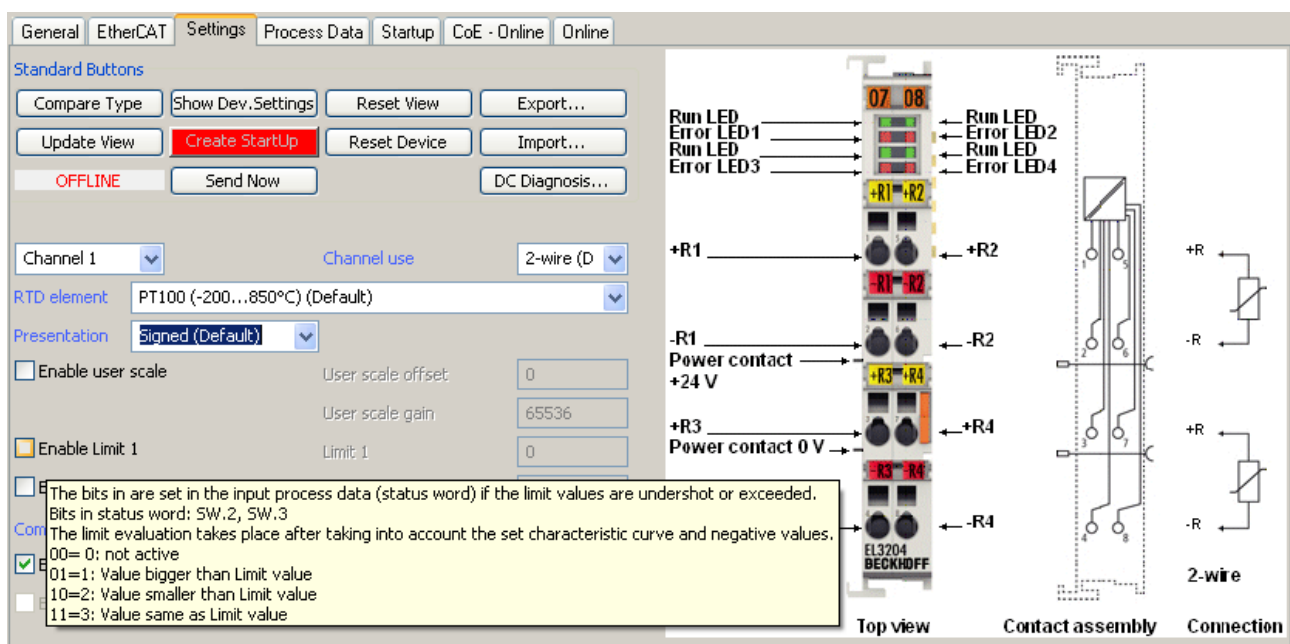

Fig. 183: Example of commissioning aid for a EL3204

This commissioning process simultaneously manages

- CoE Parameter Directory
- DC/FreeRun mode
- the available process data records (PDO)

Although the “Process Data”, “DC”, “Startup” and “CoE-Online” that used to be necessary for this are still displayed, it is recommended that, if the commissioning aid is used, the automatically generated settings are not changed by it.

The commissioning tool does not cover every possible application of an EL/EP device. If the available setting options are not adequate, the user can make the DC, PDO and CoE settings manually, as in the past.

EtherCAT State: automatic default behaviour of the TwinCAT System Manager and manual operation

After the operating power is switched on, an EtherCAT Slave must go through the following statuses

- INIT
- PREOP
- SAFEOP
- OP

to ensure sound operation. The EtherCAT Master directs these statuses in accordance with the initialization routines that are defined for commissioning the device by the ES/XML and user settings (Distributed Clocks (DC), PDO, CoE). See also the section on "Principles of [Communication, EtherCAT State Machine \[► 139\]](#)" in this connection. Depending how much configuration has to be done, and on the overall communication, booting can take up to a few seconds.

The EtherCAT Master itself must go through these routines when starting, until it has reached at least the OP target state.

The target state wanted by the user, and which is brought about automatically at start-up by TwinCAT, can be set in the System Manager. As soon as TwinCAT reaches the status RUN, the TwinCAT EtherCAT Master will approach the target states.

Standard setting

The advanced settings of the EtherCAT Master are set as standard:

- EtherCAT Master: OP
- Slaves: OP
This setting applies equally to all Slaves.

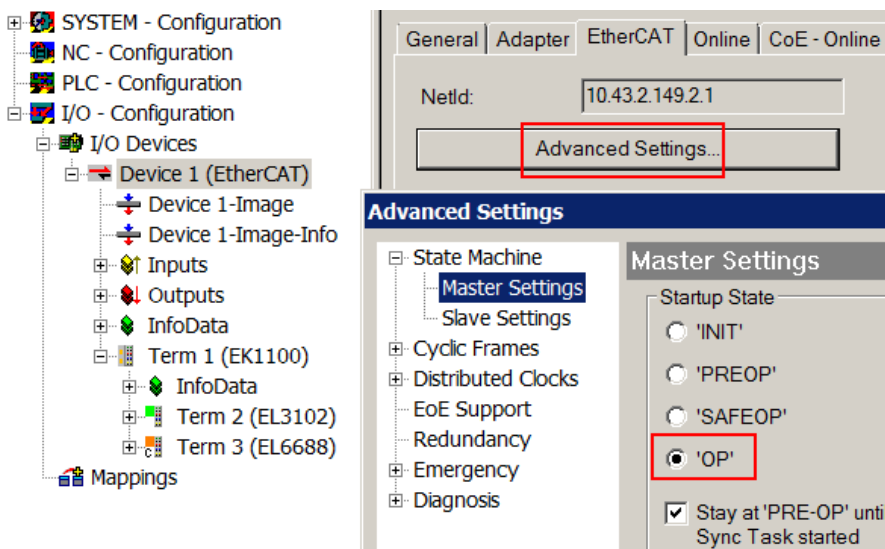

Fig. 184: Default behaviour of the System Manager

In addition, the target state of any particular Slave can be set in the “Advanced Settings” dialogue; the standard setting is again OP.

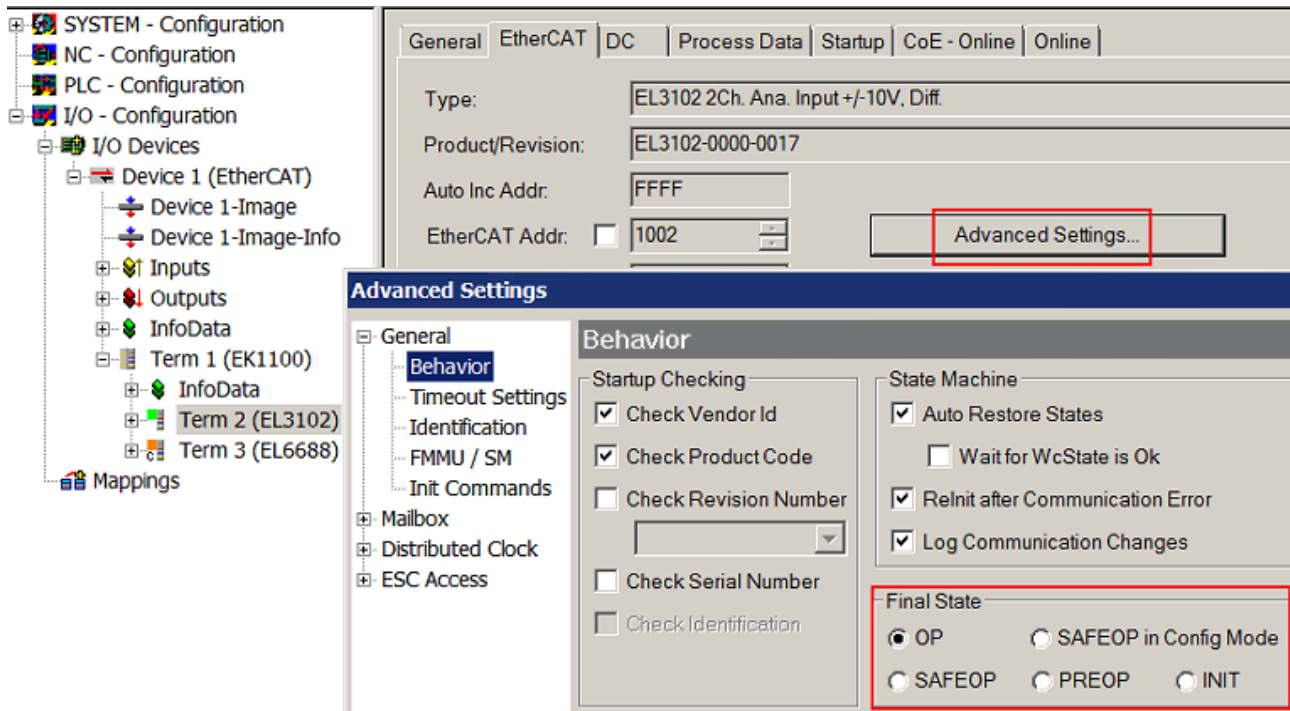

Fig. 185: Default target state in the Slave

Manual Control

There are particular reasons why it may be appropriate to control the states from the application/task/PLC. For instance:

- for diagnostic reasons
- to induce a controlled restart of axes
- because a change in the times involved in starting is desirable

In that case it is appropriate in the PLC application to use the PLC function blocks from the *TcEtherCAT.lib*, which is available as standard, and to work through the states in a controlled manner using, for instance, *FB_EcSetMasterState*.

It is then useful to put the settings in the EtherCAT Master to INIT for master and slave.

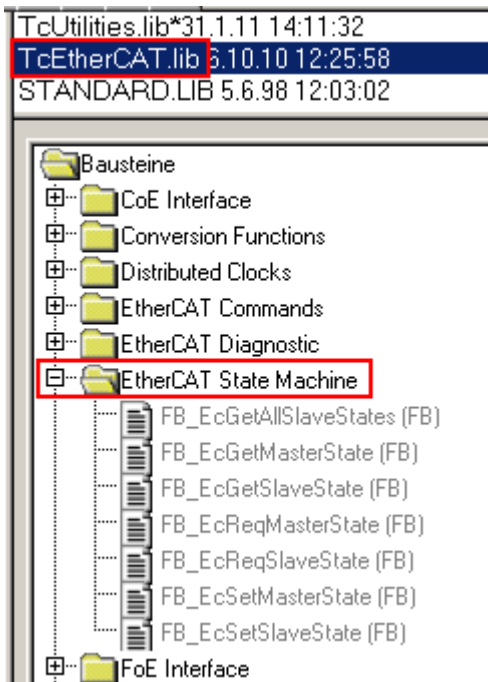

Fig. 186: PLC function blocks

Note regarding E-Bus current

EL/ES terminals are placed on the DIN rail at a coupler on the terminal strand. A Bus Coupler can supply the EL terminals added to it with the E-bus system voltage of 5 V; a coupler is thereby loadable up to 2 A as a rule. Information on how much current each EL terminal requires from the E-bus supply is available online and in the catalogue. If the added terminals require more current than the coupler can supply, then power feed terminals (e.g. EL9410) must be inserted at appropriate places in the terminal strand.

The pre-calculated theoretical maximum E-Bus current is displayed in the TwinCAT System Manager as a column value. A shortfall is marked by a negative total amount and an exclamation mark; a power feed terminal is to be placed before such a position.

General Adapter EtherCAT Online CoE - Online						
NetId:		10.43.2.149.2.1		Advanced Settings...		
Number	Box Name	Address	Type	In Size	Out S...	E-Bus (..
1	Term 1 (EK1100)	1001	EK1100			
2	Term 2 (EL3102)	1002	EL3102	8.0		1830
3	Term 4 (EL2004)	1003	EL2004		0.4	1730
4	Term 5 (EL2004)	1004	EL2004		0.4	1630
5	Term 6 (EL7031)	1005	EL7031	8.0	8.0	1510
6	Term 7 (EL2808)	1006	EL2808		1.0	1400
7	Term 8 (EL3602)	1007	EL3602	12.0		1210
8	Term 9 (EL3602)	1008	EL3602	12.0		1020
9	Term 10 (EL3602)	1009	EL3602	12.0		830
10	Term 11 (EL3602)	1010	EL3602	12.0		640
11	Term 12 (EL3602)	1011	EL3602	12.0		450
12	Term 13 (EL3602)	1012	EL3602	12.0		260
13	Term 14 (EL3602)	1013	EL3602	12.0		70
14	Term 3 (EL6688)	1014	EL6688	22.0		-240 !

Fig. 187: Illegally exceeding the E-Bus current

From TwinCAT 2.11 and above, a warning message “E-Bus Power of Terminal...” is output in the logger window when such a configuration is activated:



Fig. 188: Warning message for exceeding E-Bus current

<i>NOTICE</i>
<p>Caution! Malfunction possible!</p> <p>The same ground potential must be used for the E-Bus supply of all EtherCAT terminals in a terminal block!</p>

5.4 Process data and operation modes

5.4.1 Parameterization

An EL31xx is parameterized via 2 dialog boxes/tabs in the TwinCAT System Manager, the Process Data tab (A) for the communication-specific settings and the CoE directory (B) for the settings in the slave.

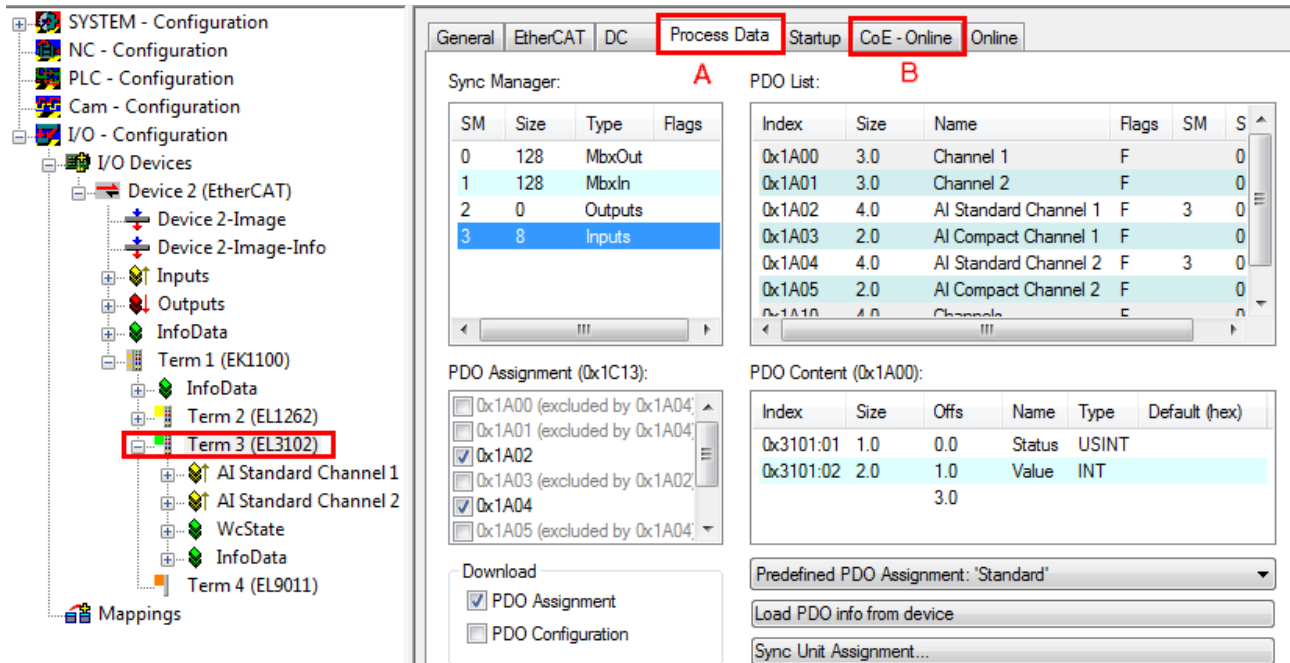

Fig. 189: EL31xx parameterization

- Changes to the process data-specific settings are generally only effective after a restart of the EtherCAT master:
Restart TwinCAT in RUN or CONFIG mode; RELOAD in CONFIG mode
- Changes to the online CoE directory
 - are in general immediately effective
 - are in general stored non-volatile *only* in the terminal/in the slave and should therefore be entered in the CoE StartUp list. This list is processed at each EtherCAT start and the settings are loaded into the slave.

5.4.2 Settings and operating modes

5.4.2.1 Presentation, index 0x80n0:02

The measured value output is set in factory to two's complement representation (signed integer). Index [0x80n0:02](#) [► 297] offers the possibility to change the method of representation of the measured value.

Signed integer representation

The negative output value is represented in two's complement (negated + 1).
Maximum representation range for 16 bits = -32768_{dec} to $+32767_{dec}$

Input signal					Value	
EL310x	EL311x, EL314x	EL3112-0011	EL312x, EL315x	EL316x	Decimal	Hexadecimal
10 V	20 mA	20 mA	20 mA	10 V	32767	0x7FFF
5 V	10 mA	10 mA	12 mA	5 V	16383	0x3FFF
0 V	0 mA	0 mA	4 mA	0 V	0	0x0000
-5 V	-	-10 mA	-	-	-16383	0xC001
-10 V	-	-20 mA	-	-	-32768	0x8000

Input signal EL3174, EL3174-0002, EL3174-0090						Value	
±10 V	0..10 V	±20 mA	0..20 mA	4..20 mA	4..20 mA (NAMUR)	Decimal	Hexadecimal
10,737 V	10,737 V	21, 474 mA	21,474 mA	21,179 mA	-	32767	0x7FFF
10 V	10 V	20 mA	20 mA	20 mA	20 mA	30518	0x7736
0 V	0 V	0 mA	0 mA	4 mA	4 mA	0	0x0000
-	-	-	-	0 mA	-	-7629	0xE233
-10 V	-	-20 mA	-	-	-	-30518	0x88CA
-10,737 V	-	-21, 474 mA	-	-	-	-32768	0x8000

Input signal EL3174-0032						Value	
±3 V	0..3 V	±20 mA	0..20 mA	4..20 mA	4..20 mA (NAMUR)	Decimal	Hexadecimal
3,221 V	3, 221 V	21, 474 mA	21,474 mA	21,179 mA	-	32767	0x7FFF
3 V	3 V	20 mA	20 mA	20 mA	20 mA	30518	0x7736
0 V	0 V	0 mA	0 mA	4 mA	4 mA	0	0x0000
-	-	-	-	0 mA	-	-7629	0xE233
-3 V	-	-20 mA	-	-	-	-30518	0x88CA
-3, 221 V	-	-21, 474 mA	-	-	-	-32768	0x8000

Input signal EL3174-0042		Value	
±60 V	±30 V	Decimal	Hexadecimal
64.41 V	32.21 V	32767	0x7FFF
60 V	30 V	30518	0x7736
0 V	0 V	0	0x0000
-	-	-7629	0xE233
-60 V	-30 V	-30518	0x88CA
--64.41 V	-32.21 V	-32768	0x8000

Overview of further representations

Unsigned integer representation

The output value is represented with 15-bit resolution without sign, therefore polarity detection is no longer possible.

Maximum representation range for 16 bits = 0 to +32767_{dec}

Absolute value with MSB as sign - representation

The output value is displayed in magnitude-sign format: MSB=1 (highest bit) in the case of negative values.

Maximum representation range for 16 bits = -32767_{dec} to +32767_{dec}

Legacy Range	Extended Range	Representation (values dec. / values hex.)			
		unsigned interger		abs. value w. MSB as sign	
		Dec.	Hex.	Dec.	Hex.
100%	107,37%	32767	0x7FFF	32767	0x7FFF
-	100%	30518	0x7736	30518	0x7736
0%	0%	0	0x0000	0	0x0000
-	-100%	30518	0x7736	[-30518]	0xF736
-100%	-107,37%	32767	0x7FFF	[-32767]	0xFFFF

● Presentation types



The presentation types "Unsigned integer" and "Absolute value with MSB as sign" have no function for unipolar terminals. There is no change in the presentation in the positive range.

5.4.2.2 Siemens bits, index 0x80n0:05

Siemens bits, index 0x80n0:05 [[▶ 297](#)]

If this bit is set, status displays are superimposed on the lowest three bits. In the error case "overrange" or "underrange", bit 0 is set.

5.4.2.3 Undershoot and overshoot of the measuring range (under-range, over-range), index 0x60n0:01, 0x60n0:02

Undershoot and overshoot of the measuring range (under-range, over-range), index 0x60n0:01 [[▶ 298](#)], 0x60n0:02 [[▶ 298](#)]

Chapter [Data stream and correction calculation](#) [[▶ 262](#)] contains a clear description of the correction calculation between the raw values and the output values if the limit ranges are exceeded.

5.4.2.4 Limit 1 and limit 2, Swap Limit Bits

Limit 1 and limit 2, index 0x80n0:13, [[▶ 297](#)] index 0x80n0:14 [[▶ 297](#)]

If the value exceeds or falls below these values, which can be entered in the indices 0x80n0:13 [[▶ 297](#)] and 0x80n0:14 [[▶ 297](#)], then the bits in the indices 0x60n0:03 [[▶ 298](#)] and 0x60n0:05 [[▶ 298](#)] are set accordingly (see example below). The indices 0x80n0:07 [[▶ 297](#)] or 0x80n0:08 [[▶ 297](#)] serve to activate the limit value monitoring.

Output limit n (2-bit):

- 0: not active
- 1: Value is smaller than the limit value
- 2: Value is larger than the limit value
- 3: Value is equal to the limit value

● Limit evaluation



The limit evaluation assumes a signed representation. The conversion to the desired representation (index 0x80n0:02 [[▶ 297](#)]) only takes place after the limit evaluation.

● Linking in the PLC with 2-bit values



The limit information consists of 2 bits. Limitn can be linked to the PLC or a task in the System Manager.

- PLC:
IEC61131-PLC contains no 2-bit data type that can be linked with this process data directly. For transferring the limit information, define an input byte (e.g. see Fig. *Input byte definition*) and link the limit to the *VariableSizeMismatch* dialog, as described in section Note about the 1-byte status of earlier EtherCAT Terminals [▶ 257].

```
VAR
  byLimit1 AT %I*:BYTE;
END_VAR
```

Fig. 190: Input byte definition

- Additional task
2-bit variables can be created in the System Manager.

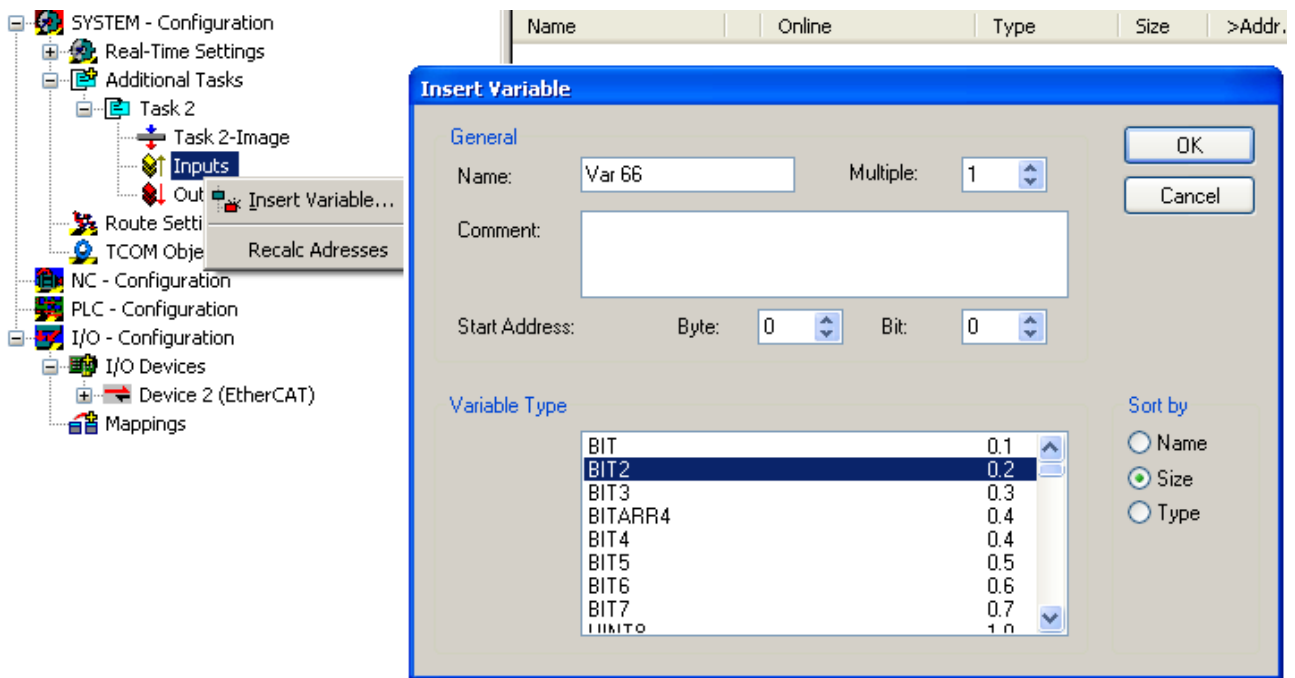

Fig. 191: Linking of 2-bit variable to additional task

Example for EL3162:

Channel 1; Limit 1 and Limit 2 enabled, Limit 1 = 2.8 V, Limit 2 = 7.4 V, representation: signed integer

Entry in index (Limit 1): 0x8000:13 [▶ 297]
 $(2.8 \text{ V} / 10 \text{ V}) \times 2^{16} / 2 - 1 = 9.174_{\text{dec}}$

Entry in index (Limit 2): 0x8000:14 [▶ 297]
 $(7.4 \text{ V} / 10 \text{ V}) \times 2^{16} / 2 - 1 = 24.247_{\text{dec}}$

Output:

Input channel 1	Index <u>0x6000:03</u> [▶ 298]	Index <u>0x6000:05</u> [▶ 298]
1.8 V	0x01 _{hex} , (Limit 1, limit value undershot)	0x01 _{hex} , (Limit 2, limit value undershot)
2.8 V	0x03 _{hex} , (Limit 1, limit value reached)	0x01 _{hex} , (Limit 2, limit value undershot)
4.2 V	0x02 _{hex} , (Limit 1, limit value exceeded)	0x01 _{hex} , (Limit 2, limit value undershot)
8.5 V	0x02 _{hex} , (Limit 1, limit value exceeded)	0x02 _{hex} , (Limit 2, limit value exceeded)

Swap Limit index 0x80n0:0E [▶ 297]

The limit function can be inverted by *SwapLimitBits* in index 0x80n0:0E.

Output Limit n (2-bit):

SwapLimitBits setting	Value
FALSE (default setting)	<ul style="list-style-type: none"> • 0: not active • 1: value < limit value • 2: value > limit value • 3: Value is equal to the limit value
TRUE	<ul style="list-style-type: none"> • 0: not active • 1: value > limit value • 2: value < limit value • 3: Value is equal to the limit value

The Swap limit function is available according to the table below

Terminal	Swap limit function from
EL31x1, EL31x4	All firmware versions
EL3112-0011	All firmware versions
EL3102	Firmware 08
EL3112	Firmware 08
EL3122	Firmware 08
EL3142	Firmware 08
EL3152	Firmware 09
EL3162	Firmware 08
EL3174, EL3174-00xx	All firmware versions

5.4.2.5 Operating modes

The EL30xx and the EL31xx accordingly supports three different operating modes: Freerun (filter on, timer interrupt), Synchron (filter off, SyncManager interrupt) and DC (DC Sync interrupt)

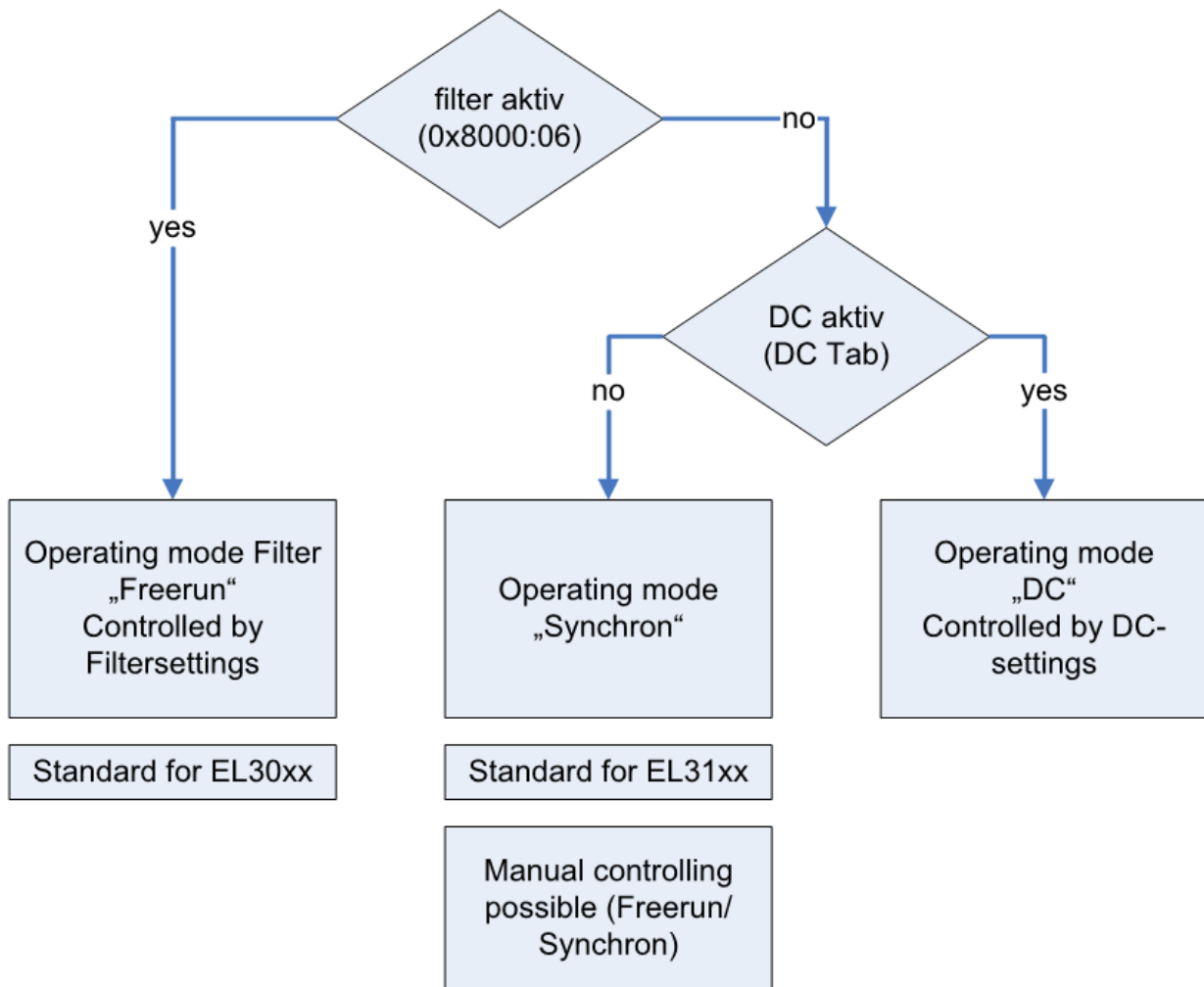

Fig. 192: Relationship of operating modes

The terminal switches between the Freerun (filter on) and Synchron modes by activating/deactivating the filter via the index. The terminal remains in OP mode during this process. The changeover may result in longer sampling times and step changes in the process data until the filters have assumed a steady state.

DC mode can only be used when the filters are switched off. Likewise, it is not possible to switch the filters on in DC mode. The DC mode is parameterized via the DC tab in the TwinCAT System Manager.

The operating modes of the EL30xx/EL31xx are:

Mode	1 (default)	2	3	4	5	6
Filter (Index: 0x8000:06)	On (default.: 50 Hz FIR)	Off				
Distributed Clocks mode	Off					On
Possible with EL30xx	x	x	x	x	x	
Possible with EL31xx	x	x	x	x	x	x
Default setting for	EL30xx			EL31xx		
Synchronization mode (index:0x1C33:01, bit 0+1)	0: FreeRun (default)	0: FreeRun (default)		1: Frame triggered (SM3 inputs)		3: DC mode
FastOp-Mode "CoE" (Index: 0x1C33:01, bit 15)	Off (default)	Off (default)	On	Off (default)	On	Off (default) (FastOP mode n.a. in DC mode)
StartUp entry index 0x1C33:01	0x0000	0x0000	0x8000	0x0001	0x8001	
Update frequency	depends on filter setting; automatically set inside the terminal see following values			EtherCAT cycle time, if value does not fall below the lower setting-dependent limit. See following values for typical limit. Operation with a faster EtherCAT cycle is possible, but in that case the EL30xx no longer supplies new data in each cycle.		EtherCAT cycle time, if value does not fall below the lower setting-dependent limit.
typical data update time (EL30x1)	50 Hz FIR: typical 625 μ s	< 600 μ s	< 500 μ s			
typ. data update time (EL30x2)	60 Hz FIR: typical 520 μ s					
typ. data update time (EL30x4)	IIR: typical 1 ms					
typ. data update time (EL30x8)	50 Hz FIR: typ. 1.25 ms 60 Hz FIR: typ. 1 ms IIR: typ. 1 ms	< 1.1 ms	< 1 ms			
Note	If filtering is enabled, the following settings are activated in the EL30xx, irrespective of other settings "FreeRun" = on and "FastOp mode" = off.					The notes on the minimum EtherCAT cycle time in DC mode must be observed.

i Combinations of filters, FastOp mode and Synchronization mode

Other combination options of filter, FastOp mode and Synchronization mode are expressly not recommended.

Synchron mode

In synchronous operation process data are generated frame-triggered, so that a new value is available with each PLC cycle. In the EL31xx terminals synchron mode is used automatically (filter off, no DC). The minimum cycle times are 80 μ s (EL31x1/EL31x2), and 120 μ s (EL31x4) for standard IPCs.

DC operation

In DC mode the process data are requested via DC interrupt. This results in the temporal jitter between two frames being equalized, so that the sampling time is uniform across the system.

The EL31xx should be operated in DC input based mode.

The DC mode requires minimum cycle times of

- 100 µs (EL31x1/EL31x2 in 1 channel mode)
- 125 µs (EL31x2 in 2 channel mode)
- 150 µs (EL31x4)
- 250 µs (EL3174)
- 200 µs (EL3174-0002, EL3174-0032)
- 500 µs (EL3174-0090)

for standard IPCs.

In input-based mode the sync interrupt is shifted automatically, so that the process data are ready just before the current process data cycle.

If the frame jitter is too large, there is still the possibility that duplicate data will be retrieved or that the transmission will be interrupted. Then the jitter must be reduced or a slower cycle time selected by TwinCAT system corrective measures.

5.4.2.6 Filter operation (FIR and IIR), index 0x80n0:06, 0x80n0:15

Filter operation (FIR and IIR), index [0x80n0:06 \[▶ 297\]](#), [0x80n0:15 \[▶ 297\]](#)

The EL 31xx terminals incorporate a digital filter which, depending on its settings, can adopt the characteristics of a *Finite Impulse Response* filter (an *FIR filter*), or an *Infinite Impulse Response* filter (an *IIR filter*). The filter is deactivated by default. Please observe the following note regarding activation with index [0x8000:06 \[▶ 297\]](#).

i ● **Activation of the filter with index [0x8000:06 \[▶ 297\]](#) and setting of the filter characteristics via index [0x8000:15 \[▶ 297\]](#)**

The filter frequencies are set for all channels of the EL3xxx terminals centrally via index [0x8000:15 \[▶ 297\]](#) (channel 1). The corresponding indices 0x80n0:15 of the other channels have no parameterization function.

FIR filter

Parameterized via the index [0x8000:15 \[▶ 297\]](#).

The filter performs a notch filter function and determines the conversion time of the terminal. The higher the filter frequency, the faster the conversion time. A 50 Hz and a 60 Hz filter are available.

Notch filter means that the filter has zeros (notches) in the frequency response at the filter frequency and multiples thereof, i.e. it attenuates the amplitude at these frequencies.

The FIR filter operates as a non-recursive filter.

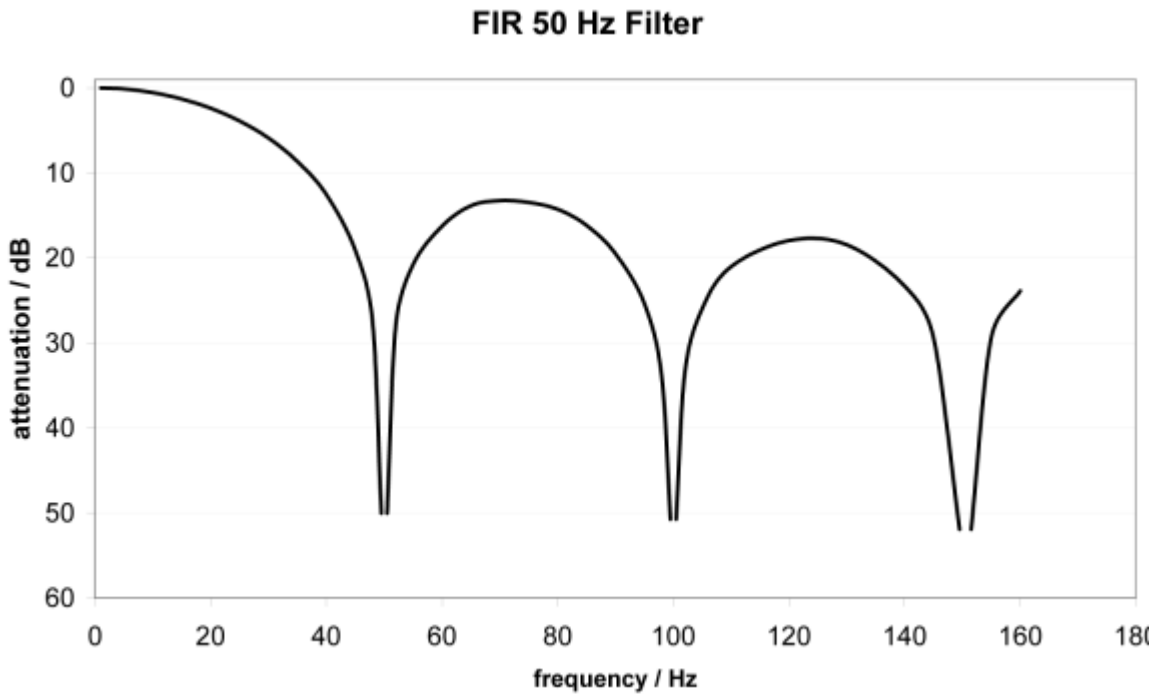

Fig. 193: Attenuation curve notch.filter at 50 Hz

Filter data for FIR filter (1 to 4-channel terminals)			
Filter	Attenuation	Limit frequency (-3 dB)	Conversion time
50 Hz FIR	> 50 dB	22 Hz	625 μ s
60 Hz FIR	> 45 dB	26 Hz	521 μ s

IIR filter

The filter with IIR characteristic is a time-discrete, linear, time-invariant low-pass filter of 1st order (-20dB/decade), which can be adjusted in 8 levels, i.e. cut-off frequencies. (level 1 = weak recursive filter, up to level 8 = strong recursive filter).

The IIR can be understood to be a moving average value calculation after a low-pass filter.

Through the synchronization mode *FreeRun* the IIR filter operates with an internal cycle time of 180 μ s (1 or 2 channels) or 500 μ s (4 channels).

IIR filter	EL31x1, EL31x2, sampling time 180 μ s	EL31x4, sampling time 500 μ s
	Limit frequency (-3 dB)	Limit frequency (-3 dB)
IIR 1	1 kHz	400 Hz
IIR 2	500 Hz	220 Hz
IIR 3	285 Hz	100 Hz
IIR 4	142 Hz	50 Hz
IIR 5	66 Hz	24 Hz
IIR 6	33 Hz	12 Hz
IIR 7	17 Hz	6.2 Hz
IIR 8	8.2 Hz	3.0 Hz

5.4.3 Process data

Table of contents
• Interpretation of value & status variable [▶ 253]
• Status word [▶ 254]
• Changeover of process data sets [▶ 255]
• Note about TwinCAT 2.10 [▶ 258]
• Password protection for user calibration [▶ 259]

The EL31xx terminals offer two different process data per analog channel for transmission: the analog value *Value* (16 bit) and status information (16 bit). As with individual channels, the transmission of individual status information can be deactivated in the *ProcessData* tab; these changes are effective after activation and an EtherCAT restart or reload.

There is a choice of two types of process data in the EL31xx:

- Standard: standard setting, *Value* (16 bit) and status information (8 or 16 bit) are transmitted per channel
- Compact: only the *Value* (16 bit) is transmitted per channel

The settings are described below, taking the EL3102 (two channels, ±10 V) as an example. The data apply to TwinCAT 2.11 from build 1544 onward and XML revision from EL31xx-0000-0016 onward.

Interpretation of value and status variable

Name	Online	Type	Size	> Addr...	In/Out	User ID
↕ Status	0x0000 (0)	Status_4096	2.0	83.0	Input	0
↕ Value	0xFFFC <-0.001>	INT	2.0	85.0	Input	0
↕ Status	0x0000 (0)	Status_4096	2.0	87.0	Input	0
↕ Value	0xFFFC <-0.001>	INT	2.0	89.0	Input	0
↕ WcState	0	BOOL	0.1	1522.3	Input	0
↕ State	0x0008 (8)	UINT	2.0	1560.0	Input	0
↕ AdsAddr	AC 10 03 A2 03 01 ...	AMSADDR...	8.0	1562.0	Input	0

Fig. 194: Default process data of the EL3102-0000-0016

The plain text display of the bit meanings of the status word is particularly helpful not only in commissioning but also for linking to the PLC program.

By right-clicking on the status variable in the configuration tree (A), the structure can be opened for linking (B).

In order to be able to read the bit meanings in plain text in the online display (C), the button

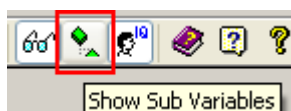

Fig. 195: Show sub variables

can be used to show all subvariables, including the structure content of the status word, see Fig. *Display subvariables of the EL3102-0000-0016 from TwinCAT 2.11 build 1544*

Name	Online	Type	Size	>Addr...
↑ Status	0x8000 (32768)	Status_4096	2.0	83.0
↑ Underrange	0	BOOL	0.1	83.0
↑ Overrange	0	BOOL	0.1	83.1
↑ Limit 1	0x0 (0)	BIT2	0.2	83.2
↑ Limit 2	0x0 (0)	BIT2	0.2	83.4
↑ Error	0	BOOL	0.1	83.6
↑ Sync error	0	BOOL	0.1	84.5
↑ TxPDO State	0	BOOL	0.1	84.6
↑ TxPDO Toggle	1	BOOL	0.1	84.7
↑ Value	0x0001 <0.000>	INT	2.0	85.0
↑ Status	0x8000 (32768)	Status_4096	2.0	87.0
↑ Underrange	0	BOOL	0.1	87.0
↑ Overrange	0	BOOL	0.1	87.1
↑ Limit 1	0x0 (0)	BIT2	0.2	87.2
↑ Limit 2	0x0 (0)	BIT2	0.2	87.4
↑ Error	0	BOOL	0.1	87.6
↑ Sync error	0	BOOL	0.1	88.5
↑ TxPDO State	0	BOOL	0.1	88.6
↑ TxPDO Toggle	1	BOOL	0.1	88.7
↑ Value	0xFFFFD <-0.001>	INT	2.0	89.0
↑ WcState	0	BOOL	0.1	1522.3
↑ State	0x0008 (8)	UINT	2.0	1560.0
↑ AdsAddr	AC 10 03 A2 03 01 ...	AMSADDR...	8.0	1562.0
↑ netId	AC 10 03 A2 03 01	ARRAY [0.....	6.0	1562.0
↑ netId[0]	0xAC (172)	USINT	1.0	1562.0
↑ netId[1]	0x10 (16)	USINT	1.0	1563.0
↑ netId[2]	0x03 (3)	USINT	1.0	1564.0
↑ netId[3]	0xA2 (162)	USINT	1.0	1565.0
↑ netId[4]	0x03 (3)	USINT	1.0	1566.0
↑ netId[5]	0x01 (1)	USINT	1.0	1567.0
↑ port	0x03EB (1003)	UINT	2.0	1568.0

Fig. 196: Display of the subvariables of the EL3102-0000-0016 from TwinCAT 2.11 build 1544 onwards

Control/status word

Status word

The status word (SW) is located in the input process image, and is transmitted from terminal to the controller.

Bit	SW.15	SW.14	SW.13	SW.12	SW.11	SW.10	SW.9	SW.8
Name	TxPDO Toggle	TxPDO State	Sync error	-	-	-	-	-

Bit	SW.7	SW.6	SW.5	SW.4	SW.3	SW.2	SW.1	SW.0
Name	-	ERROR	Limit 2		Limit 1		Overrange	Underrange

Legend

Bit	Name	Description	
SW.15	TxPDO Toggle	1 _{bin}	Toggles with each new analog process value
SW.14	TxPDO State	1 _{bin}	TRUE in the case of an internal error
SW.13*	Sync error	1 _{bin}	TRUE (DC mode): a synchronization error occurred in the expired cycle.
SW.6	ERROR	1 _{bin}	General error bit, is set together with overrange and underrange
SW.5	Limit 2	1 _{bin}	See Limit [▶ 246]
SW.4		1 _{bin}	
SW.3	Limit 1	1 _{bin}	See Limit [▶ 246]
SW.2		1 _{bin}	
SW.1	Overrange	1 _{bin}	Analog input signal lies above the upper permissible threshold for this terminal
SW.0	Underrange	1 _{bin}	Analog input signal lies under the lower permissible threshold for this terminal

*) from rev. EL31xx-0000-0016

Control word

The EL31xx have no control word

Changeover of process data sets

The process data to be transmitted (PDO, ProcessDataObjects) can be selected by the user

- completely for all channels via the selection dialog “Predefined PDO Assignment” (all TwinCAT versions)
- selective for individual PDOs, taking into account the excluded elements.

“Predefined PDO Assignment” selection dialog (from TwinCAT 2.11 build 1544 onwards)

Defined PDO sets can be preselected if they exist in the XML description.

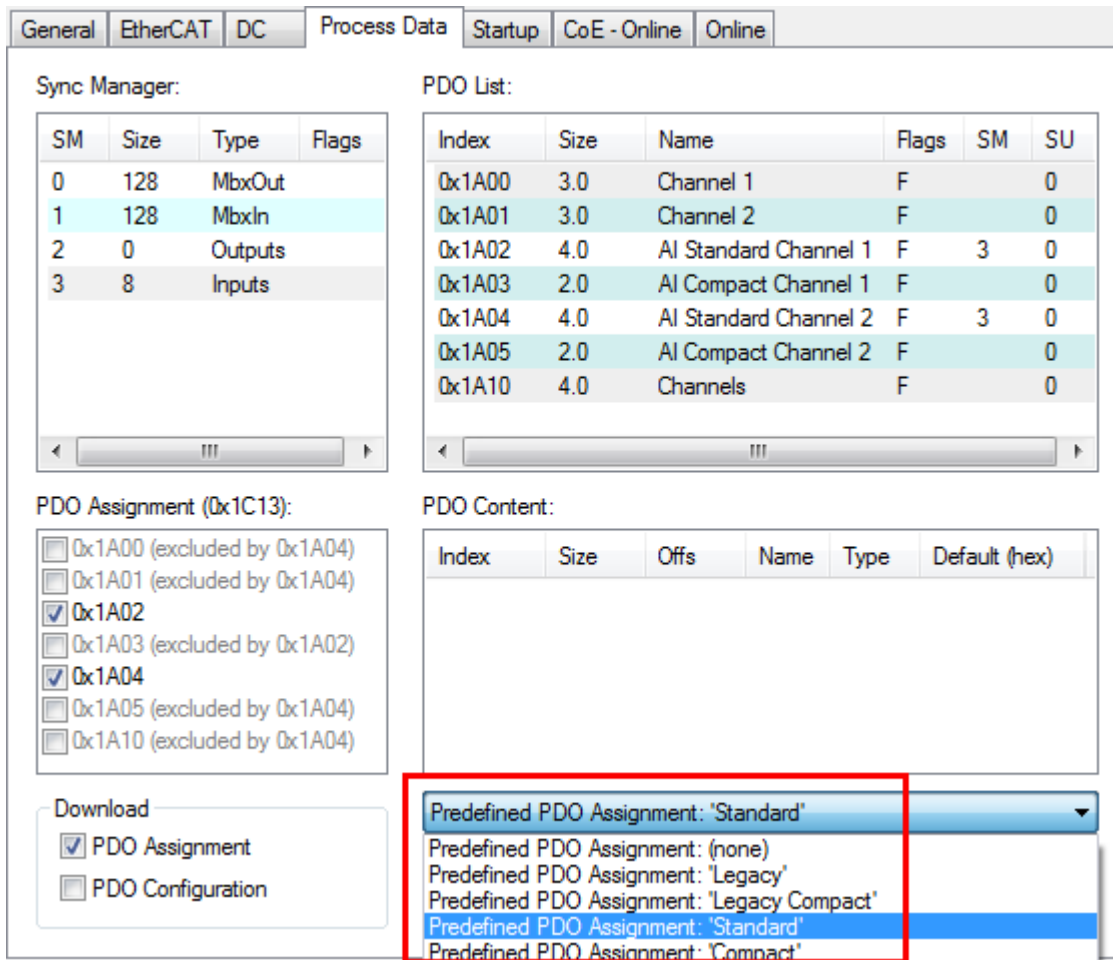

Fig. 197: Predefined PDO assignment in the EL3102-0000-0016

All channels of the EL31x2 are simultaneously set to legacy, legacy compact, standard or compact process image.

Selective PDO selection

All TwinCAT versions support the selective selection of individual PDOs, as defined in the XML description. Exclusion criteria prevent irregular combinations.

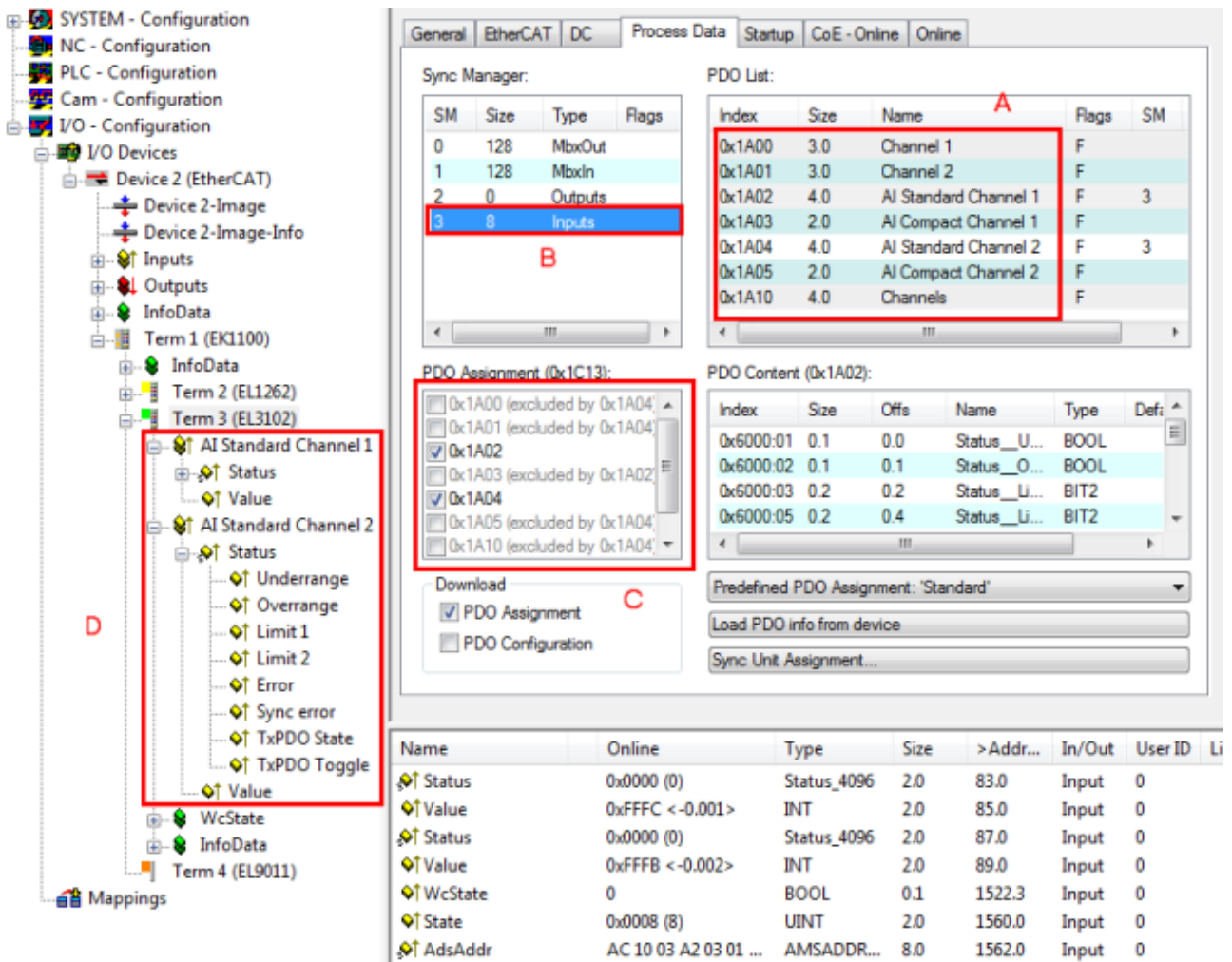

Fig. 198: Selective PDO selection

Explanatory notes regarding *Selective PDO selection*: In the "Process Data" tab, it can be seen under (A) that this EL3102 offers several different PDOs for the transmission, and in fact for each channel

- "Legacy" from CoE index 0x1A00/0x1A01: status word and measured value for channel, 3 bytes
- "Legacy compact" from CoE index 0x1A10: only measured value for 2 channels, 4 bytes
- "AI standard" from CoE index 0x1A02/0x1A04: measured value for channel and status, 4 bytes
- "AI Compact" under CoE index 0x1A03/0x1A05: only measured value for channel, 2 bytes

Legacy PDO Assignment

I The legacy PDO Assignment is a compatibility mode for previous 2-channel 16-bit input terminals (EL31x2) and should not be used for new configurations. This mode ensures complication-free replacement of older EL31x2 models with new ones. See also the following chapter.

By selecting the necessary Input SyncManager in (B), the PDO assignment under (C) can be carried out manually. The process data can then be linked in the TwinCAT tree (D).

Note about the 1-byte status of earlier EtherCAT terminals

Previous analog input terminals from Beckhoff (e.g. EL31x2) had a status byte instead of the status word that is now implemented and therefore a 3-byte interface. 8 additional bits now offer extended diagnostic options, wherein the default process image of the EL31xx now encompasses 4 bytes, status word and value word. The bit meanings of the LowByte are retained; Limit1 and Limit2 as 2-bit types are shown in the case of the EL31xx.

Name	Online	Type	Size
Status	0x00 (0)	BYTE	1.0
Value	0x0000 <0.000>	INT	2.0
Status	0x00 (0)	BYTE	1.0
Value	0x0000 <0.000>	INT	2.0
WcState	1	BOOL	0.1
State	0x0101 (257)	UINT	2.0
AdsAddr	AC 10 09 A2 03 01 ...	AMSADDRESS	8.0

Fig. 199: 3-byte interface of the EL31x2

If the 3-byte interface for linking to the analogue input channel is implemented in existing PLC projects, the TwinCAT System Manager nevertheless offers the possibility to link the EL31xx with a 4-byte interface.

To do this, open the link dialog as usual by double-clicking on the variable and activate the *AllTypes* checkbox. As a result, variables with differing sizes are also offered for linking. Select the corresponding 1-byte input variable for your application. The 8 bit coverage is confirmed in the following *SizeMismatch* dialog, Fig. *Element-orientated process image under TwinCAT 2.10*.

The screenshot shows the TwinCAT 2.10 interface with the following elements:

- PLC - Configuration:** A tree view showing the project structure, including 'Term 3 (EL3102-0000-0017)' with 'AI Standard Channel 1' and 'AI Standard Channel 2'. A red arrow points from 'byStatus' (type: byte) to 'Status' (type: word) in the 'AI Standard Channel 1'.
- Attach Variable Status (Input) Dialog:** Shows the selection of 'byStatus' (IB 0.0, BYTE [1.0]) from the 'MAIN.stAnalogIn_1_StatusByte' variable.
- Variable Size Mismatch Dialog:** Shows the linked variable 'byStatus' with a size of 8 bits, and the 'All Types' checkbox checked.

Fig. 200: Connecting the 4-byte interface of the EL31xx to a 3-byte interface existing in the project

Note about TwinCAT 2.10

The structured representation of EL31xx from revision EL31xx-0000-0016, as shown in Fig. *Selective PDO selection* is due to a corresponding interpretation of the variable names. This function does not exist in TwinCAT 2.10 yet, which is why only element-wise linking is possible there.

Name	Type	Size
Status__Underrange	BOOL	0.1
Status__Overrange	BOOL	0.1
Status__Limit 1	BIT2	0.2
Status__Limit 2	BIT2	0.2
Status__Error	BOOL	0.1
Status__Sync error	BOOL	0.1
Status__TxPDO State	BOOL	0.1
Status__TxPDO Tog...	BOOL	0.1
Value	INT	2.0
Status__Underrange	BOOL	0.1
Status__Overrange	BOOL	0.1
Status__Limit 1	BIT2	0.2
Status__Limit 2	BIT2	0.2
Status__Error	BOOL	0.1
Status__Sync error	BOOL	0.1
Status__TxPDO State	BOOL	0.1
Status__TxPDO Tog...	BOOL	0.1
Value	INT	2.0
WcState	BOOL	0.1
State	UINT	2.0
AdsAddr	AMSADDRESS	8.0

Fig. 201: Element-orientated process image under TwinCAT 2.10

Password protection for user data

Several user data is protected for unrequested or mistaken write access by a password to be entered within CoE 0xF009:

- CoE write access by the user, PLC or start up entries in *Single-* or *CompleteAccess* access
- Overwriting the values by *RestoreDefaultParameter* access to 0x80n0 (and accordingly 0x80nD, if present)

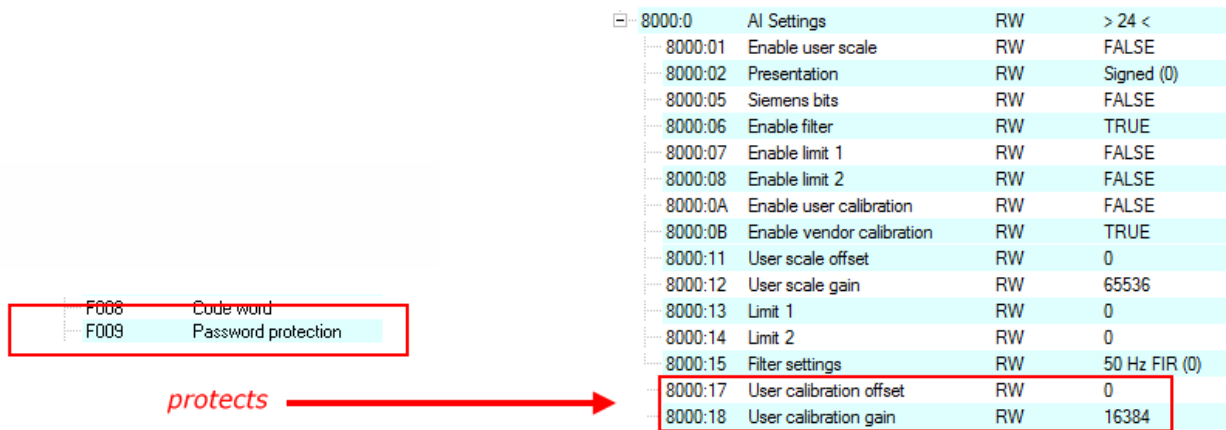

Fig. 202: Password protection for the 0x8000:17 and 0x8000:18 entries (example)

The password protection is provided for following user data

Protect-able CoE object	Terminals
0x80n0:17 (User Calibration Offset)	EL31xx,
0x80n0:18 (User Calibration Gain)	ELX31xx
0x80nD:17, (Low Range Error)	EL3172, EL3174, EL3174-00xx,
0x80nD:18 (High Range Error)	EL318x, ELX3181

Application of CoE 0xF009

- Insertion of 0x12345678 activates the password protection → object indicates '1' (switched on)
Protected objects can no longer be changed; there is no error message by a write access!

- Insertion of 0x11223344 deactivates the password protection → object indicates '0' (switched off)



Code word index 0xF008

This CoE object has simply a vendor specific task and is not dedicated for the user.

This function is available according to the table below

Terminal	from FW
EL31x1	FW02
EL3104	FW04
EL3114	FW07
EL3124	FW05
EL3144	FW05
EL3154	FW05
EL3164	FW04
EL3172	FW01
EL3174	FW03
EL3174-0002, EL3174-0032	FW02
EL3174-0042	FW01
EL3174-0090	FW04

5.4.4 Data stream and measurement ranges

Table of contents
• Data stream [▶ 261]
• Correction calculation [▶ 262]
• Calibration [▶ 269]
• Manufacturer compensation [▶ 269]
• User compensation [▶ 269]
• User scaling [▶ 269]

Data stream

The flow chart at the bottom (Fig. *Data stream representation of the EL31xx*) illustrates the data stream in the EL31xx (processing of the raw data).

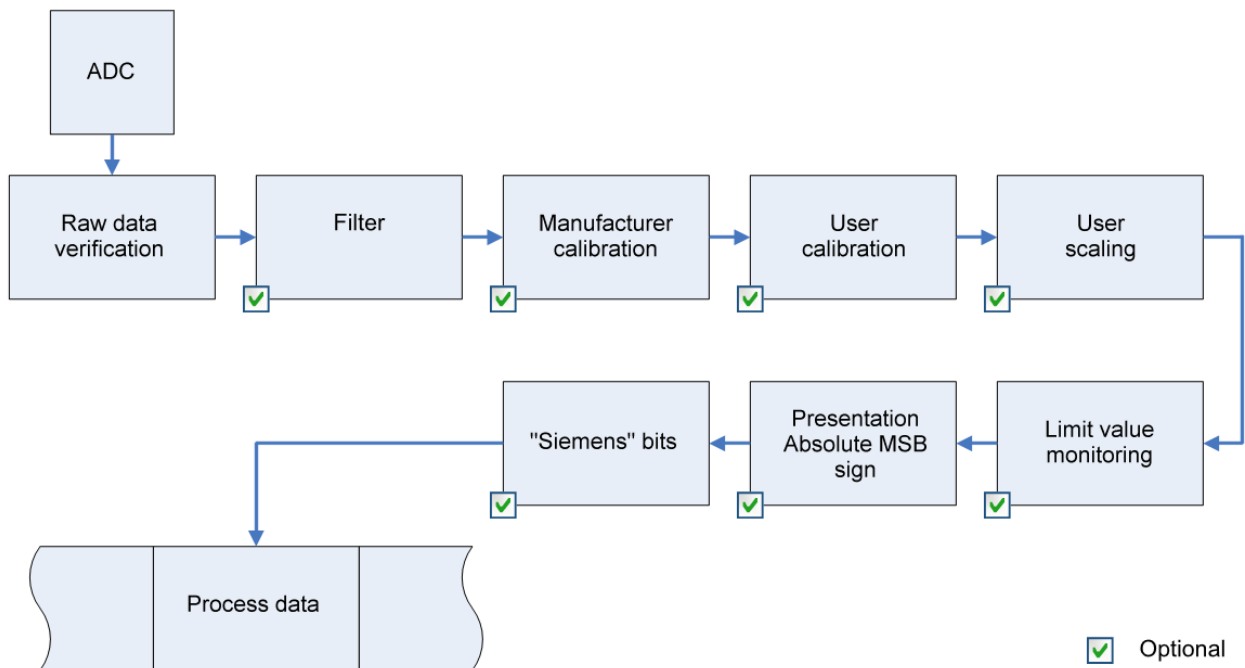

Fig. 203: *Data stream representation of the EL31xx*

Calculation of process data

The concept “calibration”, which has historical roots at Beckhoff, is used here even if it has nothing to do with the deviation statements of a calibration certificate. Actually, this is a description of the vendor or customer calibration data/adjustment data used by the device during operation in order to maintain the assured measuring accuracy.

The terminal constantly records measured values and saves the raw values from its A/D converter in the ADC raw value object `0x80nE:01` [▶ 299]. After each recording of the analog signal, the correction calculation takes place with the vendor and user calibration data as well as the user scaling, if these are activated (see fig. *Data stream representation of the EL31xx* [▶ 261]).

Calculation	Designation
$X_F = f(X_{ADC})$	Output value after the filter
$Y_H = (X_{ADC} - B_H) \times A_H \times 2^{-14}$	Measured value after vendor calibration,
$Y_A = (Y_H - B_A) \times A_A \times 2^{-14}$	Measured value after vendor and user calibration
$Y_S = Y_A \times A_S \times 2^{-16} + B_S$	Measured value following user scaling

Name	Designation	Index
X _{ADC}	Output value of the A/D converter	0x80nE:01 [▶ 299]
X _F	Output value after the filter	-
B _H	Vendor calibration offset (not changeable)	0x80nF:01 [▶ 298]
A _H	Vendor calibration gain (not changeable)	0x80nF:02 [▶ 298]
B _A	User calibration offset (can be activated via index 0x80n0:0A [▶ 297])	0x80n0:17 [▶ 297]
A _A	User calibration gain (can be activated via index 0x80n0:0A [▶ 297])	0x80n0:18 [▶ 297]
B _S	User scaling offset (can be activated via index 0x80n0:01 [▶ 297])	0x80n0:11 [▶ 297]
A _S	User scaling gain (can be activated via index 0x80n0:01 [▶ 297])	0x80n0:12 [▶ 297]
Y _S	Process data for controller	-

Measurement result

The accuracy of the result may be reduced if the measured value is smaller than 32767 / 4 due to one or more multiplications.

Measurement ranges

The diagrams at the bottom show the output values of the measurement ranges and the behavior if the limit ranges are exceeded.

EL310x, EL3112-0011, EL3142-0010

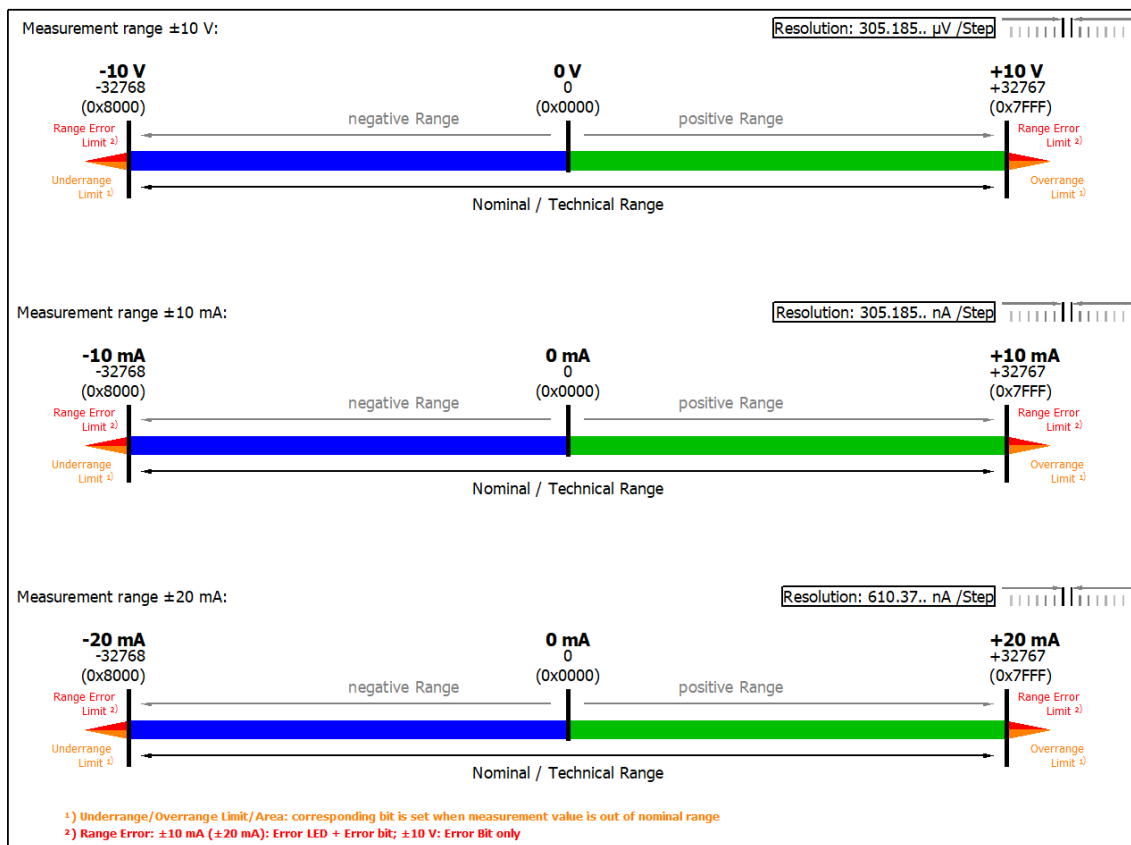

Fig. 204: Measurement ranges ± 10 V, ± 10 mA and ± 20 mA (applicable as given by 'X' by the following table)

Terminal	Measurement range		
	± 10 V	± 10 mA	± 20 mA
EL310x	X	-	-
EL3112-0011	-	-	X
EL3142-0010	-	X	-

EL311x, EL314x

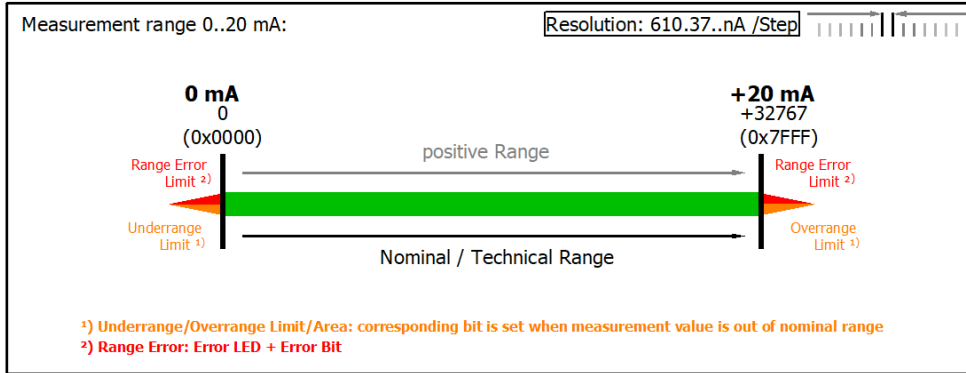

Fig. 205: Measurement range 0...20 mA

EL312x, EL315x

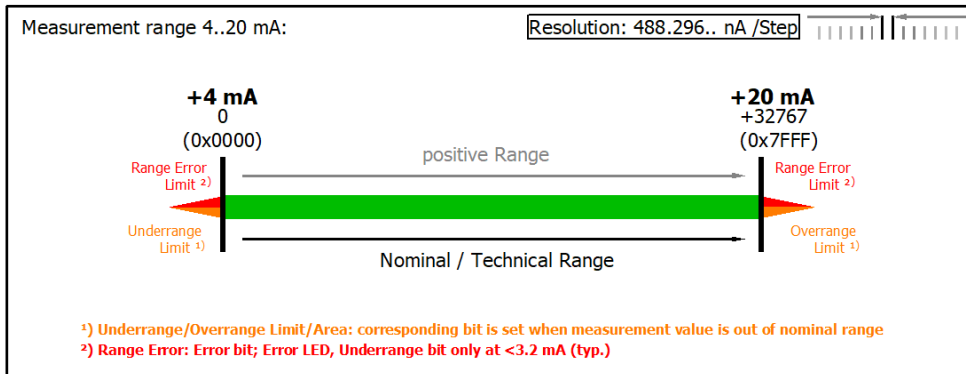

Fig. 206: Measurement range 4...20 mA

EL316x

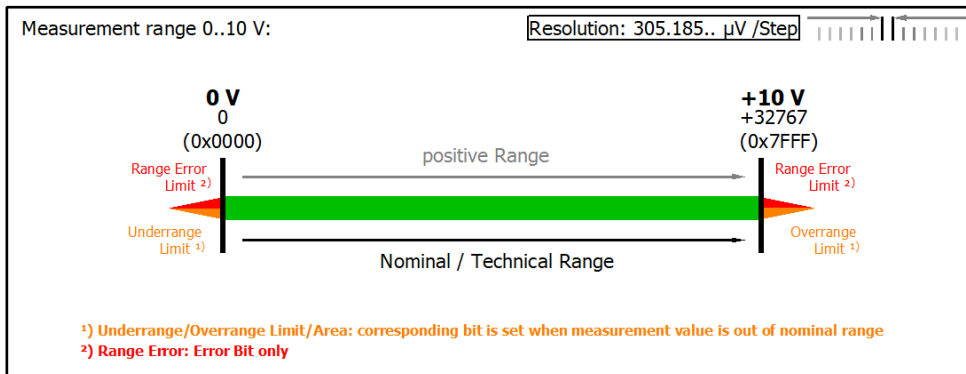
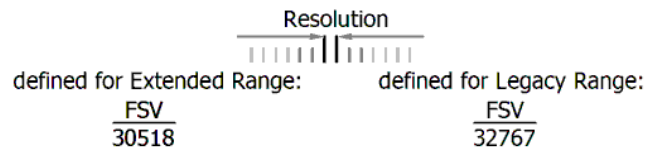

Fig. 207: Measurement range 0...10 V

EL3174, EL3174-00xx scaler: extended range/ legacy range

The EL3174 or the EL3174-00xx terminal respectively has the scaler (AI Advanced settings Object 0x80nD:12 [▶ 466]) “Extended Range” default set. This type of scaling allows an exceeding of the positive or negative value of approx. 7%. The technical useable range is within -107% to +107% of the respective full scale value. Example: the full scale value is ±10 V, so the technical range is -10.7 V to +10.7 V. The Legacy Range however provides the conventional range from -100% to +100% (e.g. usable range -10 V to +10 V) and +100% correspond to +32767 (-100% to -32768).

For the Extended Range 100% of a 16 bit PDO value ±30518 (0x7736) have been defined. Therefore resulting is the meaning of a bit given by the (user selected measurement range) respective full scale value (FSV) as follows:



Diagrams of all measurement ranges are shown as follows:

Measurement range ±10 V (bipole):

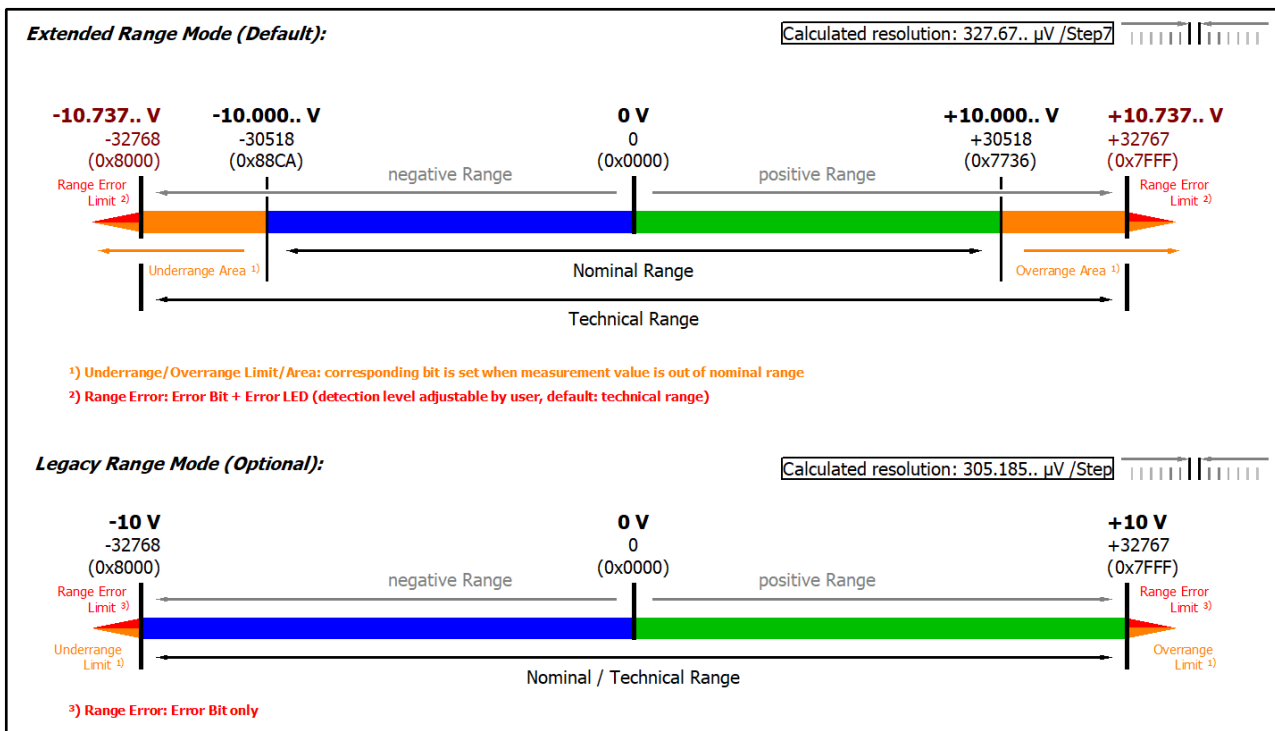

Fig. 208: EL3172, EL3174, EL3174-0002, EL3174-0090: measurement range -10...+10 V

Measurement range ± 3 V (bipole):

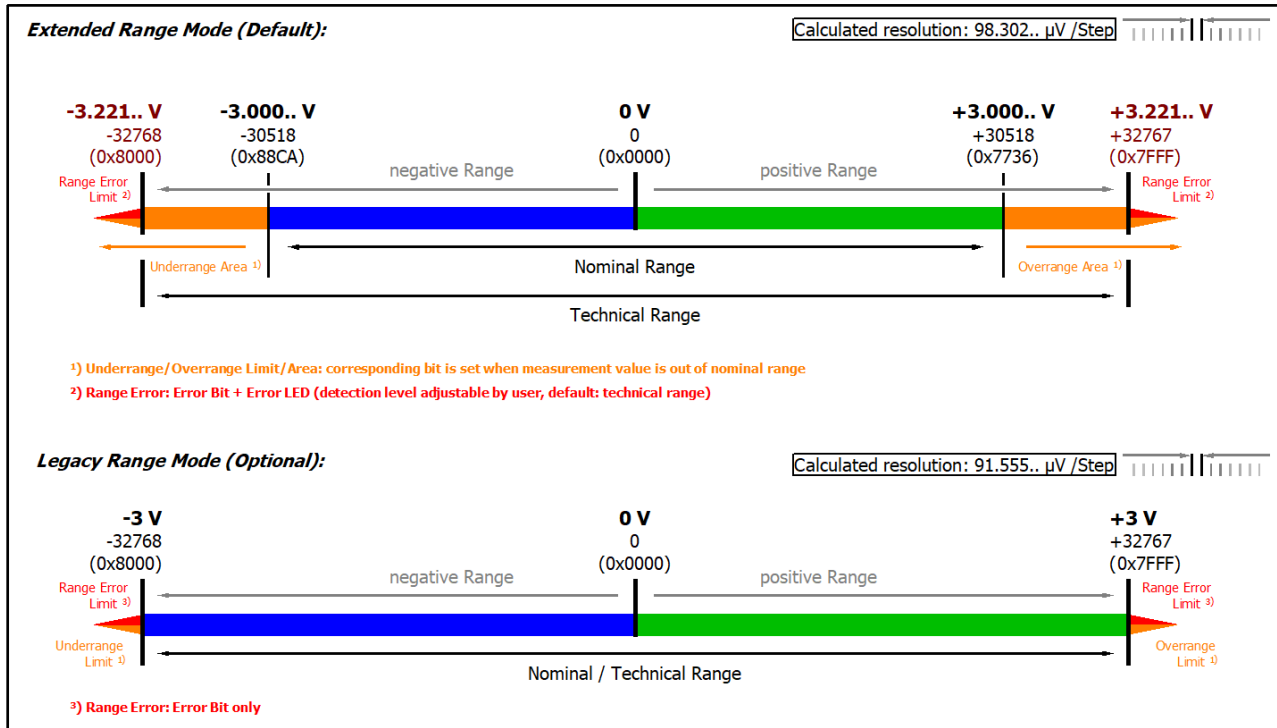

Fig. 209: EL3174-0032: measurement range -3...+3 V

Measurement range ± 30 V (bipole):

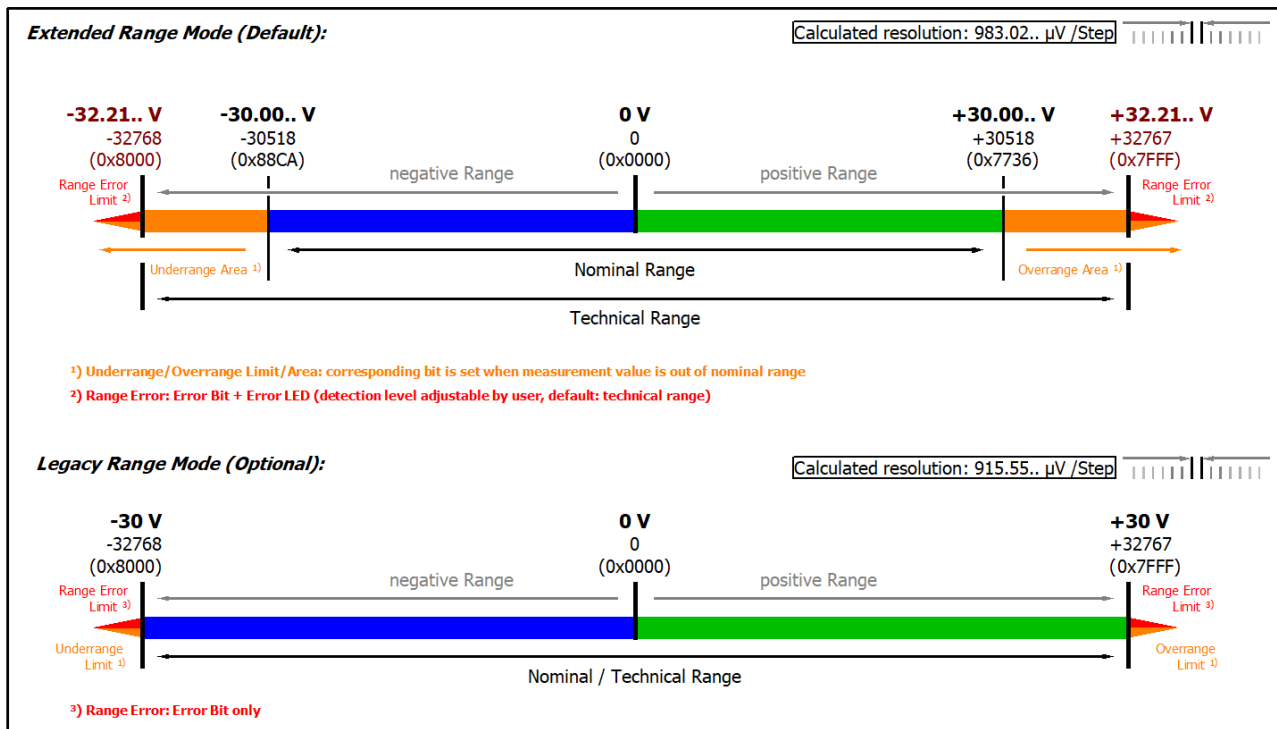

Fig. 210: EL3174-0042: measurement range -30...+30 V

Measurement range ± 60 V (bipole):

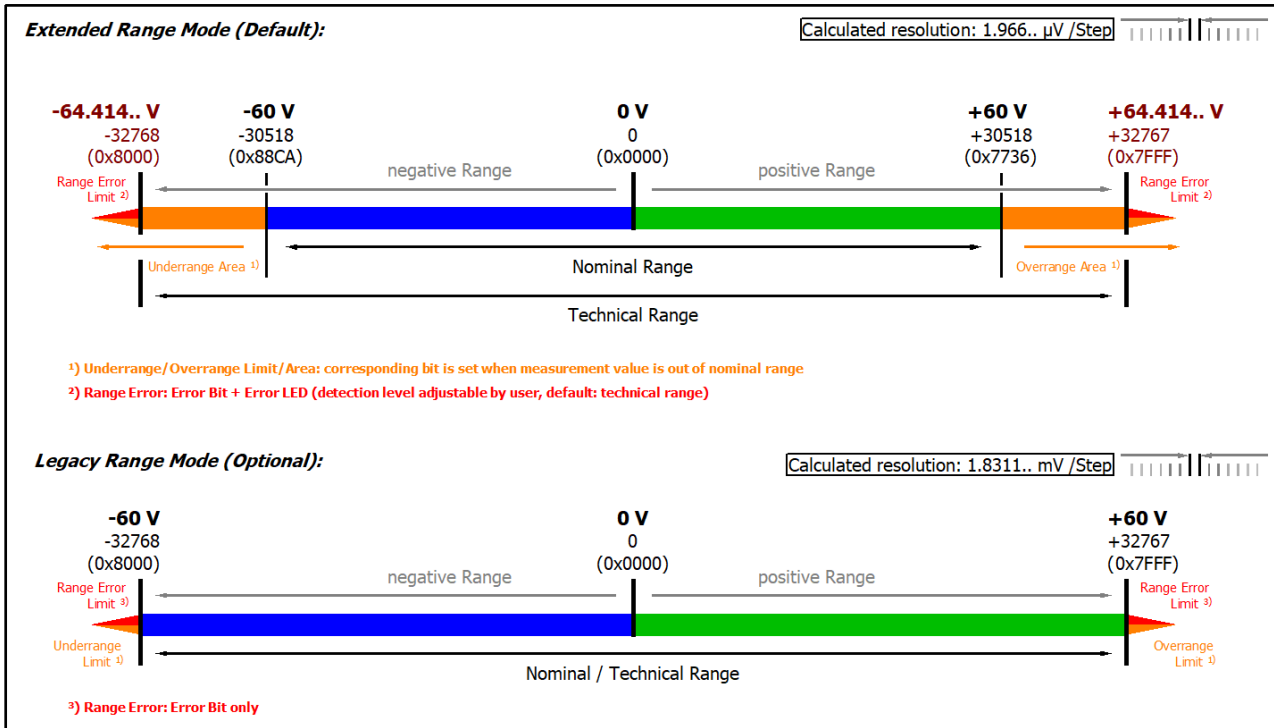
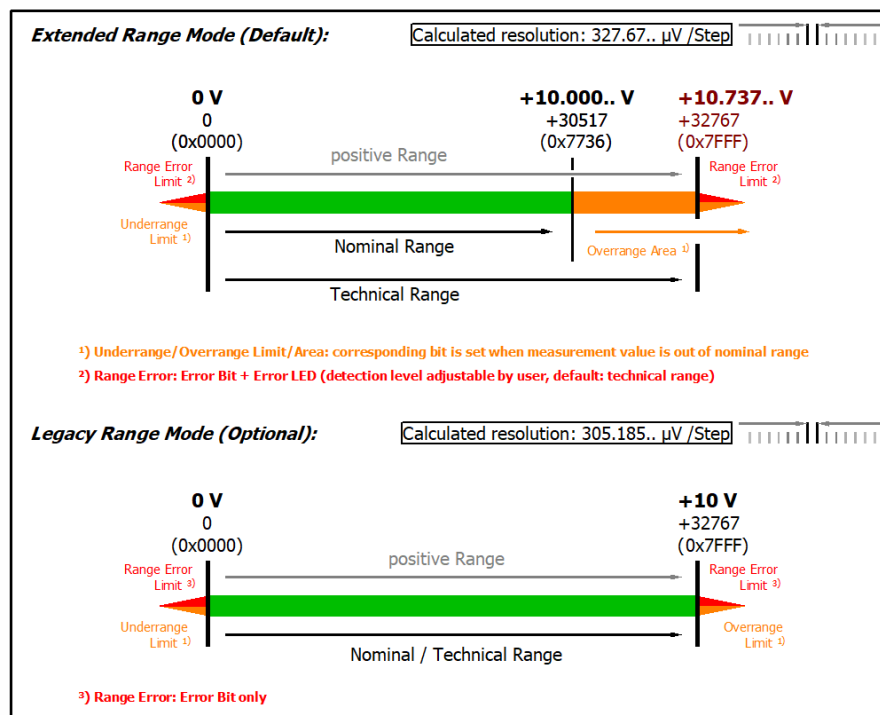

Fig. 211: EL3174-0042: measurement range -60...+60 V

Measurement range 0...10 V (unipole):



Technical note: The detection level for underrange and range error of 0 value area is located at -0.1 V (-1% of the full scale value). This has been configured to prevent a misleading setting of the error bit. The process data value don't undercut 0x0000 then.

Fig. 212: EL3172, EL3174, EL3174-0002, EL3174-0090: measurement range 0...10 V

Measurement range 0...3 V (unipole):

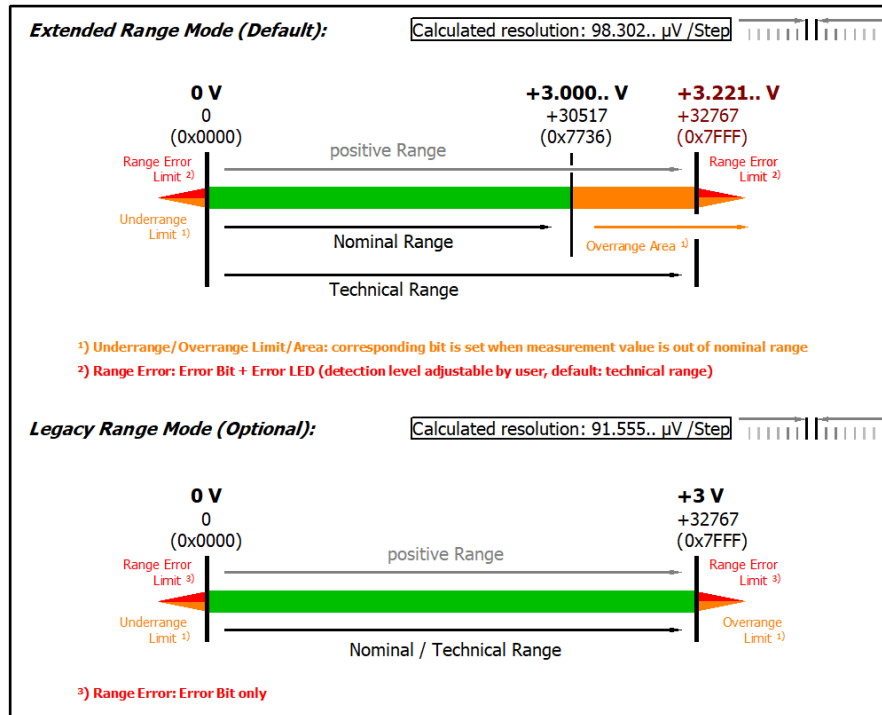

Technical note: The detection level for underrange and range error of 0 value area is located at -0.1 V (-1% of the full scale value). This has been configured to prevent a misleading setting of the error bit. The process data value don't undercut 0x0000 then.

Fig. 213: EL3174-0032: measurement range 0...3 V

Measurement range ± 20 mA (bipole):

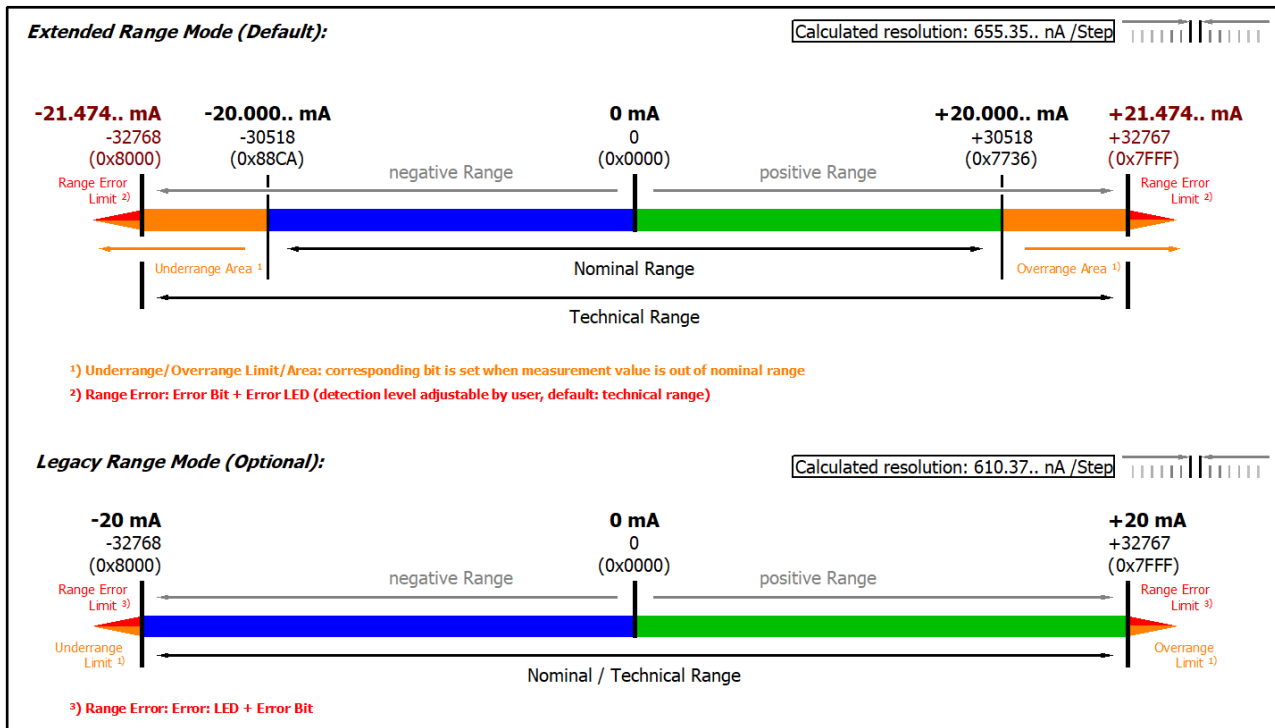
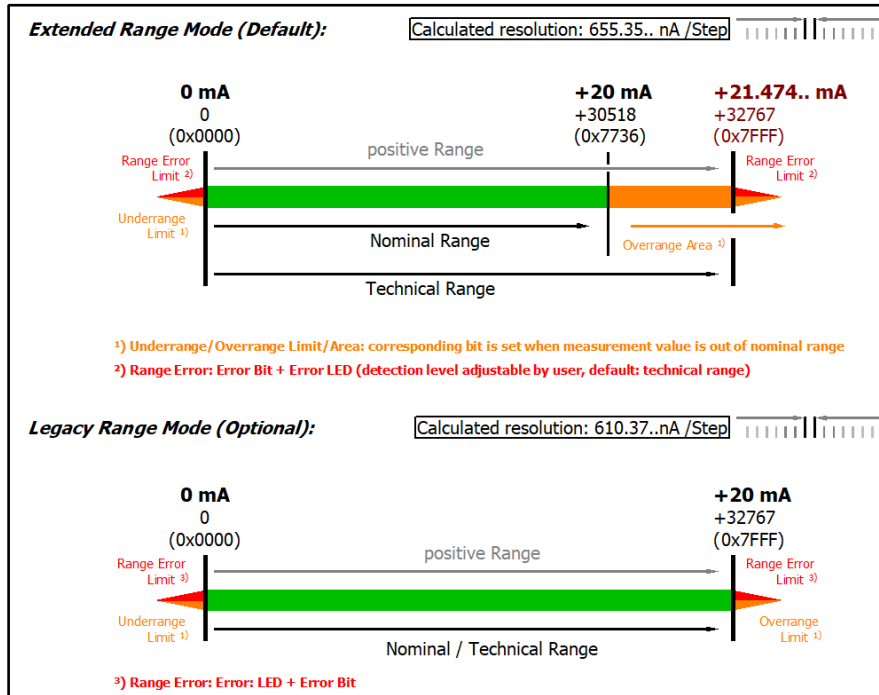

Fig. 214: EL3172, EL3174, EL3174-00xx: measurement range -20...+20 mA

Measurement range 0...20 mA (current loop):



Technical note: The detection level for underrange and range error of 0 value area is located at -0.2 mA (-1% of the full scale value). This has been configured to prevent a misleading setting of the error bit. The process data value don't undercuts 0x0000 then.

Fig. 215: EL3172, EL3174, EL3174-00xx: measurement range 0...20 mA

Measurement range 4...20 mA (current loop):

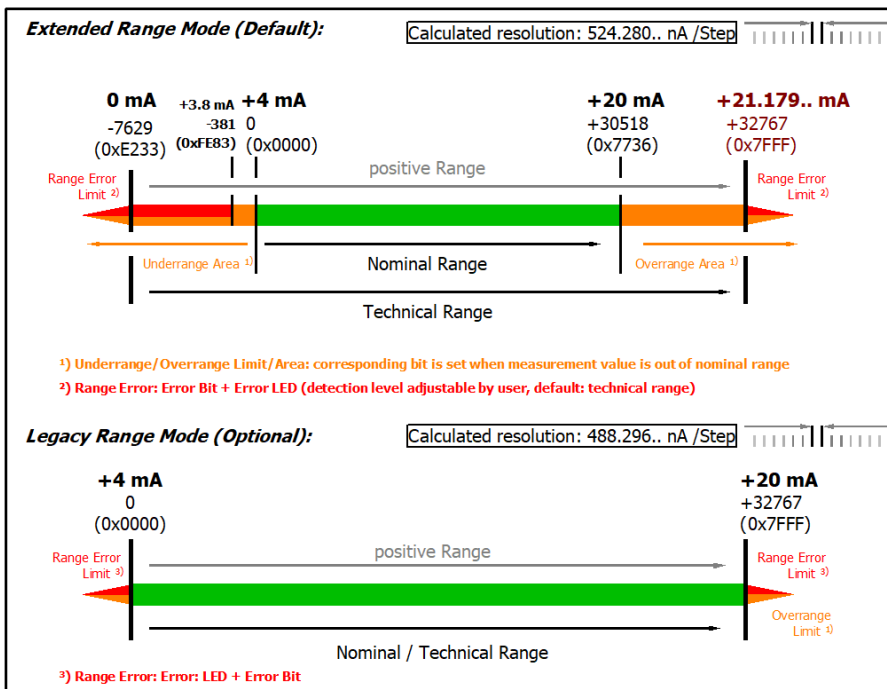

Technical note: The detection level for underrange and range error of 0 value area is located at 3.8 mA (-1% of the FSV full scale vale). This has been configured to prevent a misleading setting of the error bit.

Fig. 216: EL3172, EL3174, EL3174-00xx: measurement range 4...20 mA

Measurement range 4...20 mA/ NAMUR NE43 (current loop):

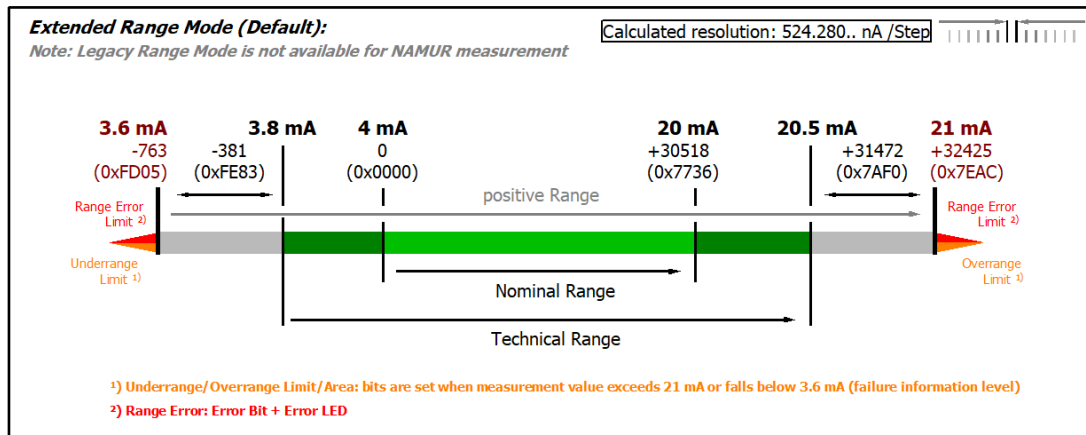

Fig. 217: EL3172, EL3174, EL3174-00xx: measurement range 4...20 mA (NAMUR NE43)

Calibration

Vendor calibration, index [0x80n0:0B](#) [[▶ 297](#)]

The vendor calibration is enabled via index [0x80n0:0B](#) [[▶ 297](#)]. Parameterization takes place via the indices

- [0x80nF:01](#) [[▶ 298](#)] Vendor calibration: Offset
- [0x80nF:02](#) [[▶ 298](#)] Vendor calibration: Gain

User calibration, index [0x80n0:0A](#) [[▶ 297](#)]

The user calibration is enabled via index [0x80n0:0A](#) [[▶ 297](#)]. Parameterization takes place via the indices

- [0x80n0:17](#) [[▶ 297](#)] User calibration: Offset
- [0x80n0:18](#) [[▶ 297](#)] User calibration: Gain

User scaling, index [0x80n0:01](#) [[▶ 297](#)]

The user scaling is enabled via index [0x80n0:01](#) [[▶ 297](#)]. Parameterization takes place via the indices

- [0x80n0:11](#) [[▶ 297](#)] User scaling: Offset
- [0x80n0:12](#) [[▶ 297](#)] User scaling: Gain

● **Manufacturer calibration**



The vendor reserves the authority for the basic calibration of the terminals. Therefore, the vendor calibration cannot be changed.

5.4.5 Fast mode

The Fast mode in Beckhoff EtherCAT Terminals has developed historically and is an operating mode with which EL Terminals, primarily the EL31xx and EL41xx groups (analog input/output terminals), can be operated with a considerably faster conversion time. Hence, an analog input value can be converted more quickly/more often or output via the controller accordingly. This is achieved at the expense of other features, therefore consideration is required.

If an EL Terminal supports this mode, this is indicated in the relevant documentation.

There are two groups of terminals that support the FastMode:

- Prototypes of EL31x2 and EL41x2, with product launch before 2009:
 You can switch the two-channel analog input and output terminals into *Fast Mode* by **switching off the second channel**. When operating with a single channel (*Fast Mode*) the terminal's conversion time is

about one third less than it is when operating two channels. You can find the precise figures for the conversion times in single-channel and two-channel operation in the technical data for the each particular terminal.

- EL31xx and EL41xx from year of manufacture 2009

CoE access can be deactivated in these terminals (if this is possible according to the documentation). All existing channels can convert faster as a result of this.

In EL31x2 terminals the Fast mode is automatic enabled but disabled for CoE access.

Here is an example for each group.

FastMode by means of channel deactivation

Example 1

You can switch the second input channel on and off on the *Process data* tab of the EL3101 under *PDO assignment* with the aid of the check box (see the red arrow).

The screenshot shows the 'Process Data' configuration window for an EL3101 terminal. The 'PDO Assignment (0x1C13)' section contains a list of PDOs with checkboxes. A red arrow points to the checkbox for '0x1A01', which is currently unchecked. The 'PDO List' section shows two channels: 'Channel 1' (Index 0x1A00) and 'Channel 2' (Index 0x1A01). The 'PDO Content (0x1A00)' section shows two entries: 'Status' (Index 0x3101:01) and 'Value' (Index 0x3101:02).

SM	Size	Type	Flags
0	246	MbxOut	
1	246	MbxIn	
2	0	Outputs	
3	3	Inputs	

Index	Size	Name	Flags	SM	SU
0x1A00	3.0	Channel 1	F	3	0
0x1A01	3.0	Channel 2	F		0

Index	Size	Offs	Name	Type
0x3101:01	1.0	0.0	Status	BYTE
0x3101:02	2.0	1.0	Value	INT
		3.0		

Fig. 218: Switch input channel on and off

Example 2

You can switch the second output channel on and off on the *Process data* tab of the EL4101 under *PDO assignment* with the aid of the check box (see the red arrow).

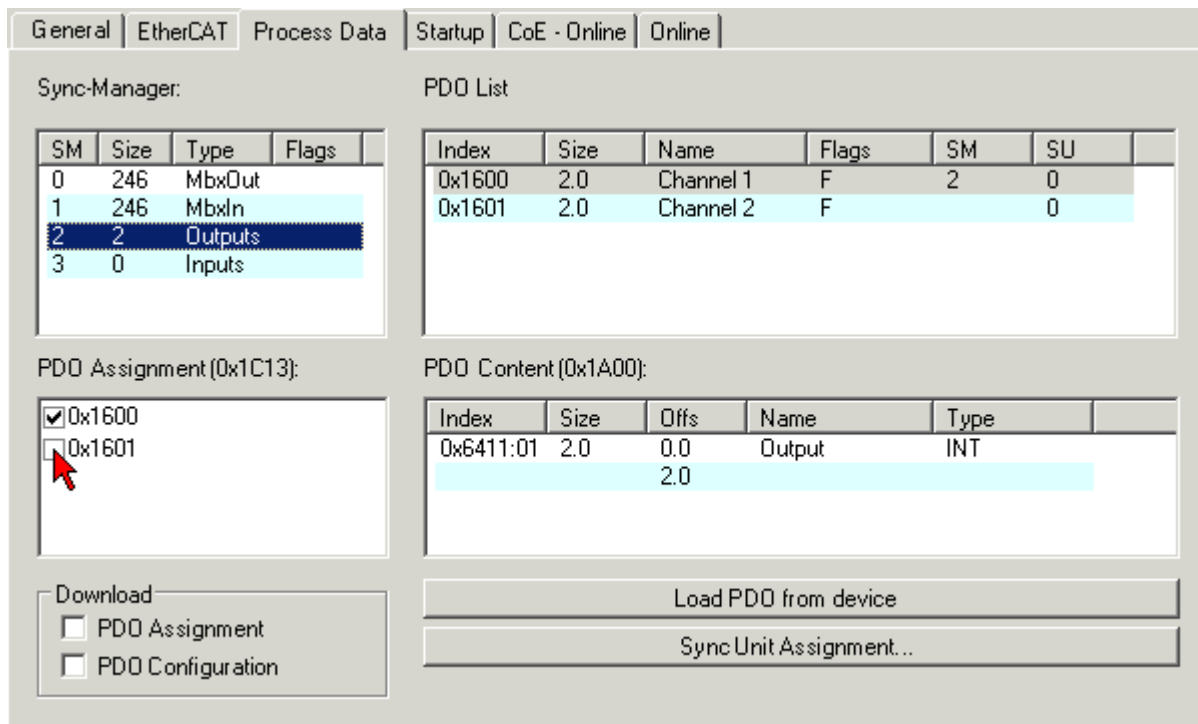

Fig. 219: Switch output channel on and off

FastMode by means of CoE deactivation

To disable CoE support for input terminals, a

```
PS CoE 0x1C33:01 0x8001 (32769) Sync mode
```

must be entered in the StartUp list in the System Manager for the terminal. This deactivates the CoE later in SAFEOP and OP.

FastMode is activated by the entry "0x80nn" in the "Sync mode" object, while "nn" specifies the synchronization mode.

- **Filter deactivation for input terminals**
i If FastMode is enabled, filter mode (0x80n0:06) must be disabled!

- **CoE deactivation for output terminals**
i For output terminals the upper entry must be implemented for the object 0x1C32:01.

More generally, the mailbox traffic of this terminal is turned off by this FastMode.

The CoE access can be reactivated by writing the original value or, for example, x00 in the PREOP phase after CoE 0x1C32:01 or 0x1C33:01. See the entries in the synchronization mode overview regarding this.

5.5 TwinSAFE SC

5.5.1 TwinSAFE SC - operating principle

The TwinSAFE SC (Single Channel) technology enables the use of standard signals for safety tasks in any networks of fieldbuses. To do this, EtherCAT Terminals from the areas of analog input, angle/displacement measurement or communication (4...20 mA, incremental encoder, IO-Link, etc.) are extended by the TwinSAFE SC function. The typical signal characteristics and standard functionalities of the I/O components are retained. TwinSAFE SC I/Os have a yellow strip at the front of the housing to distinguish them from standard I/Os.

The TwinSAFE SC technology enables communication via a TwinSAFE protocol. These connections can be distinguished from the usual safe communication via Safety over EtherCAT.

The data of the TwinSAFE SC components are transferred via a TwinSAFE protocol to the TwinSAFE logic, where they can be used in the context of safety-relevant applications. Detailed examples for the correct application of the TwinSAFE SC components and the respective normative classification, which were confirmed/calculated by TÜV SÜD, can be found in the [TwinSAFE application manual](#).

5.5.2 TwinSAFE SC - configuration

The TwinSAFE SC technology enables communication with standard EtherCAT terminals via the Safety over EtherCAT protocol. These connections use another checksum, in order to be able to distinguish between TwinSAFE SC and TwinSAFE. Eight fixed CRCs can be selected, or a free CRC can be entered by the user.

By default the TwinSAFE SC communication channel of the respective TwinSAFE SC component is not enabled. In order to be able to use the data transfer, the corresponding TwinSAFE SC module must first be added under the Slots tab. Only then is it possible to link to a corresponding alias device.

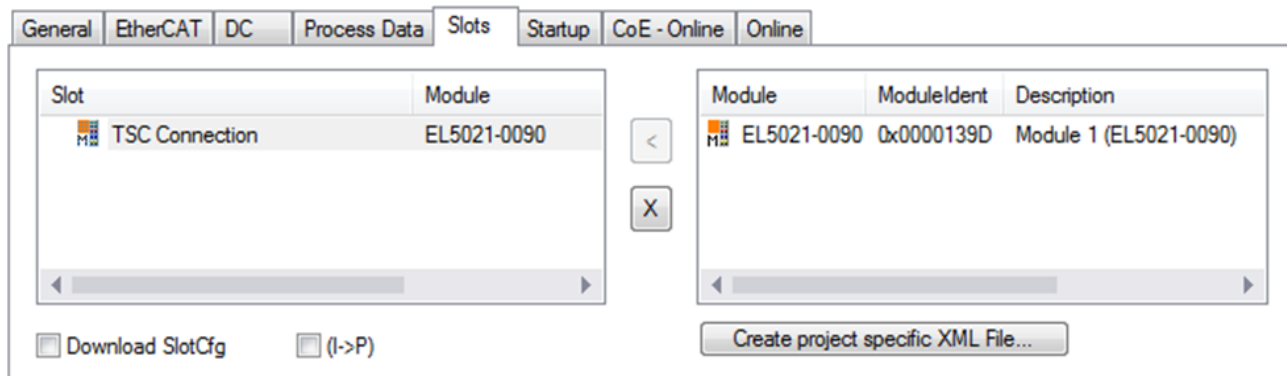

Fig. 220: Adding the TwinSAFE SC process data under the component, e.g. EL5021-0090

Additional process data with the ID TSC Inputs, TSC Outputs are generated (TSC - TwinSAFE Single Channel).

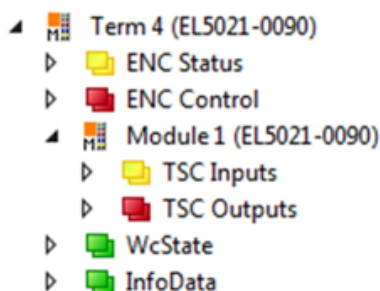

Fig. 221: TwinSAFE SC component process data, example EL5021-0090

A TwinSAFE SC connection is added by adding an alias devices in the safety project and selecting TSC (*TwinSAFE Single Channel*)

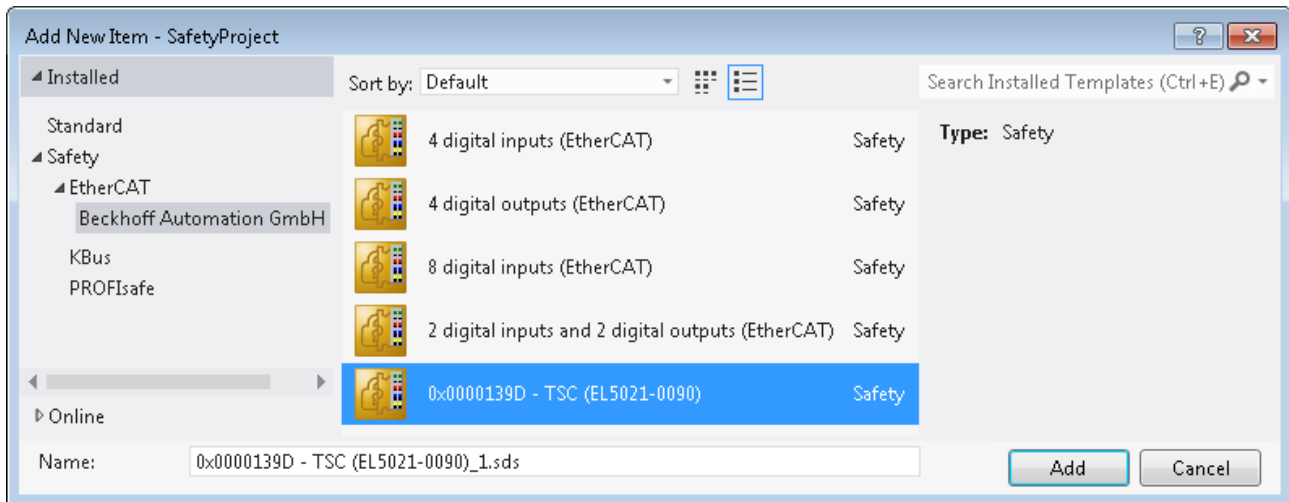



Fig. 222: Adding a TwinSAFE SC connection

After opening the alias device by double-clicking, select the Link button  next to *Physical Device*, in order to create the link to a TwinSAFE SC terminal. Only suitable TwinSAFE SC terminals are offered in the selection dialog.

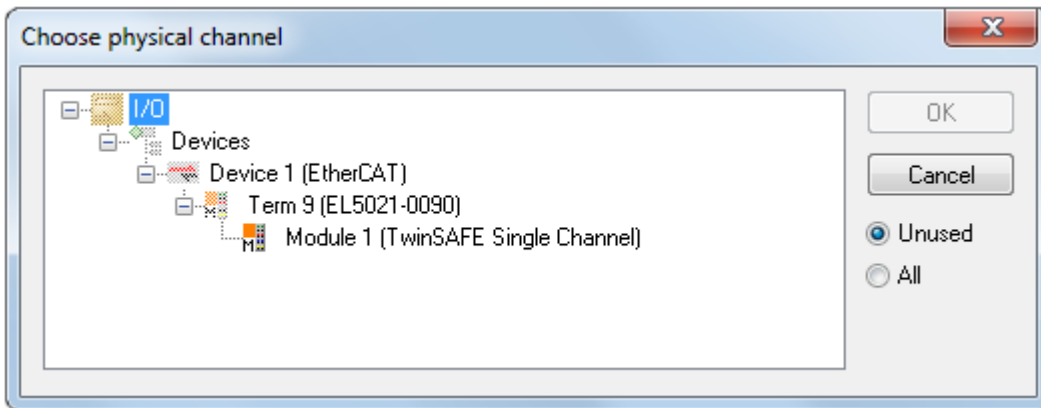

Fig. 223: Creating a link to TwinSAFE SC terminal

The CRC to be used can be selected or a free CRC can be entered under the Connection tab of the alias device.

Entry Mode	Used CRCs
TwinSAFE SC CRC 1 master	0x17B0F
TwinSAFE SC CRC 2 master	0x1571F
TwinSAFE SC CRC 3 master	0x11F95
TwinSAFE SC CRC 4 master	0x153F1
TwinSAFE SC CRC 5 master	0x1F1D5
TwinSAFE SC CRC 6 master	0x1663B
TwinSAFE SC CRC 7 master	0x1B8CD
TwinSAFE SC CRC 8 master	0x1E1BD

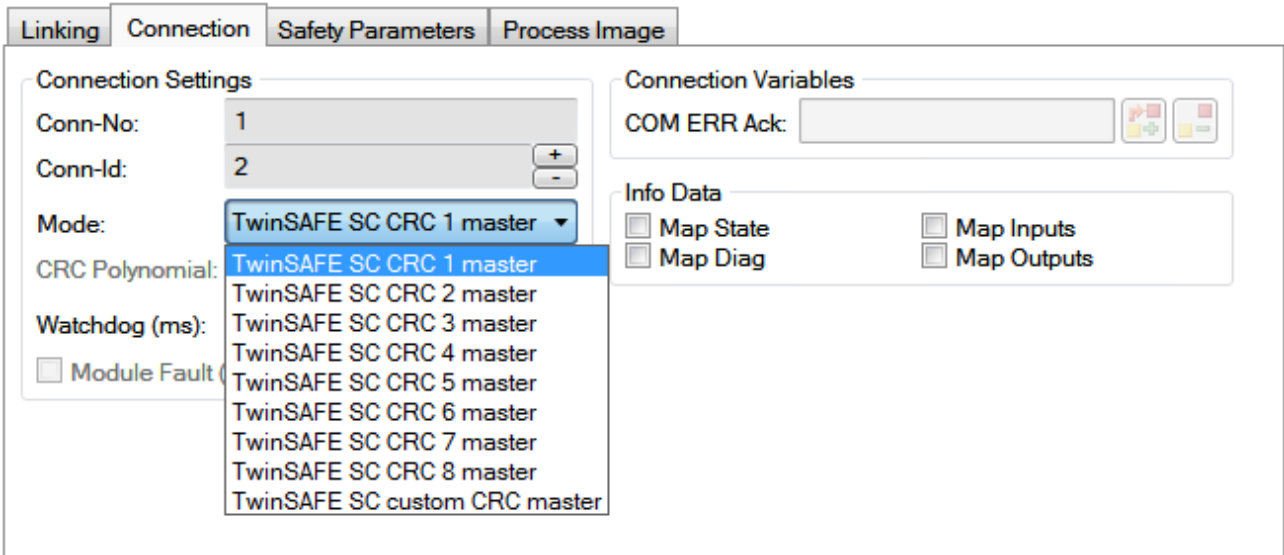

Fig. 224: Selecting a free CRC

These settings must match the settings in the CoE objects of the TwinSAFE SC component. The TwinSAFE SC component initially makes all available process data available. The *Safety Parameters* tab typically contains no parameters. The process data size and the process data themselves can be selected under the *Process Image* tab.

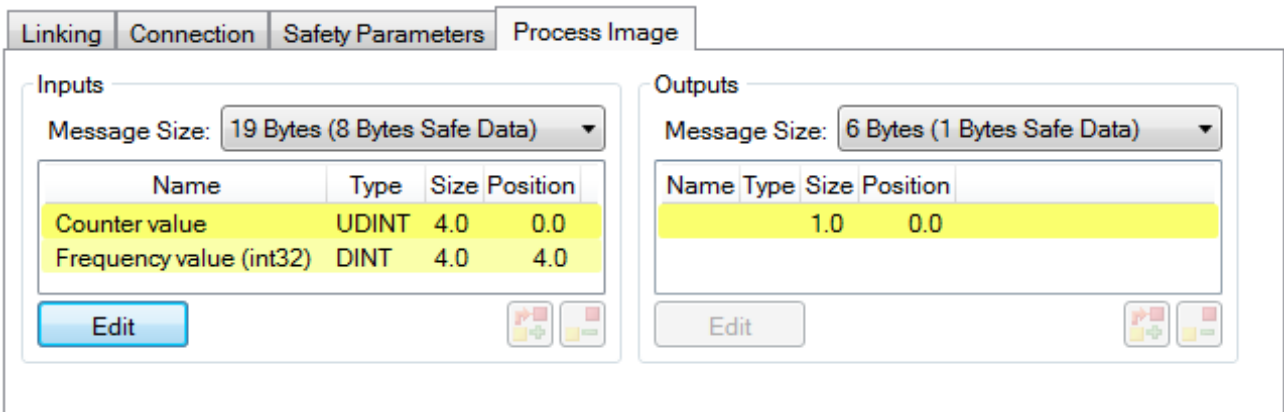

Fig. 225: Selecting the process data size and the process data

The process data (defined in the ESI file) can be adjusted to user requirements by selecting the *Edit* button in the dialog *Configure I/O element(s)*.

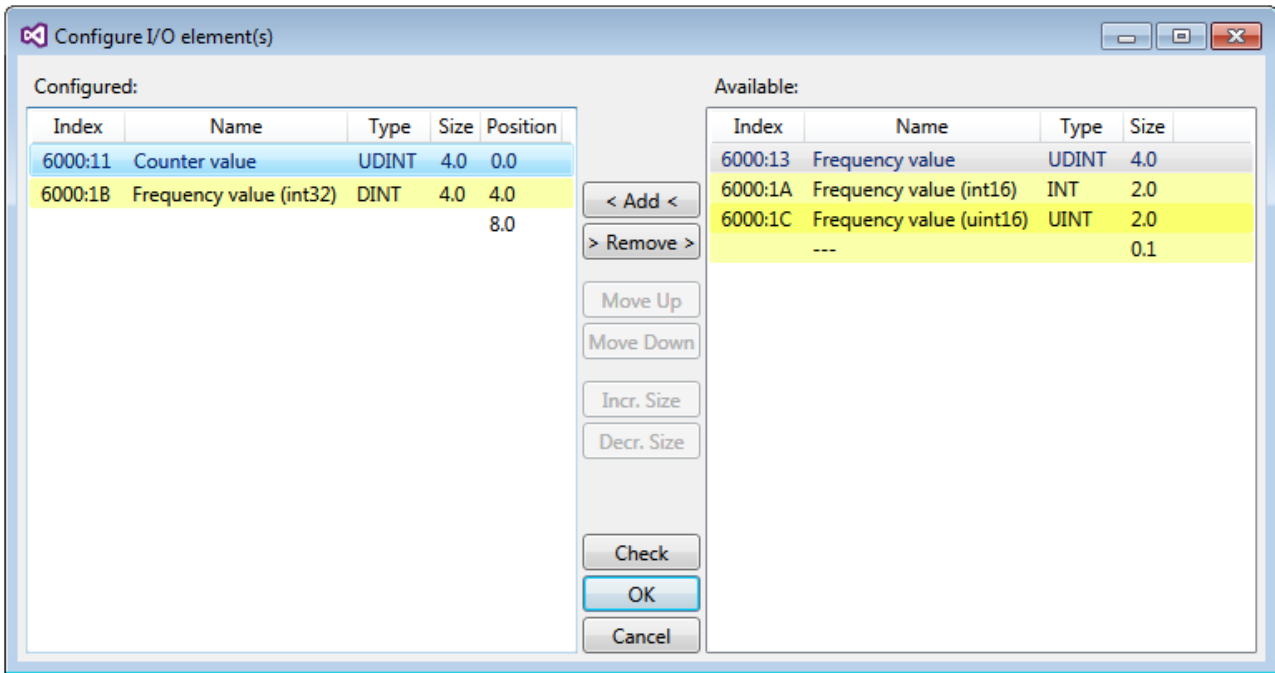

Fig. 226: Selection of the process data

The safety address together with the CRC must be entered on the TwinSAFE SC slave side. This is done via the CoE objects under *TSC settings* of the corresponding TwinSAFE SC component (here, for example, EL5021-0090, 0x8010: 01 and 0x8010: 02). The address set here must also be set in the *alias device* as *FSoE* address under the *Linking* tab.

Under the object 0x80n0:02 Connection Mode the CRC to be used is selected or a free CRC is entered. A total of 8 CRCs are available. A free CRC must start with 0x00ff in the high word.

8010:0	TSC Settings	RW	> 2 <
8010:01	Address	RW	0x0000 (0)
8010:02	Connection Mode	RW	TwinSAFE SC CRC1 master (97039)

Fig. 227: CoE objects 0x8010:01 and 0x8010:02

Object TSC Settings

Depending on the terminal, the index designation of the configuration object *TSC Settings* can vary. Example:

- EL3214-0090 and EL3314-0090, TSC Settings, Index 8040
- EL5021-0090, TSC Settings, Index 8010
- EL6224-0090, TSC Settings, Index 800F

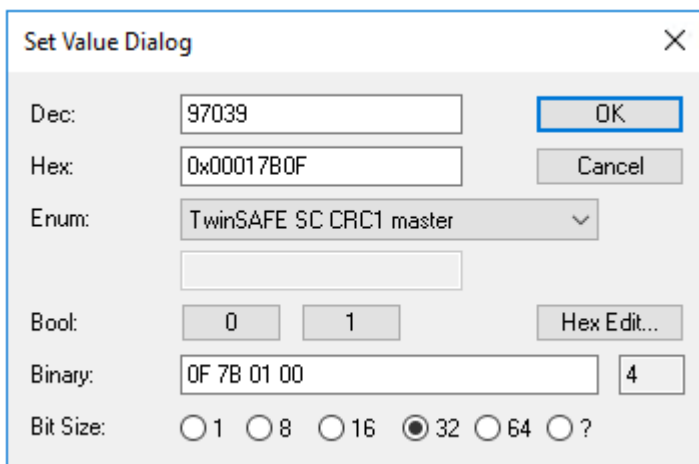

Fig. 228: Entering the safety address and the CRC

i TwinSAFE SC connections

If several TwinSAFE SC connections are used within a configuration, a different CRC must be selected for each TwinSAFE SC connection.

5.5.3 TwinSAFE SC process data EL31x4-0090

The EL31x4-0090 transmits the following process data to the TwinSAFE logic:

Index	Name	Type	Size
0x6000:11	AI Module 1. Value	INT	2.0
0x6010:11	AI Module 2. Value	INT	2.0
0x6020:11	AI Module 3. Value	INT	2.0
0x6030:11	AI Module 4. Value	INT	2.0

The process data of all four channels are transmitted by default. Via the "Process Image" tab individual channels can be completely deselected in the Safety Editor.

Depending on the TwinCAT 3.1 version, process data can be renamed automatically when linking to the Safety Editor.

i TwinSAFE SC Objekte

TwinSAFE SC objects are listed in chapter [Objects TwinSAFE Single Channel \(EL31x4-0090\)](#) [► 276].

5.5.4 Objects TwinSAFE Single Channel (EL31x4-0090)

Index 1600 TSC RxPDO-Map Master Message

Index (hex)	Name	Meaning	Data type	Flags	Default
1600:0	TSC RxPDO-Map Master Message	PDO Mapping RxPDO	UINT8	RO	0x04 (4 _{dec})
1600:01	SubIndex 001	1. PDO Mapping entry (object 0x7040 (TSC Master Frame Elements), entry 0x01 (TSC__Master Cmd))	UINT32	RO	0x7040:01, 8
1600:02	SubIndex 002	2. PDO Mapping entry (8 bits align)	UINT32	RO	0x0000:00, 8
1600:03	SubIndex 003	3. PDO Mapping entry (object 0x7040 (TSC Master Frame Elements), entry 0x03 (TSC__Master CRC_0))	UINT32	RO	0x7040:03, 16
1600:04	SubIndex 004	4. PDO Mapping entry (object 0x7040 (TSC Master Frame Elements), entry 0x02 (TSC__Master ConnID))	UINT32	RO	0x7040:02, 16

Index 1A08 TxPDO-Map Slave Message

Index (hex)	Name	Meaning	Data type	Flags	Default
1A08:0	TxPDO-Map Slave Message	PDO Mapping TxPDO	UINT8	RW	0x0A (10 _{dec})
1A08:01	SubIndex 001	1. PDO Mapping entry (object 0x6040 (TSC Slave Frame Elements), entry 0x01 (TSC__Slave Cmd))	UINT32	RW	0x6040:01, 8
1A08:02	SubIndex 002	2. PDO Mapping entry (object 0x6000 (AI Inputs), entry 0x11 (Value))	UINT32	RW	0x6000:11, 16
1A08:03	SubIndex 003	3. PDO Mapping entry (object 0x6040 (TSC Slave Frame Elements), entry 0x03 (TSC__Slave_CRC_0))	UINT32	RW	0x6040:03, 16
1A08:04	SubIndex 004	4. PDO Mapping entry (object 0x6010 (AI Inputs), entry 0x11 (Value))	UINT32	RW	0x6010:11, 16
1A08:05	SubIndex 005	5. PDO Mapping entry (object 0x6040 (TSC Slave Frame Elements), entry 0x04 (TSC__Slave_CRC_1))	UINT32	RW	0x6040:04, 16
1A08:06	SubIndex 006	6. PDO Mapping entry (object 0x6020 (AI Inputs), entry 0x11 (Value))	UINT32	RW	0x6020:11, 16
1A08:07	SubIndex 007	7. PDO Mapping entry (object 0x6040 (TSC Slave Frame Elements), entry 0x05 (TSC__Slave_CRC_2))	UINT32	RW	0x6040:05, 16
1A08:08	SubIndex 008	8. PDO Mapping entry (object 0x6030 (AI Inputs), entry 0x11 (Value))	UINT32	RW	0x6030:11, 16
1A08:09	SubIndex 009	9. PDO Mapping entry (object 0x6040 (TSC Slave Frame Elements), entry 0x06 (TSC__Slave_CRC_3))	UINT32	RW	0x6040:06, 16
1A08:0A	SubIndex 010	10. PDO Mapping entry (object 0x6040 (TSC Slave Frame Elements), entry 0x02 (TSC__Slave ConnID))	UINT32	RW	0x6040:02, 16

Index 6040 TSC Slave Frame Elements

Index (hex)	Name	Meaning	Data type	Flags	Default
6040:0	TSC Slave Frame Elements	Max. Subindex	UINT8	RO	0x06 (6 _{dec})
6040:01	TSC__Slave Cmd	reserved	UINT8	RO	0x00 (0 _{dec})
6040:02	TSC__Slave ConnID	reserved	UINT16	RO	0x0000 (0 _{dec})
6040:03	TSC__Slave CRC_0	reserved	UINT16	RO	0x0000 (0 _{dec})
6040:04	TSC__Slave CRC_1	reserved	UINT16	RO	0x0000 (0 _{dec})
6040:05	TSC__Slave CRC_2	reserved	UINT16	RO	0x0000 (0 _{dec})
6040:06	TSC__Slave CRC_3	reserved	UINT16	RO	0x0000 (0 _{dec})

Index 7040 TSC Master Frame Elements

Index (hex)	Name	Meaning	Data type	Flags	Default
7040:0	TSC Master Frame Elements	Max. Subindex	UINT8	RO	0x03 (3 _{dec})
7040:01	TSC__Master Cmd	reserved	UINT8	RO	0x00 (0 _{dec})
7040:02	TSC__Master ConnID	reserved	UINT16	RO	0x0000 (0 _{dec})
7040:03	TSC__Master CRC_0	reserved	UINT16	RO	0x0000 (0 _{dec})

Index 8040 TSC Settings

Index (hex)	Name	Meaning	Data type	Flags	Default
8040:0	TSC Settings	Max. Subindex	UINT8	RO	0x02 (2 _{dec})
8040:01	Address	TwinSAFE SC Address	UINT16	RO	0x0000 (0 _{dec})
8040:02	Connection Mode	Selection of the TwinSAFE SC CRC	UINT32	RO	0x00000000 (0 _{dec})

5.6 CoE object description and parameterization

● EtherCAT XML Device Description



The display matches that of the CoE objects from the EtherCAT XML Device Description. We recommend downloading the latest XML file from the download area of the [Beckhoff website](#) and installing it according to installation instructions.

Overview

The CoE overview contains objects for different intended applications:

Object overview

- Restore object
- Configuration data
- Input data
- Output data
- Standard objects

● Note regarding EL31x2 terminals before rev. no. EL31x2-0000-0016



The following CoE object list additionally contains the objects for the 2-channel input terminals before rev. no. EL31x2-0000-0016. These objects are mirrored to the standardized objects of MDP profiles 300 (analog inputs). When a new configuration is created in TwinCAT, we recommend using the standardized objects based on channel profile 300, although linking with the objects highlighted in color should be avoided. Older configurations are compatible in the event of replacement, see also section "[Process data](#)" [[▶ 244](#)].

● Note regarding firmware versions for EL31x2 terminals



For compatibility reasons, in addition to regular settings objects in CoE range 0x8000, the EL31x2 also support the predecessor objects in the range 0x4000. The settings objects in the range 0x4000 no longer show up in the CoE overview from the following FW versions, although they are still functionally supported:

EL3102-0000 FW12
 EL3112-0000 FW13
 EL3122-0000 FW13
 EL3142-0000 FW13
 EL3142-0010 FW11
 EL3152-0000 FW14
 EL3162-0000 FW13

5.6.1 EL310x

5.6.1.1 EL3101

5.6.1.1.1 Restore object

Index 1011 Restore default parameters

Index (hex)	Name	Meaning	Data type	Flags	Default
1011:0	Restore default parameters [▶ 503]	Restore default parameters	UINT8	RO	0x01 (1 _{dec})
1011:01	SubIndex 001	If this object is set to “ 0x64616F6C ” in the set value dialog, all backup objects are reset to their delivery state.	UINT32	RW	0x00000000 (0 _{dec})

5.6.1.1.2 Configuration data

Index 8000 AI settings

Index (hex)	Name	Meaning	Data type	Flags	Default
8000:0	AI Settings	Maximum subindex	UINT8	RO	0x18 (24 _{dec})
8000:01	Enable user scale [▶ 269]	User scale is active.	BOOLEAN	RW	0x00 (0 _{dec})
8000:02	Presentation [▶ 244]	0: Signed presentation 1: Unsigned presentation 2: Absolute value with MSB as sign Signed amount representation	BIT3	RW	0x00 (0 _{dec})
8000:05	Siemens bits [▶ 246]	The S5 bits are displayed in the three low-order bits	BOOLEAN	RW	0x00 (0 _{dec})
8000:06	Enable filter	Enable filter, which makes PLC-cycle-synchronous data exchange unnecessary	BOOLEAN	RW	0x00 (0 _{dec})
8000:07	Enable limit 1 [▶ 246]	Limit 1 enabled	BOOLEAN	RW	0x00 (0 _{dec})
8000:08	Enable limit 2 [▶ 246]	Limit 2 enabled	BOOLEAN	RW	0x00 (0 _{dec})
8000:0A	Enable user calibration [▶ 269]	Enabling of the user calibration	BOOLEAN	RW	0x00 (0 _{dec})
8000:0B	Enable vendor calibration [▶ 269]	Enabling of the vendor calibration	BOOLEAN	RW	0x01 (1 _{dec})
8000:0E	Swap limit bits [▶ 247]	Changing of the Limit Bits	BOOLEAN	RW	0x00 (0 _{dec})
80n0:11	User scale offset [▶ 269]	User scaling offset	INT16	RW	0x0000 (0 _{dec})
80n0:12	User scale gain [▶ 269]	User scaling gain. The gain is represented in fixed-point format, with the factor 2 ⁻¹⁶ . The value 1 corresponds to 65536 _{dec} (0x00010000) and is limited to ±0x7FFFF	INT32	RW	0x00010000 (65536 _{dec})
80n0:13	Limit 1 [▶ 246]	First limit value for setting the status bits	INT16	RW	0x0000 (0 _{dec})
80n0:14	Limit 2 [▶ 246]	Second limit value for setting the status bits	INT16	RW	0x0000 (0 _{dec})
80n0:15	Filter settings	This object determines the digital filter settings, if it is active via Enable filter (index 0x8000:06 [▶ 280]). The possible settings are sequentially numbered. 0: 50 Hz FIR 1: 60 Hz FIR 2: IIR 1 3: IIR 2 4: IIR 3 5: IIR 4 6: IIR 5 7: IIR 6 8: IIR 7 9: IIR 8	UINT16	RW	0x0000 (0 _{dec})
80n0:17	User calibration offset [▶ 269]	User offset compensation	INT16	RW	0x0000 (0 _{dec})
80n0:18	User calibration gain [▶ 269]	User calibration gain	INT16	RW	0x4000 (16384 _{dec})

***) since revision no. EL31xx-00xx-0016



The filter characteristics are set via index [0x8000:15](#) [\[▶ 280\]](#)

The filter frequencies are set for all channels of the EL31xx terminals centrally via index [0x8000:15](#) [\[▶ 280\]](#) (channel 1). All other corresponding indices 0x80n0:15 have no parameterization function!

5.6.1.1.3 Profile-specific objects (0x6000-0xFFFF)

The profile-specific objects have the same meaning for all EtherCAT slaves that support the profile 5001.

5.6.1.1.3.1 Input data

Index 6000 AI inputs

Index (hex)	Name	Meaning	Data type	Flags	Default
6000:0	AI inputs	Maximum subindex	INT16	RO	0x11 (17 _{dec})
6000:01	Underrange	Value below measuring range.	BOOLEAN	RO	0x00 (0 _{dec})
6000:02	Overrange	Measuring range exceeded.	BOOLEAN	RO	0x00 (0 _{dec})
6000:03	Limit 1	Limit value monitoring Limit 1 0: not active 1: value is smaller than limit value 1 2: value is larger than limit value 1 3: Value is equal to limit value 1	BIT2	RO	0x00 (0 _{dec})
6000:05	Limit 2	Limit value monitoring limit 2 0: not active 1: value is smaller than limit value 2 2: value is larger than limit value 2 3: Value is equal to limit value 2	BIT2	RO	0x00 (0 _{dec})
6000:07	Error	The error bit is set if the data is invalid (over-range, under-range)	BOOLEAN	RO	0x00 (0 _{dec})
6000:0E	Sync error	The Sync error bit is only required for DC mode. It indicates whether a synchronization error has occurred during the previous cycle. This means a SYNC signal was triggered in the EL31xx, although no new process data were available (0=OK, 1=NOK).	BOOLEAN	RO	0x00 (0 _{dec})
6000:0F	TxPDO State	Validity of the data of the associated TxPDO (0 = valid, 1 = invalid).	BOOLEAN	RO	0x00 (0 _{dec})
60n0:10	TxPDO Toggle	The TxPDO toggle is toggled by the slave when the data of the associated TxPDO is updated.	BOOLEAN	RO	0x00 (0 _{dec})
60n0:11	Value	Analog input date	INT16	RO	0x0000 (0 _{dec})

5.6.1.1.3.2 Configuration data (vendor-specific)

Index 800F AI vendor data

Index (hex)	Name	Meaning	Data type	Flags	Default
800F:0	AI vendor data	Maximum subindex	UINT8	RO	0x02 (2 _{dec})
800F:01	Calibration offset	Offset (vendor calibration)	INT16	RW	0x0000 (0 _{dec})
800F:02	Calibration gain	Gain (vendor calibration)	INT16	RW	0x4000 (16384 _{dec})

5.6.1.1.3.3 Information and diagnostic data

Index 800E AI internal data

Index (hex)	Name	Meaning	Data type	Flags	Default
800E:0	AI internal data	Maximum subindex	UINT8	RO	0x01 (1 _{dec})
800E:01	ADC raw value	ADC raw value	UINT16	RO	-

Index F000*** Modular device profile

Index (hex)	Name	Meaning	Data type	Flags	Default
F000:0	Modular device profile	General information for the modular device profile	UINT8	RO	0x02 (2 _{dec})
F000:01	Module index distance	Index spacing of the objects of the individual channels	UINT16	RO	0x0010 (16 _{dec})
F000:02	Maximum number of modules	Number of channels	UINT16	RO	<i>Max. Channels number of the terminal</i>

***) since revision no. EL31xx-00xx-0016

Index F008* Code word**

Index	Name	Meaning	Data type	Flags	Default
F008:0	Code word	reserved	UINT32	RW	0x00000000 (0 _{dec})

***) since revision no. EL31xx-00xx-0016

Index F009* Password protection**

Index (hex)	Name	Meaning	Data type	Flags	Default
F009:0	Password protection	Password protection user calibration [▶ 259]	UINT32	RW	0x00000000 (0 _{dec})

***) for EL31xx, see [note \[▶ 259\]](#)

Index F010* module list (for $1 \leq n \leq 4$, depends on number of channels)**

Index (hex)	Name	Meaning	Data type	Flags	Default
F010:0	Module list	Maximum subindex	UINT8	RW	0x0n
F010:0n	SubIndex 00n	Analog input profile (300)	UINT32	RW	0x0000012C (300 _{dec})

***) since revision no. EL31xx-00xx-0016

5.6.1.1.4 Standard objects**Standard objects (0x1000-0x1FFF)**

The standard objects have the same meaning for all EtherCAT slaves.

Index 1000 Device type

Index (hex)	Name	Meaning	Data type	Flags	Default
1000:0	Device type	Device type of the EtherCAT slave: the Lo-Word contains the CoE profile used (5001). The Hi-Word contains the module profile according to the modular device profile.	UINT32	RO	0x012C1389 (19665801 _{dec})

Index 1008 Device name

Index (hex)	Name	Meaning	Data type	Flags	Default
1008:0	Device name	Device name of the EtherCAT slave	STRING	RO	EL31xx

Index 1009 Hardware version

Index (hex)	Name	Meaning	Data type	Flags	Default
1009:0	Hardware version	Hardware version of the EtherCAT slave	STRING	RO	00

Index 100A Software version

Index (hex)	Name	Meaning	Data type	Flags	Default
100A:0	Software version	Firmware version of the EtherCAT slave	STRING	RO	-

Index 1018 Identity

Index (hex)	Name	Meaning	Data type	Flags	Default
1018:0	Identity	Information for identifying the slave	UINT8	RO	0x04 (4 _{dec})
1018:01	Vendor ID	Vendor ID of the EtherCAT slave	UINT32	RO	0x00000002 (2 _{dec})
1018:02	Product code	Product code of the EtherCAT slave	UINT32	RO	0xFFFF3052
1018:03	Revision	Revision number of the EtherCAT slave; the low word (bit 0-15) indicates the special terminal number, the high word (bit 16-31) refers to the device description	UINT32	RO	-
1018:04	Serial number	Serial number of the EtherCAT slave; the low byte (bit 0-7) of the low word contains the year of production, the high byte (bit 8-15) of the low word contains the week of production, the high word (bit 16-31) is 0	UINT32	RO	-

Index 10F0* Backup parameter handling**

Index (hex)	Name	Meaning	Data type	Flags	Default
10F0:0	Backup parameter handling	Information for standardized loading and saving of backup entries	UINT8	RO	0x01 (1 _{dec})
10F0:01	Checksum	Checksum across all backup entries of the EtherCAT slave	UINT32	RO	-

***) since revision no. EL31xx-00xx-0016

Index 1800 AI TxPDO-Par Standard Ch.1

Index (hex)	Name	Meaning	Data type	Flags	Default
1800:0	AI TxPDO-Par Standard Ch.1	PDO parameter TxPDO 1	UINT8	RO	0x06 (6 _{dec})
1800:06	Exclude TxPDOs	Specifies the TxPDOs (index of TxPDO mapping objects) that must not be transferred together with TxPDO 1	OCTET-STRING[2]	RO	01 1A

Index 1801 AI TxPDO-Par Compact Ch.1

Index (hex)	Name	Meaning	Data type	Flags	Default
1801:0	AI TxPDO-Par Compact Ch.1	PDO parameter TxPDO 2	UINT8	RO	0x06 (6 _{dec})
1801:06	Exclude TxPDOs	Specifies the TxPDOs (index of TxPDO mapping objects) that must not be transferred together with TxPDO 2	OCTET-STRING[2]	RO	00 1A

Index 1A00 AI TxPDO-Map Standard Ch.1

Index (hex)	Name	Meaning	Data type	Flags	Default
1A00:0	AI TxPDO-Map Standard Ch.1	PDO Mapping TxPDO	UINT8	RO	0x0B (11 _{dec})
1A00:01	SubIndex 001	1. PDO Mapping entry (object 0x6000 (AI Inputs), entry 0x01 (Underrange))	UINT32	RO	0x6000:01, 1
1A00:02	SubIndex 002	2. PDO Mapping entry (object 0x6000 (AI Inputs), entry 0x02 (Ovrange))	UINT32	RO	0x6000:02, 1
1A00:03	SubIndex 003	3. PDO Mapping entry (object 0x6000 (AI Inputs), entry 0x03 (Limit 1))	UINT32	RO	0x6000:03, 2
1A00:04	SubIndex 004	4. PDO Mapping entry (object 0x6000 (AI Inputs), entry 0x05 (Limit 2))	UINT32	RO	0x6000:05, 2
1A00:05	SubIndex 005	5. PDO Mapping entry (object 0x6000 (AI Inputs), entry 0x07 (Error))	UINT32	RO	0x6000:07, 1
1A00:06	SubIndex 006	6. PDO Mapping entry (1 bit align)	UINT32	RO	0x0000:00, 1
1A00:07	SubIndex 007	7. PDO Mapping entry (5 bits align)	UINT32	RO	0x0000:00, 5
1A00:08	SubIndex 008	8. PDO Mapping entry (object 0x6000 (AI Inputs), entry 0x0E (Sync Error))	UINT32	RO	0x6000:0E, 1
1A00:09	SubIndex 009	9. PDO Mapping entry (object 0x6000 (AI Inputs), entry 0x0F (TxPDO State))	UINT32	RO	0x6000:0F, 1
1A00:0A	SubIndex 010	10. PDO Mapping entry (object 0x6000 (AI Inputs), entry 0x10 (TxPDO Toggle))	UINT32	RO	0x6000:10, 1
1A00:0B	SubIndex 011	11. PDO Mapping entry (object 0x6000 (AI Inputs), entry 0x11 (Value))	UINT32	RO	0x6000:11, 16

Index 1A01 AI TxPDO-Map Compact Ch.1

Index (hex)	Name	Meaning	Data type	Flags	Default
1A01:0	AI TxPDO-Map Compact Ch.1	PDO Mapping TxPDO 2	UINT8	RO	0x01 (1 _{dec})
1A01:01	SubIndex 001	1. PDO Mapping entry (object 0x6000 (AI Inputs), entry 0x11 (Value))	UINT32	RO	0x6000:11, 16

Index 1C00 Sync manager type

Index (hex)	Name	Meaning	Data type	Flags	Default
1C00:0	Sync manager type	Using the sync managers	UINT8	RO	0x04 (4 _{dec})
1C00:01	SubIndex 001	Sync-Manager Type Channel 1: Mailbox Write	UINT8	RO	0x01 (1 _{dec})
1C00:02	SubIndex 002	Sync-Manager Type Channel 2: Mailbox Read	UINT8	RO	0x02 (2 _{dec})
1C00:03	SubIndex 003	Sync-Manager Type Channel 3: Process Data Write (Outputs)	UINT8	RO	0x03 (3 _{dec})
1C00:04	SubIndex 004	Sync-Manager Type Channel 4: Process Data Read (Inputs)	UINT8	RO	0x04 (4 _{dec})

Index 1C12 RxPDO assign

Index (hex)	Name	Meaning	Data type	Flags	Default
1C12:0	RxPDO assign	PDO Assign Outputs	UINT8	RW	0x00 (0 _{dec})

Index 1C13 TxPDO assign

For operation on masters other than TwinCAT it must be ensured that the channels are entered in the PDO assignment ("TxPDO assign", object 0x1C13) successively.

Index (hex)	Name	Meaning	Data type	Flags	Default
1C13:0	TxPDO assign	PDO Assign Inputs	UINT8	RW	0x01 (1 _{dec})
1C13:01	SubIndex 001	1. zugeordnete TxPDO (enthält den Index des zugehörigen TxPDO Mapping Objekts)	UINT16	RW	0x1A00 (6656 _{dec})

Index 1C33 SM input parameter

Index (hex)	Name	Meaning	Data type	Flags	Default
1C33:0	SM input parameter	Synchronization parameters for the inputs	UINT8	RO	0x20 (32 _{dec})
1C33:01	Sync mode	Current synchronization mode: <ul style="list-style-type: none"> • Bit 0 = 0: Free Run • Bit 0 = 1: Synchron with SM 2 Event • Bit 15 = 0: Standard • Bit 15 = 1: FastOp mode (CoE deactivated) 	UINT16	RW	0x0000 (0 _{dec})
1C33:02	Cycle time	Cycle time (in ns): <ul style="list-style-type: none"> • Free Run: Cycle time of the local timer • Synchronous with SM 2 event: Master cycle time • DC-Mode: SYNC0/SYNC1 Cycle Time 	UINT32	RW	0x000F4240 (1000000 _{dec})
1C33:03	Shift time	Time between SYNC0 event and reading of the inputs (in ns, only DC mode)	UINT32	RO	0x00000000 (0 _{dec})
1C33:04	Sync modes supported	Supported synchronization modes: <ul style="list-style-type: none"> • Bit 0: free run is supported • Bit 1: synchronous with SM 2 event is supported (outputs available) • Bit 1: synchronous with SM 3 event is supported (no outputs available) • Bit 2-3 = 01: DC mode is supported • Bit 4-5 = 01: input shift through local event (outputs available) • Bit 4-5 = 10: input shift with SYNC1 event (no outputs available) • Bit 14 = 1: dynamic times (measurement through writing of 0x1C33:08) 	UINT16	RO	0xC003 (49155 _{dec})
1C33:05	Minimum cycle time	Minimum cycle time (in ns)	UINT32	RO	0x0000FDE8 (65000 _{dec})
1C33:06	Calc and copy time	Time between reading of the inputs and availability of the inputs for the master (in ns, only DC mode)	UINT32	RO	0x00000000 (0 _{dec})
1C33:07	Minimum delay time		UINT32	RO	0x00000000 (0 _{dec})
1C33:08	Get cycle time	With this entry the real required process data provision time can be measured. <ul style="list-style-type: none"> • 0: Measurement of the local cycle time is stopped • 1: Measurement of the local cycle time is started The entries 0x1C33:03, 0x1C33:06, 1C33:09 are updated with the maximum measured values. For a subsequent measurement the measured values are reset.	UINT16	RW	0x0000 (0 _{dec})
1C33:09	Maximum delay time	Time between SYNC1 event and reading of the inputs (in ns, only DC mode)	UINT32	RO	0x00000000 (0 _{dec})
1C33:0B	SM event missed counter	Number of missed SM events in OPERATIONAL (DC mode only)	UINT16	RO	0x0000 (0 _{dec})
1C33:0C	Cycle exceeded counter	Number of occasions the cycle time was exceeded in OPERATIONAL (cycle was not completed in time or the next cycle began too early)	UINT16	RO	0x0000 (0 _{dec})
1C33:0D	Shift too short counter	Number of occasions that the interval between SYNC0 and SYNC1 event was too short (DC mode only)	UINT16	RO	0x0000 (0 _{dec})
1C33:20	Sync error	The synchronization was not correct in the last cycle (outputs were output too late; DC mode only)	BOOLEAN	RO	0x00 (0 _{dec})

5.6.1.2 EL3102

5.6.1.2.1 Restore object

Index 1011 Restore default parameters

Index (hex)	Name	Meaning	Data type	Flags	Default
1011:0	Restore default parameters ▶ 503	Restore default parameters	UINT8	RO	0x01 (1 _{dec})
1011:01	SubIndex 001	If this object is set to "0x64616F6C" in the set value dialog, all backup objects are reset to their delivery state.	UINT32	RW	0x00000000 (0 _{dec})

5.6.1.2.2 Configuration data

Index 40n0* producer code word (for n = 4 [channel 1], n = 8 [channel 2])



Producer code word

The vendor reserves the authority for the basic calibration of the terminals. The Producer code word is therefore at present reserved.

*) up to rev. no. EL31x2-0000-0016, only for EL31x2, see [note regarding EL31x2 terminals before rev. no. EL31x2-0000-0016](#) [▶ 278](#)

Index 40n1 ADC raw value (for n = 4 [channel 1], n = 8 [channel 2])

(up to rev. no. EL31x2-0000-0016, only for EL31x2, see [note](#) [▶ 278](#))

Index (hex)	Name	Meaning	Flags	Default
40n1:0	ADC raw value	Length of this object	RO	1 _{dec}
40n1:01	ADC rawdata	This is the circuit's raw ADC value. It is converted to a measurement through a calculation with the gain and offset from the calibration.	RO	-

Index 40n1 feature bits (for n = 6 [channel 1], n = A [channel 2])

(up to rev. no. EL31x2-0000-0016, only for EL31x2, see [note](#) [▶ 278](#))

Index (hex)	Name	Meaning	Flags	Default	
40n1:0	Feature bits	Length of this object	RW	3 _{dec}	
40n1:01	Enable user scale	TRUE	User scaling (index 40n2 ▶ 287) is active.	RW	FALSE
		FALSE	The user scaling is deactivated.		
40n1:02	Enable absolute with MSB as sign	TRUE	The measured value is output in magnitude-sign format.	RW	FALSE
			EL3102		
		EL3142-0010	+10 mA = 0x7FFF -10 mA = 0xFFFF		
		FALSE	The measured value is output as signed integer in the two's complement		
EL3142-0010	+10 mA = 0x7FFF -10 mA = 0x8001				
40n1:03	Enable filter	TRUE	The digital filter (index 40n5 ▶ 287), filter settings) is active. The analog values are not converted synchronously with the exchange of process data, but in accordance with the filter setting.	RW	FALSE
		FALSE	The analog values are converted synchronously with the exchange of process data; a digital filter is not active.		

Index 40n2 calibration data (for n = 4 [channel 1], n = 8 [channel 2])

(up to rev. no. EL31x2-0000-0016, only for EL31x2, see [note](#) [▶ 278](#))

Index (hex)	Name	Meaning	Flags	Default
40n2:0	Calibration data	Length of this object	RW	2 _{dec}
40n2:01	Offset 16 bit signed integer	These objects are used to trim the tolerances of the components to determine the measured value. The values can only be changed if the producer code word is set (index 40n0 [▶ 286]).	Offset trim channel 1/ channel 2	0xXXXX
40n2:02	Gain 16 bit unsigned integer		Gain trim channel 1/ channel 2	0xXXXX

**Index 40n2 user scale (for n = 4 [channel 1], n = A [channel 2])
(Feature bit 40n1:01 enabled) 40n1:01 [▶ 286]**

(up to rev. no. EL31x2-0000-0016, only for EL31x2, see note [▶ 278])

Index (hex)	Name	Meaning	Flags	Default
40n2:0	User scale	Length of this object	RW	2 _{dec}
40n2:01	Offset 16 bit signed integer	These objects contain the user scaling.	Offset trim, user scaling channel 1/ channel 2	0x0000
40n2:02	Gain 32 bit signed integer	The scaling is enabled via 40n1:01 [▶ 286].	Gain trim, user scaling channel 1/ channel 2 The gain is represented in fixed-point format, with the factor 2 ⁻¹⁶ . A value of 1 for the gain factor therefore corresponds to 65536 _{dec} (0x00010000).	0x00010000

**Index 40n5 filter settings (for n = 4 [channel 1], n = A [channel 2])
(Feature bit 40n1:03 enabled) 40n1:03 [▶ 286]**

(up to rev. no. EL31x2-0000-0016, only for EL31x2, see note [▶ 278])

Enum value	Decimal value	Description	Default
50 Hz FIR	0	50 Hz FIR over 32 values; 50 Hz interferences are suppressed with 60 dB	50 Hz FIR (0 _{dec})
60 Hz FIR	1	60 Hz FIR over 32 values; 60 Hz interferences are suppressed with 40 dB	
IIR Level 1	2	Recursive filter, t _{rise_90%} ** = 0.72 ms	
IIR Level 2	3	Recursive filter, t _{rise_90%} = 1.62 ms	
IIR Level 3	4	Recursive filter, t _{rise_90%} = 3.24 ms	
IIR Level 4	5	Recursive filter, t _{rise_90%} = 6.48 ms	
IIR Level 5	6	Recursive filter, t _{rise_90%} = 12.96 ms	
IIR Level 6	7	Recursive filter, t _{rise_90%} = 25.92 ms	
IIR Level 7	8	Recursive filter, t _{rise_90%} = 51.84 ms	
IIR Level 8	9	Recursive filter, t _{rise_90%} = 103.68 ms	

**) step in rise time [t_{rise_90%}]

Index 80n0*** AI settings (for $0 \leq n \leq 1$)

Index (hex)	Name	Meaning	Data type	Flags	Default
80n0:0	AI Settings	Maximum subindex	UINT8	RO	0x18 (24 _{dec})
80n0:01	Enable user scale [▶ 269]	User scale is active.	BOOLEAN	RW	0x00 (0 _{dec})
80n0:02	Presentation [▶ 244]	0: Signed presentation 1: Unsigned presentation 2: Absolute value with MSB as sign Signed amount representation	BIT3	RW	0x00 (0 _{dec})
80n0:05	Siemens bits [▶ 246]	The S5 bits are displayed in the three low-order bits	BOOLEAN	RW	0x00 (0 _{dec})
80n0:06	Enable filter	Enable filter, which makes PLC-cycle-synchronous data exchange unnecessary	BOOLEAN	RW	0x00 (0 _{dec})
80n0:07	Enable limit 1 [▶ 246]	Limit 1 enabled	BOOLEAN	RW	0x00 (0 _{dec})
80n0:08	Enable limit 2 [▶ 246]	Limit 2 enabled	BOOLEAN	RW	0x00 (0 _{dec})
80n0:0A	Enable user calibration [▶ 269]	Enabling of the user calibration	BOOLEAN	RW	0x00 (0 _{dec})
80n0:0B	Enable vendor calibration [▶ 269]	Enabling of the vendor calibration	BOOLEAN	RW	0x01 (1 _{dec})
80n0:0E	Swap limit bits [▶ 247]	Changing of the Limit Bits	BOOLEAN	RW	0x00 (0 _{dec})
80n0:11	User scale offset [▶ 269]	User scaling offset	INT16	RW	0x0000 (0 _{dec})
80n0:12	User scale gain [▶ 269]	User scaling gain. The gain is represented in fixed-point format, with the factor 2^{-16} . The value 1 corresponds to 65536 _{dec} (0x00010000) and is limited to $\pm 0x7FFFF$	INT32	RW	0x00010000 (65536 _{dec})
80n0:13	Limit 1 [▶ 246]	First limit value for setting the status bits	INT16	RW	0x0000 (0 _{dec})
80n0:14	Limit 2 [▶ 246]	Second limit value for setting the status bits	INT16	RW	0x0000 (0 _{dec})
80n0:15	Filter settings	This object determines the digital filter settings, if it is active via Enable filter (index 0x80n0:06 [▶ 288]). The possible settings are sequentially numbered. 0: 50 Hz FIR 1: 60 Hz FIR 2: IIR 1 3: IIR 2 4: IIR 3 5: IIR 4 6: IIR 5 7: IIR 6 8: IIR 7 9: IIR 8	UINT16	RW	0x0000 (0 _{dec})
80n0:17	User calibration offset [▶ 269]	User offset compensation	INT16	RW	0x0000 (0 _{dec})
80n0:18	User calibration gain [▶ 269]	User calibration gain	INT16	RW	0x4000 (16384 _{dec})

***) since revision no. EL31xx-00xx-0016



The filter characteristics are set via index **0x8000:15 [▶ 288]**

The filter frequencies are set for all channels of the EL31xx terminals centrally via index **0x8000:15 [▶ 288]** (channel 1). All other corresponding indices 0x80n0:15 have no parameterization function!

5.6.1.2.3 Profile-specific objects (0x6000-0xFFFF)

The profile-specific objects have the same meaning for all EtherCAT slaves that support the profile 5001.

5.6.1.2.3.1 Input data

Index 3101 inputs (channel 1)

(up to rev. no. EL31x2-0000-0016, only for EL31x2, see [note \[► 278\]](#))

Index (hex)	Name	Meaning	Flags	Default
3101:0	Inputs	Length of this object	RO	2 _{dec}
3101:01	Status	Status byte [► 254] channel 1	RO	-
3101:02	Value	Input process data channel 1	RO	-

Index 3102 inputs (channel 2)

(up to rev. no. EL31x2-0000-0016, only for EL31x2, see [note \[► 278\]](#))

Index (hex)	Name	Meaning	Flags	Default
3102:0	Inputs	Length of this object	RO	2 _{dec}
3102:01	Status	Status byte [► 254] channel 2	RO	-
3102:02	Value	Input process data channel 2	RO	-

Index 60n0*** AI inputs (for 0 ≤ n ≤ 1)

Index (hex)	Name	Meaning	Data type	Flags	Default
60n0:0	AI inputs	Maximum subindex	INT16	RO	0x11 (17 _{dec})
60n0:01	Underrange	Value below measuring range.	BOOLEAN	RO	0x00 (0 _{dec})
60n0:02	Overrange	Measuring range exceeded.	BOOLEAN	RO	0x00 (0 _{dec})
60n0:03	Limit 1	Limit value monitoring Limit 1 0: not active 1: value is smaller than limit value 1 2: value is larger than limit value 1 3: Value is equal to limit value 1	BIT2	RO	0x00 (0 _{dec})
60n0:05	Limit 2	Limit value monitoring limit 2 0: not active 1: value is smaller than limit value 2 2: value is larger than limit value 2 3: Value is equal to limit value 2	BIT2	RO	0x00 (0 _{dec})
60n0:07	Error	The error bit is set if the data is invalid (over-range, under-range)	BOOLEAN	RO	0x00 (0 _{dec})
60n0:0E	Sync error	The Sync error bit is only required for DC mode. It indicates whether a synchronization error has occurred during the previous cycle. This means a SYNC signal was triggered in the EL31xx, although no new process data were available (0=OK, 1=NOK).	BOOLEAN	RO	0x00 (0 _{dec})
60n0:0F	TxPDO State	Validity of the data of the associated TxPDO (0 = valid, 1 = invalid).	BOOLEAN	RO	0x00 (0 _{dec})
60n0:10	TxPDO Toggle	The TxPDO toggle is toggled by the slave when the data of the associated TxPDO is updated.	BOOLEAN	RO	0x00 (0 _{dec})
60n0:11	Value	Analog input date	INT16	RO	0x0000 (0 _{dec})

***) since revision no. EL31xx-00xx-0016

Index 6401 inputs (channels 1 & 2)

(up to rev. no. EL31x2-0000-0016, only for EL31x2, see [note \[► 278\]](#))

Index (hex)	Name	Meaning	Flags	Default
6401:0	Inputs	Length of this object	RO	2 _{dec}
6401:01	Value channel 1	Input process data channel 1	RO	-
6401:02	Value channel 2	Input process data channel 2	RO	-

5.6.1.2.3.2 Configuration data (vendor-specific)

Index 80nF*** AI vendor data (for $0 \leq n \leq 1$)

Index (hex)	Name	Meaning	Data type	Flags	Default
80nF:0	AI vendor data	Maximum subindex	UINT8	RO	0x02 (2 _{dec})
80nF:01	Calibration offset	Offset (vendor calibration)	INT16	RW	0x0000 (0 _{dec})
80nF:02	Calibration gain	Gain (vendor calibration)	INT16	RW	0x4000 (16384 _{dec})

***) since revision no. EL31xx-00xx-0016

5.6.1.2.3.3 Information and diagnostic data

Index 80nE*** AI internal data (for $0 \leq n \leq 1$)

Index (hex)	Name	Meaning	Data type	Flags	Default
80nE:0	AI internal data	Maximum subindex	UINT8	RO	0x01 (1 _{dec})
80nE:01	ADC raw value	ADC raw value	UINT16	RO	-

***) since revision no. EL31xx-00xx-0016

Index F000*** Modular device profile

Index (hex)	Name	Meaning	Data type	Flags	Default
F000:0	Modular device profile	General information for the modular device profile	UINT8	RO	0x02 (2 _{dec})
F000:01	Module index distance	Index spacing of the objects of the individual channels	UINT16	RO	0x0010 (16 _{dec})
F000:02	Maximum number of modules	Number of channels	UINT16	RO	<i>Max. Channels number of the terminal</i>

***) since revision no. EL31xx-00xx-0016

Index F008*** Code word

Index	Name	Meaning	Data type	Flags	Default
F008:0	Code word	reserved	UINT32	RW	0x00000000 (0 _{dec})

***) since revision no. EL31xx-00xx-0016

Index F009*** Password protection

Index (hex)	Name	Meaning	Data type	Flags	Default
F009:0	Password protection	Password protection user calibration [► 259]	UINT32	RW	0x00000000 (0 _{dec})

***) for EL31xx, see [note \[► 259\]](#)

Index F010*** module list (for $1 \leq n \leq 4$, depends on number of channels)

Index (hex)	Name	Meaning	Data type	Flags	Default
F010:0	Module list	Maximum subindex	UINT8	RW	0x0n
F010:0n	SubIndex 00n	Analog input profile (300)	UINT32	RW	0x0000012C (300 _{dec})

***) since revision no. EL31xx-00xx-0016

5.6.1.2.4 Standard objects

Standard objects (0x1000-0x1FFF)

The standard objects have the same meaning for all EtherCAT slaves.

Index 1000 Device type

Index (hex)	Name	Meaning	Data type	Flags	Default
1000:0	Device type	Device type of the EtherCAT slave: the Lo-Word contains the CoE profile used (5001). The Hi-Word contains the module profile according to the modular device profile.	UINT32	RO	0x00001389 (5001 _{dec})

Index 1008 Device name

Index (hex)	Name	Meaning	Data type	Flags	Default
1008:0	Device name	Device name of the EtherCAT slave	STRING	RO	EL31xx

Index 1009 Hardware version

Index (hex)	Name	Meaning	Data type	Flags	Default
1009:0	Hardware version	Hardware version of the EtherCAT slave	STRING	RO	00

Index 100A Software version

Index (hex)	Name	Meaning	Data type	Flags	Default
100A:0	Software version	Firmware version of the EtherCAT slave	STRING	RO	-

Index 1018 Identity

Index (hex)	Name	Meaning	Data type	Flags	Default
1018:0	Identity	Information for identifying the slave	UINT8	RO	0x04 (4 _{dec})
1018:01	Vendor ID	Vendor ID of the EtherCAT slave	UINT32	RO	0x00000002 (2 _{dec})
1018:02	Product code	Product code of the EtherCAT slave	UINT32	RO	0xFFFF3052
1018:03	Revision	Revision number of the EtherCAT slave; the low word (bit 0-15) indicates the special terminal number, the high word (bit 16-31) refers to the device description	UINT32	RO	-
1018:04	Serial number	Serial number of the EtherCAT slave; the low byte (bit 0-7) of the low word contains the year of production, the high byte (bit 8-15) of the low word contains the week of production, the high word (bit 16-31) is 0	UINT32	RO	-

Index 10F0*** Backup parameter handling

Index (hex)	Name	Meaning	Data type	Flags	Default
10F0:0	Backup parameter handling	Information for standardized loading and saving of backup entries	UINT8	RO	0x01 (1 _{dec})
10F0:01	Checksum	Checksum across all backup entries of the EtherCAT slave	UINT32	RO	-

***) since revision no. EL31xx-00xx-0016

Index 1800 TxPDO-Par Ch.1

Index (hex)	Name	Meaning	Data type	Flags	Default
1800:0	TxPDO-Par Ch.1	PDO Parameter TxPDO	UINT8	RO	0x06 (6 _{dec})
1800:06	Exclude TxPDOs	Hier sind die TxPDOs (Index der TxPDO Mapping Objekte) angegeben, die nicht zusammen mit TxPDO 1 übertragen werden dürfen	OCTET-STRING[2]	RO	02 1A 03 1A 07 1A 10 1A

Index 1801 TxPDO-Par Ch.2

Index (hex)	Name	Meaning	Data type	Flags	Default
1801:0	TxPDO-Par Ch.2	PDO Parameter TxPDO	UINT8	RO	0x06 (6 _{dec})
1801:06	Exclude TxPDOs	Hier sind die TxPDOs (Index der TxPDO Mapping Objekte) angegeben, die nicht zusammen mit TxPDO 2 übertragen werden dürfen	OCTET-STRING[2]	RO	04 1A 05 1A 09 1A 10 1A

Index 1802 AI TxPDO-Par Standard Ch.1

Index (hex)	Name	Meaning	Data type	Flags	Default
1802:0	AI TxPDO-Par Standard Ch.1	PDO Parameter TxPDO	UINT8	RO	0x06 (6 _{dec})
1802:06	Exclude TxPDOs	Hier sind die TxPDOs (Index der TxPDO Mapping Objekte) angegeben, die nicht zusammen mit TxPDO 1 übertragen werden dürfen	OCTET-STRING[2]	RO	01 1A 03 1A 07 1A 10 1A

Index 1803 AI TxPDO-Par Compact Ch.1

Index (hex)	Name	Meaning	Data type	Flags	Default
1803:0	AI TxPDO-Par Compact Ch.1	PDO Parameter TxPDO	UINT8	RO	0x06 (6 _{dec})
1803:06	Exclude TxPDOs	Hier sind die TxPDOs (Index der TxPDO Mapping Objekte) angegeben, die nicht zusammen mit TxPDO 2 übertragen werden dürfen	OCTET-STRING[2]	RO	00 1A 02 1A 07 1A 10 1A

Index 1804 AI TxPDO-Par Standard Ch.2

Index (hex)	Name	Meaning	Data type	Flags	Default
1804:0	AI TxPDO-Par Standard Ch.2	PDO Parameter TxPDO	UINT8	RO	0x06 (6 _{dec})
1804:06	Exclude TxPDOs	Hier sind die TxPDOs (Index der TxPDO Mapping Objekte) angegeben, die nicht zusammen mit TxPDO 3 übertragen werden dürfen	OCTET-STRING[2]	RO	00 1A 05 1A 09 1A 10 1A

Index 1805 AI TxPDO-Par Compact Ch.2

Index (hex)	Name	Meaning	Data type	Flags	Default
1805:0	AI TxPDO-Par Compact Ch.2	PDO Parameter TxPDO	UINT8	RO	0x06 (6 _{dec})
1805:06	Exclude TxPDOs	Hier sind die TxPDOs (Index der TxPDO Mapping Objekte) angegeben, die nicht zusammen mit TxPDO 4 übertragen werden dürfen	OCTET-STRING[2]	RO	00 1A 04 1A 09 1A 10 1A

Index 1807 AI TxPDO-Par DINT Ch.1

Index (hex)	Name	Meaning	Data type	Flags	Default
1807:0	AI TxPDO-Par DINT Ch.1	PDO Parameter TxPDO	UINT8	RO	0x06 (6 _{dec})
1807:06	Exclude TxPDOs	Hier sind die TxPDOs (Index der TxPDO Mapping Objekte) angegeben, die nicht zusammen mit TxPDO 1 übertragen werden dürfen	OCTET-STRING[2]	RO	00 1A 20 1A 30 1A 10 1A

Index 1809 AI TxPDO-Par DINT Ch.2

Index (hex)	Name	Meaning	Data type	Flags	Default
1809:0	AI TxPDO-Par DINT Ch.2	PDO Parameter TxPDO	UINT8	RO	0x06 (6 _{dec})
1809:06	Exclude TxPDOs	Hier sind die TxPDOs (Index der TxPDO Mapping Objekte) angegeben, die nicht zusammen mit TxPDO 2 übertragen werden dürfen	OCTET-STRING[2]	RO	10 1A 40 1A 50 1A 10 1A

Index 1810 TxPDO-Par Channels

Index (hex)	Name	Meaning	Data type	Flags	Default
1810:0	TxPDO-Par Channels	PDO Parameter TxPDO	UINT8	RO	0x06 (6 _{dec})
1810:06	Exclude TxPDOs	Hier sind die TxPDOs (Index der TxPDO Mapping Objekte) angegeben, die nicht zusammen mit TxPDO 1 übertragen werden dürfen	OCTET-STRING[2]	RO	00 1A 01 1A 02 1A 03 1A 04 1A 05 1A 07 1A 09 1A

Index 1A00 TxPDO-Par Channel 1 (only for EL31x2)

Index (hex)	Name	Meaning	Data type	Flags	Default
1A0n:0	TxPDO Map Ch. 1	PDO Mapping TxPDO Ch. 1	UINT8	RO	0x02 (2 _{dec})
1A00:01	SubIndex 001	1. PDO Mapping entry (object 0x3101 (Inputs), entry 0x01 (Inputs))	UINT32	RO	0x3101:01, 1
1A00:02	SubIndex 002	2. PDO Mapping entry (object 0x3101 (Inputs), entry 0x02 (Inputs))	UINT32	RO	0x3101:02, 1

Index 1A01 TxPDO-Par Channel 2 (only for EL31x2)

Index (hex)	Name	Meaning	Data type	Flags	Default
1A01:0	TxPDO Map Ch. 1	PDO Mapping TxPDO Ch. 1	UINT8	RO	0x02 (2 _{dec})
1A01:01	SubIndex 001	1. PDO Mapping entry (object 0x3102 (Inputs), entry 0x01 (Inputs))	UINT32	RO	0x3102:01, 1
1A01:02	SubIndex 002	2. PDO Mapping entry (object 0x3102 (Inputs), entry 0x02 (Inputs))	UINT32	RO	0x3102:02, 1

Index 1A02 AI TxPDO-Map Standard Ch.1

Index (hex)	Name	Meaning	Data type	Flags	Default
1A02:0	AI TxPDO-Map Standard Ch.1	PDO Mapping TxPDO	UINT8	RO	0x0B (11 _{dec})
1A02:01	SubIndex 001	1. PDO Mapping entry (object 0x6000 (AI Inputs), entry 0x01 (Underrange))	UINT32	RO	0x6000:01, 1
1A02:02	SubIndex 002	2. PDO Mapping entry (object 0x6000 (AI Inputs), entry 0x02 (Overrange))	UINT32	RO	0x6000:02, 1
1A02:03	SubIndex 003	3. PDO Mapping entry (object 0x6000 (AI Inputs), entry 0x03 (Limit 1))	UINT32	RO	0x6000:03, 2
1A02:04	SubIndex 004	4. PDO Mapping entry (object 0x6000 (AI Inputs), entry 0x05 (Limit 2))	UINT32	RO	0x6000:05, 2
1A02:05	SubIndex 005	5. PDO Mapping entry (object 0x6000 (AI Inputs), entry 0x07 (Error))	UINT32	RO	0x6000:07, 1
1A02:06	SubIndex 006	6. PDO Mapping entry (1 bit align)	UINT32	RO	0x0000:00, 1
1A02:07	SubIndex 007	7. PDO Mapping entry (5 bits align)	UINT32	RO	0x0000:00, 5
1A02:08	SubIndex 008	8. PDO Mapping entry (object 0x6000 (AI Inputs), entry 0x0E (Sync Error))	UINT32	RO	0x6000:0E, 1
1A02:09	SubIndex 009	9. PDO Mapping entry (object 0x6000 (AI Inputs), entry 0x0F (TxPDO State))	UINT32	RO	0x6000:0F, 1
1A02:0A	SubIndex 010	10. PDO Mapping entry (object 0x6000 (AI Inputs), entry 0x10 (TxPDO Toggle))	UINT32	RO	0x6000:10, 1
1A02:0B	SubIndex 011	11. PDO Mapping entry (object 0x6000 (AI Inputs), entry 0x11 (Value))	UINT32	RO	0x6000:11, 16

Index 1A03 AI TxPDO-Map Compact Ch.1

Index (hex)	Name	Meaning	Data type	Flags	Default
1A03:0	AI TxPDO-Map Compact Ch.1	PDO Mapping TxPDO	UINT8	RO	0x01 (1 _{dec})
1A03:01	SubIndex 001	1. PDO Mapping entry (object 0x6000 (AI Inputs), entry 0x11 (Value))	UINT32	RO	0x6000:11, 16

Index 1A04 AI TxPDO-Map Standard Ch.2

Index (hex)	Name	Meaning	Data type	Flags	Default
1A04:0	AI TxPDO-Map Standard Ch.2	PDO Mapping TxPDO	UINT8	RO	0x0B (11 _{dec})
1A04:01	SubIndex 001	1. PDO Mapping entry (object 0x6010 (AI Inputs), entry 0x01 (Underrange))	UINT32	RO	0x6010:01, 1
1A04:02	SubIndex 002	2. PDO Mapping entry (object 0x6010 (AI Inputs), entry 0x02 (Overrange))	UINT32	RO	0x6010:02, 1
1A04:03	SubIndex 003	3. PDO Mapping entry (object 0x6010 (AI Inputs), entry 0x03 (Limit 1))	UINT32	RO	0x6010:03, 2
1A04:04	SubIndex 004	4. PDO Mapping entry (object 0x6010 (AI Inputs), entry 0x05 (Limit 2))	UINT32	RO	0x6010:05, 2
1A04:05	SubIndex 005	5. PDO Mapping entry (object 0x6010 (AI Inputs), entry 0x07 (Error))	UINT32	RO	0x6010:07, 1
1A04:06	SubIndex 006	6. PDO Mapping entry (1 bit align)	UINT32	RO	0x0000:00, 1
1A04:07	SubIndex 007	7. PDO Mapping entry (5 bits align)	UINT32	RO	0x0000:00, 5
1A04:08	SubIndex 008	8. PDO Mapping entry (object 0x6010 (AI Inputs), entry 0x0E (Sync Error))	UINT32	RO	0x6010:0E, 1
1A04:09	SubIndex 009	9. PDO Mapping entry (object 0x6010 (AI Inputs), entry 0x0F (TxPDO State))	UINT32	RO	0x6010:0F, 1
1A04:0A	SubIndex 010	10. PDO Mapping entry (object 0x6010 (AI Inputs), entry 0x10 (TxPDO Toggle))	UINT32	RO	0x6010:10, 1
1A04:0B	SubIndex 011	11. PDO Mapping entry (object 0x6010 (AI Inputs), entry 0x11 (Value))	UINT32	RO	0x6010:11, 16

Index 1A05 AI TxPDO-Map Compact Ch.2

Index (hex)	Name	Meaning	Data type	Flags	Default
1A05:0	AI TxPDO-Map Compact Ch.2	PDO Mapping TxPDO	UINT8	RO	0x01 (1 _{dec})
1A05:01	SubIndex 001	1. PDO Mapping entry (object 0x6010 (AI Inputs), entry 0x11 (Value))	UINT32	RO	0x6010:11, 16

Index 1A07 AI TxPDO-Map DINT Ch.1

Index (hex)	Name	Meaning	Data type	Flags	Default
1A07:0	AI TxPDO-Map DINT Ch.1	PDO Mapping TxPDO	UINT8	RO	0x01 (1 _{dec})
1A07:01	SubIndex 001	1. PDO Mapping entry (object 0x6001 (AI Inputs), entry 0x11 (Value))	UINT32	RO	0x6030:11, 16

Index 1A09 AI TxPDO-Map DINT Ch.2

Index (hex)	Name	Meaning	Data type	Flags	Default
1A09:0	AI TxPDO-Map DINT Ch.2	PDO Mapping TxPDO	UINT8	RO	0x01 (1 _{dec})
1A09:01	SubIndex 001	1. PDO Mapping entry (object 0x6011 (AI Inputs), entry 0x11 (Value))	UINT32	RO	0x6011:11, 32

Index 1A10 TxPDO-Map Channels

Index (hex)	Name	Meaning	Data type	Flags	Default
1A10:0	TxPDO-Map Channels	PDO Mapping TxPDO	UINT8	RO	0x02 (2 _{dec})
1A10:01	SubIndex 001	1. PDO Mapping entry (object 0x3101 (Inputs), entry 0x01 (Inputs))	UINT32	RO	0x3101:02, 16
1A10:02	SubIndex 002	2. PDO Mapping entry (object 0x3101 (Inputs), entry 0x02 (Inputs))	UINT32	RO	0x3101:02, 16

Index 1C00 Sync manager type

Index (hex)	Name	Meaning	Data type	Flags	Default
1C00:0	Sync manager type	Using the sync managers	UINT8	RO	0x04 (4 _{dec})
1C00:01	SubIndex 001	Sync-Manager Type Channel 1: Mailbox Write	UINT8	RO	0x01 (1 _{dec})
1C00:02	SubIndex 002	Sync-Manager Type Channel 2: Mailbox Read	UINT8	RO	0x02 (2 _{dec})
1C00:03	SubIndex 003	Sync-Manager Type Channel 3: Process Data Write (Outputs)	UINT8	RO	0x03 (3 _{dec})
1C00:04	SubIndex 004	Sync-Manager Type Channel 4: Process Data Read (Inputs)	UINT8	RO	0x04 (4 _{dec})

Index 1C12 RxPDO assign

Index (hex)	Name	Meaning	Data type	Flags	Default
1C12:0	RxPDO assign	PDO Assign Outputs	UINT8	RW	0x00 (0 _{dec})

Index 1C13 TxPDO assign (only for EL31x2 before rev. EL31x2-0000-0016)

For operation on masters other than TwinCAT it must be ensured that the channels are entered in the PDO assignment ("TxPDO assign", object 0x1C13) successively.

Index (hex)	Name	Meaning	Data type	Flags	Default
1C13:0	TxPDO assign	PDO Assign Inputs	UINT8	RW	0x02 (2 _{dec})
1C13:01	SubIndex 001	1. allocated TxPDO (contains the index of the associated TxPDO mapping object)	UINT16	RW	0x1A02
1C13:02	SubIndex 002	2. allocated TxPDO (contains the index of the associated TxPDO mapping object)	UINT16	RW	0x1A04

Index 1C13 TxPDO assign (only for EL31x2 from rev. EL31x2-0000-0016)

For operation on masters other than TwinCAT it must be ensured that the channels are entered in the PDO assignment ("TxPDO assign", object 0x1C13) successively.

Index (hex)	Name	Meaning	Data type	Flags	Default
1C13:0	TxPDO assign	PDO Assign Inputs	UINT8	RW	0x02 (2 _{dec})
1C13:01	SubIndex 001	1. allocated TxPDO (contains the index of the associated TxPDO mapping object)	UINT16	RW	0x1A00
1C13:02	SubIndex 002	2. allocated TxPDO (contains the index of the associated TxPDO mapping object)	UINT16	RW	0x1A01

Index 1C33*** SM input parameter

Index (hex)	Name	Meaning	Data type	Flags	Default
1C33:0	SM input parameter	Synchronization parameters for the inputs	UINT8	RO	0x20 (32 _{dec})
1C33:01	Sync mode	Current synchronization mode: <ul style="list-style-type: none"> Bit 0 = 0: Free Run Bit 0 = 1: Synchronous with SM 3 event Bit 0-1 = 11: DC with SYNC1 event Bit 15 = 1: Fast mode 	UINT16	RW	0x0022 (34 _{dec})
1C33:02	Cycle time	Cycle time (in ns): <ul style="list-style-type: none"> Free Run: Cycle time of the local timer Synchronous with SM 2 event: Master cycle time DC mode: SYNC0/SYNC1 Cycle Time 	UINT32	RW	0x000F4240 (1000000 _{dec})
1C33:03	Shift time	Time between SYNC0 event and reading of the inputs (in ns, only DC mode)	UINT32	RO	0x000186A0 (100000 _{dec})
1C33:04	Sync modes supported	Supported synchronization modes: <ul style="list-style-type: none"> Bit 0 = 1: Free Run is supported Bit 1: Synchron with SM 3 Event is supported (no Outputs available) Bit 2 = 1: DC mode (SYNC0) Bit 3 = 1: DC mode (SYNC1) Bit 4-5 = 01: Input Shift with local event (Outputs available) Bit 4-5 = 10: Input Shift with SYNC1 Event (no Outputs available) Bit 12 = 1: Legacy Synchron Bit 13 = 1: SM event Bit 14 = 1: dynamic times (measure by writing 1C33:08 [▶ 296]) Bit 15 = 1: Fast mode 	UINT16	RO	0xD00B (53259 _{dec})
1C33:05	Minimum cycle time	Minimum cycle time (in ns)	UINT32	RO	0x000186A0 (100000 _{dec})
1C33:06	Calc and copy time	Time between reading of the inputs and availability of the inputs for the master (in ns, only DC mode)	UINT32	RO	0x00002710 (10000dez)
1C33:08	Command	With this entry the real required process data provision time can be measured. <ul style="list-style-type: none"> 0: Measurement of the local cycle time is stopped 1: Measurement of the local cycle time is started <p>The entries 1C33:03 [▶ 296], 1C33:06 [▶ 296], and 1C33:09 [▶ 296] are updated with the maximum measured values. For a subsequent measurement the measured values are reset</p>	UINT16	RW	0x0000 (0 _{dec})
1C33:09	Maximum Delay time	Time between SYNC1 event and reading of the inputs (in ns, only DC mode)	UINT32	RO	0x000186A0 (100000dez)
1C33:0B	SM event missed counter	Number of missed SM events in OPERATIONAL (DC mode only)	UINT16	RO	0x0000 (0 _{dec})
1C33:0C	Cycle exceeded counter	Number of occasions the cycle time was exceeded in OPERATIONAL (cycle was not completed in time or the next cycle began too early)	UINT16	RO	0x0000 (0 _{dec})
1C33:0D	Shift too short counter	Number of occasions that the interval between SYNC0 and SYNC1 event was too short (DC mode only)	UINT16	RO	0x0000 (0 _{dec})
1C33:20	Sync error	The synchronization was not correct in the last cycle (outputs were output too late; DC mode only)	BOOLEAN	RO	0x00 (0 _{dec})

***) since revision no. EL31xx-00xx-0016

5.6.1.3 EL3104

5.6.1.3.1 Restore object

Index 1011 Restore default parameters

Index (hex)	Name	Meaning	Data type	Flags	Default
1011:0	Restore default parameters [▶ 503]	Restore default parameters	UINT8	RO	0x01 (1 _{dec})
1011:01	SubIndex 001	If this object is set to “0x64616F6C” in the set value dialog, all backup objects are reset to their delivery state.	UINT32	RW	0x00000000 (0 _{dec})

5.6.1.3.2 Configuration data

Index 80n0*** AI settings (for 0 ≤ n ≤ 3)

Index (hex)	Name	Meaning	Data type	Flags	Default
80n0:0	AI Settings	Maximum subindex	UINT8	RO	0x18 (24 _{dec})
80n0:01	Enable user scale [▶ 269]	User scale is active.	BOOLEAN	RW	0x00 (0 _{dec})
80n0:02	Presentation [▶ 244]	0: Signed presentation 1: Unsigned presentation 2: Absolute value with MSB as sign Signed amount representation	BIT3	RW	0x00 (0 _{dec})
80n0:05	Siemens bits [▶ 246]	The S5 bits are displayed in the three low-order bits	BOOLEAN	RW	0x00 (0 _{dec})
80n0:06	Enable filter	Enable filter, which makes PLC-cycle-synchronous data exchange unnecessary	BOOLEAN	RW	0x00 (0 _{dec})
80n0:07	Enable limit 1 [▶ 246]	Limit 1 enabled	BOOLEAN	RW	0x00 (0 _{dec})
80n0:08	Enable limit 2 [▶ 246]	Limit 2 enabled	BOOLEAN	RW	0x00 (0 _{dec})
80n0:0A	Enable user calibration [▶ 269]	Enabling of the user calibration	BOOLEAN	RW	0x00 (0 _{dec})
80n0:0B	Enable vendor calibration [▶ 269]	Enabling of the vendor calibration	BOOLEAN	RW	0x01 (1 _{dec})
80n0:0E	Swap limit bits [▶ 247]	Changing of the Limit Bits	BOOLEAN	RW	0x00 (0 _{dec})
80n0:11	User scale offset [▶ 269]	User scaling offset	INT16	RW	0x0000 (0 _{dec})
80n0:12	User scale gain [▶ 269]	User scaling gain. The gain is represented in fixed-point format, with the factor 2 ⁻¹⁶ . The value 1 corresponds to 65536 _{dec} (0x00010000) and is limited to ±0x7FFFF	INT32	RW	0x00010000 (65536 _{dec})
80n0:13	Limit 1 [▶ 246]	First limit value for setting the status bits	INT16	RW	0x0000 (0 _{dec})
80n0:14	Limit 2 [▶ 246]	Second limit value for setting the status bits	INT16	RW	0x0000 (0 _{dec})
80n0:15	Filter settings	This object determines the digital filter settings, if it is active via Enable filter (index 0x80n0:06 [▶ 297]). The possible settings are sequentially numbered. 0: 50 Hz FIR 1: 60 Hz FIR 2: IIR 1 3: IIR 2 4: IIR 3 5: IIR 4 6: IIR 5 7: IIR 6 8: IIR 7 9: IIR 8	UINT16	RW	0x0000 (0 _{dec})
80n0:17	User calibration offset [▶ 269]	User offset compensation	INT16	RW	0x0000 (0 _{dec})
80n0:18	User calibration gain [▶ 269]	User calibration gain	INT16	RW	0x4000 (16384 _{dec})

***) since revision no. EL31xx-00xx-0016

Filter

The filters of the EL30xx/EL31xx are activated or deactivated via the CoE index 0x8000:15.

i The filter characteristics are set via index 0x8000:15

The filter frequencies are set for all channels of the EL30xx/EL31xx terminals centrally via index 0x8000:15 (channel 1). All other corresponding indices 0x80n0:15 have no parameterization function! The latest firmware version (see [status table](#) [▶ 484]) returns an EtherCAT-compliant error message, if the filter characteristics of other channels (index 0x80n0:06, 0x80n0:15) are set.

5.6.1.3.3 Profile-specific objects (0x6000-0xFFFF)

The profile-specific objects have the same meaning for all EtherCAT slaves that support the profile 5001.

5.6.1.3.3.1 Input data

Index 60n0*** AI inputs (for $0 \leq n \leq 3$)

Index (hex)	Name	Meaning	Data type	Flags	Default
60n0:0	AI inputs	Maximum subindex	INT16	RO	0x11 (17 _{dec})
60n0:01	Underrange	Value below measuring range.	BOOLEAN	RO	0x00 (0 _{dec})
60n0:02	Ovrange	Measuring range exceeded.	BOOLEAN	RO	0x00 (0 _{dec})
60n0:03	Limit 1	Limit value monitoring Limit 1 0: not active 1: value is smaller than limit value 1 2: value is larger than limit value 1 3: Value is equal to limit value 1	BIT2	RO	0x00 (0 _{dec})
60n0:05	Limit 2	Limit value monitoring limit 2 0: not active 1: value is smaller than limit value 2 2: value is larger than limit value 2 3: Value is equal to limit value 2	BIT2	RO	0x00 (0 _{dec})
60n0:07	Error	The error bit is set if the data is invalid (over-range, under-range)	BOOLEAN	RO	0x00 (0 _{dec})
60n0:0E	Sync error	The Sync error bit is only required for DC mode. It indicates whether a synchronization error has occurred during the previous cycle. This means a SYNC signal was triggered in the EL31xx, although no new process data were available (0=OK, 1=NOK).	BOOLEAN	RO	0x00 (0 _{dec})
60n0:0F	TxPDO State	Validity of the data of the associated TxPDO (0 = valid, 1 = invalid).	BOOLEAN	RO	0x00 (0 _{dec})
60n0:10	TxPDO Toggle	The TxPDO toggle is toggled by the slave when the data of the associated TxPDO is updated.	BOOLEAN	RO	0x00 (0 _{dec})
60n0:11	Value	Analog input date	INT16	RO	0x0000 (0 _{dec})

***) since revision no. EL31xx-00xx-0016

5.6.1.3.3.2 Configuration data (vendor-specific)

Index 80nF*** AI vendor data (for $0 \leq n \leq 3$)

Index (hex)	Name	Meaning	Data type	Flags	Default
80nF:0	AI vendor data	Maximum subindex	UINT8	RO	0x02 (2 _{dec})
80nF:01	Calibration offset	Offset (vendor calibration)	INT16	RW	0x0000 (0 _{dec})
80nF:02	Calibration gain	Gain (vendor calibration)	INT16	RW	0x4000 (16384 _{dec})

***) since revision no. EL31xx-00xx-0016

5.6.1.3.3 Information and diagnostic data

Index 80nE*** AI internal data (for $0 \leq n \leq 3$)

Index (hex)	Name	Meaning	Data type	Flags	Default
80nE:0	AI internal data	Maximum subindex	UINT8	RO	0x01 (1 _{dec})
80nE:01	ADC raw value	ADC raw value	UINT16	RO	-

***) since revision no. EL31xx-00xx-0016

Index F000*** Modular device profile

Index (hex)	Name	Meaning	Data type	Flags	Default
F000:0	Modular device profile	General information for the modular device profile	UINT8	RO	0x02 (2 _{dec})
F000:01	Module index distance	Index spacing of the objects of the individual channels	UINT16	RO	0x0010 (16 _{dec})
F000:02	Maximum number of modules	Number of channels	UINT16	RO	Max. Channels number of the terminal

***) since revision no. EL31xx-00xx-0016

Index F008*** Code word

Index	Name	Meaning	Data type	Flags	Default
F008:0	Code word	reserved	UINT32	RW	0x00000000 (0 _{dec})

***) since revision no. EL31xx-00xx-0016

Index F009*** Password protection

Index (hex)	Name	Meaning	Data type	Flags	Default
F009:0	Password protection	Password protection user calibration [▶ 259]	UINT32	RW	0x00000000 (0 _{dec})

***) for EL31xx, see [note \[\[▶ 259\]\(#\)\]](#)

Index F010*** module list (for $1 \leq n \leq 4$, depends on number of channels)

Index (hex)	Name	Meaning	Data type	Flags	Default
F010:0	Module list	Maximum subindex	UINT8	RW	0x0n
F010:0n	SubIndex 00n	Analog input profile (300)	UINT32	RW	0x0000012C (300 _{dec})

***) since revision no. EL31xx-00xx-0016

5.6.1.3.4 Standard objects

Standard objects (0x1000-0x1FFF)

The standard objects have the same meaning for all EtherCAT slaves.

Index 1000 Device type

Index (hex)	Name	Meaning	Data type	Flags	Default
1000:0	Device type	Device type of the EtherCAT slave: the Lo-Word contains the CoE profile used (5001). The Hi-Word contains the module profile according to the modular device profile.	UINT32	RO	0x012C1389 (19665801 _{dec})

Index 1008 Device name

Index (hex)	Name	Meaning	Data type	Flags	Default
1008:0	Device name	Device name of the EtherCAT slave	STRING	RO	EL31xx

Index 1009 Hardware version

Index (hex)	Name	Meaning	Data type	Flags	Default
1009:0	Hardware version	Hardware version of the EtherCAT slave	STRING	RO	00

Index 100A Software version

Index (hex)	Name	Meaning	Data type	Flags	Default
100A:0	Software version	Firmware version of the EtherCAT slave	STRING	RO	01

Index 1018 Identity

Index (hex)	Name	Meaning	Data type	Flags	Default
1018:0	Identity	Information for identifying the slave	UINT8	RO	0x04 (4 _{dec})
1018:01	Vendor ID	Vendor ID of the EtherCAT slave	UINT32	RO	0x00000002 (2 _{dec})
1018:02	Product code	Product code of the EtherCAT slave	UINT32	RO	0xFFFF3052
1018:03	Revision	Revision number of the EtherCAT slave; the low word (bit 0-15) indicates the special terminal number, the high word (bit 16-31) refers to the device description	UINT32	RO	-
1018:04	Serial number	Serial number of the EtherCAT slave; the low byte (bit 0-7) of the low word contains the year of production, the high byte (bit 8-15) of the low word contains the week of production, the high word (bit 16-31) is 0	UINT32	RO	-

Index 10F0 Backup parameter handling

Index (hex)	Name	Meaning	Data type	Flags	Default
10F0:0	Backup parameter handling	Information for standardised loading and saving of backup entries	UINT8	RO	0x01 (1 _{dec})
10F0:01	Checksum	Checksum across all backup entries of the EtherCAT slave	UINT32	RO	0x00000000 (0 _{dec})

Index 1800 AI TxPDO-Par Standard Ch.1

Index (hex)	Name	Meaning	Data type	Flags	Default
1800:0	AI TxPDO-Par Standard Ch.1	PDO parameter TxPDO 1	UINT8	RO	0x06 (6 _{dec})
1800:06	Exclude TxPDOs	Specifies the TxPDOs (index of TxPDO mapping objects) that must not be transferred together with TxPDO 1	OCTET-STRING[2]	RO	01 1A

Index 1801 AI TxPDO-Par Compact Ch.1

Index (hex)	Name	Meaning	Data type	Flags	Default
1801:0	AI TxPDO-Par Compact Ch.1	PDO parameter TxPDO 2	UINT8	RO	0x06 (6 _{dec})
1801:06	Exclude TxPDOs	Specifies the TxPDOs (index of TxPDO mapping objects) that must not be transferred together with TxPDO 2	OCTET-STRING[2]	RO	00 1A

Index 1802 AI TxPDO-Par Standard Ch.2

Index (hex)	Name	Meaning	Data type	Flags	Default
1802:0	AI TxPDO-Par Standard Ch.2	PDO parameter TxPDO 3	UINT8	RO	0x06 (6 _{dec})
1802:06	Exclude TxPDOs	Specifies the TxPDOs (index of TxPDO mapping objects) that must not be transferred together with TxPDO 3	OCTET-STRING[2]	RO	03 1A

Index 1803 AI TxPDO-Par Compact Ch. 2

Index (hex)	Name	Meaning	Data type	Flags	Default
1803:0	AI TxPDO-Par Compact Ch.2	PDO parameter TxPDO 4	UINT8	RO	0x06 (6 _{dec})
1803:06	Exclude TxPDOs	Specifies the TxPDOs (index of TxPDO mapping objects) that must not be transferred together with TxPDO 4	OCTET-STRING[2]	RO	02 1A

Index 1804 AI TxPDO-Par Standard Ch.3

Index (hex)	Name	Meaning	Data type	Flags	Default
1804:0	AI TxPDO-Par Standard Ch.3	PDO parameter TxPDO 5	UINT8	RO	0x06 (6 _{dec})
1804:06	Exclude TxPDOs	Specifies the TxPDOs (index of TxPDO mapping objects) that must not be transferred together with TxPDO 5	OCTET-STRING[2]	RO	05 1A

Index 1805 AI TxPDO-Par Compact Ch. 3

Index (hex)	Name	Meaning	Data type	Flags	Default
1805:0	AI TxPDO-Par Compact Ch.3	PDO parameter TxPDO 6	UINT8	RO	0x06 (6 _{dec})
1805:06	Exclude TxPDOs	Specifies the TxPDOs (index of TxPDO mapping objects) that must not be transferred together with TxPDO 6	OCTET-STRING[2]	RO	04 1A

Index 1806 AI TxPDO-Par Standard Ch.4

Index (hex)	Name	Meaning	Data type	Flags	Default
1806:0	AI TxPDO-Par Standard Ch.4	PDO parameter TxPDO 7	UINT8	RO	0x06 (6 _{dec})
1806:06	Exclude TxPDOs	Specifies the TxPDOs (index of TxPDO mapping objects) that must not be transferred together with TxPDO 7	OCTET-STRING[2]	RO	07 1A

Index 1807 AI TxPDO-Par Compact Ch. 4

Index (hex)	Name	Meaning	Data type	Flags	Default
1807:0	AI TxPDO-Par Compact Ch.4	PDO parameter TxPDO 8	UINT8	RO	0x06 (6 _{dec})
1807:06	Exclude TxPDOs	Specifies the TxPDOs (index of TxPDO mapping objects) that must not be transferred together with TxPDO 8	OCTET-STRING[2]	RO	06 1A

Index 1A00 AI TxPDO-Map Standard Ch.1

Index (hex)	Name	Meaning	Data type	Flags	Default
1A00:0	AI TxPDO-Map Standard Ch.1	PDO Mapping TxPDO	UINT8	RO	0x0B (11 _{dec})
1A00:01	SubIndex 001	1. PDO Mapping entry (object 0x6000 (AI Inputs), entry 0x01 (Underrange))	UINT32	RO	0x6000:01, 1
1A00:02	SubIndex 002	2. PDO Mapping entry (object 0x6000 (AI Inputs), entry 0x02 (Overrange))	UINT32	RO	0x6000:02, 1
1A00:03	SubIndex 003	3. PDO Mapping entry (object 0x6000 (AI Inputs), entry 0x03 (Limit 1))	UINT32	RO	0x6000:03, 2
1A00:04	SubIndex 004	4. PDO Mapping entry (object 0x6000 (AI Inputs), entry 0x05 (Limit 2))	UINT32	RO	0x6000:05, 2
1A00:05	SubIndex 005	5. PDO Mapping entry (object 0x6000 (AI Inputs), entry 0x07 (Error))	UINT32	RO	0x6000:07, 1
1A00:06	SubIndex 006	6. PDO Mapping entry (1 bit align)	UINT32	RO	0x0000:00, 1
1A00:07	SubIndex 007	7. PDO Mapping entry (5 bits align)	UINT32	RO	0x0000:00, 5
1A00:08	SubIndex 008	8. PDO Mapping entry (object 0x6000 (AI Inputs), entry 0x0E (Sync Error))	UINT32	RO	0x6000:0E, 1
1A00:09	SubIndex 009	9. PDO Mapping entry (object 0x6000 (AI Inputs), entry 0x0F (TxPDO State))	UINT32	RO	0x6000:0F, 1
1A00:0A	SubIndex 010	10. PDO Mapping entry (object 0x6000 (AI Inputs), entry 0x10 (TxPDO Toggle))	UINT32	RO	0x6000:10, 1
1A00:0B	SubIndex 011	11. PDO Mapping entry (object 0x6000 (AI Inputs), entry 0x11 (Value))	UINT32	RO	0x6000:11, 16

Index 1A01 AI TxPDO-Map Compact Ch.1

Index (hex)	Name	Meaning	Data type	Flags	Default
1A01:0	AI TxPDO-Map Compact Ch.1	PDO Mapping TxPDO 2	UINT8	RO	0x01 (1 _{dec})
1A01:01	SubIndex 001	1. PDO Mapping entry (object 0x6000 (AI Inputs), entry 0x11 (Value))	UINT32	RO	0x6000:11, 16

Index 1A02 AI TxPDO-Map Standard Ch.

Index (hex)	Name	Meaning	Data type	Flags	Default
1A02:0	AI TxPDO-Map Standard Ch.2	PDO Mapping TxPDO	UINT8	RO	0x0B (11 _{dec})
1A02:01	SubIndex 001	1. PDO Mapping entry (object 0x6010 (AI Inputs), entry 0x01 (Underrange))	UINT32	RO	0x6010:01, 1
1A02:02	SubIndex 002	2. PDO Mapping entry (object 0x6010 (AI Inputs), entry 0x02 (Overrange))	UINT32	RO	0x6010:02, 1
1A02:03	SubIndex 003	3. PDO Mapping entry (object 0x6010 (AI Inputs), entry 0x03 (Limit 1))	UINT32	RO	0x6010:03, 2
1A02:04	SubIndex 004	4. PDO Mapping entry (object 0x6010 (AI Inputs), entry 0x05 (Limit 2))	UINT32	RO	0x6010:05, 2
1A02:05	SubIndex 005	5. PDO Mapping entry (object 0x6010 (AI Inputs), entry 0x07 (Error))	UINT32	RO	0x6010:07, 1
1A02:06	SubIndex 006	6. PDO Mapping entry (1 bit align)	UINT32	RO	0x0000:00, 1
1A02:07	SubIndex 007	7. PDO Mapping entry (5 bits align)	UINT32	RO	0x0000:00, 5
1A02:08	SubIndex 008	8. PDO Mapping entry (object 0x6010 (AI Inputs), entry 0x0E (Sync Error))	UINT32	RO	0x6010:0E, 1
1A02:09	SubIndex 009	9. PDO Mapping entry (object 0x6010 (AI Inputs), entry 0x0F (TxPDO State))	UINT32	RO	0x6010:0F, 1
1A02:0A	SubIndex 010	10. PDO Mapping entry (object 0x6010 (AI Inputs), entry 0x10 (TxPDO Toggle))	UINT32	RO	0x6010:10, 1
1A02:0B	SubIndex 011	11. PDO Mapping entry (object 0x6010 (AI Inputs), entry 0x11 (Value))	UINT32	RO	0x6010:11, 16

Index 1A03 AI TxPDO-Map Compact Ch.2

Index (hex)	Name	Meaning	Data type	Flags	Default
1A03:0	AI TxPDO-Map Compact Ch.2	PDO Mapping TxPDO 4	UINT8	RO	0x01 (1 _{dec})
1A03:01	SubIndex 001	1. PDO Mapping entry (object 0x6010 (AI Inputs), entry 0x11 (Value))	UINT32	RO	0x6010:11, 16

Index 1A04 AI TxPDO-Map Standard Ch.3

Index (hex)	Name	Meaning	Data type	Flags	Default
1A04:0	AI TxPDO-Map Standard Ch.3	PDO Mapping TxPDO	UINT8	RO	0x0B (11 _{dec})
1A04:01	SubIndex 001	1. PDO Mapping entry (object 0x6020 (AI Inputs), entry 0x01 (Underrange))	UINT32	RO	0x6020:01, 1
1A04:02	SubIndex 002	2. PDO Mapping entry (object 0x6020 (AI Inputs), entry 0x02 (Overrange))	UINT32	RO	0x6020:02, 1
1A04:03	SubIndex 003	3. PDO Mapping entry (object 0x6020 (AI Inputs), entry 0x03 (Limit 1))	UINT32	RO	0x6020:03, 2
1A04:04	SubIndex 004	4. PDO Mapping entry (object 0x6020 (AI Inputs), entry 0x05 (Limit 2))	UINT32	RO	0x6020:05, 2
1A04:05	SubIndex 005	5. PDO Mapping entry (object 0x6020 (AI Inputs), entry 0x07 (Error))	UINT32	RO	0x6020:07, 1
1A04:06	SubIndex 006	6. PDO Mapping entry (1 bit align)	UINT32	RO	0x0000:00, 1
1A04:07	SubIndex 007	7. PDO Mapping entry (5 bits align)	UINT32	RO	0x0000:00, 5
1A04:08	SubIndex 008	8. PDO Mapping entry (object 0x6020 (AI Inputs), entry 0x0E (Sync Error))	UINT32	RO	0x6020:0E, 1
1A04:09	SubIndex 009	9. PDO Mapping entry (object 0x6020 (AI Inputs), entry 0x0F (TxPDO State))	UINT32	RO	0x6020:0F, 1
1A04:0A	SubIndex 010	10. PDO Mapping entry (object 0x6020 (AI Inputs), entry 0x10 (TxPDO Toggle))	UINT32	RO	0x6020:10, 1
1A04:0B	SubIndex 011	11. PDO Mapping entry (object 0x6020 (AI Inputs), entry 0x11 (Value))	UINT32	RO	0x6020:11, 16

Index 1A05 AI TxPDO-Map Compact Ch.3

Index (hex)	Name	Meaning	Data type	Flags	Default
1A05:0	AI TxPDO-Map Compact Ch.3	PDO Mapping TxPDO 6	UINT8	RO	0x01 (1 _{dec})
1A05:01	SubIndex 001	1. PDO Mapping entry (object 0x6020 (AI Inputs), entry 0x11 (Value))	UINT32	RO	0x6020:11, 16

Index 1A06 AI TxPDO-Map Standard Ch.4

Index (hex)	Name	Meaning	Data type	Flags	Default
1A06:0	AI TxPDO-Map Standard Ch.4	PDO Mapping TxPDO	UINT8	RO	0x0B (11 _{dec})
1A06:01	SubIndex 001	1. PDO Mapping entry (object 0x6030 (AI Inputs), entry 0x01 (Underrange))	UINT32	RO	0x6030:01, 1
1A06:02	SubIndex 002	2. PDO Mapping entry (object 0x6030 (AI Inputs), entry 0x02 (Overrange))	UINT32	RO	0x6030:02, 1
1A06:03	SubIndex 003	3. PDO Mapping entry (object 0x6030 (AI Inputs), entry 0x03 (Limit 1))	UINT32	RO	0x6030:03, 2
1A06:04	SubIndex 004	4. PDO Mapping entry (object 0x6030 (AI Inputs), entry 0x05 (Limit 2))	UINT32	RO	0x6030:05, 2
1A06:05	SubIndex 005	5. PDO Mapping entry (object 0x6030 (AI Inputs), entry 0x07 (Error))	UINT32	RO	0x6030:07, 1
1A06:06	SubIndex 006	6. PDO Mapping entry (1 bit align)	UINT32	RO	0x0000:00, 1
1A06:07	SubIndex 007	7. PDO Mapping entry (5 bits align)	UINT32	RO	0x0000:00, 5
1A06:08	SubIndex 008	8. PDO Mapping entry (object 0x6030 (AI Inputs), entry 0x0E (Sync Error))	UINT32	RO	0x6030:0E, 1
1A06:09	SubIndex 009	9. PDO Mapping entry (object 0x6030 (AI Inputs), entry 0x0F (TxPDO State))	UINT32	RO	0x6030:0F, 1
1A06:0A	SubIndex 010	10. PDO Mapping entry (object 0x6030 (AI Inputs), entry 0x10 (TxPDO Toggle))	UINT32	RO	0x6030:10, 1
1A06:0B	SubIndex 011	11. PDO Mapping entry (object 0x6030 (AI Inputs), entry 0x11 (Value))	UINT32	RO	0x6030:11, 16

Index 1A07 AI TxPDO-Map Compact Ch.4

Index (hex)	Name	Meaning	Data type	Flags	Default
1A07:0	AI TxPDO-Map Compact Ch.4	PDO Mapping TxPDO 8	UINT8	RO	0x01 (1 _{dec})
1A07:01	SubIndex 001	1. PDO Mapping entry (object 0x6030 (AI Inputs), entry 0x11 (Value))	UINT32	RO	0x6030:11, 16

Index 1C00 Sync manager type

Index (hex)	Name	Meaning	Data type	Flags	Default
1C00:0	Sync manager type	Using the sync managers	UINT8	RO	0x04 (4 _{dec})
1C00:01	SubIndex 001	Sync-Manager Type Channel 1: Mailbox Write	UINT8	RO	0x01 (1 _{dec})
1C00:02	SubIndex 002	Sync-Manager Type Channel 2: Mailbox Read	UINT8	RO	0x02 (2 _{dec})
1C00:03	SubIndex 003	Sync-Manager Type Channel 3: Process Data Write (Outputs)	UINT8	RO	0x03 (3 _{dec})
1C00:04	SubIndex 004	Sync-Manager Type Channel 4: Process Data Read (Inputs)	UINT8	RO	0x04 (4 _{dec})

Index 1C12 RxPDO assign

Index (hex)	Name	Meaning	Data type	Flags	Default
1C12:0	RxPDO assign	PDO Assign Outputs	UINT8	RW	0x00 (0 _{dec})

Index 1C13 TxPDO assign

For operation on masters other than TwinCAT it must be ensured that the channels are entered in the PDO assignment ("TxPDO assign", object 0x1C13) successively.

Index (hex)	Name	Meaning	Data type	Flags	Default
1C13:0	TxPDO assign	PDO Assign Inputs	UINT8	RW	0x04 (4 _{dec})
1C13:01	SubIndex 001	1. zugeordnete TxPDO (enthält den Index des zugehörigen TxPDO Mapping Objekts)	UINT16	RW	0x1A00 (6656 _{dec})
1C13:02	SubIndex 002	2. zugeordnete TxPDO (enthält den Index des zugehörigen TxPDO Mapping Objekts)	UINT16	RW	0x1A02 (6658 _{dec})
1C13:03	SubIndex 003	3. zugeordnete TxPDO (enthält den Index des zugehörigen TxPDO Mapping Objekts)	UINT16	RW	0x1A04 (6660 _{dec})
1C13:04	SubIndex 004	4. zugeordnete TxPDO (enthält den Index des zugehörigen TxPDO Mapping Objekts)	UINT16	RW	0x1A06 (6662 _{dec})

Index 1C33 SM input parameter

Index (hex)	Name	Meaning	Data type	Flags	Default
1C33:0	SM input parameter	Synchronization parameters for the inputs	UINT8	RO	0x20 (32 _{dec})
1C33:01	Sync mode	Current synchronization mode: <ul style="list-style-type: none"> • Bit 0 = 0: Free Run • Bit 0 = 1: Synchron with SM 2 Event • Bit 15 = 0: Standard • Bit 15 = 1: FastOp mode (CoE deactivated) 	UINT16	RW	0x0000 (0 _{dec})
1C33:02	Cycle time	Cycle time (in ns): <ul style="list-style-type: none"> • Free Run: Cycle time of the local timer • Synchronous with SM 2 event: Master cycle time • DC-Mode: SYNC0/SYNC1 Cycle Time 	UINT32	RW	0x000F4240 (1000000 _{dec})
1C33:03	Shift time	Time between SYNC0 event and reading of the inputs (in ns, only DC mode)	UINT32	RO	0x00000000 (0 _{dec})
1C33:04	Sync modes supported	Supported synchronization modes: <ul style="list-style-type: none"> • Bit 0: free run is supported • Bit 1: synchronous with SM 2 event is supported (outputs available) • Bit 1: synchronous with SM 3 event is supported (no outputs available) • Bit 2-3 = 01: DC mode is supported • Bit 4-5 = 01: input shift through local event (outputs available) • Bit 4-5 = 10: input shift with SYNC1 event (no outputs available) • Bit 14 = 1: dynamic times (measurement through writing of 0x1C33:08) 	UINT16	RO	0xC003 (49155 _{dec})
1C33:05	Minimum cycle time	Minimum cycle time (in ns)	UINT32	RO	0x0000FDE8 (65000 _{dec})
1C33:06	Calc and copy time	Time between reading of the inputs and availability of the inputs for the master (in ns, only DC mode)	UINT32	RO	0x00000000 (0 _{dec})
1C33:07	Minimum delay time		UINT32	RO	0x00000000 (0 _{dec})
1C33:08	Get cycle time	With this entry the real required process data provision time can be measured. <ul style="list-style-type: none"> • 0: Measurement of the local cycle time is stopped • 1: Measurement of the local cycle time is started The entries 0x1C33:03, 0x1C33:06, 1C33:09 are updated with the maximum measured values. For a subsequent measurement the measured values are reset.	UINT16	RW	0x0000 (0 _{dec})
1C33:09	Maximum delay time	Time between SYNC1 event and reading of the inputs (in ns, only DC mode)	UINT32	RO	0x00000000 (0 _{dec})
1C33:0B	SM event missed counter	Number of missed SM events in OPERATIONAL (DC mode only)	UINT16	RO	0x0000 (0 _{dec})
1C33:0C	Cycle exceeded counter	Number of occasions the cycle time was exceeded in OPERATIONAL (cycle was not completed in time or the next cycle began too early)	UINT16	RO	0x0000 (0 _{dec})
1C33:0D	Shift too short counter	Number of occasions that the interval between SYNC0 and SYNC1 event was too short (DC mode only)	UINT16	RO	0x0000 (0 _{dec})
1C33:20	Sync error	The synchronization was not correct in the last cycle (outputs were output too late; DC mode only)	BOOLEAN	RO	0x00 (0 _{dec})

5.6.2 EL311x

5.6.2.1 EL3111

5.6.2.1.1 Restore object

Index 1011 Restore default parameters

Index (hex)	Name	Meaning	Data type	Flags	Default
1011:0	Restore default parameters [►_503]	Restore default parameters	UINT8	RO	0x01 (1 _{dec})
1011:01	SubIndex 001	If this object is set to “ 0x64616F6C ” in the set value dialog, all backup objects are reset to their delivery state.	UINT32	RW	0x00000000 (0 _{dec})

5.6.2.1.2 Configuration data

Index 8000 AI settings

Index (hex)	Name	Meaning	Data type	Flags	Default
8000:0	AI Settings	Maximum subindex	UINT8	RO	0x18 (24 _{dec})
8000:01	Enable user scale [▶ 269]	User scale is active.	BOOLEAN	RW	0x00 (0 _{dec})
8000:02	Presentation [▶ 244]	0: Signed presentation 1: Unsigned presentation 2: Absolute value with MSB as sign Signed amount representation	BIT3	RW	0x00 (0 _{dec})
8000:05	Siemens bits [▶ 246]	The S5 bits are displayed in the three low-order bits	BOOLEAN	RW	0x00 (0 _{dec})
8000:06	Enable filter	Enable filter, which makes PLC-cycle-synchronous data exchange unnecessary	BOOLEAN	RW	0x00 (0 _{dec})
8000:07	Enable limit 1 [▶ 246]	Limit 1 enabled	BOOLEAN	RW	0x00 (0 _{dec})
8000:08	Enable limit 2 [▶ 246]	Limit 2 enabled	BOOLEAN	RW	0x00 (0 _{dec})
8000:0A	Enable user calibration [▶ 269]	Enabling of the user calibration	BOOLEAN	RW	0x00 (0 _{dec})
8000:0B	Enable vendor calibration [▶ 269]	Enabling of the vendor calibration	BOOLEAN	RW	0x01 (1 _{dec})
8000:0E	Swap limit bits [▶ 247]	Changing of the Limit Bits	BOOLEAN	RW	0x00 (0 _{dec})
80n0:11	User scale offset [▶ 269]	User scaling offset	INT16	RW	0x0000 (0 _{dec})
80n0:12	User scale gain [▶ 269]	User scaling gain. The gain is represented in fixed-point format, with the factor 2 ⁻¹⁶ . The value 1 corresponds to 65536 _{dec} (0x00010000) and is limited to ±0x7FFFF	INT32	RW	0x00010000 (65536 _{dec})
80n0:13	Limit 1 [▶ 246]	First limit value for setting the status bits	INT16	RW	0x0000 (0 _{dec})
80n0:14	Limit 2 [▶ 246]	Second limit value for setting the status bits	INT16	RW	0x0000 (0 _{dec})
80n0:15	Filter settings	This object determines the digital filter settings, if it is active via Enable filter (index 0x8000:06 [▶ 307]). The possible settings are sequentially numbered. 0: 50 Hz FIR 1: 60 Hz FIR 2: IIR 1 3: IIR 2 4: IIR 3 5: IIR 4 6: IIR 5 7: IIR 6 8: IIR 7 9: IIR 8	UINT16	RW	0x0000 (0 _{dec})
80n0:17	User calibration offset [▶ 269]	User offset compensation	INT16	RW	0x0000 (0 _{dec})
80n0:18	User calibration gain [▶ 269]	User calibration gain	INT16	RW	0x4000 (16384 _{dec})

***) since revision no. EL31xx-00xx-0016



The filter characteristics are set via index [0x8000:15](#) [\[▶ 307\]](#)

The filter frequencies are set for all channels of the EL31xx terminals centrally via index [0x8000:15](#) [\[▶ 307\]](#) (channel 1). All other corresponding indices 0x80n0:15 have no parameterization function!

5.6.2.1.3 Profile-specific objects (0x6000-0xFFFF)

The profile-specific objects have the same meaning for all EtherCAT slaves that support the profile 5001.

5.6.2.1.3.1 Input data

Index 6000 AI inputs

Index (hex)	Name	Meaning	Data type	Flags	Default
6000:0	AI inputs	Maximum subindex	INT16	RO	0x11 (17 _{dec})
6000:01	Underrange	Value below measuring range.	BOOLEAN	RO	0x00 (0 _{dec})
6000:02	Overrange	Measuring range exceeded.	BOOLEAN	RO	0x00 (0 _{dec})
6000:03	Limit 1	Limit value monitoring Limit 1 0: not active 1: value is smaller than limit value 1 2: value is larger than limit value 1 3: Value is equal to limit value 1	BIT2	RO	0x00 (0 _{dec})
6000:05	Limit 2	Limit value monitoring limit 2 0: not active 1: value is smaller than limit value 2 2: value is larger than limit value 2 3: Value is equal to limit value 2	BIT2	RO	0x00 (0 _{dec})
6000:07	Error	The error bit is set if the data is invalid (over-range, under-range)	BOOLEAN	RO	0x00 (0 _{dec})
6000:0E	Sync error	The Sync error bit is only required for DC mode. It indicates whether a synchronization error has occurred during the previous cycle. This means a SYNC signal was triggered in the EL31xx, although no new process data were available (0=OK, 1=NOK).	BOOLEAN	RO	0x00 (0 _{dec})
6000:0F	TxPDO State	Validity of the data of the associated TxPDO (0 = valid, 1 = invalid).	BOOLEAN	RO	0x00 (0 _{dec})
60n0:10	TxPDO Toggle	The TxPDO toggle is toggled by the slave when the data of the associated TxPDO is updated.	BOOLEAN	RO	0x00 (0 _{dec})
60n0:11	Value	Analog input date	INT16	RO	0x0000 (0 _{dec})

5.6.2.1.3.2 Configuration data (vendor-specific)

Index 800F AI vendor data

Index (hex)	Name	Meaning	Data type	Flags	Default
800F:0	AI vendor data	Maximum subindex	UINT8	RO	0x02 (2 _{dec})
800F:01	Calibration offset	Offset (vendor calibration)	INT16	RW	0x0000 (0 _{dec})
800F:02	Calibration gain	Gain (vendor calibration)	INT16	RW	0x4000 (16384 _{dec})

5.6.2.1.3.3 Information and diagnostic data

Index 800E AI internal data

Index (hex)	Name	Meaning	Data type	Flags	Default
800E:0	AI internal data	Maximum subindex	UINT8	RO	0x01 (1 _{dec})
800E:01	ADC raw value	ADC raw value	UINT16	RO	-

Index F000*** Modular device profile

Index (hex)	Name	Meaning	Data type	Flags	Default
F000:0	Modular device profile	General information for the modular device profile	UINT8	RO	0x02 (2 _{dec})
F000:01	Module index distance	Index spacing of the objects of the individual channels	UINT16	RO	0x0010 (16 _{dec})
F000:02	Maximum number of modules	Number of channels	UINT16	RO	<i>Max. Channels number of the terminal</i>

***) since revision no. EL31xx-00xx-0016

Index F008* Code word**

Index	Name	Meaning	Data type	Flags	Default
F008:0	Code word	reserved	UINT32	RW	0x00000000 (0 _{dec})

***) since revision no. EL31xx-00xx-0016

Index F009* Password protection**

Index (hex)	Name	Meaning	Data type	Flags	Default
F009:0	Password protection	Password protection user calibration [▶ 259]	UINT32	RW	0x00000000 (0 _{dec})

***) for EL31xx, see [note \[▶ 259\]](#)

Index F010* module list (for 1 ≤ n ≤ 4, depends on number of channels)**

Index (hex)	Name	Meaning	Data type	Flags	Default
F010:0	Module list	Maximum subindex	UINT8	RW	0x0n
F010:0n	SubIndex 00n	Analog input profile (300)	UINT32	RW	0x0000012C (300 _{dec})

***) since revision no. EL31xx-00xx-0016

5.6.2.1.4 Standard objects

Standard objects (0x1000-0x1FFF)

The standard objects have the same meaning for all EtherCAT slaves.

Index 1000 Device type

Index (hex)	Name	Meaning	Data type	Flags	Default
1000:0	Device type	Device type of the EtherCAT slave: the Lo-Word contains the CoE profile used (5001). The Hi-Word contains the module profile according to the modular device profile.	UINT32	RO	0x012C1389 (19665801 _{dec})

Index 1008 Device name

Index (hex)	Name	Meaning	Data type	Flags	Default
1008:0	Device name	Device name of the EtherCAT slave	STRING	RO	EL31xx

Index 1009 Hardware version

Index (hex)	Name	Meaning	Data type	Flags	Default
1009:0	Hardware version	Hardware version of the EtherCAT slave	STRING	RO	00

Index 100A Software version

Index (hex)	Name	Meaning	Data type	Flags	Default
100A:0	Software version	Firmware version of the EtherCAT slave	STRING	RO	-

Index 1018 Identity

Index (hex)	Name	Meaning	Data type	Flags	Default
1018:0	Identity	Information for identifying the slave	UINT8	RO	0x04 (4 _{dec})
1018:01	Vendor ID	Vendor ID of the EtherCAT slave	UINT32	RO	0x00000002 (2 _{dec})
1018:02	Product code	Product code of the EtherCAT slave	UINT32	RO	0xFFFF3052
1018:03	Revision	Revision number of the EtherCAT slave; the low word (bit 0-15) indicates the special terminal number, the high word (bit 16-31) refers to the device description	UINT32	RO	-
1018:04	Serial number	Serial number of the EtherCAT slave; the low byte (bit 0-7) of the low word contains the year of production, the high byte (bit 8-15) of the low word contains the week of production, the high word (bit 16-31) is 0	UINT32	RO	-

Index 10F0* Backup parameter handling**

Index (hex)	Name	Meaning	Data type	Flags	Default
10F0:0	Backup parameter handling	Information for standardized loading and saving of backup entries	UINT8	RO	0x01 (1 _{dec})
10F0:01	Checksum	Checksum across all backup entries of the EtherCAT slave	UINT32	RO	-

***) since revision no. EL31xx-00xx-0016

Index 1800 AI TxPDO-Par Standard Ch.1

Index (hex)	Name	Meaning	Data type	Flags	Default
1800:0	AI TxPDO-Par Standard Ch.1	PDO parameter TxPDO 1	UINT8	RO	0x06 (6 _{dec})
1800:06	Exclude TxPDOs	Specifies the TxPDOs (index of TxPDO mapping objects) that must not be transferred together with TxPDO 1	OCTET-STRING[2]	RO	01 1A

Index 1801 AI TxPDO-Par Compact Ch.1

Index (hex)	Name	Meaning	Data type	Flags	Default
1801:0	AI TxPDO-Par Compact Ch.1	PDO parameter TxPDO 2	UINT8	RO	0x06 (6 _{dec})
1801:06	Exclude TxPDOs	Specifies the TxPDOs (index of TxPDO mapping objects) that must not be transferred together with TxPDO 2	OCTET-STRING[2]	RO	00 1A

Index 1A00 AI TxPDO-Map Standard Ch.1

Index (hex)	Name	Meaning	Data type	Flags	Default
1A00:0	AI TxPDO-Map Standard Ch.1	PDO Mapping TxPDO	UINT8	RO	0x0B (11 _{dec})
1A00:01	SubIndex 001	1. PDO Mapping entry (object 0x6000 (AI Inputs), entry 0x01 (Underrange))	UINT32	RO	0x6000:01, 1
1A00:02	SubIndex 002	2. PDO Mapping entry (object 0x6000 (AI Inputs), entry 0x02 (Ovrange))	UINT32	RO	0x6000:02, 1
1A00:03	SubIndex 003	3. PDO Mapping entry (object 0x6000 (AI Inputs), entry 0x03 (Limit 1))	UINT32	RO	0x6000:03, 2
1A00:04	SubIndex 004	4. PDO Mapping entry (object 0x6000 (AI Inputs), entry 0x05 (Limit 2))	UINT32	RO	0x6000:05, 2
1A00:05	SubIndex 005	5. PDO Mapping entry (object 0x6000 (AI Inputs), entry 0x07 (Error))	UINT32	RO	0x6000:07, 1
1A00:06	SubIndex 006	6. PDO Mapping entry (1 bit align)	UINT32	RO	0x0000:00, 1
1A00:07	SubIndex 007	7. PDO Mapping entry (5 bits align)	UINT32	RO	0x0000:00, 5
1A00:08	SubIndex 008	8. PDO Mapping entry (object 0x6000 (AI Inputs), entry 0x0E (Sync Error))	UINT32	RO	0x6000:0E, 1
1A00:09	SubIndex 009	9. PDO Mapping entry (object 0x6000 (AI Inputs), entry 0x0F (TxPDO State))	UINT32	RO	0x6000:0F, 1
1A00:0A	SubIndex 010	10. PDO Mapping entry (object 0x6000 (AI Inputs), entry 0x10 (TxPDO Toggle))	UINT32	RO	0x6000:10, 1
1A00:0B	SubIndex 011	11. PDO Mapping entry (object 0x6000 (AI Inputs), entry 0x11 (Value))	UINT32	RO	0x6000:11, 16

Index 1A01 AI TxPDO-Map Compact Ch.1

Index (hex)	Name	Meaning	Data type	Flags	Default
1A01:0	AI TxPDO-Map Compact Ch.1	PDO Mapping TxPDO 2	UINT8	RO	0x01 (1 _{dec})
1A01:01	SubIndex 001	1. PDO Mapping entry (object 0x6000 (AI Inputs), entry 0x11 (Value))	UINT32	RO	0x6000:11, 16

Index 1C00 Sync manager type

Index (hex)	Name	Meaning	Data type	Flags	Default
1C00:0	Sync manager type	Using the sync managers	UINT8	RO	0x04 (4 _{dec})
1C00:01	SubIndex 001	Sync-Manager Type Channel 1: Mailbox Write	UINT8	RO	0x01 (1 _{dec})
1C00:02	SubIndex 002	Sync-Manager Type Channel 2: Mailbox Read	UINT8	RO	0x02 (2 _{dec})
1C00:03	SubIndex 003	Sync-Manager Type Channel 3: Process Data Write (Outputs)	UINT8	RO	0x03 (3 _{dec})
1C00:04	SubIndex 004	Sync-Manager Type Channel 4: Process Data Read (Inputs)	UINT8	RO	0x04 (4 _{dec})

Index 1C12 RxPDO assign

Index (hex)	Name	Meaning	Data type	Flags	Default
1C12:0	RxPDO assign	PDO Assign Outputs	UINT8	RW	0x00 (0 _{dec})

Index 1C13 TxPDO assign

For operation on masters other than TwinCAT it must be ensured that the channels are entered in the PDO assignment ("TxPDO assign", object 0x1C13) successively.

Index (hex)	Name	Meaning	Data type	Flags	Default
1C13:0	TxPDO assign	PDO Assign Inputs	UINT8	RW	0x01 (1 _{dec})
1C13:01	SubIndex 001	1. zugeordnete TxPDO (enthält den Index des zugehörigen TxPDO Mapping Objekts)	UINT16	RW	0x1A00 (6656 _{dec})

Index 1C33 SM input parameter

Index (hex)	Name	Meaning	Data type	Flags	Default
1C33:0	SM input parameter	Synchronization parameters for the inputs	UINT8	RO	0x20 (32 _{dec})
1C33:01	Sync mode	Current synchronization mode: <ul style="list-style-type: none"> Bit 0 = 0: Free Run Bit 0 = 1: Synchron with SM 2 Event Bit 15 = 0: Standard Bit 15 = 1: FastOp mode (CoE deactivated) 	UINT16	RW	0x0000 (0 _{dec})
1C33:02	Cycle time	Cycle time (in ns): <ul style="list-style-type: none"> Free Run: Cycle time of the local timer Synchronous with SM 2 event: Master cycle time DC-Mode: SYNC0/SYNC1 Cycle Time 	UINT32	RW	0x000F4240 (1000000 _{dec})
1C33:03	Shift time	Time between SYNC0 event and reading of the inputs (in ns, only DC mode)	UINT32	RO	0x00000000 (0 _{dec})
1C33:04	Sync modes supported	Supported synchronization modes: <ul style="list-style-type: none"> Bit 0: free run is supported Bit 1: synchronous with SM 2 event is supported (outputs available) Bit 1: synchronous with SM 3 event is supported (no outputs available) Bit 2-3 = 01: DC mode is supported Bit 4-5 = 01: input shift through local event (outputs available) Bit 4-5 = 10: input shift with SYNC1 event (no outputs available) Bit 14 = 1: dynamic times (measurement through writing of 0x1C33:08) 	UINT16	RO	0xC003 (49155 _{dec})
1C33:05	Minimum cycle time	Minimum cycle time (in ns)	UINT32	RO	0x0000FDE8 (65000 _{dec})
1C33:06	Calc and copy time	Time between reading of the inputs and availability of the inputs for the master (in ns, only DC mode)	UINT32	RO	0x00000000 (0 _{dec})
1C33:07	Minimum delay time		UINT32	RO	0x00000000 (0 _{dec})
1C33:08	Get cycle time	With this entry the real required process data provision time can be measured. <ul style="list-style-type: none"> 0: Measurement of the local cycle time is stopped 1: Measurement of the local cycle time is started The entries 0x1C33:03, 0x1C33:06, 1C33:09 are updated with the maximum measured values. For a subsequent measurement the measured values are reset.	UINT16	RW	0x0000 (0 _{dec})
1C33:09	Maximum delay time	Time between SYNC1 event and reading of the inputs (in ns, only DC mode)	UINT32	RO	0x00000000 (0 _{dec})
1C33:0B	SM event missed counter	Number of missed SM events in OPERATIONAL (DC mode only)	UINT16	RO	0x0000 (0 _{dec})
1C33:0C	Cycle exceeded counter	Number of occasions the cycle time was exceeded in OPERATIONAL (cycle was not completed in time or the next cycle began too early)	UINT16	RO	0x0000 (0 _{dec})
1C33:0D	Shift too short counter	Number of occasions that the interval between SYNC0 and SYNC1 event was too short (DC mode only)	UINT16	RO	0x0000 (0 _{dec})
1C33:20	Sync error	The synchronization was not correct in the last cycle (outputs were output too late; DC mode only)	BOOLEAN	RO	0x00 (0 _{dec})

5.6.2.2 EL3112

5.6.2.2.1 Restore object

Index 1011 Restore default parameters

Index (hex)	Name	Meaning	Data type	Flags	Default
1011:0	Restore default parameters ▶ 503	Restore default parameters	UINT8	RO	0x01 (1 _{dec})
1011:01	SubIndex 001	If this object is set to “0x64616F6C” in the set value dialog, all backup objects are reset to their delivery state.	UINT32	RW	0x00000000 (0 _{dec})

5.6.2.2.2 Configuration data

Index 40n0* producer code word (for n = 4 [channel 1], n = 8 [channel 2])

● Producer code word

i The vendor reserves the authority for the basic calibration of the terminals. The Producer code word is therefore at present reserved.

*) up to rev. no. EL31x2-0000-0016, only for EL31x2, see [note regarding EL31x2 terminals before rev. no. EL31x2-0000-0016 ▶ 278](#)

Index 40n1 ADC raw value (for n = 4 [channel 1], n = 8 [channel 2])

(up to rev. no. EL31x2-0000-0016, only for EL31x2, see [note ▶ 278](#))

Index (hex)	Name	Meaning	Flags	Default
40n1:0	ADC raw value	Length of this object	RO	1 _{dec}
40n1:01	ADC rawdata	This is the circuit's raw ADC value. It is converted to a measurement through a calculation with the gain and offset from the calibration.	RO	-

Index 40n1 feature bits (for n = 6 [channel 1], n = A [channel 2])

(up to rev. no. EL31x2-0000-0016, only for EL31x2, see [note ▶ 278](#))

Index (hex)	Name	Meaning	Flags	Default	
40n1:0	Feature bits	Length of this object	RW	3 _{dec}	
40n1:01	Enable user scale	TRUE	User scaling (index 40n2 ▶ 314) is active.	RW	FALSE
		FALSE	The user scaling is deactivated.		
40n1:02	Enable absolute with MSB as sign	TRUE	The measured value is output in magnitude-sign format.	RW	FALSE
			EL3102		
		EL3142-0010	+10 mA = 0x7FFF -10 mA = 0xFFFF		
		FALSE	The measured value is output as signed integer in the two's complement		
EL3142-0010	+10 mA = 0x7FFF -10 mA = 0x8001				
40n1:03	Enable filter	TRUE	The digital filter (index 40n5 ▶ 314 , filter settings) is active. The analog values are not converted synchronously with the exchange of process data, but in accordance with the filter setting.	RW	FALSE
		FALSE	The analog values are converted synchronously with the exchange of process data; a digital filter is not active.		

Index 40n2 calibration data (for n = 4 [channel 1], n = 8 [channel 2])

(up to rev. no. EL31x2-0000-0016, only for EL31x2, see [note ▶ 278](#))

Index (hex)	Name	Meaning	Flags	Default	
40n2:0	Calibration data	Length of this object	RW	2 _{dec}	
40n2:01	Offset 16 bit signed integer	These objects are used to trim the tolerances of the components to determine the measured value. The values can only be changed if the producer code word is set (index 40n0 [▶ 313]).	Offset trim channel 1/ channel 2	RW	0xXXXX
40n2:02	Gain 16 bit unsigned integer		Gain trim channel 1/ channel 2	RW	0xXXXX

**Index 40n2 user scale (for n = 4 [channel 1], n = A [channel 2])
(Feature bit 40n1:01 enabled) 40n1:01 [▶ 313]**

(up to rev. no. EL31x2-0000-0016, only for EL31x2, see note [▶ 278])

Index (hex)	Name	Meaning	Flags	Default	
40n2:0	User scale	Length of this object	RW	2 _{dec}	
40n2:01	Offset 16 bit signed integer	These objects contain the user scaling.	Offset trim, user scaling channel 1/ channel 2	RW	0x0000
40n2:02	Gain 32 bit signed integer	The scaling is enabled via 40n1:01 [▶ 313].	Gain trim, user scaling channel 1/ channel 2 The gain is represented in fixed-point format, with the factor 2 ⁻¹⁶ . A value of 1 for the gain factor therefore corresponds to 65536 _{dec} (0x00010000).	RW	0x00010000

**Index 40n5 filter settings (for n = 4 [channel 1], n = A [channel 2])
(Feature bit 40n1:03 enabled) 40n1:03 [▶ 313]**

(up to rev. no. EL31x2-0000-0016, only for EL31x2, see note [▶ 278])

Enum value	Decimal value	Description	Default
50 Hz FIR	0	50 Hz FIR over 32 values; 50 Hz interferences are suppressed with 60 dB	50 Hz FIR (0 _{dec})
60 Hz FIR	1	60 Hz FIR over 32 values; 60 Hz interferences are suppressed with 40 dB	
IIR Level 1	2	Recursive filter, t _{rise_90%} ** = 0.72 ms	
IIR Level 2	3	Recursive filter, t _{rise_90%} = 1.62 ms	
IIR Level 3	4	Recursive filter, t _{rise_90%} = 3.24 ms	
IIR Level 4	5	Recursive filter, t _{rise_90%} = 6.48 ms	
IIR Level 5	6	Recursive filter, t _{rise_90%} = 12.96 ms	
IIR Level 6	7	Recursive filter, t _{rise_90%} = 25.92 ms	
IIR Level 7	8	Recursive filter, t _{rise_90%} = 51.84 ms	
IIR Level 8	9	Recursive filter, t _{rise_90%} = 103.68 ms	

**) step in rise time [t_{rise_90%}]

Index 80n0*** AI settings (for $0 \leq n \leq 1$)

Index (hex)	Name	Meaning	Data type	Flags	Default
80n0:0	AI Settings	Maximum subindex	UINT8	RO	0x18 (24 _{dec})
80n0:01	Enable user scale [▶ 269]	User scale is active.	BOOLEAN	RW	0x00 (0 _{dec})
80n0:02	Presentation [▶ 244]	0: Signed presentation 1: Unsigned presentation 2: Absolute value with MSB as sign Signed amount representation	BIT3	RW	0x00 (0 _{dec})
80n0:05	Siemens bits [▶ 246]	The S5 bits are displayed in the three low-order bits	BOOLEAN	RW	0x00 (0 _{dec})
80n0:06	Enable filter	Enable filter, which makes PLC-cycle-synchronous data exchange unnecessary	BOOLEAN	RW	0x00 (0 _{dec})
80n0:07	Enable limit 1 [▶ 246]	Limit 1 enabled	BOOLEAN	RW	0x00 (0 _{dec})
80n0:08	Enable limit 2 [▶ 246]	Limit 2 enabled	BOOLEAN	RW	0x00 (0 _{dec})
80n0:0A	Enable user calibration [▶ 269]	Enabling of the user calibration	BOOLEAN	RW	0x00 (0 _{dec})
80n0:0B	Enable vendor calibration [▶ 269]	Enabling of the vendor calibration	BOOLEAN	RW	0x01 (1 _{dec})
80n0:0E	Swap limit bits [▶ 247]	Changing of the Limit Bits	BOOLEAN	RW	0x00 (0 _{dec})
80n0:11	User scale offset [▶ 269]	User scaling offset	INT16	RW	0x0000 (0 _{dec})
80n0:12	User scale gain [▶ 269]	User scaling gain. The gain is represented in fixed-point format, with the factor 2^{-16} . The value 1 corresponds to 65536 _{dec} (0x00010000) and is limited to $\pm 0x7FFFF$	INT32	RW	0x00010000 (65536 _{dec})
80n0:13	Limit 1 [▶ 246]	First limit value for setting the status bits	INT16	RW	0x0000 (0 _{dec})
80n0:14	Limit 2 [▶ 246]	Second limit value for setting the status bits	INT16	RW	0x0000 (0 _{dec})
80n0:15	Filter settings	This object determines the digital filter settings, if it is active via Enable filter (index 0x80n0:06 [▶ 315]). The possible settings are sequentially numbered. 0: 50 Hz FIR 1: 60 Hz FIR 2: IIR 1 3: IIR 2 4: IIR 3 5: IIR 4 6: IIR 5 7: IIR 6 8: IIR 7 9: IIR 8	UINT16	RW	0x0000 (0 _{dec})
80n0:17	User calibration offset [▶ 269]	User offset compensation	INT16	RW	0x0000 (0 _{dec})
80n0:18	User calibration gain [▶ 269]	User calibration gain	INT16	RW	0x4000 (16384 _{dec})

***) since revision no. EL31xx-00xx-0016



The filter characteristics are set via index 0x8000:15 [▶ 315]

The filter frequencies are set for all channels of the EL31xx terminals centrally via index 0x8000:15 [▶ 315] (channel 1). All other corresponding indices 0x80n0:15 have no parameterization function!

5.6.2.2.3 Profile-specific objects (0x6000-0xFFFF)

The profile-specific objects have the same meaning for all EtherCAT slaves that support the profile 5001.

5.6.2.2.3.1 Input data

Index 3101 inputs (channel 1)

(up to rev. no. EL31x2-0000-0016, only for EL31x2, see [note \[► 278\]](#))

Index (hex)	Name	Meaning	Flags	Default
3101:0	Inputs	Length of this object	RO	2 _{dec}
3101:01	Status	Status byte [► 254] channel 1	RO	-
3101:02	Value	Input process data channel 1	RO	-

Index 3102 inputs (channel 2)

(up to rev. no. EL31x2-0000-0016, only for EL31x2, see [note \[► 278\]](#))

Index (hex)	Name	Meaning	Flags	Default
3102:0	Inputs	Length of this object	RO	2 _{dec}
3102:01	Status	Status byte [► 254] channel 2	RO	-
3102:02	Value	Input process data channel 2	RO	-

Index 60n0*** AI inputs (for 0 ≤ n ≤ 1)

Index (hex)	Name	Meaning	Data type	Flags	Default
60n0:0	AI inputs	Maximum subindex	INT16	RO	0x11 (17 _{dec})
60n0:01	Underrange	Value below measuring range.	BOOLEAN	RO	0x00 (0 _{dec})
60n0:02	Overrange	Measuring range exceeded.	BOOLEAN	RO	0x00 (0 _{dec})
60n0:03	Limit 1	Limit value monitoring Limit 1 0: not active 1: value is smaller than limit value 1 2: value is larger than limit value 1 3: Value is equal to limit value 1	BIT2	RO	0x00 (0 _{dec})
60n0:05	Limit 2	Limit value monitoring limit 2 0: not active 1: value is smaller than limit value 2 2: value is larger than limit value 2 3: Value is equal to limit value 2	BIT2	RO	0x00 (0 _{dec})
60n0:07	Error	The error bit is set if the data is invalid (over-range, under-range)	BOOLEAN	RO	0x00 (0 _{dec})
60n0:0E	Sync error	The Sync error bit is only required for DC mode. It indicates whether a synchronization error has occurred during the previous cycle. This means a SYNC signal was triggered in the EL31xx, although no new process data were available (0=OK, 1=NOK).	BOOLEAN	RO	0x00 (0 _{dec})
60n0:0F	TxPDO State	Validity of the data of the associated TxPDO (0 = valid, 1 = invalid).	BOOLEAN	RO	0x00 (0 _{dec})
60n0:10	TxPDO Toggle	The TxPDO toggle is toggled by the slave when the data of the associated TxPDO is updated.	BOOLEAN	RO	0x00 (0 _{dec})
60n0:11	Value	Analog input date	INT16	RO	0x0000 (0 _{dec})

***) since revision no. EL31xx-00xx-0016

Index 6401 inputs (channels 1 & 2)

(up to rev. no. EL31x2-0000-0016, only for EL31x2, see [note \[► 278\]](#))

Index (hex)	Name	Meaning	Flags	Default
6401:0	Inputs	Length of this object	RO	2 _{dec}
6401:01	Value channel 1	Input process data channel 1	RO	-
6401:02	Value channel 2	Input process data channel 2	RO	-

5.6.2.2.3.2 Configuration data (vendor-specific)

Index 80nF*** AI vendor data (for $0 \leq n \leq 1$)

Index (hex)	Name	Meaning	Data type	Flags	Default
80nF:0	AI vendor data	Maximum subindex	UINT8	RO	0x02 (2 _{dec})
80nF:01	Calibration offset	Offset (vendor calibration)	INT16	RW	0x0000 (0 _{dec})
80nF:02	Calibration gain	Gain (vendor calibration)	INT16	RW	0x4000 (16384 _{dec})

***) since revision no. EL31xx-00xx-0016

5.6.2.2.3.3 Information and diagnostic data

Index 80nE*** AI internal data (for $0 \leq n \leq 1$)

Index (hex)	Name	Meaning	Data type	Flags	Default
80nE:0	AI internal data	Maximum subindex	UINT8	RO	0x01 (1 _{dec})
80nE:01	ADC raw value	ADC raw value	UINT16	RO	-

***) since revision no. EL31xx-00xx-0016

Index F000*** Modular device profile

Index (hex)	Name	Meaning	Data type	Flags	Default
F000:0	Modular device profile	General information for the modular device profile	UINT8	RO	0x02 (2 _{dec})
F000:01	Module index distance	Index spacing of the objects of the individual channels	UINT16	RO	0x0010 (16 _{dec})
F000:02	Maximum number of modules	Number of channels	UINT16	RO	Max. Channels number of the terminal

***) since revision no. EL31xx-00xx-0016

Index F008*** Code word

Index	Name	Meaning	Data type	Flags	Default
F008:0	Code word	reserved	UINT32	RW	0x00000000 (0 _{dec})

***) since revision no. EL31xx-00xx-0016

Index F009*** Password protection

Index (hex)	Name	Meaning	Data type	Flags	Default
F009:0	Password protection	Password protection user calibration [► 259]	UINT32	RW	0x00000000 (0 _{dec})

***) for EL31xx, see [note \[► 259\]](#)

Index F010*** module list (for $1 \leq n \leq 4$, depends on number of channels)

Index (hex)	Name	Meaning	Data type	Flags	Default
F010:0	Module list	Maximum subindex	UINT8	RW	0x0n
F010:0n	SubIndex 00n	Analog input profile (300)	UINT32	RW	0x0000012C (300 _{dec})

***) since revision no. EL31xx-00xx-0016

5.6.2.2.4 Standard objects

Standard objects (0x1000-0x1FFF)

The standard objects have the same meaning for all EtherCAT slaves.

Index 1000 Device type

Index (hex)	Name	Meaning	Data type	Flags	Default
1000:0	Device type	Device type of the EtherCAT slave: the Lo-Word contains the CoE profile used (5001). The Hi-Word contains the module profile according to the modular device profile.	UINT32	RO	0x00001389 (5001 _{dec})

Index 1008 Device name

Index (hex)	Name	Meaning	Data type	Flags	Default
1008:0	Device name	Device name of the EtherCAT slave	STRING	RO	EL31xx

Index 1009 Hardware version

Index (hex)	Name	Meaning	Data type	Flags	Default
1009:0	Hardware version	Hardware version of the EtherCAT slave	STRING	RO	00

Index 100A Software version

Index (hex)	Name	Meaning	Data type	Flags	Default
100A:0	Software version	Firmware version of the EtherCAT slave	STRING	RO	-

Index 1018 Identity

Index (hex)	Name	Meaning	Data type	Flags	Default
1018:0	Identity	Information for identifying the slave	UINT8	RO	0x04 (4 _{dec})
1018:01	Vendor ID	Vendor ID of the EtherCAT slave	UINT32	RO	0x00000002 (2 _{dec})
1018:02	Product code	Product code of the EtherCAT slave	UINT32	RO	0xFFFF3052
1018:03	Revision	Revision number of the EtherCAT slave; the low word (bit 0-15) indicates the special terminal number, the high word (bit 16-31) refers to the device description	UINT32	RO	-
1018:04	Serial number	Serial number of the EtherCAT slave; the low byte (bit 0-7) of the low word contains the year of production, the high byte (bit 8-15) of the low word contains the week of production, the high word (bit 16-31) is 0	UINT32	RO	-

Index 10F0*** Backup parameter handling

Index (hex)	Name	Meaning	Data type	Flags	Default
10F0:0	Backup parameter handling	Information for standardized loading and saving of backup entries	UINT8	RO	0x01 (1 _{dec})
10F0:01	Checksum	Checksum across all backup entries of the EtherCAT slave	UINT32	RO	-

***) since revision no. EL31xx-00xx-0016

Index 1800 TxPDO-Par Ch.1

Index (hex)	Name	Meaning	Data type	Flags	Default
1800:0	TxPDO-Par Ch.1	PDO Parameter TxPDO	UINT8	RO	0x06 (6 _{dec})
1800:06	Exclude TxPDOs	Hier sind die TxPDOs (Index der TxPDO Mapping Objekte) angegeben, die nicht zusammen mit TxPDO 1 übertragen werden dürfen	OCTET-STRING[2]	RO	02 1A 03 1A 07 1A 10 1A

Index 1801 TxPDO-Par Ch.2

Index (hex)	Name	Meaning	Data type	Flags	Default
1801:0	TxPDO-Par Ch.2	PDO Parameter TxPDO	UINT8	RO	0x06 (6 _{dec})
1801:06	Exclude TxPDOs	Hier sind die TxPDOs (Index der TxPDO Mapping Objekte) angegeben, die nicht zusammen mit TxPDO 2 übertragen werden dürfen	OCTET-STRING[2]	RO	04 1A 05 1A 09 1A 10 1A

Index 1802 AI TxPDO-Par Standard Ch.2

Index (hex)	Name	Meaning	Data type	Flags	Default
1802:0	AI TxPDO-Par Standard Ch.2	PDO parameter TxPDO 3	UINT8	RO	0x06 (6 _{dec})
1802:06	Exclude TxPDOs	Specifies the TxPDOs (index of TxPDO mapping objects) that must not be transferred together with TxPDO 3	OCTET-STRING[2]	RO	03 1A

Index 1803 AI TxPDO-Par Compact Ch.1

Index (hex)	Name	Meaning	Data type	Flags	Default
1803:0	AI TxPDO-Par Compact Ch.1	PDO Parameter TxPDO	UINT8	RO	0x06 (6 _{dec})
1803:06	Exclude TxPDOs	Hier sind die TxPDOs (Index der TxPDO Mapping Objekte) angegeben, die nicht zusammen mit TxPDO 2 übertragen werden dürfen	OCTET-STRING[2]	RO	00 1A 02 1A 07 1A 10 1A

Index 1804 AI TxPDO-Par Standard Ch.2

Index (hex)	Name	Meaning	Data type	Flags	Default
1804:0	AI TxPDO-Par Standard Ch.2	PDO Parameter TxPDO	UINT8	RO	0x06 (6 _{dec})
1804:06	Exclude TxPDOs	Hier sind die TxPDOs (Index der TxPDO Mapping Objekte) angegeben, die nicht zusammen mit TxPDO 3 übertragen werden dürfen	OCTET-STRING[2]	RO	00 1A 05 1A 09 1A 10 1A

Index 1805 AI TxPDO-Par Compact Ch.2

Index (hex)	Name	Meaning	Data type	Flags	Default
1805:0	AI TxPDO-Par Compact Ch.2	PDO Parameter TxPDO	UINT8	RO	0x06 (6 _{dec})
1805:06	Exclude TxPDOs	Hier sind die TxPDOs (Index der TxPDO Mapping Objekte) angegeben, die nicht zusammen mit TxPDO 4 übertragen werden dürfen	OCTET-STRING[2]	RO	00 1A 04 1A 09 1A 10 1A

Index 1810 TxPDO-Par Channels

Index (hex)	Name	Meaning	Data type	Flags	Default
1810:0	TxPDO-Par Channels	PDO Parameter TxPDO	UINT8	RO	0x06 (6 _{dec})
1810:06	Exclude TxPDOs	Hier sind die TxPDOs (Index der TxPDO Mapping Objekte) angegeben, die nicht zusammen mit TxPDO 1 übertragen werden dürfen	OCTET-STRING[2]	RO	00 1A 01 1A 02 1A 03 1A 04 1A 05 1A 07 1A 09 1A

Index 1A00 TxPDO-Par Channel 1 (only for EL31x2)

Index (hex)	Name	Meaning	Data type	Flags	Default
1A0n:0	TxPDO Map Ch. 1	PDO Mapping TxPDO Ch. 1	UINT8	RO	0x02 (2 _{dec})
1A00:01	SubIndex 001	1. PDO Mapping entry (object 0x3101 (Inputs), entry 0x01 (Inputs))	UINT32	RO	0x3101:01, 1
1A00:02	SubIndex 002	2. PDO Mapping entry (object 0x3101 (Inputs), entry 0x02 (Inputs))	UINT32	RO	0x3101:02, 1

Index 1A01 TxPDO-Par Channel 2 (only for EL31x2)

Index (hex)	Name	Meaning	Data type	Flags	Default
1A01:0	TxPDO Map Ch. 1	PDO Mapping TxPDO Ch. 1	UINT8	RO	0x02 (2 _{dec})
1A01:01	SubIndex 001	1. PDO Mapping entry (object 0x3102 (Inputs), entry 0x01 (Inputs))	UINT32	RO	0x3102:01, 1
1A01:02	SubIndex 002	2. PDO Mapping entry (object 0x3102 (Inputs), entry 0x02 (Inputs))	UINT32	RO	0x3102:02, 1

Index 1A02 AI TxPDO-Map Standard Ch.1

Index (hex)	Name	Meaning	Data type	Flags	Default
1A02:0	AI TxPDO-Map Standard Ch.1	PDO Mapping TxPDO	UINT8	RO	0x0B (11 _{dec})
1A02:01	SubIndex 001	1. PDO Mapping entry (object 0x6000 (AI Inputs), entry 0x01 (Underrange))	UINT32	RO	0x6000:01, 1
1A02:02	SubIndex 002	2. PDO Mapping entry (object 0x6000 (AI Inputs), entry 0x02 (Overrange))	UINT32	RO	0x6000:02, 1
1A02:03	SubIndex 003	3. PDO Mapping entry (object 0x6000 (AI Inputs), entry 0x03 (Limit 1))	UINT32	RO	0x6000:03, 2
1A02:04	SubIndex 004	4. PDO Mapping entry (object 0x6000 (AI Inputs), entry 0x05 (Limit 2))	UINT32	RO	0x6000:05, 2
1A02:05	SubIndex 005	5. PDO Mapping entry (object 0x6000 (AI Inputs), entry 0x07 (Error))	UINT32	RO	0x6000:07, 1
1A02:06	SubIndex 006	6. PDO Mapping entry (1 bit align)	UINT32	RO	0x0000:00, 1
1A02:07	SubIndex 007	7. PDO Mapping entry (5 bits align)	UINT32	RO	0x0000:00, 5
1A02:08	SubIndex 008	8. PDO Mapping entry (object 0x6000 (AI Inputs), entry 0x0E (Sync Error))	UINT32	RO	0x6000:0E, 1
1A02:09	SubIndex 009	9. PDO Mapping entry (object 0x6000 (AI Inputs), entry 0x0F (TxPDO State))	UINT32	RO	0x6000:0F, 1
1A02:0A	SubIndex 010	10. PDO Mapping entry (object 0x6000 (AI Inputs), entry 0x10 (TxPDO Toggle))	UINT32	RO	0x6000:10, 1
1A02:0B	SubIndex 011	11. PDO Mapping entry (object 0x6000 (AI Inputs), entry 0x11 (Value))	UINT32	RO	0x6000:11, 16

Index 1A03 AI TxPDO-Map Compact Ch.1

Index (hex)	Name	Meaning	Data type	Flags	Default
1A03:0	AI TxPDO-Map Compact Ch.1	PDO Mapping TxPDO	UINT8	RO	0x01 (1 _{dec})
1A03:01	SubIndex 001	1. PDO Mapping entry (object 0x6000 (AI Inputs), entry 0x11 (Value))	UINT32	RO	0x6000:11, 16

Index 1A04 AI TxPDO-Map Standard Ch.2

Index (hex)	Name	Meaning	Data type	Flags	Default
1A04:0	AI TxPDO-Map Standard Ch.2	PDO Mapping TxPDO	UINT8	RO	0x0B (1 _{dec})
1A04:01	SubIndex 001	1. PDO Mapping entry (object 0x6010 (AI Inputs), entry 0x01 (Underrange))	UINT32	RO	0x6010:01, 1
1A04:02	SubIndex 002	2. PDO Mapping entry (object 0x6010 (AI Inputs), entry 0x02 (Overrange))	UINT32	RO	0x6010:02, 1
1A04:03	SubIndex 003	3. PDO Mapping entry (object 0x6010 (AI Inputs), entry 0x03 (Limit 1))	UINT32	RO	0x6010:03, 2
1A04:04	SubIndex 004	4. PDO Mapping entry (object 0x6010 (AI Inputs), entry 0x05 (Limit 2))	UINT32	RO	0x6010:05, 2
1A04:05	SubIndex 005	5. PDO Mapping entry (object 0x6010 (AI Inputs), entry 0x07 (Error))	UINT32	RO	0x6010:07, 1
1A04:06	SubIndex 006	6. PDO Mapping entry (1 bit align)	UINT32	RO	0x0000:00, 1
1A04:07	SubIndex 007	7. PDO Mapping entry (5 bits align)	UINT32	RO	0x0000:00, 5
1A04:08	SubIndex 008	8. PDO Mapping entry (object 0x6010 (AI Inputs), entry 0x0E (Sync Error))	UINT32	RO	0x6010:0E, 1
1A04:09	SubIndex 009	9. PDO Mapping entry (object 0x6010 (AI Inputs), entry 0x0F (TxPDO State))	UINT32	RO	0x6010:0F, 1
1A04:0A	SubIndex 010	10. PDO Mapping entry (object 0x6010 (AI Inputs), entry 0x10 (TxPDO Toggle))	UINT32	RO	0x6010:10, 1
1A04:0B	SubIndex 011	11. PDO Mapping entry (object 0x6010 (AI Inputs), entry 0x11 (Value))	UINT32	RO	0x6010:11, 16

Index 1A05 AI TxPDO-Map Compact Ch.2

Index (hex)	Name	Meaning	Data type	Flags	Default
1A05:0	AI TxPDO-Map Compact Ch.2	PDO Mapping TxPDO	UINT8	RO	0x01 (1 _{dec})
1A05:01	SubIndex 001	1. PDO Mapping entry (object 0x6010 (AI Inputs), entry 0x11 (Value))	UINT32	RO	0x6010:11, 16

Index 1A10 TxPDO-Map Channels

Index (hex)	Name	Meaning	Data type	Flags	Default
1A10:0	TxPDO-Map Channels	PDO Mapping TxPDO	UINT8	RO	0x02 (2 _{dec})
1A10:01	SubIndex 001	1. PDO Mapping entry (object 0x3101 (Inputs), entry 0x01 (Inputs))	UINT32	RO	0x3101:02, 16
1A10:02	SubIndex 002	2. PDO Mapping entry (object 0x3101 (Inputs), entry 0x02 (Inputs))	UINT32	RO	0x3101:02, 16

Index 1C00 Sync manager type

Index (hex)	Name	Meaning	Data type	Flags	Default
1C00:0	Sync manager type	Using the sync managers	UINT8	RO	0x04 (4 _{dec})
1C00:01	SubIndex 001	Sync-Manager Type Channel 1: Mailbox Write	UINT8	RO	0x01 (1 _{dec})
1C00:02	SubIndex 002	Sync-Manager Type Channel 2: Mailbox Read	UINT8	RO	0x02 (2 _{dec})
1C00:03	SubIndex 003	Sync-Manager Type Channel 3: Process Data Write (Outputs)	UINT8	RO	0x03 (3 _{dec})
1C00:04	SubIndex 004	Sync-Manager Type Channel 4: Process Data Read (Inputs)	UINT8	RO	0x04 (4 _{dec})

Index 1C12 RxPDO assign

Index (hex)	Name	Meaning	Data type	Flags	Default
1C12:0	RxPDO assign	PDO Assign Outputs	UINT8	RW	0x00 (0 _{dec})

Index 1C13 TxPDO assign (only for EL31x2 before rev. EL31x2-0000-0016)

For operation on masters other than TwinCAT it must be ensured that the channels are entered in the PDO assignment ("TxPDO assign", object 0x1C13) successively.

Index (hex)	Name	Meaning	Data type	Flags	Default
1C13:0	TxPDO assign	PDO Assign Inputs	UINT8	RW	0x02 (2 _{dec})
1C13:01	SubIndex 001	1. allocated TxPDO (contains the index of the associated TxPDO mapping object)	UINT16	RW	0x1A02
1C13:02	SubIndex 002	2. allocated TxPDO (contains the index of the associated TxPDO mapping object)	UINT16	RW	0x1A04

Index 1C13 TxPDO assign (only for EL31x2 from rev. EL31x2-0000-0016)

For operation on masters other than TwinCAT it must be ensured that the channels are entered in the PDO assignment ("TxPDO assign", object 0x1C13) successively.

Index (hex)	Name	Meaning	Data type	Flags	Default
1C13:0	TxPDO assign	PDO Assign Inputs	UINT8	RW	0x02 (2 _{dec})
1C13:01	SubIndex 001	1. allocated TxPDO (contains the index of the associated TxPDO mapping object)	UINT16	RW	0x1A00
1C13:02	SubIndex 002	2. allocated TxPDO (contains the index of the associated TxPDO mapping object)	UINT16	RW	0x1A01

Index 1C33* SM input parameter**

Index (hex)	Name	Meaning	Data type	Flags	Default
1C33:0	SM input parameter	Synchronization parameters for the inputs	UINT8	RO	0x20 (32 _{dec})
1C33:01	Sync mode	Current synchronization mode: <ul style="list-style-type: none"> • Bit 0 = 0: Free Run • Bit 0 = 1: Synchronous with SM 3 event • Bit 0-1 = 11: DC with SYNC1 event • Bit 15 = 1: Fast mode 	UINT16	RW	0x0022 (34 _{dec})
1C33:02	Cycle time	Cycle time (in ns): <ul style="list-style-type: none"> • Free Run: Cycle time of the local timer • Synchronous with SM 2 event: Master cycle time • DC mode: SYNC0/SYNC1 Cycle Time 	UINT32	RW	0x000F4240 (1000000 _{dec})
1C33:03	Shift time	Time between SYNC0 event and reading of the inputs (in ns, only DC mode)	UINT32	RO	0x000186A0 (100000 _{dec})
1C33:04	Sync modes supported	Supported synchronization modes: <ul style="list-style-type: none"> • Bit 0 = 1: Free Run is supported • Bit 1: Synchron with SM 3 Event is supported (no Outputs available) • Bit 2 = 1: DC mode (SYNC0) • Bit 3 = 1: DC mode (SYNC1) • Bit 4-5 = 01: Input Shift with local event (Outputs available) • Bit 4-5 = 10: Input Shift with SYNC1 Event (no Outputs available) • Bit 12 = 1: Legacy Synchron • Bit 13 = 1: SM event • Bit 14 = 1: dynamic times (measure by writing 1C33:08 [▶ 323]) • Bit 15 = 1: Fast mode 	UINT16	RO	0xD00B (53259 _{dec})
1C33:05	Minimum cycle time	Minimum cycle time (in ns)	UINT32	RO	0x000186A0 (100000 _{dec})
1C33:06	Calc and copy time	Time between reading of the inputs and availability of the inputs for the master (in ns, only DC mode)	UINT32	RO	0x00002710 (10000dez)
1C33:08	Command	With this entry the real required process data provision time can be measured. <ul style="list-style-type: none"> • 0: Measurement of the local cycle time is stopped • 1: Measurement of the local cycle time is started <p>The entries 1C33:03 [▶ 323], 1C33:06 [▶ 323], and 1C33:09 [▶ 323] are updated with the maximum measured values. For a subsequent measurement the measured values are reset</p>	UINT16	RW	0x0000 (0 _{dec})
1C33:09	Maximum Delay time	Time between SYNC1 event and reading of the inputs (in ns, only DC mode)	UINT32	RO	0x000186A0 (100000dez)
1C33:0B	SM event missed counter	Number of missed SM events in OPERATIONAL (DC mode only)	UINT16	RO	0x0000 (0 _{dec})
1C33:0C	Cycle exceeded counter	Number of occasions the cycle time was exceeded in OPERATIONAL (cycle was not completed in time or the next cycle began too early)	UINT16	RO	0x0000 (0 _{dec})
1C33:0D	Shift too short counter	Number of occasions that the interval between SYNC0 and SYNC1 event was too short (DC mode only)	UINT16	RO	0x0000 (0 _{dec})
1C33:20	Sync error	The synchronization was not correct in the last cycle (outputs were output too late; DC mode only)	BOOLEAN	RO	0x00 (0 _{dec})

***) since revision no. EL31xx-00xx-0016

Index F009* Password protection**

Index (hex)	Name	Meaning	Data type	Flags	Default
F009:0	Password protection	Password protection user calibration [▶ 259]	UINT32	RW	0x00000000 (0 _{dec})

***) for EL31xx, see [note \[▶ 259\]](#)

5.6.2.3 EL3114

5.6.2.3.1 Restore object

Index 1011 Restore default parameters

Index (hex)	Name	Meaning	Data type	Flags	Default
1011:0	Restore default parameters [▶ 503]	Restore default parameters	UINT8	RO	0x01 (1 _{dec})
1011:01	SubIndex 001	If this object is set to “0x64616F6C” in the set value dialog, all backup objects are reset to their delivery state.	UINT32	RW	0x00000000 (0 _{dec})

5.6.2.3.2 Configuration data

Index 80n0*** AI settings (for 0 ≤ n ≤ 3)

Index (hex)	Name	Meaning	Data type	Flags	Default
80n0:0	AI Settings	Maximum subindex	UINT8	RO	0x18 (24 _{dec})
80n0:01	Enable user scale [▶ 269]	User scale is active.	BOOLEAN	RW	0x00 (0 _{dec})
80n0:02	Presentation [▶ 244]	0: Signed presentation 1: Unsigned presentation 2: Absolute value with MSB as sign Signed amount representation	BIT3	RW	0x00 (0 _{dec})
80n0:05	Siemens bits [▶ 246]	The S5 bits are displayed in the three low-order bits	BOOLEAN	RW	0x00 (0 _{dec})
80n0:06	Enable filter	Enable filter, which makes PLC-cycle-synchronous data exchange unnecessary	BOOLEAN	RW	0x00 (0 _{dec})
80n0:07	Enable limit 1 [▶ 246]	Limit 1 enabled	BOOLEAN	RW	0x00 (0 _{dec})
80n0:08	Enable limit 2 [▶ 246]	Limit 2 enabled	BOOLEAN	RW	0x00 (0 _{dec})
80n0:0A	Enable user calibration [▶ 269]	Enabling of the user calibration	BOOLEAN	RW	0x00 (0 _{dec})
80n0:0B	Enable vendor calibration [▶ 269]	Enabling of the vendor calibration	BOOLEAN	RW	0x01 (1 _{dec})
80n0:0E	Swap limit bits [▶ 247]	Changing of the Limit Bits	BOOLEAN	RW	0x00 (0 _{dec})
80n0:11	User scale offset [▶ 269]	User scaling offset	INT16	RW	0x0000 (0 _{dec})
80n0:12	User scale gain [▶ 269]	User scaling gain. The gain is represented in fixed-point format, with the factor 2 ⁻¹⁶ . The value 1 corresponds to 65536 _{dec} (0x00010000) and is limited to ±0x7FFFF	INT32	RW	0x00010000 (65536 _{dec})
80n0:13	Limit 1 [▶ 246]	First limit value for setting the status bits	INT16	RW	0x0000 (0 _{dec})
80n0:14	Limit 2 [▶ 246]	Second limit value for setting the status bits	INT16	RW	0x0000 (0 _{dec})
80n0:15	Filter settings	This object determines the digital filter settings, if it is active via Enable filter (index 0x80n0:06 [▶ 325]). The possible settings are sequentially numbered. 0: 50 Hz FIR 1: 60 Hz FIR 2: IIR 1 3: IIR 2 4: IIR 3 5: IIR 4 6: IIR 5 7: IIR 6 8: IIR 7 9: IIR 8	UINT16	RW	0x0000 (0 _{dec})
80n0:17	User calibration offset [▶ 269]	User offset compensation	INT16	RW	0x0000 (0 _{dec})
80n0:18	User calibration gain [▶ 269]	User calibration gain	INT16	RW	0x4000 (16384 _{dec})

***) since revision no. EL31xx-00xx-0016

Filter

The filters of the EL30xx/EL31xx are activated or deactivated via the CoE index 0x8000:15.

i The filter characteristics are set via index 0x8000:15

The filter frequencies are set for all channels of the EL30xx/EL31xx terminals centrally via index 0x8000:15 (channel 1). All other corresponding indices 0x80n0:15 have no parameterization function! The latest firmware version (see [status table](#) [▶ 484]) returns an EtherCAT-compliant error message, if the filter characteristics of other channels (index 0x80n0:06, 0x80n0:15) are set.

5.6.2.3.3 Profile-specific objects (0x6000-0xFFFF)

The profile-specific objects have the same meaning for all EtherCAT slaves that support the profile 5001.

5.6.2.3.3.1 Input data

Index 60n0*** AI inputs (for $0 \leq n \leq 3$)

Index (hex)	Name	Meaning	Data type	Flags	Default
60n0:0	AI inputs	Maximum subindex	INT16	RO	0x11 (17 _{dec})
60n0:01	Underrange	Value below measuring range.	BOOLEAN	RO	0x00 (0 _{dec})
60n0:02	Overrange	Measuring range exceeded.	BOOLEAN	RO	0x00 (0 _{dec})
60n0:03	Limit 1	Limit value monitoring Limit 1 0: not active 1: value is smaller than limit value 1 2: value is larger than limit value 1 3: Value is equal to limit value 1	BIT2	RO	0x00 (0 _{dec})
60n0:05	Limit 2	Limit value monitoring limit 2 0: not active 1: value is smaller than limit value 2 2: value is larger than limit value 2 3: Value is equal to limit value 2	BIT2	RO	0x00 (0 _{dec})
60n0:07	Error	The error bit is set if the data is invalid (over-range, under-range)	BOOLEAN	RO	0x00 (0 _{dec})
60n0:0E	Sync error	The Sync error bit is only required for DC mode. It indicates whether a synchronization error has occurred during the previous cycle. This means a SYNC signal was triggered in the EL31xx, although no new process data were available (0=OK, 1=NOK).	BOOLEAN	RO	0x00 (0 _{dec})
60n0:0F	TxPDO State	Validity of the data of the associated TxPDO (0 = valid, 1 = invalid).	BOOLEAN	RO	0x00 (0 _{dec})
60n0:10	TxPDO Toggle	The TxPDO toggle is toggled by the slave when the data of the associated TxPDO is updated.	BOOLEAN	RO	0x00 (0 _{dec})
60n0:11	Value	Analog input date	INT16	RO	0x0000 (0 _{dec})

***) since revision no. EL31xx-00xx-0016

5.6.2.3.3.2 Configuration data (vendor-specific)

Index 80nF*** AI vendor data (for $0 \leq n \leq 3$)

Index (hex)	Name	Meaning	Data type	Flags	Default
80nF:0	AI vendor data	Maximum subindex	UINT8	RO	0x02 (2 _{dec})
80nF:01	Calibration offset	Offset (vendor calibration)	INT16	RW	0x0000 (0 _{dec})
80nF:02	Calibration gain	Gain (vendor calibration)	INT16	RW	0x4000 (16384 _{dec})

***) since revision no. EL31xx-00xx-0016

5.6.2.3.3 Information and diagnostic data

Index 80nE*** AI internal data (for $0 \leq n \leq 3$)

Index (hex)	Name	Meaning	Data type	Flags	Default
80nE:0	AI internal data	Maximum subindex	UINT8	RO	0x01 (1 _{dec})
80nE:01	ADC raw value	ADC raw value	UINT16	RO	-

***) since revision no. EL31xx-00xx-0016

Index F000*** Modular device profile

Index (hex)	Name	Meaning	Data type	Flags	Default
F000:0	Modular device profile	General information for the modular device profile	UINT8	RO	0x02 (2 _{dec})
F000:01	Module index distance	Index spacing of the objects of the individual channels	UINT16	RO	0x0010 (16 _{dec})
F000:02	Maximum number of modules	Number of channels	UINT16	RO	<i>Max. Channels number of the terminal</i>

***) since revision no. EL31xx-00xx-0016

Index F008*** Code word

Index	Name	Meaning	Data type	Flags	Default
F008:0	Code word	reserved	UINT32	RW	0x00000000 (0 _{dec})

***) since revision no. EL31xx-00xx-0016

Index F010*** module list (for $1 \leq n \leq 4$, depends on number of channels)

Index (hex)	Name	Meaning	Data type	Flags	Default
F010:0	Module list	Maximum subindex	UINT8	RW	0x0n
F010:0n	SubIndex 00n	Analog input profile (300)	UINT32	RW	0x0000012C (300 _{dec})

***) since revision no. EL31xx-00xx-0016

5.6.2.3.4 Standard objects

Standard objects (0x1000-0x1FFF)

The standard objects have the same meaning for all EtherCAT slaves.

Index 1000 Device type

Index (hex)	Name	Meaning	Data type	Flags	Default
1000:0	Device type	Device type of the EtherCAT slave: the Lo-Word contains the CoE profile used (5001). The Hi-Word contains the module profile according to the modular device profile.	UINT32	RO	0x012C1389 (19665801 _{dec})

Index 1008 Device name

Index (hex)	Name	Meaning	Data type	Flags	Default
1008:0	Device name	Device name of the EtherCAT slave	STRING	RO	EL31xx

Index 1009 Hardware version

Index (hex)	Name	Meaning	Data type	Flags	Default
1009:0	Hardware version	Hardware version of the EtherCAT slave	STRING	RO	00

Index 100A Software version

Index (hex)	Name	Meaning	Data type	Flags	Default
100A:0	Software version	Firmware version of the EtherCAT slave	STRING	RO	-

Index 1018 Identity

Index (hex)	Name	Meaning	Data type	Flags	Default
1018:0	Identity	Information for identifying the slave	UINT8	RO	0x04 (4 _{dec})
1018:01	Vendor ID	Vendor ID of the EtherCAT slave	UINT32	RO	0x00000002 (2 _{dec})
1018:02	Product code	Product code of the EtherCAT slave	UINT32	RO	0xFFFF3052
1018:03	Revision	Revision number of the EtherCAT slave; the low word (bit 0-15) indicates the special terminal number, the high word (bit 16-31) refers to the device description	UINT32	RO	-
1018:04	Serial number	Serial number of the EtherCAT slave; the low byte (bit 0-7) of the low word contains the year of production, the high byte (bit 8-15) of the low word contains the week of production, the high word (bit 16-31) is 0	UINT32	RO	-

Index 10F0* Backup parameter handling**

Index (hex)	Name	Meaning	Data type	Flags	Default
10F0:0	Backup parameter handling	Information for standardized loading and saving of backup entries	UINT8	RO	0x01 (1 _{dec})
10F0:01	Checksum	Checksum across all backup entries of the EtherCAT slave	UINT32	RO	-

***) since revision no. EL31xx-00xx-0016

Index 1800 AI TxPDO-Par Standard Ch.1

Index (hex)	Name	Meaning	Data type	Flags	Default
1800:0	AI TxPDO-Par Standard Ch.1	PDO parameter TxPDO 1	UINT8	RO	0x06 (6 _{dec})
1800:06	Exclude TxPDOs	Specifies the TxPDOs (index of TxPDO mapping objects) that must not be transferred together with TxPDO 1	OCTET-STRING[2]	RO	01 1A

Index 1801 AI TxPDO-Par Compact Ch.1

Index (hex)	Name	Meaning	Data type	Flags	Default
1801:0	AI TxPDO-Par Compact Ch.1	PDO parameter TxPDO 2	UINT8	RO	0x06 (6 _{dec})
1801:06	Exclude TxPDOs	Specifies the TxPDOs (index of TxPDO mapping objects) that must not be transferred together with TxPDO 2	OCTET-STRING[2]	RO	00 1A

Index 1802 AI TxPDO-Par Standard Ch.2

Index (hex)	Name	Meaning	Data type	Flags	Default
1802:0	AI TxPDO-Par Standard Ch.2	PDO parameter TxPDO 3	UINT8	RO	0x06 (6 _{dec})
1802:06	Exclude TxPDOs	Specifies the TxPDOs (index of TxPDO mapping objects) that must not be transferred together with TxPDO 3	OCTET-STRING[2]	RO	03 1A

Index 1803 AI TxPDO-Par Compact Ch. 2

Index (hex)	Name	Meaning	Data type	Flags	Default
1803:0	AI TxPDO-Par Compact Ch.2	PDO parameter TxPDO 4	UINT8	RO	0x06 (6 _{dec})
1803:06	Exclude TxPDOs	Specifies the TxPDOs (index of TxPDO mapping objects) that must not be transferred together with TxPDO 4	OCTET-STRING[2]	RO	02 1A

Index 1804 AI TxPDO-Par Standard Ch.3

Index (hex)	Name	Meaning	Data type	Flags	Default
1804:0	AI TxPDO-Par Standard Ch.3	PDO parameter TxPDO 5	UINT8	RO	0x06 (6 _{dec})
1804:06	Exclude TxPDOs	Specifies the TxPDOs (index of TxPDO mapping objects) that must not be transferred together with TxPDO 5	OCTET-STRING[2]	RO	05 1A

Index 1805 AI TxPDO-Par Compact Ch. 3

Index (hex)	Name	Meaning	Data type	Flags	Default
1805:0	AI TxPDO-Par Compact Ch.3	PDO parameter TxPDO 6	UINT8	RO	0x06 (6 _{dec})
1805:06	Exclude TxPDOs	Specifies the TxPDOs (index of TxPDO mapping objects) that must not be transferred together with TxPDO 6	OCTET-STRING[2]	RO	04 1A

Index 1806 AI TxPDO-Par Standard Ch.4

Index (hex)	Name	Meaning	Data type	Flags	Default
1806:0	AI TxPDO-Par Standard Ch.4	PDO parameter TxPDO 7	UINT8	RO	0x06 (6 _{dec})
1806:06	Exclude TxPDOs	Specifies the TxPDOs (index of TxPDO mapping objects) that must not be transferred together with TxPDO 7	OCTET-STRING[2]	RO	07 1A

Index 1807 AI TxPDO-Par Compact Ch. 4

Index (hex)	Name	Meaning	Data type	Flags	Default
1807:0	AI TxPDO-Par Compact Ch.4	PDO parameter TxPDO 8	UINT8	RO	0x06 (6 _{dec})
1807:06	Exclude TxPDOs	Specifies the TxPDOs (index of TxPDO mapping objects) that must not be transferred together with TxPDO 8	OCTET-STRING[2]	RO	06 1A

Index 1A00 AI TxPDO-Map Standard Ch.1

Index (hex)	Name	Meaning	Data type	Flags	Default
1A00:0	AI TxPDO-Map Standard Ch.1	PDO Mapping TxPDO	UINT8	RO	0x0B (11 _{dec})
1A00:01	SubIndex 001	1. PDO Mapping entry (object 0x6000 (AI Inputs), entry 0x01 (Underrange))	UINT32	RO	0x6000:01, 1
1A00:02	SubIndex 002	2. PDO Mapping entry (object 0x6000 (AI Inputs), entry 0x02 (Ovrrange))	UINT32	RO	0x6000:02, 1
1A00:03	SubIndex 003	3. PDO Mapping entry (object 0x6000 (AI Inputs), entry 0x03 (Limit 1))	UINT32	RO	0x6000:03, 2
1A00:04	SubIndex 004	4. PDO Mapping entry (object 0x6000 (AI Inputs), entry 0x05 (Limit 2))	UINT32	RO	0x6000:05, 2
1A00:05	SubIndex 005	5. PDO Mapping entry (object 0x6000 (AI Inputs), entry 0x07 (Error))	UINT32	RO	0x6000:07, 1
1A00:06	SubIndex 006	6. PDO Mapping entry (1 bit align)	UINT32	RO	0x0000:00, 1
1A00:07	SubIndex 007	7. PDO Mapping entry (5 bits align)	UINT32	RO	0x0000:00, 5
1A00:08	SubIndex 008	8. PDO Mapping entry (object 0x6000 (AI Inputs), entry 0x0E (Sync Error))	UINT32	RO	0x6000:0E, 1
1A00:09	SubIndex 009	9. PDO Mapping entry (object 0x6000 (AI Inputs), entry 0x0F (TxPDO State))	UINT32	RO	0x6000:0F, 1
1A00:0A	SubIndex 010	10. PDO Mapping entry (object 0x6000 (AI Inputs), entry 0x10 (TxPDO Toggle))	UINT32	RO	0x6000:10, 1
1A00:0B	SubIndex 011	11. PDO Mapping entry (object 0x6000 (AI Inputs), entry 0x11 (Value))	UINT32	RO	0x6000:11, 16

Index 1A01 AI TxPDO-Map Compact Ch.1

Index (hex)	Name	Meaning	Data type	Flags	Default
1A01:0	AI TxPDO-Map Compact Ch.1	PDO Mapping TxPDO 2	UINT8	RO	0x01 (1 _{dec})
1A01:01	SubIndex 001	1. PDO Mapping entry (object 0x6000 (AI Inputs), entry 0x11 (Value))	UINT32	RO	0x6000:11, 16

Index 1A02 AI TxPDO-Map Standard Ch.

Index (hex)	Name	Meaning	Data type	Flags	Default
1A02:0	AI TxPDO-Map Standard Ch.2	PDO Mapping TxPDO	UINT8	RO	0x0B (11 _{dec})
1A02:01	SubIndex 001	1. PDO Mapping entry (object 0x6010 (AI Inputs), entry 0x01 (Underrange))	UINT32	RO	0x6010:01, 1
1A02:02	SubIndex 002	2. PDO Mapping entry (object 0x6010 (AI Inputs), entry 0x02 (Overrange))	UINT32	RO	0x6010:02, 1
1A02:03	SubIndex 003	3. PDO Mapping entry (object 0x6010 (AI Inputs), entry 0x03 (Limit 1))	UINT32	RO	0x6010:03, 2
1A02:04	SubIndex 004	4. PDO Mapping entry (object 0x6010 (AI Inputs), entry 0x05 (Limit 2))	UINT32	RO	0x6010:05, 2
1A02:05	SubIndex 005	5. PDO Mapping entry (object 0x6010 (AI Inputs), entry 0x07 (Error))	UINT32	RO	0x6010:07, 1
1A02:06	SubIndex 006	6. PDO Mapping entry (1 bit align)	UINT32	RO	0x0000:00, 1
1A02:07	SubIndex 007	7. PDO Mapping entry (5 bits align)	UINT32	RO	0x0000:00, 5
1A02:08	SubIndex 008	8. PDO Mapping entry (object 0x6010 (AI Inputs), entry 0x0E (Sync Error))	UINT32	RO	0x6010:0E, 1
1A02:09	SubIndex 009	9. PDO Mapping entry (object 0x6010 (AI Inputs), entry 0x0F (TxPDO State))	UINT32	RO	0x6010:0F, 1
1A02:0A	SubIndex 010	10. PDO Mapping entry (object 0x6010 (AI Inputs), entry 0x10 (TxPDO Toggle))	UINT32	RO	0x6010:10, 1
1A02:0B	SubIndex 011	11. PDO Mapping entry (object 0x6010 (AI Inputs), entry 0x11 (Value))	UINT32	RO	0x6010:11, 16

Index 1A03 AI TxPDO-Map Compact Ch.2

Index (hex)	Name	Meaning	Data type	Flags	Default
1A03:0	AI TxPDO-Map Compact Ch.2	PDO Mapping TxPDO 4	UINT8	RO	0x01 (1 _{dec})
1A03:01	SubIndex 001	1. PDO Mapping entry (object 0x6010 (AI Inputs), entry 0x11 (Value))	UINT32	RO	0x6010:11, 16

Index 1A04 AI TxPDO-Map Standard Ch.3

Index (hex)	Name	Meaning	Data type	Flags	Default
1A04:0	AI TxPDO-Map Standard Ch.3	PDO Mapping TxPDO	UINT8	RO	0x0B (11 _{dec})
1A04:01	SubIndex 001	1. PDO Mapping entry (object 0x6020 (AI Inputs), entry 0x01 (Underrange))	UINT32	RO	0x6020:01, 1
1A04:02	SubIndex 002	2. PDO Mapping entry (object 0x6020 (AI Inputs), entry 0x02 (Overrange))	UINT32	RO	0x6020:02, 1
1A04:03	SubIndex 003	3. PDO Mapping entry (object 0x6020 (AI Inputs), entry 0x03 (Limit 1))	UINT32	RO	0x6020:03, 2
1A04:04	SubIndex 004	4. PDO Mapping entry (object 0x6020 (AI Inputs), entry 0x05 (Limit 2))	UINT32	RO	0x6020:05, 2
1A04:05	SubIndex 005	5. PDO Mapping entry (object 0x6020 (AI Inputs), entry 0x07 (Error))	UINT32	RO	0x6020:07, 1
1A04:06	SubIndex 006	6. PDO Mapping entry (1 bit align)	UINT32	RO	0x0000:00, 1
1A04:07	SubIndex 007	7. PDO Mapping entry (5 bits align)	UINT32	RO	0x0000:00, 5
1A04:08	SubIndex 008	8. PDO Mapping entry (object 0x6020 (AI Inputs), entry 0x0E (Sync Error))	UINT32	RO	0x6020:0E, 1
1A04:09	SubIndex 009	9. PDO Mapping entry (object 0x6020 (AI Inputs), entry 0x0F (TxPDO State))	UINT32	RO	0x6020:0F, 1
1A04:0A	SubIndex 010	10. PDO Mapping entry (object 0x6020 (AI Inputs), entry 0x10 (TxPDO Toggle))	UINT32	RO	0x6020:10, 1
1A04:0B	SubIndex 011	11. PDO Mapping entry (object 0x6020 (AI Inputs), entry 0x11 (Value))	UINT32	RO	0x6020:11, 16

Index 1A05 AI TxPDO-Map Compact Ch.3

Index (hex)	Name	Meaning	Data type	Flags	Default
1A05:0	AI TxPDO-Map Compact Ch.3	PDO Mapping TxPDO 6	UINT8	RO	0x01 (1 _{dec})
1A05:01	SubIndex 001	1. PDO Mapping entry (object 0x6020 (AI Inputs), entry 0x11 (Value))	UINT32	RO	0x6020:11, 16

Index 1A06 AI TxPDO-Map Standard Ch.4

Index (hex)	Name	Meaning	Data type	Flags	Default
1A06:0	AI TxPDO-Map Standard Ch.4	PDO Mapping TxPDO	UINT8	RO	0x0B (11 _{dec})
1A06:01	SubIndex 001	1. PDO Mapping entry (object 0x6030 (AI Inputs), entry 0x01 (Underrange))	UINT32	RO	0x6030:01, 1
1A06:02	SubIndex 002	2. PDO Mapping entry (object 0x6030 (AI Inputs), entry 0x02 (Overrange))	UINT32	RO	0x6030:02, 1
1A06:03	SubIndex 003	3. PDO Mapping entry (object 0x6030 (AI Inputs), entry 0x03 (Limit 1))	UINT32	RO	0x6030:03, 2
1A06:04	SubIndex 004	4. PDO Mapping entry (object 0x6030 (AI Inputs), entry 0x05 (Limit 2))	UINT32	RO	0x6030:05, 2
1A06:05	SubIndex 005	5. PDO Mapping entry (object 0x6030 (AI Inputs), entry 0x07 (Error))	UINT32	RO	0x6030:07, 1
1A06:06	SubIndex 006	6. PDO Mapping entry (1 bit align)	UINT32	RO	0x0000:00, 1
1A06:07	SubIndex 007	7. PDO Mapping entry (5 bits align)	UINT32	RO	0x0000:00, 5
1A06:08	SubIndex 008	8. PDO Mapping entry (object 0x6030 (AI Inputs), entry 0x0E (Sync Error))	UINT32	RO	0x6030:0E, 1
1A06:09	SubIndex 009	9. PDO Mapping entry (object 0x6030 (AI Inputs), entry 0x0F (TxPDO State))	UINT32	RO	0x6030:0F, 1
1A06:0A	SubIndex 010	10. PDO Mapping entry (object 0x6030 (AI Inputs), entry 0x10 (TxPDO Toggle))	UINT32	RO	0x6030:10, 1
1A06:0B	SubIndex 011	11. PDO Mapping entry (object 0x6030 (AI Inputs), entry 0x11 (Value))	UINT32	RO	0x6030:11, 16

Index 1A07 AI TxPDO-Map Compact Ch.4

Index (hex)	Name	Meaning	Data type	Flags	Default
1A07:0	AI TxPDO-Map Compact Ch.4	PDO Mapping TxPDO 8	UINT8	RO	0x01 (1 _{dec})
1A07:01	SubIndex 001	1. PDO Mapping entry (object 0x6030 (AI Inputs), entry 0x11 (Value))	UINT32	RO	0x6030:11, 16

Index 1C00 Sync manager type

Index (hex)	Name	Meaning	Data type	Flags	Default
1C00:0	Sync manager type	Using the sync managers	UINT8	RO	0x04 (4 _{dec})
1C00:01	SubIndex 001	Sync-Manager Type Channel 1: Mailbox Write	UINT8	RO	0x01 (1 _{dec})
1C00:02	SubIndex 002	Sync-Manager Type Channel 2: Mailbox Read	UINT8	RO	0x02 (2 _{dec})
1C00:03	SubIndex 003	Sync-Manager Type Channel 3: Process Data Write (Outputs)	UINT8	RO	0x03 (3 _{dec})
1C00:04	SubIndex 004	Sync-Manager Type Channel 4: Process Data Read (Inputs)	UINT8	RO	0x04 (4 _{dec})

Index 1C12 RxPDO assign

Index (hex)	Name	Meaning	Data type	Flags	Default
1C12:0	RxPDO assign	PDO Assign Outputs	UINT8	RW	0x00 (0 _{dec})

Index 1C13 TxPDO assign

For operation on masters other than TwinCAT it must be ensured that the channels are entered in the PDO assignment ("TxPDO assign", object 0x1C13) successively.

Index (hex)	Name	Meaning	Data type	Flags	Default
1C13:0	TxPDO assign	PDO Assign Inputs	UINT8	RW	0x04 (4 _{dec})
1C13:01	SubIndex 001	1. zugeordnete TxPDO (enthält den Index des zugehörigen TxPDO Mapping Objekts)	UINT16	RW	0x1A00 (6656 _{dec})
1C13:02	SubIndex 002	2. zugeordnete TxPDO (enthält den Index des zugehörigen TxPDO Mapping Objekts)	UINT16	RW	0x1A02 (6658 _{dec})
1C13:03	SubIndex 003	3. zugeordnete TxPDO (enthält den Index des zugehörigen TxPDO Mapping Objekts)	UINT16	RW	0x1A04 (6660 _{dec})
1C13:04	SubIndex 004	4. zugeordnete TxPDO (enthält den Index des zugehörigen TxPDO Mapping Objekts)	UINT16	RW	0x1A06 (6662 _{dec})

Index 1C33 SM input parameter

Index (hex)	Name	Meaning	Data type	Flags	Default
1C33:0	SM input parameter	Synchronization parameters for the inputs	UINT8	RO	0x20 (32 _{dec})
1C33:01	Sync mode	Current synchronization mode: <ul style="list-style-type: none"> • Bit 0 = 0: Free Run • Bit 0 = 1: Synchron with SM 2 Event • Bit 15 = 0: Standard • Bit 15 = 1: FastOp mode (CoE deactivated) 	UINT16	RW	0x0000 (0 _{dec})
1C33:02	Cycle time	Cycle time (in ns): <ul style="list-style-type: none"> • Free Run: Cycle time of the local timer • Synchronous with SM 2 event: Master cycle time • DC-Mode: SYNC0/SYNC1 Cycle Time 	UINT32	RW	0x000F4240 (1000000 _{dec})
1C33:03	Shift time	Time between SYNC0 event and reading of the inputs (in ns, only DC mode)	UINT32	RO	0x00000000 (0 _{dec})
1C33:04	Sync modes supported	Supported synchronization modes: <ul style="list-style-type: none"> • Bit 0: free run is supported • Bit 1: synchronous with SM 2 event is supported (outputs available) • Bit 1: synchronous with SM 3 event is supported (no outputs available) • Bit 2-3 = 01: DC mode is supported • Bit 4-5 = 01: input shift through local event (outputs available) • Bit 4-5 = 10: input shift with SYNC1 event (no outputs available) • Bit 14 = 1: dynamic times (measurement through writing of 0x1C33:08) 	UINT16	RO	0xC003 (49155 _{dec})
1C33:05	Minimum cycle time	Minimum cycle time (in ns)	UINT32	RO	0x0000FDE8 (65000 _{dec})
1C33:06	Calc and copy time	Time between reading of the inputs and availability of the inputs for the master (in ns, only DC mode)	UINT32	RO	0x00000000 (0 _{dec})
1C33:07	Minimum delay time		UINT32	RO	0x00000000 (0 _{dec})
1C33:08	Get cycle time	With this entry the real required process data provision time can be measured. <ul style="list-style-type: none"> • 0: Measurement of the local cycle time is stopped • 1: Measurement of the local cycle time is started The entries 0x1C33:03, 0x1C33:06, 1C33:09 are updated with the maximum measured values. For a subsequent measurement the measured values are reset.	UINT16	RW	0x0000 (0 _{dec})
1C33:09	Maximum delay time	Time between SYNC1 event and reading of the inputs (in ns, only DC mode)	UINT32	RO	0x00000000 (0 _{dec})
1C33:0B	SM event missed counter	Number of missed SM events in OPERATIONAL (DC mode only)	UINT16	RO	0x0000 (0 _{dec})
1C33:0C	Cycle exceeded counter	Number of occasions the cycle time was exceeded in OPERATIONAL (cycle was not completed in time or the next cycle began too early)	UINT16	RO	0x0000 (0 _{dec})
1C33:0D	Shift too short counter	Number of occasions that the interval between SYNC0 and SYNC1 event was too short (DC mode only)	UINT16	RO	0x0000 (0 _{dec})
1C33:20	Sync error	The synchronization was not correct in the last cycle (outputs were output too late; DC mode only)	BOOLEAN	RO	0x00 (0 _{dec})

Index F009* Password protection**

Index (hex)	Name	Meaning	Data type	Flags	Default
F009:0	Password protection	Password protection user calibration [► 259]	UINT32	RW	0x00000000 (0 _{dec})

***) for EL31xx, see [note](#) [► 259]

5.6.3 EL312x

5.6.3.1 EL3121

5.6.3.1.1 Restore object

Index 1011 Restore default parameters

Index (hex)	Name	Meaning	Data type	Flags	Default
1011:0	Restore default parameters [►_503]	Restore default parameters	UINT8	RO	0x01 (1 _{dec})
1011:01	SubIndex 001	If this object is set to "0x64616F6C" in the set value dialog, all backup objects are reset to their delivery state.	UINT32	RW	0x00000000 (0 _{dec})

5.6.3.1.2 Configuration data

Index 8000 AI settings

Index (hex)	Name	Meaning	Data type	Flags	Default
8000:0	AI Settings	Maximum subindex	UINT8	RO	0x18 (24 _{dec})
8000:01	Enable user scale [▶ 269]	User scale is active.	BOOLEAN	RW	0x00 (0 _{dec})
8000:02	Presentation [▶ 244]	0: Signed presentation 1: Unsigned presentation 2: Absolute value with MSB as sign Signed amount representation	BIT3	RW	0x00 (0 _{dec})
8000:05	Siemens bits [▶ 246]	The S5 bits are displayed in the three low-order bits	BOOLEAN	RW	0x00 (0 _{dec})
8000:06	Enable filter	Enable filter, which makes PLC-cycle-synchronous data exchange unnecessary	BOOLEAN	RW	0x00 (0 _{dec})
8000:07	Enable limit 1 [▶ 246]	Limit 1 enabled	BOOLEAN	RW	0x00 (0 _{dec})
8000:08	Enable limit 2 [▶ 246]	Limit 2 enabled	BOOLEAN	RW	0x00 (0 _{dec})
8000:0A	Enable user calibration [▶ 269]	Enabling of the user calibration	BOOLEAN	RW	0x00 (0 _{dec})
8000:0B	Enable vendor calibration [▶ 269]	Enabling of the vendor calibration	BOOLEAN	RW	0x01 (1 _{dec})
8000:0E	Swap limit bits [▶ 247]	Changing of the Limit Bits	BOOLEAN	RW	0x00 (0 _{dec})
80n0:11	User scale offset [▶ 269]	User scaling offset	INT16	RW	0x0000 (0 _{dec})
80n0:12	User scale gain [▶ 269]	User scaling gain. The gain is represented in fixed-point format, with the factor 2 ⁻¹⁶ . The value 1 corresponds to 65536 _{dec} (0x00010000) and is limited to ±0x7FFFF	INT32	RW	0x00010000 (65536 _{dec})
80n0:13	Limit 1 [▶ 246]	First limit value for setting the status bits	INT16	RW	0x0000 (0 _{dec})
80n0:14	Limit 2 [▶ 246]	Second limit value for setting the status bits	INT16	RW	0x0000 (0 _{dec})
80n0:15	Filter settings	This object determines the digital filter settings, if it is active via Enable filter (index 0x8000:06 [▶ 335]). The possible settings are sequentially numbered. 0: 50 Hz FIR 1: 60 Hz FIR 2: IIR 1 3: IIR 2 4: IIR 3 5: IIR 4 6: IIR 5 7: IIR 6 8: IIR 7 9: IIR 8	UINT16	RW	0x0000 (0 _{dec})
80n0:17	User calibration offset [▶ 269]	User offset compensation	INT16	RW	0x0000 (0 _{dec})
80n0:18	User calibration gain [▶ 269]	User calibration gain	INT16	RW	0x4000 (16384 _{dec})

***) since revision no. EL31xx-00xx-0016



The filter characteristics are set via index [0x8000:15](#) [\[▶ 335\]](#)

The filter frequencies are set for all channels of the EL31xx terminals centrally via index [0x8000:15](#) [\[▶ 335\]](#) (channel 1). All other corresponding indices 0x80n0:15 have no parameterization function!

5.6.3.1.3 Profile-specific objects (0x6000-0xFFFF)

The profile-specific objects have the same meaning for all EtherCAT slaves that support the profile 5001.

5.6.3.1.3.1 Input data

Index 6000 AI inputs

Index (hex)	Name	Meaning	Data type	Flags	Default
6000:0	AI inputs	Maximum subindex	INT16	RO	0x11 (17 _{dec})
6000:01	Underrange	Value below measuring range.	BOOLEAN	RO	0x00 (0 _{dec})
6000:02	Overrange	Measuring range exceeded.	BOOLEAN	RO	0x00 (0 _{dec})
6000:03	Limit 1	Limit value monitoring Limit 1 0: not active 1: value is smaller than limit value 1 2: value is larger than limit value 1 3: Value is equal to limit value 1	BIT2	RO	0x00 (0 _{dec})
6000:05	Limit 2	Limit value monitoring limit 2 0: not active 1: value is smaller than limit value 2 2: value is larger than limit value 2 3: Value is equal to limit value 2	BIT2	RO	0x00 (0 _{dec})
6000:07	Error	The error bit is set if the data is invalid (over-range, under-range)	BOOLEAN	RO	0x00 (0 _{dec})
6000:0E	Sync error	The Sync error bit is only required for DC mode. It indicates whether a synchronization error has occurred during the previous cycle. This means a SYNC signal was triggered in the EL31xx, although no new process data were available (0=OK, 1=NOK).	BOOLEAN	RO	0x00 (0 _{dec})
6000:0F	TxPDO State	Validity of the data of the associated TxPDO (0 = valid, 1 = invalid).	BOOLEAN	RO	0x00 (0 _{dec})
60n0:10	TxPDO Toggle	The TxPDO toggle is toggled by the slave when the data of the associated TxPDO is updated.	BOOLEAN	RO	0x00 (0 _{dec})
60n0:11	Value	Analog input date	INT16	RO	0x0000 (0 _{dec})

5.6.3.1.3.2 Configuration data (vendor-specific)

Index 800F AI vendor data

Index (hex)	Name	Meaning	Data type	Flags	Default
800F:0	AI vendor data	Maximum subindex	UINT8	RO	0x02 (2 _{dec})
800F:01	Calibration offset	Offset (vendor calibration)	INT16	RW	0x0000 (0 _{dec})
800F:02	Calibration gain	Gain (vendor calibration)	INT16	RW	0x4000 (16384 _{dec})

5.6.3.1.3.3 Information and diagnostic data

Index 800E AI internal data

Index (hex)	Name	Meaning	Data type	Flags	Default
800E:0	AI internal data	Maximum subindex	UINT8	RO	0x01 (1 _{dec})
800E:01	ADC raw value	ADC raw value	UINT16	RO	-

Index F000*** Modular device profile

Index (hex)	Name	Meaning	Data type	Flags	Default
F000:0	Modular device profile	General information for the modular device profile	UINT8	RO	0x02 (2 _{dec})
F000:01	Module index distance	Index spacing of the objects of the individual channels	UINT16	RO	0x0010 (16 _{dec})
F000:02	Maximum number of modules	Number of channels	UINT16	RO	<i>Max. Channels number of the terminal</i>

***) since revision no. EL31xx-00xx-0016

Index F008* Code word**

Index	Name	Meaning	Data type	Flags	Default
F008:0	Code word	reserved	UINT32	RW	0x00000000 (0 _{dec})

***) since revision no. EL31xx-00xx-0016

Index F009* Password protection**

Index (hex)	Name	Meaning	Data type	Flags	Default
F009:0	Password protection	Password protection user calibration [▶ 259]	UINT32	RW	0x00000000 (0 _{dec})

***) for EL31xx, see [note \[▶ 259\]](#)

Index F010* module list (for 1 ≤ n ≤ 4, depends on number of channels)**

Index (hex)	Name	Meaning	Data type	Flags	Default
F010:0	Module list	Maximum subindex	UINT8	RW	0x0n
F010:0n	SubIndex 00n	Analog input profile (300)	UINT32	RW	0x0000012C (300 _{dec})

***) since revision no. EL31xx-00xx-0016

5.6.3.1.4 Standard objects

Standard objects (0x1000-0x1FFF)

The standard objects have the same meaning for all EtherCAT slaves.

Index 1000 Device type

Index (hex)	Name	Meaning	Data type	Flags	Default
1000:0	Device type	Device type of the EtherCAT slave: the Lo-Word contains the CoE profile used (5001). The Hi-Word contains the module profile according to the modular device profile.	UINT32	RO	0x012C1389 (19665801 _{dec})

Index 1008 Device name

Index (hex)	Name	Meaning	Data type	Flags	Default
1008:0	Device name	Device name of the EtherCAT slave	STRING	RO	EL31xx

Index 1009 Hardware version

Index (hex)	Name	Meaning	Data type	Flags	Default
1009:0	Hardware version	Hardware version of the EtherCAT slave	STRING	RO	00

Index 100A Software version

Index (hex)	Name	Meaning	Data type	Flags	Default
100A:0	Software version	Firmware version of the EtherCAT slave	STRING	RO	-

Index 1018 Identity

Index (hex)	Name	Meaning	Data type	Flags	Default
1018:0	Identity	Information for identifying the slave	UINT8	RO	0x04 (4 _{dec})
1018:01	Vendor ID	Vendor ID of the EtherCAT slave	UINT32	RO	0x00000002 (2 _{dec})
1018:02	Product code	Product code of the EtherCAT slave	UINT32	RO	0xFFFF3052
1018:03	Revision	Revision number of the EtherCAT slave; the low word (bit 0-15) indicates the special terminal number, the high word (bit 16-31) refers to the device description	UINT32	RO	-
1018:04	Serial number	Serial number of the EtherCAT slave; the low byte (bit 0-7) of the low word contains the year of production, the high byte (bit 8-15) of the low word contains the week of production, the high word (bit 16-31) is 0	UINT32	RO	-

Index 10F0* Backup parameter handling**

Index (hex)	Name	Meaning	Data type	Flags	Default
10F0:0	Backup parameter handling	Information for standardized loading and saving of backup entries	UINT8	RO	0x01 (1 _{dec})
10F0:01	Checksum	Checksum across all backup entries of the EtherCAT slave	UINT32	RO	-

***) since revision no. EL31xx-00xx-0016

Index 1800 AI TxPDO-Par Standard Ch.1

Index (hex)	Name	Meaning	Data type	Flags	Default
1800:0	AI TxPDO-Par Standard Ch.1	PDO parameter TxPDO 1	UINT8	RO	0x06 (6 _{dec})
1800:06	Exclude TxPDOs	Specifies the TxPDOs (index of TxPDO mapping objects) that must not be transferred together with TxPDO 1	OCTET-STRING[2]	RO	01 1A

Index 1801 AI TxPDO-Par Compact Ch.1

Index (hex)	Name	Meaning	Data type	Flags	Default
1801:0	AI TxPDO-Par Compact Ch.1	PDO parameter TxPDO 2	UINT8	RO	0x06 (6 _{dec})
1801:06	Exclude TxPDOs	Specifies the TxPDOs (index of TxPDO mapping objects) that must not be transferred together with TxPDO 2	OCTET-STRING[2]	RO	00 1A

Index 1A0n AI TxPDO-Map Standard (for n = 0, 2, 4, 6; p = 0, 1, 2, 3; depending on the number of channels, not applicable for EL31x2)

Index (hex)	Name	Meaning	Data type	Flags	Default
1A0n:0	AI TxPDO-Map standard	PDO Mapping TxPDO	UINT8	RO	0x0B (11 _{dec})
1A0n:01	SubIndex 001	1. PDO Mapping entry (object 0x60p0 (AI Inputs), entry 0x01 (Underrange))	UINT32	RO	0x60p0:01, 1
1A0n:02	SubIndex 002	2. PDO Mapping entry (object 0x60p0 (AI Inputs), entry 0x02 (Overrange))	UINT32	RO	0x60p0:02, 1
1A0n:03	SubIndex 003	3. PDO Mapping entry (object 0x60p0 (AI Inputs), entry 0x03 (Limit 1))	UINT32	RO	0x60p0:03, 2
1A0n:04	SubIndex 004	4. PDO Mapping entry (object 0x60p0 (AI Inputs), entry 0x05 (Limit 2))	UINT32	RO	0x60p0:05, 2
1A0n:05	SubIndex 005	5. PDO Mapping entry (object 0x60p0 (AI Inputs), entry 0x07 (Error))	UINT32	RO	0x60p0:07, 2
1A0n:06	SubIndex 006	6. PDO Mapping entry (1 bit align)	UINT32	RO	0x0000:00, 1
1A0n:07	SubIndex 007	7. PDO Mapping entry (5 bits align)	UINT32	RO	0x0000:00, 5
1A0n:08	SubIndex 008	8. PDO Mapping entry (object 0x1C32 (SM input parameter), entry 0x20 (Sync error))	UINT32	RO	0x1C32:20, 1
1A0n:09	SubIndex 009	9. PDO Mapping entry (object 0x180n (AI TxPDO-Par standard), entry 0x07 (TxPDO State))	UINT32	RO	0x180n:07, 1
1A0n:0A	SubIndex 010	10. PDO Mapping entry (object 0x180n (AI TxPDO-Par standard), entry 0x09 (TxPDO Toggle))	UINT32	RO	0x180n:09, 1
1A0n:0B	SubIndex 011	11. PDO Mapping entry (object 0x60p0 (AI Inputs), entry 0x11 (Value))	UINT32	RO	0x60p0:11, 16

Index 1A01 AI TxPDO-Map Compact Ch.1

Index (hex)	Name	Meaning	Data type	Flags	Default
1A01:0	AI TxPDO-Map Compact Ch.1	PDO Mapping TxPDO 2	UINT8	RO	0x01 (1 _{dec})
1A01:01	SubIndex 001	1. PDO Mapping entry (object 0x6000 (AI Inputs), entry 0x11 (Value))	UINT32	RO	0x6000:11, 16

Index 1C00 Sync manager type

Index (hex)	Name	Meaning	Data type	Flags	Default
1C00:0	Sync manager type	Using the sync managers	UINT8	RO	0x04 (4 _{dec})
1C00:01	SubIndex 001	Sync-Manager Type Channel 1: Mailbox Write	UINT8	RO	0x01 (1 _{dec})
1C00:02	SubIndex 002	Sync-Manager Type Channel 2: Mailbox Read	UINT8	RO	0x02 (2 _{dec})
1C00:03	SubIndex 003	Sync-Manager Type Channel 3: Process Data Write (Outputs)	UINT8	RO	0x03 (3 _{dec})
1C00:04	SubIndex 004	Sync-Manager Type Channel 4: Process Data Read (Inputs)	UINT8	RO	0x04 (4 _{dec})

Index 1C12 RxPDO assign

Index (hex)	Name	Meaning	Data type	Flags	Default
1C12:0	RxPDO assign	PDO Assign Outputs	UINT8	RW	0x00 (0 _{dec})

Index 1C13 TxPDO assign (not applicable for EL31x2)

For operation on masters other than TwinCAT it must be ensured that the channels are entered in the PDO assignment ("TxPDO assign", object 0x1C13) successively.

Index (hex)	Name	Meaning	Data type	Flags	Default
1C13:0	TxPDO assign	PDO Assign Inputs	UINT8	RW	0x04 (4 _{dec})
1C13:01	SubIndex 001	1. allocated TxPDO (contains the index of the associated TxPDO mapping object)	UINT16	RW	0x1A00 (6656 _{dec})
1C13:02*	SubIndex 002	2. allocated TxPDO (contains the index of the associated TxPDO mapping object)	UINT16	RW	0x1A02 (6658 _{dec})
1C13:03*	SubIndex 003	3. allocated TxPDO (contains the index of the associated TxPDO mapping object)	UINT16	RW	0x1A04 (6660 _{dec})
1C13:04*	SubIndex 004	4. allocated TxPDO (contains the index of the associated TxPDO mapping object)	UINT16	RW	0x1A06 (6662 _{dec})

*) only for EL31x4

Index 1C33 SM input parameter

Index (hex)	Name	Meaning	Data type	Flags	Default
1C33:0	SM input parameter	Synchronization parameters for the inputs	UINT8	RO	0x20 (32 _{dec})
1C33:01	Sync mode	Current synchronization mode: <ul style="list-style-type: none"> • Bit 0 = 0: Free Run • Bit 0 = 1: Synchron with SM 2 Event • Bit 15 = 0: Standard • Bit 15 = 1: FastOp mode (CoE deactivated) 	UINT16	RW	0x0000 (0 _{dec})
1C33:02	Cycle time	Cycle time (in ns): <ul style="list-style-type: none"> • Free Run: Cycle time of the local timer • Synchronous with SM 2 event: Master cycle time • DC-Mode: SYNC0/SYNC1 Cycle Time 	UINT32	RW	0x000F4240 (1000000 _{dec})
1C33:03	Shift time	Time between SYNC0 event and reading of the inputs (in ns, only DC mode)	UINT32	RO	0x00000000 (0 _{dec})
1C33:04	Sync modes supported	Supported synchronization modes: <ul style="list-style-type: none"> • Bit 0: free run is supported • Bit 1: synchronous with SM 2 event is supported (outputs available) • Bit 1: synchronous with SM 3 event is supported (no outputs available) • Bit 2-3 = 01: DC mode is supported • Bit 4-5 = 01: input shift through local event (outputs available) • Bit 4-5 = 10: input shift with SYNC1 event (no outputs available) • Bit 14 = 1: dynamic times (measurement through writing of 0x1C33:08) 	UINT16	RO	0xC003 (49155 _{dec})
1C33:05	Minimum cycle time	Minimum cycle time (in ns)	UINT32	RO	0x0000FDE8 (65000 _{dec})
1C33:06	Calc and copy time	Time between reading of the inputs and availability of the inputs for the master (in ns, only DC mode)	UINT32	RO	0x00000000 (0 _{dec})
1C33:07	Minimum delay time		UINT32	RO	0x00000000 (0 _{dec})
1C33:08	Get cycle time	With this entry the real required process data provision time can be measured. <ul style="list-style-type: none"> • 0: Measurement of the local cycle time is stopped • 1: Measurement of the local cycle time is started The entries 0x1C33:03, 0x1C33:06, 1C33:09 are updated with the maximum measured values. For a subsequent measurement the measured values are reset.	UINT16	RW	0x0000 (0 _{dec})
1C33:09	Maximum delay time	Time between SYNC1 event and reading of the inputs (in ns, only DC mode)	UINT32	RO	0x00000000 (0 _{dec})
1C33:0B	SM event missed counter	Number of missed SM events in OPERATIONAL (DC mode only)	UINT16	RO	0x0000 (0 _{dec})
1C33:0C	Cycle exceeded counter	Number of occasions the cycle time was exceeded in OPERATIONAL (cycle was not completed in time or the next cycle began too early)	UINT16	RO	0x0000 (0 _{dec})
1C33:0D	Shift too short counter	Number of occasions that the interval between SYNC0 and SYNC1 event was too short (DC mode only)	UINT16	RO	0x0000 (0 _{dec})
1C33:20	Sync error	The synchronization was not correct in the last cycle (outputs were output too late; DC mode only)	BOOLEAN	RO	0x00 (0 _{dec})

Index F009 password protection

Index (hex)	Name	Meaning	Data type	Flags	Default
F009:0	Password protection ▶ 259]	Password protection for user calibration	UINT32	RW	0x00000000 (0 _{dec})

5.6.3.2 EL3122

5.6.3.2.1 Restore object

Index 1011 Restore default parameters

Index (hex)	Name	Meaning	Data type	Flags	Default
1011:0	Restore default parameters ▶ 503	Restore default parameters	UINT8	RO	0x01 (1 _{dec})
1011:01	SubIndex 001	If this object is set to “0x64616F6C” in the set value dialog, all backup objects are reset to their delivery state.	UINT32	RW	0x00000000 (0 _{dec})

5.6.3.2.2 Configuration data

Index 40n0* producer code word (for n = 4 [channel 1], n = 8 [channel 2])

● Producer code word

i The vendor reserves the authority for the basic calibration of the terminals. The Producer code word is therefore at present reserved.

*) up to rev. no. EL31x2-0000-0016, only for EL31x2, see [note regarding EL31x2 terminals before rev. no. EL31x2-0000-0016 ▶ 278](#)

Index 40n1 ADC raw value (for n = 4 [channel 1], n = 8 [channel 2])

(up to rev. no. EL31x2-0000-0016, only for EL31x2, see [note ▶ 278](#))

Index (hex)	Name	Meaning	Flags	Default
40n1:0	ADC raw value	Length of this object	RO	1 _{dec}
40n1:01	ADC rawdata	This is the circuit's raw ADC value. It is converted to a measurement through a calculation with the gain and offset from the calibration.	RO	-

Index 40n1 feature bits (for n = 6 [channel 1], n = A [channel 2])

(up to rev. no. EL31x2-0000-0016, only for EL31x2, see [note ▶ 278](#))

Index (hex)	Name	Meaning	Flags	Default	
40n1:0	Feature bits	Length of this object	RW	3 _{dec}	
40n1:01	Enable user scale	TRUE	User scaling (index 40n2 ▶ 342) is active.	RW	FALSE
		FALSE	The user scaling is deactivated.		
40n1:02	Enable absolute with MSB as sign	TRUE	The measured value is output in magnitude-sign format.	RW	FALSE
			EL3102		
		EL3142-0010	+10 mA = 0x7FFF -10 mA = 0xFFFF		
		FALSE	The measured value is output as signed integer in the two's complement		
EL3142-0010	+10 mA = 0x7FFF -10 mA = 0x8001				
40n1:03	Enable filter	TRUE	The digital filter (index 40n5 ▶ 342 , filter settings) is active. The analog values are not converted synchronously with the exchange of process data, but in accordance with the filter setting.	RW	FALSE
		FALSE	The analog values are converted synchronously with the exchange of process data; a digital filter is not active.		

Index 40n2 calibration data (for n = 4 [channel 1], n = 8 [channel 2])

(up to rev. no. EL31x2-0000-0016, only for EL31x2, see [note ▶ 278](#))

Index (hex)	Name	Meaning	Flags	Default	
40n2:0	Calibration data	Length of this object	RW	2 _{dec}	
40n2:01	Offset 16 bit signed integer	These objects are used to trim the tolerances of the components to determine the measured value. The values can only be changed if the producer code word is set (index 40n0 [▶ 341]).	Offset trim channel 1/ channel 2	RW	0xXXXX
40n2:02	Gain 16 bit unsigned integer		Gain trim channel 1/ channel 2	RW	0xXXXX

**Index 40n2 user scale (for n = 4 [channel 1], n = A [channel 2])
(Feature bit 40n1:01 enabled) 40n1:01 [▶ 341]**

(up to rev. no. EL31x2-0000-0016, only for EL31x2, see note [▶ 278])

Index (hex)	Name	Meaning	Flags	Default	
40n2:0	User scale	Length of this object	RW	2 _{dec}	
40n2:01	Offset 16 bit signed integer	These objects contain the user scaling.	Offset trim, user scaling channel 1/ channel 2	RW	0x0000
40n2:02	Gain 32 bit signed integer	The scaling is enabled via 40n1:01 [▶ 341].	Gain trim, user scaling channel 1/ channel 2 The gain is represented in fixed-point format, with the factor 2 ⁻¹⁶ . A value of 1 for the gain factor therefore corresponds to 65536 _{dec} (0x00010000).	RW	0x00010000

**Index 40n5 filter settings (for n = 4 [channel 1], n = A [channel 2])
(Feature bit 40n1:03 enabled) 40n1:03 [▶ 341]**

(up to rev. no. EL31x2-0000-0016, only for EL31x2, see note [▶ 278])

Enum value	Decimal value	Description	Default
50 Hz FIR	0	50 Hz FIR over 32 values; 50 Hz interferences are suppressed with 60 dB	50 Hz FIR (0 _{dec})
60 Hz FIR	1	60 Hz FIR over 32 values; 60 Hz interferences are suppressed with 40 dB	
IIR Level 1	2	Recursive filter, t _{rise_90%} ** = 0.72 ms	
IIR Level 2	3	Recursive filter, t _{rise_90%} = 1.62 ms	
IIR Level 3	4	Recursive filter, t _{rise_90%} = 3.24 ms	
IIR Level 4	5	Recursive filter, t _{rise_90%} = 6.48 ms	
IIR Level 5	6	Recursive filter, t _{rise_90%} = 12.96 ms	
IIR Level 6	7	Recursive filter, t _{rise_90%} = 25.92 ms	
IIR Level 7	8	Recursive filter, t _{rise_90%} = 51.84 ms	
IIR Level 8	9	Recursive filter, t _{rise_90%} = 103.68 ms	

**) step in rise time [t_{rise_90%}]

Index 80n0*** AI settings (for $0 \leq n \leq 1$)

Index (hex)	Name	Meaning	Data type	Flags	Default
80n0:0	AI Settings	Maximum subindex	UINT8	RO	0x18 (24 _{dec})
80n0:01	Enable user scale [▶ 269]	User scale is active.	BOOLEAN	RW	0x00 (0 _{dec})
80n0:02	Presentation [▶ 244]	0: Signed presentation 1: Unsigned presentation 2: Absolute value with MSB as sign Signed amount representation	BIT3	RW	0x00 (0 _{dec})
80n0:05	Siemens bits [▶ 246]	The S5 bits are displayed in the three low-order bits	BOOLEAN	RW	0x00 (0 _{dec})
80n0:06	Enable filter	Enable filter, which makes PLC-cycle-synchronous data exchange unnecessary	BOOLEAN	RW	0x00 (0 _{dec})
80n0:07	Enable limit 1 [▶ 246]	Limit 1 enabled	BOOLEAN	RW	0x00 (0 _{dec})
80n0:08	Enable limit 2 [▶ 246]	Limit 2 enabled	BOOLEAN	RW	0x00 (0 _{dec})
80n0:0A	Enable user calibration [▶ 269]	Enabling of the user calibration	BOOLEAN	RW	0x00 (0 _{dec})
80n0:0B	Enable vendor calibration [▶ 269]	Enabling of the vendor calibration	BOOLEAN	RW	0x01 (1 _{dec})
80n0:0E	Swap limit bits [▶ 247]	Changing of the Limit Bits	BOOLEAN	RW	0x00 (0 _{dec})
80n0:11	User scale offset [▶ 269]	User scaling offset	INT16	RW	0x0000 (0 _{dec})
80n0:12	User scale gain [▶ 269]	User scaling gain. The gain is represented in fixed-point format, with the factor 2^{-16} . The value 1 corresponds to 65536 _{dec} (0x00010000) and is limited to $\pm 0x7FFF$	INT32	RW	0x00010000 (65536 _{dec})
80n0:13	Limit 1 [▶ 246]	First limit value for setting the status bits	INT16	RW	0x0000 (0 _{dec})
80n0:14	Limit 2 [▶ 246]	Second limit value for setting the status bits	INT16	RW	0x0000 (0 _{dec})
80n0:15	Filter settings	This object determines the digital filter settings, if it is active via Enable filter (index 0x80n0:06 [▶ 343]). The possible settings are sequentially numbered. 0: 50 Hz FIR 1: 60 Hz FIR 2: IIR 1 3: IIR 2 4: IIR 3 5: IIR 4 6: IIR 5 7: IIR 6 8: IIR 7 9: IIR 8	UINT16	RW	0x0000 (0 _{dec})
80n0:17	User calibration offset [▶ 269]	User offset compensation	INT16	RW	0x0000 (0 _{dec})
80n0:18	User calibration gain [▶ 269]	User calibration gain	INT16	RW	0x4000 (16384 _{dec})

***) since revision no. EL31xx-00xx-0016



The filter characteristics are set via index 0x8000:15 [▶ 343]

The filter frequencies are set for all channels of the EL31xx terminals centrally via index 0x8000:15 [▶ 343] (channel 1). All other corresponding indices 0x80n0:15 have no parameterization function!

5.6.3.2.3 Profile-specific objects (0x6000-0xFFFF)

The profile-specific objects have the same meaning for all EtherCAT slaves that support the profile 5001.

5.6.3.2.3.1 Input data

Index 3101 inputs (channel 1)

(up to rev. no. EL31x2-0000-0016, only for EL31x2, see [note \[► 278\]](#))

Index (hex)	Name	Meaning	Flags	Default
3101:0	Inputs	Length of this object	RO	2 _{dec}
3101:01	Status	Status byte [► 254] channel 1	RO	-
3101:02	Value	Input process data channel 1	RO	-

Index 3102 inputs (channel 2)

(up to rev. no. EL31x2-0000-0016, only for EL31x2, see [note \[► 278\]](#))

Index (hex)	Name	Meaning	Flags	Default
3102:0	Inputs	Length of this object	RO	2 _{dec}
3102:01	Status	Status byte [► 254] channel 2	RO	-
3102:02	Value	Input process data channel 2	RO	-

Index 60n0*** AI inputs (for 0 ≤ n ≤ 1)

Index (hex)	Name	Meaning	Data type	Flags	Default
60n0:0	AI inputs	Maximum subindex	INT16	RO	0x11 (17 _{dec})
60n0:01	Underrange	Value below measuring range.	BOOLEAN	RO	0x00 (0 _{dec})
60n0:02	Overrange	Measuring range exceeded.	BOOLEAN	RO	0x00 (0 _{dec})
60n0:03	Limit 1	Limit value monitoring Limit 1 0: not active 1: value is smaller than limit value 1 2: value is larger than limit value 1 3: Value is equal to limit value 1	BIT2	RO	0x00 (0 _{dec})
60n0:05	Limit 2	Limit value monitoring limit 2 0: not active 1: value is smaller than limit value 2 2: value is larger than limit value 2 3: Value is equal to limit value 2	BIT2	RO	0x00 (0 _{dec})
60n0:07	Error	The error bit is set if the data is invalid (over-range, under-range)	BOOLEAN	RO	0x00 (0 _{dec})
60n0:0E	Sync error	The Sync error bit is only required for DC mode. It indicates whether a synchronization error has occurred during the previous cycle. This means a SYNC signal was triggered in the EL31xx, although no new process data were available (0=OK, 1=NOK).	BOOLEAN	RO	0x00 (0 _{dec})
60n0:0F	TxPDO State	Validity of the data of the associated TxPDO (0 = valid, 1 = invalid).	BOOLEAN	RO	0x00 (0 _{dec})
60n0:10	TxPDO Toggle	The TxPDO toggle is toggled by the slave when the data of the associated TxPDO is updated.	BOOLEAN	RO	0x00 (0 _{dec})
60n0:11	Value	Analog input date	INT16	RO	0x0000 (0 _{dec})

***) since revision no. EL31xx-00xx-0016

Index 6401 inputs (channels 1 & 2)

(up to rev. no. EL31x2-0000-0016, only for EL31x2, see [note \[► 278\]](#))

Index (hex)	Name	Meaning	Flags	Default
6401:0	Inputs	Length of this object	RO	2 _{dec}
6401:01	Value channel 1	Input process data channel 1	RO	-
6401:02	Value channel 2	Input process data channel 2	RO	-

5.6.3.2.3.2 Configuration data (vendor-specific)

Index 80nF*** AI vendor data (for $0 \leq n \leq 1$)

Index (hex)	Name	Meaning	Data type	Flags	Default
80nF:0	AI vendor data	Maximum subindex	UINT8	RO	0x02 (2 _{dec})
80nF:01	Calibration offset	Offset (vendor calibration)	INT16	RW	0x0000 (0 _{dec})
80nF:02	Calibration gain	Gain (vendor calibration)	INT16	RW	0x4000 (16384 _{dec})

***) since revision no. EL31xx-00xx-0016

5.6.3.2.3.3 Information and diagnostic data

Index 80nE*** AI internal data (for $0 \leq n \leq 1$)

Index (hex)	Name	Meaning	Data type	Flags	Default
80nE:0	AI internal data	Maximum subindex	UINT8	RO	0x01 (1 _{dec})
80nE:01	ADC raw value	ADC raw value	UINT16	RO	-

***) since revision no. EL31xx-00xx-0016

Index F000*** Modular device profile

Index (hex)	Name	Meaning	Data type	Flags	Default
F000:0	Modular device profile	General information for the modular device profile	UINT8	RO	0x02 (2 _{dec})
F000:01	Module index distance	Index spacing of the objects of the individual channels	UINT16	RO	0x0010 (16 _{dec})
F000:02	Maximum number of modules	Number of channels	UINT16	RO	Max. Channels number of the terminal

***) since revision no. EL31xx-00xx-0016

Index F008*** Code word

Index	Name	Meaning	Data type	Flags	Default
F008:0	Code word	reserved	UINT32	RW	0x00000000 (0 _{dec})

***) since revision no. EL31xx-00xx-0016

Index F009*** Password protection

Index (hex)	Name	Meaning	Data type	Flags	Default
F009:0	Password protection	Password protection user calibration [► 259]	UINT32	RW	0x00000000 (0 _{dec})

***) for EL31xx, see [note \[► 259\]](#)

Index F010*** module list (for $1 \leq n \leq 4$, depends on number of channels)

Index (hex)	Name	Meaning	Data type	Flags	Default
F010:0	Module list	Maximum subindex	UINT8	RW	0x0n
F010:0n	SubIndex 00n	Analog input profile (300)	UINT32	RW	0x0000012C (300 _{dec})

***) since revision no. EL31xx-00xx-0016

5.6.3.2.4 Standard objects

Standard objects (0x1000-0x1FFF)

The standard objects have the same meaning for all EtherCAT slaves.

Index 1000 Device type

Index (hex)	Name	Meaning	Data type	Flags	Default
1000:0	Device type	Device type of the EtherCAT slave: the Lo-Word contains the CoE profile used (5001). The Hi-Word contains the module profile according to the modular device profile.	UINT32	RO	0x00001389 (5001 _{dec})

Index 1008 Device name

Index (hex)	Name	Meaning	Data type	Flags	Default
1008:0	Device name	Device name of the EtherCAT slave	STRING	RO	EL31xx

Index 1009 Hardware version

Index (hex)	Name	Meaning	Data type	Flags	Default
1009:0	Hardware version	Hardware version of the EtherCAT slave	STRING	RO	00

Index 100A Software version

Index (hex)	Name	Meaning	Data type	Flags	Default
100A:0	Software version	Firmware version of the EtherCAT slave	STRING	RO	-

Index 1018 Identity

Index (hex)	Name	Meaning	Data type	Flags	Default
1018:0	Identity	Information for identifying the slave	UINT8	RO	0x04 (4 _{dec})
1018:01	Vendor ID	Vendor ID of the EtherCAT slave	UINT32	RO	0x00000002 (2 _{dec})
1018:02	Product code	Product code of the EtherCAT slave	UINT32	RO	0xFFFF3052
1018:03	Revision	Revision number of the EtherCAT slave; the low word (bit 0-15) indicates the special terminal number, the high word (bit 16-31) refers to the device description	UINT32	RO	-
1018:04	Serial number	Serial number of the EtherCAT slave; the low byte (bit 0-7) of the low word contains the year of production, the high byte (bit 8-15) of the low word contains the week of production, the high word (bit 16-31) is 0	UINT32	RO	-

Index 10F0*** Backup parameter handling

Index (hex)	Name	Meaning	Data type	Flags	Default
10F0:0	Backup parameter handling	Information for standardized loading and saving of backup entries	UINT8	RO	0x01 (1 _{dec})
10F0:01	Checksum	Checksum across all backup entries of the EtherCAT slave	UINT32	RO	-

***) since revision no. EL31xx-00xx-0016

Index 1800 TxPDO-Par Ch.1

Index (hex)	Name	Meaning	Data type	Flags	Default
1800:0	TxPDO-Par Ch.1	PDO Parameter TxPDO	UINT8	RO	0x06 (6 _{dec})
1800:06	Exclude TxPDOs	Hier sind die TxPDOs (Index der TxPDO Mapping Objekte) angegeben, die nicht zusammen mit TxPDO 1 übertragen werden dürfen	OCTET-STRING[2]	RO	02 1A 03 1A 07 1A 10 1A

Index 1801 TxPDO-Par Ch.2

Index (hex)	Name	Meaning	Data type	Flags	Default
1801:0	TxPDO-Par Ch.2	PDO Parameter TxPDO	UINT8	RO	0x06 (6 _{dec})
1801:06	Exclude TxPDOs	Hier sind die TxPDOs (Index der TxPDO Mapping Objekte) angegeben, die nicht zusammen mit TxPDO 2 übertragen werden dürfen	OCTET-STRING[2]	RO	04 1A 05 1A 09 1A 10 1A

Index 1802 AI TxPDO-Par Standard Ch.2

Index (hex)	Name	Meaning	Data type	Flags	Default
1802:0	AI TxPDO-Par Standard Ch.2	PDO parameter TxPDO 3	UINT8	RO	0x06 (6 _{dec})
1802:06	Exclude TxPDOs	Specifies the TxPDOs (index of TxPDO mapping objects) that must not be transferred together with TxPDO 3	OCTET-STRING[2]	RO	03 1A

Index 1803 AI TxPDO-Par Compact Ch.1

Index (hex)	Name	Meaning	Data type	Flags	Default
1803:0	AI TxPDO-Par Compact Ch.1	PDO Parameter TxPDO	UINT8	RO	0x06 (6 _{dec})
1803:06	Exclude TxPDOs	Hier sind die TxPDOs (Index der TxPDO Mapping Objekte) angegeben, die nicht zusammen mit TxPDO 2 übertragen werden dürfen	OCTET-STRING[2]	RO	00 1A 02 1A 07 1A 10 1A

Index 1804 AI TxPDO-Par Standard Ch.2

Index (hex)	Name	Meaning	Data type	Flags	Default
1804:0	AI TxPDO-Par Standard Ch.2	PDO Parameter TxPDO	UINT8	RO	0x06 (6 _{dec})
1804:06	Exclude TxPDOs	Hier sind die TxPDOs (Index der TxPDO Mapping Objekte) angegeben, die nicht zusammen mit TxPDO 3 übertragen werden dürfen	OCTET-STRING[2]	RO	00 1A 05 1A 09 1A 10 1A

Index 1805 AI TxPDO-Par Compact Ch.2

Index (hex)	Name	Meaning	Data type	Flags	Default
1805:0	AI TxPDO-Par Compact Ch.2	PDO Parameter TxPDO	UINT8	RO	0x06 (6 _{dec})
1805:06	Exclude TxPDOs	Hier sind die TxPDOs (Index der TxPDO Mapping Objekte) angegeben, die nicht zusammen mit TxPDO 4 übertragen werden dürfen	OCTET-STRING[2]	RO	00 1A 04 1A 09 1A 10 1A

Index 1810 TxPDO-Par Channels

Index (hex)	Name	Meaning	Data type	Flags	Default
1810:0	TxPDO-Par Channels	PDO Parameter TxPDO	UINT8	RO	0x06 (6 _{dec})
1810:06	Exclude TxPDOs	Hier sind die TxPDOs (Index der TxPDO Mapping Objekte) angegeben, die nicht zusammen mit TxPDO 1 übertragen werden dürfen	OCTET-STRING[2]	RO	00 1A 01 1A 02 1A 03 1A 04 1A 05 1A 07 1A 09 1A

Index 1A00 TxPDO-Par Channel 1 (only for EL31x2)

Index (hex)	Name	Meaning	Data type	Flags	Default
1A0n:0	TxPDO Map Ch. 1	PDO Mapping TxPDO Ch. 1	UINT8	RO	0x02 (2 _{dec})
1A00:01	SubIndex 001	1. PDO Mapping entry (object 0x3101 (Inputs), entry 0x01 (Inputs))	UINT32	RO	0x3101:01, 1
1A00:02	SubIndex 002	2. PDO Mapping entry (object 0x3101 (Inputs), entry 0x02 (Inputs))	UINT32	RO	0x3101:02, 1

Index 1A01 TxPDO-Par Channel 2 (only for EL31x2)

Index (hex)	Name	Meaning	Data type	Flags	Default
1A01:0	TxPDO Map Ch. 1	PDO Mapping TxPDO Ch. 1	UINT8	RO	0x02 (2 _{dec})
1A01:01	SubIndex 001	1. PDO Mapping entry (object 0x3102 (Inputs), entry 0x01 (Inputs))	UINT32	RO	0x3102:01, 1
1A01:02	SubIndex 002	2. PDO Mapping entry (object 0x3102 (Inputs), entry 0x02 (Inputs))	UINT32	RO	0x3102:02, 1

Index 1A02 AI TxPDO-Map Standard Ch.1

Index (hex)	Name	Meaning	Data type	Flags	Default
1A02:0	AI TxPDO-Map Standard Ch.1	PDO Mapping TxPDO	UINT8	RO	0x0B (11 _{dec})
1A02:01	SubIndex 001	1. PDO Mapping entry (object 0x6000 (AI Inputs), entry 0x01 (Underrange))	UINT32	RO	0x6000:01, 1
1A02:02	SubIndex 002	2. PDO Mapping entry (object 0x6000 (AI Inputs), entry 0x02 (Overrange))	UINT32	RO	0x6000:02, 1
1A02:03	SubIndex 003	3. PDO Mapping entry (object 0x6000 (AI Inputs), entry 0x03 (Limit 1))	UINT32	RO	0x6000:03, 2
1A02:04	SubIndex 004	4. PDO Mapping entry (object 0x6000 (AI Inputs), entry 0x05 (Limit 2))	UINT32	RO	0x6000:05, 2
1A02:05	SubIndex 005	5. PDO Mapping entry (object 0x6000 (AI Inputs), entry 0x07 (Error))	UINT32	RO	0x6000:07, 1
1A02:06	SubIndex 006	6. PDO Mapping entry (1 bit align)	UINT32	RO	0x0000:00, 1
1A02:07	SubIndex 007	7. PDO Mapping entry (5 bits align)	UINT32	RO	0x0000:00, 5
1A02:08	SubIndex 008	8. PDO Mapping entry (object 0x6000 (AI Inputs), entry 0x0E (Sync Error))	UINT32	RO	0x6000:0E, 1
1A02:09	SubIndex 009	9. PDO Mapping entry (object 0x6000 (AI Inputs), entry 0x0F (TxPDO State))	UINT32	RO	0x6000:0F, 1
1A02:0A	SubIndex 010	10. PDO Mapping entry (object 0x6000 (AI Inputs), entry 0x10 (TxPDO Toggle))	UINT32	RO	0x6000:10, 1
1A02:0B	SubIndex 011	11. PDO Mapping entry (object 0x6000 (AI Inputs), entry 0x11 (Value))	UINT32	RO	0x6000:11, 16

Index 1A03 AI TxPDO-Map Compact Ch.1

Index (hex)	Name	Meaning	Data type	Flags	Default
1A03:0	AI TxPDO-Map Compact Ch.1	PDO Mapping TxPDO	UINT8	RO	0x01 (1 _{dec})
1A03:01	SubIndex 001	1. PDO Mapping entry (object 0x6000 (AI Inputs), entry 0x11 (Value))	UINT32	RO	0x6000:11, 16

Index 1A04 AI TxPDO-Map Standard Ch.2

Index (hex)	Name	Meaning	Data type	Flags	Default
1A04:0	AI TxPDO-Map Standard Ch.2	PDO Mapping TxPDO	UINT8	RO	0x0B (1 _{dec})
1A04:01	SubIndex 001	1. PDO Mapping entry (object 0x6010 (AI Inputs), entry 0x01 (Underrange))	UINT32	RO	0x6010:01, 1
1A04:02	SubIndex 002	2. PDO Mapping entry (object 0x6010 (AI Inputs), entry 0x02 (Overrange))	UINT32	RO	0x6010:02, 1
1A04:03	SubIndex 003	3. PDO Mapping entry (object 0x6010 (AI Inputs), entry 0x03 (Limit 1))	UINT32	RO	0x6010:03, 2
1A04:04	SubIndex 004	4. PDO Mapping entry (object 0x6010 (AI Inputs), entry 0x05 (Limit 2))	UINT32	RO	0x6010:05, 2
1A04:05	SubIndex 005	5. PDO Mapping entry (object 0x6010 (AI Inputs), entry 0x07 (Error))	UINT32	RO	0x6010:07, 1
1A04:06	SubIndex 006	6. PDO Mapping entry (1 bit align)	UINT32	RO	0x0000:00, 1
1A04:07	SubIndex 007	7. PDO Mapping entry (5 bits align)	UINT32	RO	0x0000:00, 5
1A04:08	SubIndex 008	8. PDO Mapping entry (object 0x6010 (AI Inputs), entry 0x0E (Sync Error))	UINT32	RO	0x6010:0E, 1
1A04:09	SubIndex 009	9. PDO Mapping entry (object 0x6010 (AI Inputs), entry 0x0F (TxPDO State))	UINT32	RO	0x6010:0F, 1
1A04:0A	SubIndex 010	10. PDO Mapping entry (object 0x6010 (AI Inputs), entry 0x10 (TxPDO Toggle))	UINT32	RO	0x6010:10, 1
1A04:0B	SubIndex 011	11. PDO Mapping entry (object 0x6010 (AI Inputs), entry 0x11 (Value))	UINT32	RO	0x6010:11, 16

Index 1A05 AI TxPDO-Map Compact Ch.2

Index (hex)	Name	Meaning	Data type	Flags	Default
1A05:0	AI TxPDO-Map Compact Ch.2	PDO Mapping TxPDO	UINT8	RO	0x01 (1 _{dec})
1A05:01	SubIndex 001	1. PDO Mapping entry (object 0x6010 (AI Inputs), entry 0x11 (Value))	UINT32	RO	0x6010:11, 16

Index 1A10 TxPDO-Map Channels

Index (hex)	Name	Meaning	Data type	Flags	Default
1A10:0	TxPDO-Map Channels	PDO Mapping TxPDO	UINT8	RO	0x02 (2 _{dec})
1A10:01	SubIndex 001	1. PDO Mapping entry (object 0x3101 (Inputs), entry 0x01 (Inputs))	UINT32	RO	0x3101:02, 16
1A10:02	SubIndex 002	2. PDO Mapping entry (object 0x3101 (Inputs), entry 0x02 (Inputs))	UINT32	RO	0x3101:02, 16

Index 1C00 Sync manager type

Index (hex)	Name	Meaning	Data type	Flags	Default
1C00:0	Sync manager type	Using the sync managers	UINT8	RO	0x04 (4 _{dec})
1C00:01	SubIndex 001	Sync-Manager Type Channel 1: Mailbox Write	UINT8	RO	0x01 (1 _{dec})
1C00:02	SubIndex 002	Sync-Manager Type Channel 2: Mailbox Read	UINT8	RO	0x02 (2 _{dec})
1C00:03	SubIndex 003	Sync-Manager Type Channel 3: Process Data Write (Outputs)	UINT8	RO	0x03 (3 _{dec})
1C00:04	SubIndex 004	Sync-Manager Type Channel 4: Process Data Read (Inputs)	UINT8	RO	0x04 (4 _{dec})

Index 1C12 RxPDO assign

Index (hex)	Name	Meaning	Data type	Flags	Default
1C12:0	RxPDO assign	PDO Assign Outputs	UINT8	RW	0x00 (0 _{dec})

Index 1C13 TxPDO assign (only for EL31x2 before rev. EL31x2-0000-0016)

For operation on masters other than TwinCAT it must be ensured that the channels are entered in the PDO assignment ("TxPDO assign", object 0x1C13) successively.

Index (hex)	Name	Meaning	Data type	Flags	Default
1C13:0	TxPDO assign	PDO Assign Inputs	UINT8	RW	0x02 (2 _{dec})
1C13:01	SubIndex 001	1. allocated TxPDO (contains the index of the associated TxPDO mapping object)	UINT16	RW	0x1A02
1C13:02	SubIndex 002	2. allocated TxPDO (contains the index of the associated TxPDO mapping object)	UINT16	RW	0x1A04

Index 1C13 TxPDO assign (only for EL31x2 from rev. EL31x2-0000-0016)

For operation on masters other than TwinCAT it must be ensured that the channels are entered in the PDO assignment ("TxPDO assign", object 0x1C13) successively.

Index (hex)	Name	Meaning	Data type	Flags	Default
1C13:0	TxPDO assign	PDO Assign Inputs	UINT8	RW	0x02 (2 _{dec})
1C13:01	SubIndex 001	1. allocated TxPDO (contains the index of the associated TxPDO mapping object)	UINT16	RW	0x1A00
1C13:02	SubIndex 002	2. allocated TxPDO (contains the index of the associated TxPDO mapping object)	UINT16	RW	0x1A01

Index 1C33* SM input parameter**

Index (hex)	Name	Meaning	Data type	Flags	Default
1C33:0	SM input parameter	Synchronization parameters for the inputs	UINT8	RO	0x20 (32 _{dec})
1C33:01	Sync mode	Current synchronization mode: <ul style="list-style-type: none"> • Bit 0 = 0: Free Run • Bit 0 = 1: Synchronous with SM 3 event • Bit 0-1 = 11: DC with SYNC1 event • Bit 15 = 1: Fast mode 	UINT16	RW	0x0022 (34 _{dec})
1C33:02	Cycle time	Cycle time (in ns): <ul style="list-style-type: none"> • Free Run: Cycle time of the local timer • Synchronous with SM 2 event: Master cycle time • DC mode: SYNC0/SYNC1 Cycle Time 	UINT32	RW	0x000F4240 (1000000 _{dec})
1C33:03	Shift time	Time between SYNC0 event and reading of the inputs (in ns, only DC mode)	UINT32	RO	0x000186A0 (100000 _{dec})
1C33:04	Sync modes supported	Supported synchronization modes: <ul style="list-style-type: none"> • Bit 0 = 1: Free Run is supported • Bit 1: Synchron with SM 3 Event is supported (no Outputs available) • Bit 2 = 1: DC mode (SYNC0) • Bit 3 = 1: DC mode (SYNC1) • Bit 4-5 = 01: Input Shift with local event (Outputs available) • Bit 4-5 = 10: Input Shift with SYNC1 Event (no Outputs available) • Bit 12 = 1: Legacy Synchron • Bit 13 = 1: SM event • Bit 14 = 1: dynamic times (measure by writing 1C33:08 [▶ 351]) • Bit 15 = 1: Fast mode 	UINT16	RO	0xD00B (53259 _{dec})
1C33:05	Minimum cycle time	Minimum cycle time (in ns)	UINT32	RO	0x000186A0 (100000 _{dec})
1C33:06	Calc and copy time	Time between reading of the inputs and availability of the inputs for the master (in ns, only DC mode)	UINT32	RO	0x00002710 (10000dez)
1C33:08	Command	With this entry the real required process data provision time can be measured. <ul style="list-style-type: none"> • 0: Measurement of the local cycle time is stopped • 1: Measurement of the local cycle time is started <p>The entries 1C33:03 [▶ 351], 1C33:06 [▶ 351], and 1C33:09 [▶ 351] are updated with the maximum measured values. For a subsequent measurement the measured values are reset</p>	UINT16	RW	0x0000 (0 _{dec})
1C33:09	Maximum Delay time	Time between SYNC1 event and reading of the inputs (in ns, only DC mode)	UINT32	RO	0x000186A0 (100000dez)
1C33:0B	SM event missed counter	Number of missed SM events in OPERATIONAL (DC mode only)	UINT16	RO	0x0000 (0 _{dec})
1C33:0C	Cycle exceeded counter	Number of occasions the cycle time was exceeded in OPERATIONAL (cycle was not completed in time or the next cycle began too early)	UINT16	RO	0x0000 (0 _{dec})
1C33:0D	Shift too short counter	Number of occasions that the interval between SYNC0 and SYNC1 event was too short (DC mode only)	UINT16	RO	0x0000 (0 _{dec})
1C33:20	Sync error	The synchronization was not correct in the last cycle (outputs were output too late; DC mode only)	BOOLEAN	RO	0x00 (0 _{dec})

***) since revision no. EL31xx-00xx-0016

Index F009* Password protection**

Index (hex)	Name	Meaning	Data type	Flags	Default
F009:0	Password protection	Password protection user calibration [▶ 259]	UINT32	RW	0x00000000 (0 _{dec})

***) for EL31xx, see [note \[▶ 259\]](#)

5.6.3.3 EL3124

5.6.3.3.1 Restore object

Index 1011 Restore default parameters

Index (hex)	Name	Meaning	Data type	Flags	Default
1011:0	Restore default parameters [▶ 503]	Restore default parameters	UINT8	RO	0x01 (1 _{dec})
1011:01	SubIndex 001	If this object is set to “0x64616F6C” in the set value dialog, all backup objects are reset to their delivery state.	UINT32	RW	0x00000000 (0 _{dec})

5.6.3.3.2 Configuration data

Index 80n0*** AI settings (for 0 ≤ n ≤ 3)

Index (hex)	Name	Meaning	Data type	Flags	Default
80n0:0	AI Settings	Maximum subindex	UINT8	RO	0x18 (24 _{dec})
80n0:01	Enable user scale [▶ 269]	User scale is active.	BOOLEAN	RW	0x00 (0 _{dec})
80n0:02	Presentation [▶ 244]	0: Signed presentation 1: Unsigned presentation 2: Absolute value with MSB as sign Signed amount representation	BIT3	RW	0x00 (0 _{dec})
80n0:05	Siemens bits [▶ 246]	The S5 bits are displayed in the three low-order bits	BOOLEAN	RW	0x00 (0 _{dec})
80n0:06	Enable filter	Enable filter, which makes PLC-cycle-synchronous data exchange unnecessary	BOOLEAN	RW	0x00 (0 _{dec})
80n0:07	Enable limit 1 [▶ 246]	Limit 1 enabled	BOOLEAN	RW	0x00 (0 _{dec})
80n0:08	Enable limit 2 [▶ 246]	Limit 2 enabled	BOOLEAN	RW	0x00 (0 _{dec})
80n0:0A	Enable user calibration [▶ 269]	Enabling of the user calibration	BOOLEAN	RW	0x00 (0 _{dec})
80n0:0B	Enable vendor calibration [▶ 269]	Enabling of the vendor calibration	BOOLEAN	RW	0x01 (1 _{dec})
80n0:0E	Swap limit bits [▶ 247]	Changing of the Limit Bits	BOOLEAN	RW	0x00 (0 _{dec})
80n0:11	User scale offset [▶ 269]	User scaling offset	INT16	RW	0x0000 (0 _{dec})
80n0:12	User scale gain [▶ 269]	User scaling gain. The gain is represented in fixed-point format, with the factor 2 ⁻¹⁶ . The value 1 corresponds to 65536 _{dec} (0x00010000) and is limited to ±0x7FFFF	INT32	RW	0x00010000 (65536 _{dec})
80n0:13	Limit 1 [▶ 246]	First limit value for setting the status bits	INT16	RW	0x0000 (0 _{dec})
80n0:14	Limit 2 [▶ 246]	Second limit value for setting the status bits	INT16	RW	0x0000 (0 _{dec})
80n0:15	Filter settings	This object determines the digital filter settings, if it is active via Enable filter (index 0x80n0:06 [▶ 353]). The possible settings are sequentially numbered. 0: 50 Hz FIR 1: 60 Hz FIR 2: IIR 1 3: IIR 2 4: IIR 3 5: IIR 4 6: IIR 5 7: IIR 6 8: IIR 7 9: IIR 8	UINT16	RW	0x0000 (0 _{dec})
80n0:17	User calibration offset [▶ 269]	User offset compensation	INT16	RW	0x0000 (0 _{dec})
80n0:18	User calibration gain [▶ 269]	User calibration gain	INT16	RW	0x4000 (16384 _{dec})

***) since revision no. EL31xx-00xx-0016

Filter

The filters of the EL30xx/EL31xx are activated or deactivated via the CoE index 0x8000:15.

i The filter characteristics are set via index 0x8000:15

The filter frequencies are set for all channels of the EL30xx/EL31xx terminals centrally via index 0x8000:15 (channel 1). All other corresponding indices 0x80n0:15 have no parameterization function! The latest firmware version (see [status table](#) [▶ 484]) returns an EtherCAT-compliant error message, if the filter characteristics of other channels (index 0x80n0:06, 0x80n0:15) are set.

5.6.3.3.3 Profile-specific objects (0x6000-0xFFFF)

The profile-specific objects have the same meaning for all EtherCAT slaves that support the profile 5001.

5.6.3.3.3.1 Input data

Index 60n0*** AI inputs (for $0 \leq n \leq 3$)

Index (hex)	Name	Meaning	Data type	Flags	Default
60n0:0	AI inputs	Maximum subindex	INT16	RO	0x11 (17 _{dec})
60n0:01	Underrange	Value below measuring range.	BOOLEAN	RO	0x00 (0 _{dec})
60n0:02	Ovrange	Measuring range exceeded.	BOOLEAN	RO	0x00 (0 _{dec})
60n0:03	Limit 1	Limit value monitoring Limit 1 0: not active 1: value is smaller than limit value 1 2: value is larger than limit value 1 3: Value is equal to limit value 1	BIT2	RO	0x00 (0 _{dec})
60n0:05	Limit 2	Limit value monitoring limit 2 0: not active 1: value is smaller than limit value 2 2: value is larger than limit value 2 3: Value is equal to limit value 2	BIT2	RO	0x00 (0 _{dec})
60n0:07	Error	The error bit is set if the data is invalid (over-range, under-range)	BOOLEAN	RO	0x00 (0 _{dec})
60n0:0E	Sync error	The Sync error bit is only required for DC mode. It indicates whether a synchronization error has occurred during the previous cycle. This means a SYNC signal was triggered in the EL31xx, although no new process data were available (0=OK, 1=NOK).	BOOLEAN	RO	0x00 (0 _{dec})
60n0:0F	TxPDO State	Validity of the data of the associated TxPDO (0 = valid, 1 = invalid).	BOOLEAN	RO	0x00 (0 _{dec})
60n0:10	TxPDO Toggle	The TxPDO toggle is toggled by the slave when the data of the associated TxPDO is updated.	BOOLEAN	RO	0x00 (0 _{dec})
60n0:11	Value	Analog input date	INT16	RO	0x0000 (0 _{dec})

***) since revision no. EL31xx-00xx-0016

5.6.3.3.3.2 Configuration data (vendor-specific)

Index 80nF*** AI vendor data (for $0 \leq n \leq 3$)

Index (hex)	Name	Meaning	Data type	Flags	Default
80nF:0	AI vendor data	Maximum subindex	UINT8	RO	0x02 (2 _{dec})
80nF:01	Calibration offset	Offset (vendor calibration)	INT16	RW	0x0000 (0 _{dec})
80nF:02	Calibration gain	Gain (vendor calibration)	INT16	RW	0x4000 (16384 _{dec})

***) since revision no. EL31xx-00xx-0016

5.6.3.3.3 Information and diagnostic data

Index 80nE*** AI internal data (for $0 \leq n \leq 3$)

Index (hex)	Name	Meaning	Data type	Flags	Default
80nE:0	AI internal data	Maximum subindex	UINT8	RO	0x01 (1 _{dec})
80nE:01	ADC raw value	ADC raw value	UINT16	RO	-

***) since revision no. EL31xx-00xx-0016

Index F000*** Modular device profile

Index (hex)	Name	Meaning	Data type	Flags	Default
F000:0	Modular device profile	General information for the modular device profile	UINT8	RO	0x02 (2 _{dec})
F000:01	Module index distance	Index spacing of the objects of the individual channels	UINT16	RO	0x0010 (16 _{dec})
F000:02	Maximum number of modules	Number of channels	UINT16	RO	Max. Channels number of the terminal

***) since revision no. EL31xx-00xx-0016

Index F008*** Code word

Index	Name	Meaning	Data type	Flags	Default
F008:0	Code word	reserved	UINT32	RW	0x00000000 (0 _{dec})

***) since revision no. EL31xx-00xx-0016

Index F010*** module list (for $1 \leq n \leq 4$, depends on number of channels)

Index (hex)	Name	Meaning	Data type	Flags	Default
F010:0	Module list	Maximum subindex	UINT8	RW	0x0n
F010:0n	SubIndex 00n	Analog input profile (300)	UINT32	RW	0x0000012C (300 _{dec})

***) since revision no. EL31xx-00xx-0016

5.6.3.3.4 Standard objects

Standard objects (0x1000-0x1FFF)

The standard objects have the same meaning for all EtherCAT slaves.

Index 1000 Device type

Index (hex)	Name	Meaning	Data type	Flags	Default
1000:0	Device type	Device type of the EtherCAT slave: the Lo-Word contains the CoE profile used (5001). The Hi-Word contains the module profile according to the modular device profile.	UINT32	RO	0x012C1389 (19665801 _{dec})

Index 1008 Device name

Index (hex)	Name	Meaning	Data type	Flags	Default
1008:0	Device name	Device name of the EtherCAT slave	STRING	RO	EL31xx

Index 1009 Hardware version

Index (hex)	Name	Meaning	Data type	Flags	Default
1009:0	Hardware version	Hardware version of the EtherCAT slave	STRING	RO	00

Index 100A Software version

Index (hex)	Name	Meaning	Data type	Flags	Default
100A:0	Software version	Firmware version of the EtherCAT slave	STRING	RO	-

Index 1018 Identity

Index (hex)	Name	Meaning	Data type	Flags	Default
1018:0	Identity	Information for identifying the slave	UINT8	RO	0x04 (4 _{dec})
1018:01	Vendor ID	Vendor ID of the EtherCAT slave	UINT32	RO	0x00000002 (2 _{dec})
1018:02	Product code	Product code of the EtherCAT slave	UINT32	RO	0xFFFF3052
1018:03	Revision	Revision number of the EtherCAT slave; the low word (bit 0-15) indicates the special terminal number, the high word (bit 16-31) refers to the device description	UINT32	RO	-
1018:04	Serial number	Serial number of the EtherCAT slave; the low byte (bit 0-7) of the low word contains the year of production, the high byte (bit 8-15) of the low word contains the week of production, the high word (bit 16-31) is 0	UINT32	RO	-

Index 10F0* Backup parameter handling**

Index (hex)	Name	Meaning	Data type	Flags	Default
10F0:0	Backup parameter handling	Information for standardized loading and saving of backup entries	UINT8	RO	0x01 (1 _{dec})
10F0:01	Checksum	Checksum across all backup entries of the EtherCAT slave	UINT32	RO	-

***) since revision no. EL31xx-00xx-0016

Index 1800 AI TxPDO-Par Standard Ch.1

Index (hex)	Name	Meaning	Data type	Flags	Default
1800:0	AI TxPDO-Par Standard Ch.1	PDO parameter TxPDO 1	UINT8	RO	0x06 (6 _{dec})
1800:06	Exclude TxPDOs	Specifies the TxPDOs (index of TxPDO mapping objects) that must not be transferred together with TxPDO 1	OCTET-STRING[2]	RO	01 1A

Index 1801 AI TxPDO-Par Compact Ch.1

Index (hex)	Name	Meaning	Data type	Flags	Default
1801:0	AI TxPDO-Par Compact Ch.1	PDO parameter TxPDO 2	UINT8	RO	0x06 (6 _{dec})
1801:06	Exclude TxPDOs	Specifies the TxPDOs (index of TxPDO mapping objects) that must not be transferred together with TxPDO 2	OCTET-STRING[2]	RO	00 1A

Index 1802 AI TxPDO-Par Standard Ch.2

Index (hex)	Name	Meaning	Data type	Flags	Default
1802:0	AI TxPDO-Par Standard Ch.2	PDO parameter TxPDO 3	UINT8	RO	0x06 (6 _{dec})
1802:06	Exclude TxPDOs	Specifies the TxPDOs (index of TxPDO mapping objects) that must not be transferred together with TxPDO 3	OCTET-STRING[2]	RO	03 1A

Index 1803 AI TxPDO-Par Compact Ch. 2

Index (hex)	Name	Meaning	Data type	Flags	Default
1803:0	AI TxPDO-Par Compact Ch.2	PDO parameter TxPDO 4	UINT8	RO	0x06 (6 _{dec})
1803:06	Exclude TxPDOs	Specifies the TxPDOs (index of TxPDO mapping objects) that must not be transferred together with TxPDO 4	OCTET-STRING[2]	RO	02 1A

Index 1804 AI TxPDO-Par Standard Ch.3

Index (hex)	Name	Meaning	Data type	Flags	Default
1804:0	AI TxPDO-Par Standard Ch.3	PDO parameter TxPDO 5	UINT8	RO	0x06 (6 _{dec})
1804:06	Exclude TxPDOs	Specifies the TxPDOs (index of TxPDO mapping objects) that must not be transferred together with TxPDO 5	OCTET-STRING[2]	RO	05 1A

Index 1805 AI TxPDO-Par Compact Ch. 3

Index (hex)	Name	Meaning	Data type	Flags	Default
1805:0	AI TxPDO-Par Compact Ch.3	PDO parameter TxPDO 6	UINT8	RO	0x06 (6 _{dec})
1805:06	Exclude TxPDOs	Specifies the TxPDOs (index of TxPDO mapping objects) that must not be transferred together with TxPDO 6	OCTET-STRING[2]	RO	04 1A

Index 1806 AI TxPDO-Par Standard Ch.4

Index (hex)	Name	Meaning	Data type	Flags	Default
1806:0	AI TxPDO-Par Standard Ch.4	PDO parameter TxPDO 7	UINT8	RO	0x06 (6 _{dec})
1806:06	Exclude TxPDOs	Specifies the TxPDOs (index of TxPDO mapping objects) that must not be transferred together with TxPDO 7	OCTET-STRING[2]	RO	07 1A

Index 1807 AI TxPDO-Par Compact Ch. 4

Index (hex)	Name	Meaning	Data type	Flags	Default
1807:0	AI TxPDO-Par Compact Ch.4	PDO parameter TxPDO 8	UINT8	RO	0x06 (6 _{dec})
1807:06	Exclude TxPDOs	Specifies the TxPDOs (index of TxPDO mapping objects) that must not be transferred together with TxPDO 8	OCTET-STRING[2]	RO	06 1A

Index 1A00 AI TxPDO-Map Standard Ch.1

Index (hex)	Name	Meaning	Data type	Flags	Default
1A00:0	AI TxPDO-Map Standard Ch.1	PDO Mapping TxPDO	UINT8	RO	0x0B (11 _{dec})
1A00:01	SubIndex 001	1. PDO Mapping entry (object 0x6000 (AI Inputs), entry 0x01 (Underrange))	UINT32	RO	0x6000:01, 1
1A00:02	SubIndex 002	2. PDO Mapping entry (object 0x6000 (AI Inputs), entry 0x02 (Ovrrange))	UINT32	RO	0x6000:02, 1
1A00:03	SubIndex 003	3. PDO Mapping entry (object 0x6000 (AI Inputs), entry 0x03 (Limit 1))	UINT32	RO	0x6000:03, 2
1A00:04	SubIndex 004	4. PDO Mapping entry (object 0x6000 (AI Inputs), entry 0x05 (Limit 2))	UINT32	RO	0x6000:05, 2
1A00:05	SubIndex 005	5. PDO Mapping entry (object 0x6000 (AI Inputs), entry 0x07 (Error))	UINT32	RO	0x6000:07, 1
1A00:06	SubIndex 006	6. PDO Mapping entry (1 bit align)	UINT32	RO	0x0000:00, 1
1A00:07	SubIndex 007	7. PDO Mapping entry (5 bits align)	UINT32	RO	0x0000:00, 5
1A00:08	SubIndex 008	8. PDO Mapping entry (object 0x6000 (AI Inputs), entry 0x0E (Sync Error))	UINT32	RO	0x6000:0E, 1
1A00:09	SubIndex 009	9. PDO Mapping entry (object 0x6000 (AI Inputs), entry 0x0F (TxPDO State))	UINT32	RO	0x6000:0F, 1
1A00:0A	SubIndex 010	10. PDO Mapping entry (object 0x6000 (AI Inputs), entry 0x10 (TxPDO Toggle))	UINT32	RO	0x6000:10, 1
1A00:0B	SubIndex 011	11. PDO Mapping entry (object 0x6000 (AI Inputs), entry 0x11 (Value))	UINT32	RO	0x6000:11, 16

Index 1A01 AI TxPDO-Map Compact Ch.1

Index (hex)	Name	Meaning	Data type	Flags	Default
1A01:0	AI TxPDO-Map Compact Ch.1	PDO Mapping TxPDO 2	UINT8	RO	0x01 (1 _{dec})
1A01:01	SubIndex 001	1. PDO Mapping entry (object 0x6000 (AI Inputs), entry 0x11 (Value))	UINT32	RO	0x6000:11, 16

Index 1A02 AI TxPDO-Map Standard Ch.

Index (hex)	Name	Meaning	Data type	Flags	Default
1A02:0	AI TxPDO-Map Standard Ch.2	PDO Mapping TxPDO	UINT8	RO	0x0B (11 _{dec})
1A02:01	SubIndex 001	1. PDO Mapping entry (object 0x6010 (AI Inputs), entry 0x01 (Underrange))	UINT32	RO	0x6010:01, 1
1A02:02	SubIndex 002	2. PDO Mapping entry (object 0x6010 (AI Inputs), entry 0x02 (Overrange))	UINT32	RO	0x6010:02, 1
1A02:03	SubIndex 003	3. PDO Mapping entry (object 0x6010 (AI Inputs), entry 0x03 (Limit 1))	UINT32	RO	0x6010:03, 2
1A02:04	SubIndex 004	4. PDO Mapping entry (object 0x6010 (AI Inputs), entry 0x05 (Limit 2))	UINT32	RO	0x6010:05, 2
1A02:05	SubIndex 005	5. PDO Mapping entry (object 0x6010 (AI Inputs), entry 0x07 (Error))	UINT32	RO	0x6010:07, 1
1A02:06	SubIndex 006	6. PDO Mapping entry (1 bit align)	UINT32	RO	0x0000:00, 1
1A02:07	SubIndex 007	7. PDO Mapping entry (5 bits align)	UINT32	RO	0x0000:00, 5
1A02:08	SubIndex 008	8. PDO Mapping entry (object 0x6010 (AI Inputs), entry 0x0E (Sync Error))	UINT32	RO	0x6010:0E, 1
1A02:09	SubIndex 009	9. PDO Mapping entry (object 0x6010 (AI Inputs), entry 0x0F (TxPDO State))	UINT32	RO	0x6010:0F, 1
1A02:0A	SubIndex 010	10. PDO Mapping entry (object 0x6010 (AI Inputs), entry 0x10 (TxPDO Toggle))	UINT32	RO	0x6010:10, 1
1A02:0B	SubIndex 011	11. PDO Mapping entry (object 0x6010 (AI Inputs), entry 0x11 (Value))	UINT32	RO	0x6010:11, 16

Index 1A03 AI TxPDO-Map Compact Ch.2

Index (hex)	Name	Meaning	Data type	Flags	Default
1A03:0	AI TxPDO-Map Compact Ch.2	PDO Mapping TxPDO 4	UINT8	RO	0x01 (1 _{dec})
1A03:01	SubIndex 001	1. PDO Mapping entry (object 0x6010 (AI Inputs), entry 0x11 (Value))	UINT32	RO	0x6010:11, 16

Index 1A04 AI TxPDO-Map Standard Ch.3

Index (hex)	Name	Meaning	Data type	Flags	Default
1A04:0	AI TxPDO-Map Standard Ch.3	PDO Mapping TxPDO	UINT8	RO	0x0B (11 _{dec})
1A04:01	SubIndex 001	1. PDO Mapping entry (object 0x6020 (AI Inputs), entry 0x01 (Underrange))	UINT32	RO	0x6020:01, 1
1A04:02	SubIndex 002	2. PDO Mapping entry (object 0x6020 (AI Inputs), entry 0x02 (Overrange))	UINT32	RO	0x6020:02, 1
1A04:03	SubIndex 003	3. PDO Mapping entry (object 0x6020 (AI Inputs), entry 0x03 (Limit 1))	UINT32	RO	0x6020:03, 2
1A04:04	SubIndex 004	4. PDO Mapping entry (object 0x6020 (AI Inputs), entry 0x05 (Limit 2))	UINT32	RO	0x6020:05, 2
1A04:05	SubIndex 005	5. PDO Mapping entry (object 0x6020 (AI Inputs), entry 0x07 (Error))	UINT32	RO	0x6020:07, 1
1A04:06	SubIndex 006	6. PDO Mapping entry (1 bit align)	UINT32	RO	0x0000:00, 1
1A04:07	SubIndex 007	7. PDO Mapping entry (5 bits align)	UINT32	RO	0x0000:00, 5
1A04:08	SubIndex 008	8. PDO Mapping entry (object 0x6020 (AI Inputs), entry 0x0E (Sync Error))	UINT32	RO	0x6020:0E, 1
1A04:09	SubIndex 009	9. PDO Mapping entry (object 0x6020 (AI Inputs), entry 0x0F (TxPDO State))	UINT32	RO	0x6020:0F, 1
1A04:0A	SubIndex 010	10. PDO Mapping entry (object 0x6020 (AI Inputs), entry 0x10 (TxPDO Toggle))	UINT32	RO	0x6020:10, 1
1A04:0B	SubIndex 011	11. PDO Mapping entry (object 0x6020 (AI Inputs), entry 0x11 (Value))	UINT32	RO	0x6020:11, 16

Index 1A05 AI TxPDO-Map Compact Ch.3

Index (hex)	Name	Meaning	Data type	Flags	Default
1A05:0	AI TxPDO-Map Compact Ch.3	PDO Mapping TxPDO 6	UINT8	RO	0x01 (1 _{dec})
1A05:01	SubIndex 001	1. PDO Mapping entry (object 0x6020 (AI Inputs), entry 0x11 (Value))	UINT32	RO	0x6020:11, 16

Index 1A06 AI TxPDO-Map Standard Ch.4

Index (hex)	Name	Meaning	Data type	Flags	Default
1A06:0	AI TxPDO-Map Standard Ch.4	PDO Mapping TxPDO	UINT8	RO	0x0B (11 _{dec})
1A06:01	SubIndex 001	1. PDO Mapping entry (object 0x6030 (AI Inputs), entry 0x01 (Underrange))	UINT32	RO	0x6030:01, 1
1A06:02	SubIndex 002	2. PDO Mapping entry (object 0x6030 (AI Inputs), entry 0x02 (Overrange))	UINT32	RO	0x6030:02, 1
1A06:03	SubIndex 003	3. PDO Mapping entry (object 0x6030 (AI Inputs), entry 0x03 (Limit 1))	UINT32	RO	0x6030:03, 2
1A06:04	SubIndex 004	4. PDO Mapping entry (object 0x6030 (AI Inputs), entry 0x05 (Limit 2))	UINT32	RO	0x6030:05, 2
1A06:05	SubIndex 005	5. PDO Mapping entry (object 0x6030 (AI Inputs), entry 0x07 (Error))	UINT32	RO	0x6030:07, 1
1A06:06	SubIndex 006	6. PDO Mapping entry (1 bit align)	UINT32	RO	0x0000:00, 1
1A06:07	SubIndex 007	7. PDO Mapping entry (5 bits align)	UINT32	RO	0x0000:00, 5
1A06:08	SubIndex 008	8. PDO Mapping entry (object 0x6030 (AI Inputs), entry 0x0E (Sync Error))	UINT32	RO	0x6030:0E, 1
1A06:09	SubIndex 009	9. PDO Mapping entry (object 0x6030 (AI Inputs), entry 0x0F (TxPDO State))	UINT32	RO	0x6030:0F, 1
1A06:0A	SubIndex 010	10. PDO Mapping entry (object 0x6030 (AI Inputs), entry 0x10 (TxPDO Toggle))	UINT32	RO	0x6030:10, 1
1A06:0B	SubIndex 011	11. PDO Mapping entry (object 0x6030 (AI Inputs), entry 0x11 (Value))	UINT32	RO	0x6030:11, 16

Index 1A07 AI TxPDO-Map Compact Ch.4

Index (hex)	Name	Meaning	Data type	Flags	Default
1A07:0	AI TxPDO-Map Compact Ch.4	PDO Mapping TxPDO 8	UINT8	RO	0x01 (1 _{dec})
1A07:01	SubIndex 001	1. PDO Mapping entry (object 0x6030 (AI Inputs), entry 0x11 (Value))	UINT32	RO	0x6030:11, 16

Index 1C00 Sync manager type

Index (hex)	Name	Meaning	Data type	Flags	Default
1C00:0	Sync manager type	Using the sync managers	UINT8	RO	0x04 (4 _{dec})
1C00:01	SubIndex 001	Sync-Manager Type Channel 1: Mailbox Write	UINT8	RO	0x01 (1 _{dec})
1C00:02	SubIndex 002	Sync-Manager Type Channel 2: Mailbox Read	UINT8	RO	0x02 (2 _{dec})
1C00:03	SubIndex 003	Sync-Manager Type Channel 3: Process Data Write (Outputs)	UINT8	RO	0x03 (3 _{dec})
1C00:04	SubIndex 004	Sync-Manager Type Channel 4: Process Data Read (Inputs)	UINT8	RO	0x04 (4 _{dec})

Index 1C12 RxPDO assign

Index (hex)	Name	Meaning	Data type	Flags	Default
1C12:0	RxPDO assign	PDO Assign Outputs	UINT8	RW	0x00 (0 _{dec})

Index 1C13 TxPDO assign

For operation on masters other than TwinCAT it must be ensured that the channels are entered in the PDO assignment ("TxPDO assign", object 0x1C13) successively.

Index (hex)	Name	Meaning	Data type	Flags	Default
1C13:0	TxPDO assign	PDO Assign Inputs	UINT8	RW	0x04 (4 _{dec})
1C13:01	SubIndex 001	1. zugeordnete TxPDO (enthält den Index des zugehörigen TxPDO Mapping Objekts)	UINT16	RW	0x1A00 (6656 _{dec})
1C13:02	SubIndex 002	2. zugeordnete TxPDO (enthält den Index des zugehörigen TxPDO Mapping Objekts)	UINT16	RW	0x1A02 (6658 _{dec})
1C13:03	SubIndex 003	3. zugeordnete TxPDO (enthält den Index des zugehörigen TxPDO Mapping Objekts)	UINT16	RW	0x1A04 (6660 _{dec})
1C13:04	SubIndex 004	4. zugeordnete TxPDO (enthält den Index des zugehörigen TxPDO Mapping Objekts)	UINT16	RW	0x1A06 (6662 _{dec})

Index 1C33 SM input parameter

Index (hex)	Name	Meaning	Data type	Flags	Default
1C33:0	SM input parameter	Synchronization parameters for the inputs	UINT8	RO	0x20 (32 _{dec})
1C33:01	Sync mode	Current synchronization mode: <ul style="list-style-type: none"> • Bit 0 = 0: Free Run • Bit 0 = 1: Synchron with SM 2 Event • Bit 15 = 0: Standard • Bit 15 = 1: FastOp mode (CoE deactivated) 	UINT16	RW	0x0000 (0 _{dec})
1C33:02	Cycle time	Cycle time (in ns): <ul style="list-style-type: none"> • Free Run: Cycle time of the local timer • Synchronous with SM 2 event: Master cycle time • DC-Mode: SYNC0/SYNC1 Cycle Time 	UINT32	RW	0x000F4240 (1000000 _{dec})
1C33:03	Shift time	Time between SYNC0 event and reading of the inputs (in ns, only DC mode)	UINT32	RO	0x00000000 (0 _{dec})
1C33:04	Sync modes supported	Supported synchronization modes: <ul style="list-style-type: none"> • Bit 0: free run is supported • Bit 1: synchronous with SM 2 event is supported (outputs available) • Bit 1: synchronous with SM 3 event is supported (no outputs available) • Bit 2-3 = 01: DC mode is supported • Bit 4-5 = 01: input shift through local event (outputs available) • Bit 4-5 = 10: input shift with SYNC1 event (no outputs available) • Bit 14 = 1: dynamic times (measurement through writing of 0x1C33:08) 	UINT16	RO	0xC003 (49155 _{dec})
1C33:05	Minimum cycle time	Minimum cycle time (in ns)	UINT32	RO	0x0000FDE8 (65000 _{dec})
1C33:06	Calc and copy time	Time between reading of the inputs and availability of the inputs for the master (in ns, only DC mode)	UINT32	RO	0x00000000 (0 _{dec})
1C33:07	Minimum delay time		UINT32	RO	0x00000000 (0 _{dec})
1C33:08	Get cycle time	With this entry the real required process data provision time can be measured. <ul style="list-style-type: none"> • 0: Measurement of the local cycle time is stopped • 1: Measurement of the local cycle time is started The entries 0x1C33:03, 0x1C33:06, 1C33:09 are updated with the maximum measured values. For a subsequent measurement the measured values are reset.	UINT16	RW	0x0000 (0 _{dec})
1C33:09	Maximum delay time	Time between SYNC1 event and reading of the inputs (in ns, only DC mode)	UINT32	RO	0x00000000 (0 _{dec})
1C33:0B	SM event missed counter	Number of missed SM events in OPERATIONAL (DC mode only)	UINT16	RO	0x0000 (0 _{dec})
1C33:0C	Cycle exceeded counter	Number of occasions the cycle time was exceeded in OPERATIONAL (cycle was not completed in time or the next cycle began too early)	UINT16	RO	0x0000 (0 _{dec})
1C33:0D	Shift too short counter	Number of occasions that the interval between SYNC0 and SYNC1 event was too short (DC mode only)	UINT16	RO	0x0000 (0 _{dec})
1C33:20	Sync error	The synchronization was not correct in the last cycle (outputs were output too late; DC mode only)	BOOLEAN	RO	0x00 (0 _{dec})

Index F009* Password protection**

Index (hex)	Name	Meaning	Data type	Flags	Default
F009:0	Password protection	Password protection user calibration [► 259]	UINT32	RW	0x00000000 (0 _{dec})

***) for EL31xx, see [note \[► 259\]](#)

5.6.3.4 EL3124-0090

5.6.3.4.1 Restore object

Index 1011 Restore default parameters

Index (hex)	Name	Meaning	Data type	Flags	Default
1011:0	Restore default parameters [▶ 503]	Restore default parameters	UINT8	RO	0x01 (1 _{dec})
1011:01	SubIndex 001	If this object is set to “0x64616F6C” in the set value dialog, all backup objects are reset to their delivery state.	UINT32	RW	0x00000000 (0 _{dec})

5.6.3.4.2 Configuration data

Index 80n0*** AI settings (for 0 ≤ n ≤ 3)

Index (hex)	Name	Meaning	Data type	Flags	Default
80n0:0	AI Settings	Maximum subindex	UINT8	RO	0x18 (24 _{dec})
80n0:01	Enable user scale [▶ 269]	User scale is active.	BOOLEAN	RW	0x00 (0 _{dec})
80n0:02	Presentation [▶ 244]	0: Signed presentation 1: Unsigned presentation 2: Absolute value with MSB as sign Signed amount representation	BIT3	RW	0x00 (0 _{dec})
80n0:05	Siemens bits [▶ 246]	The S5 bits are displayed in the three low-order bits	BOOLEAN	RW	0x00 (0 _{dec})
80n0:06	Enable filter	Enable filter, which makes PLC-cycle-synchronous data exchange unnecessary	BOOLEAN	RW	0x00 (0 _{dec})
80n0:07	Enable limit 1 [▶ 246]	Limit 1 enabled	BOOLEAN	RW	0x00 (0 _{dec})
80n0:08	Enable limit 2 [▶ 246]	Limit 2 enabled	BOOLEAN	RW	0x00 (0 _{dec})
80n0:0A	Enable user calibration [▶ 269]	Enabling of the user calibration	BOOLEAN	RW	0x00 (0 _{dec})
80n0:0B	Enable vendor calibration [▶ 269]	Enabling of the vendor calibration	BOOLEAN	RW	0x01 (1 _{dec})
80n0:0E	Swap limit bits [▶ 247]	Changing of the Limit Bits	BOOLEAN	RW	0x00 (0 _{dec})
80n0:11	User scale offset [▶ 269]	User scaling offset	INT16	RW	0x0000 (0 _{dec})
80n0:12	User scale gain [▶ 269]	User scaling gain. The gain is represented in fixed-point format, with the factor 2 ⁻¹⁶ . The value 1 corresponds to 65536 _{dec} (0x00010000) and is limited to ±0x7FFFF	INT32	RW	0x00010000 (65536 _{dec})
80n0:13	Limit 1 [▶ 246]	First limit value for setting the status bits	INT16	RW	0x0000 (0 _{dec})
80n0:14	Limit 2 [▶ 246]	Second limit value for setting the status bits	INT16	RW	0x0000 (0 _{dec})
80n0:15	Filter settings	This object determines the digital filter settings, if it is active via Enable filter (index 0x80n0:06 [▶ 362]). The possible settings are sequentially numbered. 0: 50 Hz FIR 1: 60 Hz FIR 2: IIR 1 3: IIR 2 4: IIR 3 5: IIR 4 6: IIR 5 7: IIR 6 8: IIR 7 9: IIR 8	UINT16	RW	0x0000 (0 _{dec})
80n0:17	User calibration offset [▶ 269]	User offset compensation	INT16	RW	0x0000 (0 _{dec})
80n0:18	User calibration gain [▶ 269]	User calibration gain	INT16	RW	0x4000 (16384 _{dec})

***) since revision no. EL31xx-00xx-0016

Filter

The filters of the EL30xx/EL31xx are activated or deactivated via the CoE index 0x8000:15.



The filter characteristics are set via index 0x8000:15

The filter frequencies are set for all channels of the EL30xx/EL31xx terminals centrally via index 0x8000:15 (channel 1). All other corresponding indices 0x80n0:15 have no parameterization function! The latest firmware version (see [status table \[▶ 484\]](#)) returns an EtherCAT-compliant error message, if the filter characteristics of other channels (index 0x80n0:06, 0x80n0:15) are set.

Index 8040 TSC Settings

Index (hex)	Name	Meaning	Data type	Flags	Default value
8040:0	TSC Settings [▶ 272]	Max. ubindex	UINT8	RO	0x02 (2 _{dec})
8040:01	Address	TwinSAFE SC Address	UINT16	RW	0x0000 (0 _{dec})
8040:02	Connection Mode	Selection of TwinSAFE SC CRC	UINT32	RO	0x00000000 (0 _{dec})

5.6.3.4.3 Profile-specific objects (0x6000-0xFFFF)

The profile-specific objects have the same meaning for all EtherCAT slaves that support the profile 5001.

5.6.3.4.3.1 Input data

Index 60n0* AI inputs (for 0 ≤ n ≤ 3)**

Index (hex)	Name	Meaning	Data type	Flags	Default
60n0:0	AI inputs	Maximum subindex	INT16	RO	0x11 (17 _{dec})
60n0:01	Underrange	Value below measuring range.	BOOLEAN	RO	0x00 (0 _{dec})
60n0:02	Overrange	Measuring range exceeded.	BOOLEAN	RO	0x00 (0 _{dec})
60n0:03	Limit 1	Limit value monitoring Limit 1 0: not active 1: value is smaller than limit value 1 2: value is larger than limit value 1 3: Value is equal to limit value 1	BIT2	RO	0x00 (0 _{dec})
60n0:05	Limit 2	Limit value monitoring limit 2 0: not active 1: value is smaller than limit value 2 2: value is larger than limit value 2 3: Value is equal to limit value 2	BIT2	RO	0x00 (0 _{dec})
60n0:07	Error	The error bit is set if the data is invalid (over-range, under-range)	BOOLEAN	RO	0x00 (0 _{dec})
60n0:0E	Sync error	The Sync error bit is only required for DC mode. It indicates whether a synchronization error has occurred during the previous cycle. This means a SYNC signal was triggered in the EL31xx, although no new process data were available (0=OK, 1=NOK).	BOOLEAN	RO	0x00 (0 _{dec})
60n0:0F	TxPDO State	Validity of the data of the associated TxPDO (0 = valid, 1 = invalid).	BOOLEAN	RO	0x00 (0 _{dec})
60n0:10	TxPDO Toggle	The TxPDO toggle is toggled by the slave when the data of the associated TxPDO is updated.	BOOLEAN	RO	0x00 (0 _{dec})
60n0:11	Value	Analog input date	INT16	RO	0x0000 (0 _{dec})

***) since revision no. EL31xx-00xx-0016

Index 6040 TSC Slave Frame Elements

Index (hex)	Name	Meaning	Data type	Flags	Default value
6040:0	TSC Slave Frame Elements [▶ 272]	Max. subindex	UINT8	RO	0x06 (7 _{dec})
6040:01	TSC__Slave Cmd	reserved	UINT8	RO	0x00 (0 _{dec})
6040:02	TSC__Slave ConnID	reserved	UINT16	RO	0x0000 (0 _{dec})
6040:03	TSC__Slave CRC_0	reserved	UINT16	RO	0x0000 (0 _{dec})
6040:04	TSC__Slave CRC_1	reserved	UINT16	RO	0x0000 (0 _{dec})
6040:05	TSC__Slave CRC_2	reserved	UINT16	RO	0x0000 (0 _{dec})
6040:06	TSC__Slave CRC_3	reserved	UINT16	RO	0x0000 (0 _{dec})

5.6.3.4.3.2 Output data

Index 7040 TSC Master Frame Elements

Index (hex)	Name	Meaning	Data type	Flags	Default value
7040:0	TSC Master Frame Elements	Max. subindex	UINT8	RO	0x03 (3 _{dec})
7040:01	TSC__Master Cmd	reserved	UINT8	RO	0x00 (0 _{dec})
7040:02	TSC__Master ConnID	reserved	UINT16	RO	0x0000 (0 _{dec})
7040:03	TSC__Master CRC_0	reserved	UINT16	RO	0x0000 (0 _{dec})

5.6.3.4.3.3 Configuration data (vendor-specific)

Index 80nF*** AI vendor data (for $0 \leq n \leq 3$)

Index (hex)	Name	Meaning	Data type	Flags	Default
80nF:0	AI vendor data	Maximum subindex	UINT8	RO	0x02 (2 _{dec})
80nF:01	Calibration offset	Offset (vendor calibration)	INT16	RW	0x0000 (0 _{dec})
80nF:02	Calibration gain	Gain (vendor calibration)	INT16	RW	0x4000 (16384 _{dec})

***) since revision no. EL31xx-00xx-0016

5.6.3.4.3.4 Information and diagnostic data

Index 80nE*** AI internal data (for $0 \leq n \leq 3$)

Index (hex)	Name	Meaning	Data type	Flags	Default
80nE:0	AI internal data	Maximum subindex	UINT8	RO	0x01 (1 _{dec})
80nE:01	ADC raw value	ADC raw value	UINT16	RO	-

***) since revision no. EL31xx-00xx-0016

Index F000*** Modular device profile

Index (hex)	Name	Meaning	Data type	Flags	Default
F000:0	Modular device profile	General information for the modular device profile	UINT8	RO	0x02 (2 _{dec})
F000:01	Module index distance	Index spacing of the objects of the individual channels	UINT16	RO	0x0010 (16 _{dec})
F000:02	Maximum number of modules	Number of channels	UINT16	RO	Max. Channels number of the terminal

***) since revision no. EL31xx-00xx-0016

Index F008* Code word**

Index	Name	Meaning	Data type	Flags	Default
F008:0	Code word	reserved	UINT32	RW	0x00000000 (0 _{dec})

***) since revision no. EL31xx-00xx-0016

Index F010* module list (for 1 ≤ n ≤ 4, depends on number of channels)**

Index (hex)	Name	Meaning	Data type	Flags	Default
F010:0	Module list	Maximum subindex	UINT8	RW	0x0n
F010:0n	SubIndex 00n	Analog input profile (300)	UINT32	RW	0x0000012C (300 _{dec})

***) since revision no. EL31xx-00xx-0016

5.6.3.4.4 Standard objects

Standard objects (0x1000-0x1FFF)

The standard objects have the same meaning for all EtherCAT slaves.

Index 1000 Device type

Index (hex)	Name	Meaning	Data type	Flags	Default
1000:0	Device type	Device type of the EtherCAT slave: the Lo-Word contains the CoE profile used (5001). The Hi-Word contains the module profile according to the modular device profile.	UINT32	RO	0x012C1389 (19665801 _{dec})

Index 1008 Device name

Index (hex)	Name	Meaning	Data type	Flags	Default
1008:0	Device name	Device name of the EtherCAT slave	STRING	RO	EL31xx

Index 1009 Hardware version

Index (hex)	Name	Meaning	Data type	Flags	Default
1009:0	Hardware version	Hardware version of the EtherCAT slave	STRING	RO	00

Index 100A Software version

Index (hex)	Name	Meaning	Data type	Flags	Default
100A:0	Software version	Firmware version of the EtherCAT slave	STRING	RO	-

Index 1018 Identity

Index (hex)	Name	Meaning	Data type	Flags	Default
1018:0	Identity	Information for identifying the slave	UINT8	RO	0x04 (4 _{dec})
1018:01	Vendor ID	Vendor ID of the EtherCAT slave	UINT32	RO	0x00000002 (2 _{dec})
1018:02	Product code	Product code of the EtherCAT slave	UINT32	RO	0xFFFF3052
1018:03	Revision	Revision number of the EtherCAT slave; the low word (bit 0-15) indicates the special terminal number, the high word (bit 16-31) refers to the device description	UINT32	RO	-
1018:04	Serial number	Serial number of the EtherCAT slave; the low byte (bit 0-7) of the low word contains the year of production, the high byte (bit 8-15) of the low word contains the week of production, the high word (bit 16-31) is 0	UINT32	RO	-

Index 10F0* Backup parameter handling**

Index (hex)	Name	Meaning	Data type	Flags	Default
10F0:0	Backup parameter handling	Information for standardized loading and saving of backup entries	UINT8	RO	0x01 (1 _{dec})
10F0:01	Checksum	Checksum across all backup entries of the EtherCAT slave	UINT32	RO	-

***) since revision no. EL31xx-00xx-0016

Index 1600 TSC RxPDO-Map Master Message

Index (hex)	Name	Meaning	Data type	Flags	Default value
1600:0	TSC RxPDO-Map Master Message	PDO Mapping RxPDO	UINT8	RO	0x04 (4 _{dec})
1600:01	SubIndex 001	1. PDO Mapping entry (object 0x7040 (TSC Master Frame Elements), entry 0x01 (TSC__Master Cmd))	UINT32	RO	0x7040:01, 8
1600:02	SubIndex 002	2. PDO Mapping entry (8 bits align)	UINT32	RO	0x0000:00, 8
1600:03	SubIndex 003	3. PDO Mapping entry (object 0x7040 (TSC Master Frame Elements), entry 0x03 (TSC__Master CRC_0))	UINT32	RO	0x7040:03, 16
1600:04	SubIndex 004	4. PDO Mapping entry (object 0x7040 (TSC Master Frame Elements), entry 0x02 (TSC__Master ConnID))	UINT32	RO	0x7040:02, 16

Index 1800 AI TxPDO-Par Standard Ch.1

Index (hex)	Name	Meaning	Data type	Flags	Default
1800:0	AI TxPDO-Par Standard Ch.1	PDO parameter TxPDO 1	UINT8	RO	0x06 (6 _{dec})
1800:06	Exclude TxPDOs	Specifies the TxPDOs (index of TxPDO mapping objects) that must not be transferred together with TxPDO 1	OCTET-STRING[2]	RO	01 1A

Index 1801 AI TxPDO-Par Compact Ch.1

Index (hex)	Name	Meaning	Data type	Flags	Default
1801:0	AI TxPDO-Par Compact Ch.1	PDO parameter TxPDO 2	UINT8	RO	0x06 (6 _{dec})
1801:06	Exclude TxPDOs	Specifies the TxPDOs (index of TxPDO mapping objects) that must not be transferred together with TxPDO 2	OCTET-STRING[2]	RO	00 1A

Index 1802 AI TxPDO-Par Standard Ch.2

Index (hex)	Name	Meaning	Data type	Flags	Default
1802:0	AI TxPDO-Par Standard Ch.2	PDO parameter TxPDO 3	UINT8	RO	0x06 (6 _{dec})
1802:06	Exclude TxPDOs	Specifies the TxPDOs (index of TxPDO mapping objects) that must not be transferred together with TxPDO 3	OCTET-STRING[2]	RO	03 1A

Index 1803 AI TxPDO-Par Compact Ch. 2

Index (hex)	Name	Meaning	Data type	Flags	Default
1803:0	AI TxPDO-Par Compact Ch.2	PDO parameter TxPDO 4	UINT8	RO	0x06 (6 _{dec})
1803:06	Exclude TxPDOs	Specifies the TxPDOs (index of TxPDO mapping objects) that must not be transferred together with TxPDO 4	OCTET-STRING[2]	RO	02 1A

Index 1804 AI TxPDO-Par Standard Ch.3

Index (hex)	Name	Meaning	Data type	Flags	Default
1804:0	AI TxPDO-Par Standard Ch.3	PDO parameter TxPDO 5	UINT8	RO	0x06 (6 _{dec})
1804:06	Exclude TxPDOs	Specifies the TxPDOs (index of TxPDO mapping objects) that must not be transferred together with TxPDO 5	OCTET-STRING[2]	RO	05 1A

Index 1805 AI TxPDO-Par Compact Ch. 3

Index (hex)	Name	Meaning	Data type	Flags	Default
1805:0	AI TxPDO-Par Compact Ch.3	PDO parameter TxPDO 6	UINT8	RO	0x06 (6 _{dec})
1805:06	Exclude TxPDOs	Specifies the TxPDOs (index of TxPDO mapping objects) that must not be transferred together with TxPDO 6	OCTET-STRING[2]	RO	04 1A

Index 1806 AI TxPDO-Par Standard Ch.4

Index (hex)	Name	Meaning	Data type	Flags	Default
1806:0	AI TxPDO-Par Standard Ch.4	PDO parameter TxPDO 7	UINT8	RO	0x06 (6 _{dec})
1806:06	Exclude TxPDOs	Specifies the TxPDOs (index of TxPDO mapping objects) that must not be transferred together with TxPDO 7	OCTET-STRING[2]	RO	07 1A

Index 1807 AI TxPDO-Par Compact Ch. 4

Index (hex)	Name	Meaning	Data type	Flags	Default
1807:0	AI TxPDO-Par Compact Ch.4	PDO parameter TxPDO 8	UINT8	RO	0x06 (6 _{dec})
1807:06	Exclude TxPDOs	Specifies the TxPDOs (index of TxPDO mapping objects) that must not be transferred together with TxPDO 8	OCTET-STRING[2]	RO	06 1A

Index 1A00 AI TxPDO-Map Standard Ch.1

Index (hex)	Name	Meaning	Data type	Flags	Default
1A00:0	AI TxPDO-Map Standard Ch.1	PDO Mapping TxPDO	UINT8	RO	0x0B (11 _{dec})
1A00:01	SubIndex 001	1. PDO Mapping entry (object 0x6000 (AI Inputs), entry 0x01 (Underrange))	UINT32	RO	0x6000:01, 1
1A00:02	SubIndex 002	2. PDO Mapping entry (object 0x6000 (AI Inputs), entry 0x02 (Ovrrange))	UINT32	RO	0x6000:02, 1
1A00:03	SubIndex 003	3. PDO Mapping entry (object 0x6000 (AI Inputs), entry 0x03 (Limit 1))	UINT32	RO	0x6000:03, 2
1A00:04	SubIndex 004	4. PDO Mapping entry (object 0x6000 (AI Inputs), entry 0x05 (Limit 2))	UINT32	RO	0x6000:05, 2
1A00:05	SubIndex 005	5. PDO Mapping entry (object 0x6000 (AI Inputs), entry 0x07 (Error))	UINT32	RO	0x6000:07, 1
1A00:06	SubIndex 006	6. PDO Mapping entry (1 bit align)	UINT32	RO	0x0000:00, 1
1A00:07	SubIndex 007	7. PDO Mapping entry (5 bits align)	UINT32	RO	0x0000:00, 5
1A00:08	SubIndex 008	8. PDO Mapping entry (object 0x6000 (AI Inputs), entry 0x0E (Sync Error))	UINT32	RO	0x6000:0E, 1
1A00:09	SubIndex 009	9. PDO Mapping entry (object 0x6000 (AI Inputs), entry 0x0F (TxPDO State))	UINT32	RO	0x6000:0F, 1
1A00:0A	SubIndex 010	10. PDO Mapping entry (object 0x6000 (AI Inputs), entry 0x10 (TxPDO Toggle))	UINT32	RO	0x6000:10, 1
1A00:0B	SubIndex 011	11. PDO Mapping entry (object 0x6000 (AI Inputs), entry 0x11 (Value))	UINT32	RO	0x6000:11, 16

Index 1A01 AI TxPDO-Map Compact Ch.1

Index (hex)	Name	Meaning	Data type	Flags	Default
1A01:0	AI TxPDO-Map Compact Ch.1	PDO Mapping TxPDO 2	UINT8	RO	0x01 (1 _{dec})
1A01:01	SubIndex 001	1. PDO Mapping entry (object 0x6000 (AI Inputs), entry 0x11 (Value))	UINT32	RO	0x6000:11, 16

Index 1A02 AI TxPDO-Map Standard Ch.

Index (hex)	Name	Meaning	Data type	Flags	Default
1A02:0	AI TxPDO-Map Standard Ch.2	PDO Mapping TxPDO	UINT8	RO	0x0B (11 _{dec})
1A02:01	SubIndex 001	1. PDO Mapping entry (object 0x6010 (AI Inputs), entry 0x01 (Underrange))	UINT32	RO	0x6010:01, 1
1A02:02	SubIndex 002	2. PDO Mapping entry (object 0x6010 (AI Inputs), entry 0x02 (Overrange))	UINT32	RO	0x6010:02, 1
1A02:03	SubIndex 003	3. PDO Mapping entry (object 0x6010 (AI Inputs), entry 0x03 (Limit 1))	UINT32	RO	0x6010:03, 2
1A02:04	SubIndex 004	4. PDO Mapping entry (object 0x6010 (AI Inputs), entry 0x05 (Limit 2))	UINT32	RO	0x6010:05, 2
1A02:05	SubIndex 005	5. PDO Mapping entry (object 0x6010 (AI Inputs), entry 0x07 (Error))	UINT32	RO	0x6010:07, 1
1A02:06	SubIndex 006	6. PDO Mapping entry (1 bit align)	UINT32	RO	0x0000:00, 1
1A02:07	SubIndex 007	7. PDO Mapping entry (5 bits align)	UINT32	RO	0x0000:00, 5
1A02:08	SubIndex 008	8. PDO Mapping entry (object 0x6010 (AI Inputs), entry 0x0E (Sync Error))	UINT32	RO	0x6010:0E, 1
1A02:09	SubIndex 009	9. PDO Mapping entry (object 0x6010 (AI Inputs), entry 0x0F (TxPDO State))	UINT32	RO	0x6010:0F, 1
1A02:0A	SubIndex 010	10. PDO Mapping entry (object 0x6010 (AI Inputs), entry 0x10 (TxPDO Toggle))	UINT32	RO	0x6010:10, 1
1A02:0B	SubIndex 011	11. PDO Mapping entry (object 0x6010 (AI Inputs), entry 0x11 (Value))	UINT32	RO	0x6010:11, 16

Index 1A03 AI TxPDO-Map Compact Ch.2

Index (hex)	Name	Meaning	Data type	Flags	Default
1A03:0	AI TxPDO-Map Compact Ch.2	PDO Mapping TxPDO 4	UINT8	RO	0x01 (1 _{dec})
1A03:01	SubIndex 001	1. PDO Mapping entry (object 0x6010 (AI Inputs), entry 0x11 (Value))	UINT32	RO	0x6010:11, 16

Index 1A04 AI TxPDO-Map Standard Ch.3

Index (hex)	Name	Meaning	Data type	Flags	Default
1A04:0	AI TxPDO-Map Standard Ch.3	PDO Mapping TxPDO	UINT8	RO	0x0B (11 _{dec})
1A04:01	SubIndex 001	1. PDO Mapping entry (object 0x6020 (AI Inputs), entry 0x01 (Underrange))	UINT32	RO	0x6020:01, 1
1A04:02	SubIndex 002	2. PDO Mapping entry (object 0x6020 (AI Inputs), entry 0x02 (Overrange))	UINT32	RO	0x6020:02, 1
1A04:03	SubIndex 003	3. PDO Mapping entry (object 0x6020 (AI Inputs), entry 0x03 (Limit 1))	UINT32	RO	0x6020:03, 2
1A04:04	SubIndex 004	4. PDO Mapping entry (object 0x6020 (AI Inputs), entry 0x05 (Limit 2))	UINT32	RO	0x6020:05, 2
1A04:05	SubIndex 005	5. PDO Mapping entry (object 0x6020 (AI Inputs), entry 0x07 (Error))	UINT32	RO	0x6020:07, 1
1A04:06	SubIndex 006	6. PDO Mapping entry (1 bit align)	UINT32	RO	0x0000:00, 1
1A04:07	SubIndex 007	7. PDO Mapping entry (5 bits align)	UINT32	RO	0x0000:00, 5
1A04:08	SubIndex 008	8. PDO Mapping entry (object 0x6020 (AI Inputs), entry 0x0E (Sync Error))	UINT32	RO	0x6020:0E, 1
1A04:09	SubIndex 009	9. PDO Mapping entry (object 0x6020 (AI Inputs), entry 0x0F (TxPDO State))	UINT32	RO	0x6020:0F, 1
1A04:0A	SubIndex 010	10. PDO Mapping entry (object 0x6020 (AI Inputs), entry 0x10 (TxPDO Toggle))	UINT32	RO	0x6020:10, 1
1A04:0B	SubIndex 011	11. PDO Mapping entry (object 0x6020 (AI Inputs), entry 0x11 (Value))	UINT32	RO	0x6020:11, 16

Index 1A05 AI TxPDO-Map Compact Ch.3

Index (hex)	Name	Meaning	Data type	Flags	Default
1A05:0	AI TxPDO-Map Compact Ch.3	PDO Mapping TxPDO 6	UINT8	RO	0x01 (1 _{dec})
1A05:01	SubIndex 001	1. PDO Mapping entry (object 0x6020 (AI Inputs), entry 0x11 (Value))	UINT32	RO	0x6020:11, 16

Index 1A06 AI TxPDO-Map Standard Ch.4

Index (hex)	Name	Meaning	Data type	Flags	Default
1A06:0	AI TxPDO-Map Standard Ch.4	PDO Mapping TxPDO	UINT8	RO	0x0B (11 _{dec})
1A06:01	SubIndex 001	1. PDO Mapping entry (object 0x6030 (AI Inputs), entry 0x01 (Underrange))	UINT32	RO	0x6030:01, 1
1A06:02	SubIndex 002	2. PDO Mapping entry (object 0x6030 (AI Inputs), entry 0x02 (Overrange))	UINT32	RO	0x6030:02, 1
1A06:03	SubIndex 003	3. PDO Mapping entry (object 0x6030 (AI Inputs), entry 0x03 (Limit 1))	UINT32	RO	0x6030:03, 2
1A06:04	SubIndex 004	4. PDO Mapping entry (object 0x6030 (AI Inputs), entry 0x05 (Limit 2))	UINT32	RO	0x6030:05, 2
1A06:05	SubIndex 005	5. PDO Mapping entry (object 0x6030 (AI Inputs), entry 0x07 (Error))	UINT32	RO	0x6030:07, 1
1A06:06	SubIndex 006	6. PDO Mapping entry (1 bit align)	UINT32	RO	0x0000:00, 1
1A06:07	SubIndex 007	7. PDO Mapping entry (5 bits align)	UINT32	RO	0x0000:00, 5
1A06:08	SubIndex 008	8. PDO Mapping entry (object 0x6030 (AI Inputs), entry 0x0E (Sync Error))	UINT32	RO	0x6030:0E, 1
1A06:09	SubIndex 009	9. PDO Mapping entry (object 0x6030 (AI Inputs), entry 0x0F (TxPDO State))	UINT32	RO	0x6030:0F, 1
1A06:0A	SubIndex 010	10. PDO Mapping entry (object 0x6030 (AI Inputs), entry 0x10 (TxPDO Toggle))	UINT32	RO	0x6030:10, 1
1A06:0B	SubIndex 011	11. PDO Mapping entry (object 0x6030 (AI Inputs), entry 0x11 (Value))	UINT32	RO	0x6030:11, 16

Index 1A07 AI TxPDO-Map Compact Ch.4

Index (hex)	Name	Meaning	Data type	Flags	Default
1A07:0	AI TxPDO-Map Compact Ch.4	PDO Mapping TxPDO 8	UINT8	RO	0x01 (1 _{dec})
1A07:01	SubIndex 001	1. PDO Mapping entry (object 0x6030 (AI Inputs), entry 0x11 (Value))	UINT32	RO	0x6030:11, 16

Index 1A08 TSC TxPDO-Map Slave Message

Index (hex)	Name	Meaning	Data type	Flags	Default
1A08:0	TSC TxPDO-Map Slave Message	PDO Mapping TxPDO	UINT8	RW	0x0A (10 _{dec})
1A08:01	SubIndex 001	1. PDO Mapping entry (object 0x6040 (TSC Slave Frame Elements), entry 0x01 (TSC__Slave Cmd))	USINT8	RW	0x6040:01, 8
1A08:02	SubIndex 002	2. PDO Mapping entry (object 0x6000 (ENC Inputs), entry 0x11 (Counter value))	INT16	RW	0x6000:11, 16
1A08:03	SubIndex 003	3. PDO Mapping entry (object 0x6040 (TSC Slave Frame Elements), entry 0x03 (TSC__Slave CRC_0))	UINT16	RW	0x6040:03, 16
1A08:04	SubIndex 004	4. PDO Mapping entry (object 0x6010 (ENC Inputs), entry 0x11 (Counter value))	INT16	RW	0x6010:11, 16
1A08:05	SubIndex 005	5. PDO Mapping entry (object 0x6040 (TSC Slave Frame Elements), entry 0x04 (TSC__Slave CRC_1))	UINT16	RW	0x6040:04, 16
1A08:06	SubIndex 006	6. PDO Mapping entry (object 0x6020 (ENC Inputs), entry 0x11 (Counter value))	INT16	RW	0x6020:11, 16
1A08:07	SubIndex 007	7. PDO Mapping entry (object 0x6040 (TSC Slave Frame Elements), entry 0x05 (TSC__Slave CRC_2))	UINT16	RW	0x6040:05, 16
1A08:08	SubIndex 008	8. PDO Mapping entry (object 0x6030 (ENC Inputs), entry 0x11 (Counter value))	INT16	RW	0x6030:11, 16
1A08:09	SubIndex 009	9. PDO Mapping entry (object 0x6040 (TSC Slave Frame Elements), entry 0x06 (TSC__Slave CRC_3))	UINT16	RW	0x6040:06, 16
1A08:0A	SubIndex 010	10. PDO Mapping entry (object 0x6040 (TSC Slave Frame Elements), entry 0x02 (TSC__Slave ConnID))	UINT16	RW	0x6040:02, 16

Index 1C00 Sync manager type

Index (hex)	Name	Meaning	Data type	Flags	Default
1C00:0	Sync manager type	Using the sync managers	UINT8	RO	0x04 (4 _{dec})
1C00:01	SubIndex 001	Sync-Manager Type Channel 1: Mailbox Write	UINT8	RO	0x01 (1 _{dec})
1C00:02	SubIndex 002	Sync-Manager Type Channel 2: Mailbox Read	UINT8	RO	0x02 (2 _{dec})
1C00:03	SubIndex 003	Sync-Manager Type Channel 3: Process Data Write (Outputs)	UINT8	RO	0x03 (3 _{dec})
1C00:04	SubIndex 004	Sync-Manager Type Channel 4: Process Data Read (Inputs)	UINT8	RO	0x04 (4 _{dec})

Index 1C12 RxPDO assign

Index (hex)	Name	Meaning	Data type	Flags	Default
1C12:0	RxPDO assign	PDO Assign Outputs	UINT8	RW	0x1600 (5632 _{dec})

Index 1C13 TxPDO assign

For operation on masters other than TwinCAT it must be ensured that the channels are entered in the PDO assignment ("TxPDO assign", object 0x1C13) successively.

Index (hex)	Name	Meaning	Data type	Flags	Default
1C13:0	TxPDO assign	PDO Assign Inputs	UINT8	RW	0x04 (4 _{dec})
1C13:01	SubIndex 001	1. zugeordnete TxPDO (enthält den Index des zugehörigen TxPDO Mapping Objekts)	UINT16	RW	0x1A00 (6656 _{dec})
1C13:02	SubIndex 002	2. zugeordnete TxPDO (enthält den Index des zugehörigen TxPDO Mapping Objekts)	UINT16	RW	0x1A02 (6658 _{dec})
1C13:03	SubIndex 003	3. zugeordnete TxPDO (enthält den Index des zugehörigen TxPDO Mapping Objekts)	UINT16	RW	0x1A04 (6660 _{dec})
1C13:04	SubIndex 004	4. zugeordnete TxPDO (enthält den Index des zugehörigen TxPDO Mapping Objekts)	UINT16	RW	0x1A06 (6662 _{dec})
1C13:05	SubIndex 004	5. zugeordnete TxPDO (enthält den Index des zugehörigen TxPDO Mapping Objekts)	UINT16	RW	0x1A08 (6664 _{dec})

Index 1C32 SM output parameter

Index (hex)	Name	Meaning	Data type	Flags	Default
1C32:0	SM output parameter	Synchronization parameters for the outputs	UINT8	RO	0x07 (7 _{dec})
1C32:01	Sync mode	Current synchronization mode: <ul style="list-style-type: none"> • 0: Free Run • 1: Synchron with SM 2 Event • 2: DC-Mode - Synchron with SYNC0 Event • 3: DC-Mode - Synchron with SYNC1 Event 	UINT16	RW	0x0001 (1 _{dec})
1C32:02	Cycle time	Cycle time (in ns): <ul style="list-style-type: none"> • Free Run: Cycle time of the local timer • Synchronous with SM 2 event: Master cycle time • DC-Mode: SYNC0/SYNC1 Cycle Time 	UINT32	RW	0x00000000 (0 _{dec})
1C32:03	Shift time	Time between SYNC0 event and output of the outputs (in ns, DC mode only)	UINT32	RW	0x00000000 (0 _{dec})
1C32:04	Sync modes supported	Supported synchronization modes: <ul style="list-style-type: none"> • Bit 0 = 1: free run is supported • Bit 1 = 1: Synchronous with SM 2 event is supported • Bit 2-3 = 01: DC mode is supported • Bit 4-5 = 10: Output shift with SYNC1 event (only DC mode) • Bit 14 = 1: dynamic times (measurement through writing of 1C32:08 [▶ 371]) 	UINT16	RO	0x8007 (32775 _{dec})
1C32:05	Minimum cycle time	Minimum cycle time (in ns)	UINT32	RO	0x00000000 (0 _{dec})
1C32:06	Calc and copy time	Minimum time between SYNC0 and SYNC1 event (in ns, DC mode only)	UINT32	RO	0x00000000 (0 _{dec})
1C32:08	Command	<ul style="list-style-type: none"> • 0: Measurement of the local cycle time is stopped • 1: Measurement of the local cycle time is started <p>The entries 1C32:03 [▶ 371], 1C32:05 [▶ 371], 1C32:06 [▶ 371], 1C32:09 [▶ 371] are updated with the maximum measured values. For a subsequent measurement the measured values are reset</p>	UINT16	RW	0x0000 (0 _{dec})
1C32:09	Delay time	Time between SYNC1 event and output of the outputs (in ns, DC mode only)	UINT32	RO	0x00000000 (0 _{dec})
1C32:0B	SM event missed counter	Number of missed SM events in OPERATIONAL (DC mode only)	UINT16	RO	0x0000 (0 _{dec})
1C32:0C	Cycle exceeded counter	Number of occasions the cycle time was exceeded in OPERATIONAL (cycle was not completed in time or the next cycle began too early)	UINT16	RO	0x0000 (0 _{dec})
1C32:0D	Shift too short counter	Number of occasions that the interval between SYNC0 and SYNC1 event was too short (DC mode only)	UINT16	RO	0x0000 (0 _{dec})
1C32:20	Sync error	The synchronization was not correct in the last cycle (outputs were output too late; DC mode only)	BOOLEAN	RO	0x00 (0 _{dec})

Index 1C33 SM input parameter

Index (hex)	Name	Meaning	Data type	Flags	Default
1C33:0	SM input parameter	Synchronization parameters for the inputs	UINT8	RO	0x20 (32 _{dec})
1C33:01	Sync mode	Current synchronization mode: <ul style="list-style-type: none"> • Bit 0 = 0: Free Run • Bit 0 = 1: Synchron with SM 2 Event • Bit 15 = 0: Standard • Bit 15 = 1: FastOp mode (CoE deactivated) 	UINT16	RW	0x0000 (0 _{dec})
1C33:02	Cycle time	Cycle time (in ns): <ul style="list-style-type: none"> • Free Run: Cycle time of the local timer • Synchronous with SM 2 event: Master cycle time • DC-Mode: SYNC0/SYNC1 Cycle Time 	UINT32	RW	0x000F4240 (1000000 _{dec})
1C33:03	Shift time	Time between SYNC0 event and reading of the inputs (in ns, only DC mode)	UINT32	RO	0x00000000 (0 _{dec})
1C33:04	Sync modes supported	Supported synchronization modes: <ul style="list-style-type: none"> • Bit 0: free run is supported • Bit 1: synchronous with SM 2 event is supported (outputs available) • Bit 1: synchronous with SM 3 event is supported (no outputs available) • Bit 2-3 = 01: DC mode is supported • Bit 4-5 = 01: input shift through local event (outputs available) • Bit 4-5 = 10: input shift with SYNC1 event (no outputs available) • Bit 14 = 1: dynamic times (measurement through writing of 0x1C33:08) 	UINT16	RO	0xC003 (49155 _{dec})
1C33:05	Minimum cycle time	Minimum cycle time (in ns)	UINT32	RO	0x0000FDE8 (65000 _{dec})
1C33:06	Calc and copy time	Time between reading of the inputs and availability of the inputs for the master (in ns, only DC mode)	UINT32	RO	0x00000000 (0 _{dec})
1C33:07	Minimum delay time		UINT32	RO	0x00000000 (0 _{dec})
1C33:08	Get cycle time	With this entry the real required process data provision time can be measured. <ul style="list-style-type: none"> • 0: Measurement of the local cycle time is stopped • 1: Measurement of the local cycle time is started The entries 0x1C33:03, 0x1C33:06, 1C33:09 are updated with the maximum measured values. For a subsequent measurement the measured values are reset.	UINT16	RW	0x0000 (0 _{dec})
1C33:09	Maximum delay time	Time between SYNC1 event and reading of the inputs (in ns, only DC mode)	UINT32	RO	0x00000000 (0 _{dec})
1C33:0B	SM event missed counter	Number of missed SM events in OPERATIONAL (DC mode only)	UINT16	RO	0x0000 (0 _{dec})
1C33:0C	Cycle exceeded counter	Number of occasions the cycle time was exceeded in OPERATIONAL (cycle was not completed in time or the next cycle began too early)	UINT16	RO	0x0000 (0 _{dec})
1C33:0D	Shift too short counter	Number of occasions that the interval between SYNC0 and SYNC1 event was too short (DC mode only)	UINT16	RO	0x0000 (0 _{dec})
1C33:20	Sync error	The synchronization was not correct in the last cycle (outputs were output too late; DC mode only)	BOOLEAN	RO	0x00 (0 _{dec})

5.6.4 EL314x

5.6.4.1 EL3141

5.6.4.1.1 Restore object

Index 1011 Restore default parameters

Index (hex)	Name	Meaning	Data type	Flags	Default
1011:0	Restore default parameters [►_503]	Restore default parameters	UINT8	RO	0x01 (1 _{dec})
1011:01	SubIndex 001	If this object is set to “0x64616F6C” in the set value dialog, all backup objects are reset to their delivery state.	UINT32	RW	0x00000000 (0 _{dec})

5.6.4.1.2 Configuration data

Index 8000 AI settings

Index (hex)	Name	Meaning	Data type	Flags	Default
8000:0	AI Settings	Maximum subindex	UINT8	RO	0x18 (24 _{dec})
8000:01	Enable user scale [▶ 269]	User scale is active.	BOOLEAN	RW	0x00 (0 _{dec})
8000:02	Presentation [▶ 244]	0: Signed presentation 1: Unsigned presentation 2: Absolute value with MSB as sign Signed amount representation	BIT3	RW	0x00 (0 _{dec})
8000:05	Siemens bits [▶ 246]	The S5 bits are displayed in the three low-order bits	BOOLEAN	RW	0x00 (0 _{dec})
8000:06	Enable filter	Enable filter, which makes PLC-cycle-synchronous data exchange unnecessary	BOOLEAN	RW	0x00 (0 _{dec})
8000:07	Enable limit 1 [▶ 246]	Limit 1 enabled	BOOLEAN	RW	0x00 (0 _{dec})
8000:08	Enable limit 2 [▶ 246]	Limit 2 enabled	BOOLEAN	RW	0x00 (0 _{dec})
8000:0A	Enable user calibration [▶ 269]	Enabling of the user calibration	BOOLEAN	RW	0x00 (0 _{dec})
8000:0B	Enable vendor calibration [▶ 269]	Enabling of the vendor calibration	BOOLEAN	RW	0x01 (1 _{dec})
8000:0E	Swap limit bits [▶ 247]	Changing of the Limit Bits	BOOLEAN	RW	0x00 (0 _{dec})
80n0:11	User scale offset [▶ 269]	User scaling offset	INT16	RW	0x0000 (0 _{dec})
80n0:12	User scale gain [▶ 269]	User scaling gain. The gain is represented in fixed-point format, with the factor 2 ⁻¹⁶ . The value 1 corresponds to 65536 _{dec} (0x00010000) and is limited to ±0x7FFFF	INT32	RW	0x00010000 (65536 _{dec})
80n0:13	Limit 1 [▶ 246]	First limit value for setting the status bits	INT16	RW	0x0000 (0 _{dec})
80n0:14	Limit 2 [▶ 246]	Second limit value for setting the status bits	INT16	RW	0x0000 (0 _{dec})
80n0:15	Filter settings	This object determines the digital filter settings, if it is active via Enable filter (index 0x8000:06 [▶ 374]). The possible settings are sequentially numbered. 0: 50 Hz FIR 1: 60 Hz FIR 2: IIR 1 3: IIR 2 4: IIR 3 5: IIR 4 6: IIR 5 7: IIR 6 8: IIR 7 9: IIR 8	UINT16	RW	0x0000 (0 _{dec})
80n0:17	User calibration offset [▶ 269]	User offset compensation	INT16	RW	0x0000 (0 _{dec})
80n0:18	User calibration gain [▶ 269]	User calibration gain	INT16	RW	0x4000 (16384 _{dec})

***) since revision no. EL31xx-00xx-0016



The filter characteristics are set via index [0x8000:15](#) [\[▶ 374\]](#)

The filter frequencies are set for all channels of the EL31xx terminals centrally via index [0x8000:15](#) [\[▶ 374\]](#) (channel 1). All other corresponding indices 0x80n0:15 have no parameterization function!

5.6.4.1.3 Profile-specific objects (0x6000-0xFFFF)

The profile-specific objects have the same meaning for all EtherCAT slaves that support the profile 5001.

5.6.4.1.3.1 Input data

Index 6000 AI inputs

Index (hex)	Name	Meaning	Data type	Flags	Default
6000:0	AI inputs	Maximum subindex	INT16	RO	0x11 (17 _{dec})
6000:01	Underrange	Value below measuring range.	BOOLEAN	RO	0x00 (0 _{dec})
6000:02	Overrange	Measuring range exceeded.	BOOLEAN	RO	0x00 (0 _{dec})
6000:03	Limit 1	Limit value monitoring Limit 1 0: not active 1: value is smaller than limit value 1 2: value is larger than limit value 1 3: Value is equal to limit value 1	BIT2	RO	0x00 (0 _{dec})
6000:05	Limit 2	Limit value monitoring limit 2 0: not active 1: value is smaller than limit value 2 2: value is larger than limit value 2 3: Value is equal to limit value 2	BIT2	RO	0x00 (0 _{dec})
6000:07	Error	The error bit is set if the data is invalid (over-range, under-range)	BOOLEAN	RO	0x00 (0 _{dec})
6000:0E	Sync error	The Sync error bit is only required for DC mode. It indicates whether a synchronization error has occurred during the previous cycle. This means a SYNC signal was triggered in the EL31xx, although no new process data were available (0=OK, 1=NOK).	BOOLEAN	RO	0x00 (0 _{dec})
6000:0F	TxPDO State	Validity of the data of the associated TxPDO (0 = valid, 1 = invalid).	BOOLEAN	RO	0x00 (0 _{dec})
60n0:10	TxPDO Toggle	The TxPDO toggle is toggled by the slave when the data of the associated TxPDO is updated.	BOOLEAN	RO	0x00 (0 _{dec})
60n0:11	Value	Analog input date	INT16	RO	0x0000 (0 _{dec})

5.6.4.1.3.2 Configuration data (vendor-specific)

Index 800F AI vendor data

Index (hex)	Name	Meaning	Data type	Flags	Default
800F:0	AI vendor data	Maximum subindex	UINT8	RO	0x02 (2 _{dec})
800F:01	Calibration offset	Offset (vendor calibration)	INT16	RW	0x0000 (0 _{dec})
800F:02	Calibration gain	Gain (vendor calibration)	INT16	RW	0x4000 (16384 _{dec})

5.6.4.1.3.3 Information and diagnostic data

Index 800E AI internal data

Index (hex)	Name	Meaning	Data type	Flags	Default
800E:0	AI internal data	Maximum subindex	UINT8	RO	0x01 (1 _{dec})
800E:01	ADC raw value	ADC raw value	UINT16	RO	-

Index F000*** Modular device profile

Index (hex)	Name	Meaning	Data type	Flags	Default
F000:0	Modular device profile	General information for the modular device profile	UINT8	RO	0x02 (2 _{dec})
F000:01	Module index distance	Index spacing of the objects of the individual channels	UINT16	RO	0x0010 (16 _{dec})
F000:02	Maximum number of modules	Number of channels	UINT16	RO	<i>Max. Channels number of the terminal</i>

***) since revision no. EL31xx-00xx-0016

Index F008* Code word**

Index	Name	Meaning	Data type	Flags	Default
F008:0	Code word	reserved	UINT32	RW	0x00000000 (0 _{dec})

***) since revision no. EL31xx-00xx-0016

Index F009* Password protection**

Index (hex)	Name	Meaning	Data type	Flags	Default
F009:0	Password protection	Password protection user calibration [▶ 259]	UINT32	RW	0x00000000 (0 _{dec})

***) for EL31xx, see [note \[▶ 259\]](#)

Index F010* module list (for $1 \leq n \leq 4$, depends on number of channels)**

Index (hex)	Name	Meaning	Data type	Flags	Default
F010:0	Module list	Maximum subindex	UINT8	RW	0x0n
F010:0n	SubIndex 00n	Analog input profile (300)	UINT32	RW	0x0000012C (300 _{dec})

***) since revision no. EL31xx-00xx-0016

5.6.4.1.4 Standard objects**Standard objects (0x1000-0x1FFF)**

The standard objects have the same meaning for all EtherCAT slaves.

Index 1000 Device type

Index (hex)	Name	Meaning	Data type	Flags	Default
1000:0	Device type	Device type of the EtherCAT slave: the Lo-Word contains the CoE profile used (5001). The Hi-Word contains the module profile according to the modular device profile.	UINT32	RO	0x012C1389 (19665801 _{dec})

Index 1008 Device name

Index (hex)	Name	Meaning	Data type	Flags	Default
1008:0	Device name	Device name of the EtherCAT slave	STRING	RO	EL31xx

Index 1009 Hardware version

Index (hex)	Name	Meaning	Data type	Flags	Default
1009:0	Hardware version	Hardware version of the EtherCAT slave	STRING	RO	00

Index 100A Software version

Index (hex)	Name	Meaning	Data type	Flags	Default
100A:0	Software version	Firmware version of the EtherCAT slave	STRING	RO	-

Index 1018 Identity

Index (hex)	Name	Meaning	Data type	Flags	Default
1018:0	Identity	Information for identifying the slave	UINT8	RO	0x04 (4 _{dec})
1018:01	Vendor ID	Vendor ID of the EtherCAT slave	UINT32	RO	0x00000002 (2 _{dec})
1018:02	Product code	Product code of the EtherCAT slave	UINT32	RO	0xFFFF3052
1018:03	Revision	Revision number of the EtherCAT slave; the low word (bit 0-15) indicates the special terminal number, the high word (bit 16-31) refers to the device description	UINT32	RO	-
1018:04	Serial number	Serial number of the EtherCAT slave; the low byte (bit 0-7) of the low word contains the year of production, the high byte (bit 8-15) of the low word contains the week of production, the high word (bit 16-31) is 0	UINT32	RO	-

Index 10F0* Backup parameter handling**

Index (hex)	Name	Meaning	Data type	Flags	Default
10F0:0	Backup parameter handling	Information for standardized loading and saving of backup entries	UINT8	RO	0x01 (1 _{dec})
10F0:01	Checksum	Checksum across all backup entries of the EtherCAT slave	UINT32	RO	-

***) since revision no. EL31xx-00xx-0016

Index 1800 AI TxPDO-Par Standard Ch.1

Index (hex)	Name	Meaning	Data type	Flags	Default
1800:0	AI TxPDO-Par Standard Ch.1	PDO parameter TxPDO 1	UINT8	RO	0x06 (6 _{dec})
1800:06	Exclude TxPDOs	Specifies the TxPDOs (index of TxPDO mapping objects) that must not be transferred together with TxPDO 1	OCTET-STRING[2]	RO	01 1A

Index 1801 AI TxPDO-Par Compact Ch.1

Index (hex)	Name	Meaning	Data type	Flags	Default
1801:0	AI TxPDO-Par Compact Ch.1	PDO parameter TxPDO 2	UINT8	RO	0x06 (6 _{dec})
1801:06	Exclude TxPDOs	Specifies the TxPDOs (index of TxPDO mapping objects) that must not be transferred together with TxPDO 2	OCTET-STRING[2]	RO	00 1A

Index 1A00 AI TxPDO-Map Standard Ch.1

Index (hex)	Name	Meaning	Data type	Flags	Default
1A00:0	AI TxPDO-Map Standard Ch.1	PDO Mapping TxPDO	UINT8	RO	0x0B (11 _{dec})
1A00:01	SubIndex 001	1. PDO Mapping entry (object 0x6000 (AI Inputs), entry 0x01 (Underrange))	UINT32	RO	0x6000:01, 1
1A00:02	SubIndex 002	2. PDO Mapping entry (object 0x6000 (AI Inputs), entry 0x02 (Overrange))	UINT32	RO	0x6000:02, 1
1A00:03	SubIndex 003	3. PDO Mapping entry (object 0x6000 (AI Inputs), entry 0x03 (Limit 1))	UINT32	RO	0x6000:03, 2
1A00:04	SubIndex 004	4. PDO Mapping entry (object 0x6000 (AI Inputs), entry 0x05 (Limit 2))	UINT32	RO	0x6000:05, 2
1A00:05	SubIndex 005	5. PDO Mapping entry (object 0x6000 (AI Inputs), entry 0x07 (Error))	UINT32	RO	0x6000:07, 1
1A00:06	SubIndex 006	6. PDO Mapping entry (1 bit align)	UINT32	RO	0x0000:00, 1
1A00:07	SubIndex 007	7. PDO Mapping entry (5 bits align)	UINT32	RO	0x0000:00, 5
1A00:08	SubIndex 008	8. PDO Mapping entry (object 0x6000 (AI Inputs), entry 0x0E (Sync Error))	UINT32	RO	0x6000:0E, 1
1A00:09	SubIndex 009	9. PDO Mapping entry (object 0x6000 (AI Inputs), entry 0x0F (TxPDO State))	UINT32	RO	0x6000:0F, 1
1A00:0A	SubIndex 010	10. PDO Mapping entry (object 0x6000 (AI Inputs), entry 0x10 (TxPDO Toggle))	UINT32	RO	0x6000:10, 1
1A00:0B	SubIndex 011	11. PDO Mapping entry (object 0x6000 (AI Inputs), entry 0x11 (Value))	UINT32	RO	0x6000:11, 16

Index 1A01 AI TxPDO-Map Compact Ch.1

Index (hex)	Name	Meaning	Data type	Flags	Default
1A01:0	AI TxPDO-Map Compact Ch.1	PDO Mapping TxPDO 2	UINT8	RO	0x01 (1 _{dec})
1A01:01	SubIndex 001	1. PDO Mapping entry (object 0x6000 (AI Inputs), entry 0x11 (Value))	UINT32	RO	0x6000:11, 16

Index 1C00 Sync manager type

Index (hex)	Name	Meaning	Data type	Flags	Default
1C00:0	Sync manager type	Using the sync managers	UINT8	RO	0x04 (4 _{dec})
1C00:01	SubIndex 001	Sync-Manager Type Channel 1: Mailbox Write	UINT8	RO	0x01 (1 _{dec})
1C00:02	SubIndex 002	Sync-Manager Type Channel 2: Mailbox Read	UINT8	RO	0x02 (2 _{dec})
1C00:03	SubIndex 003	Sync-Manager Type Channel 3: Process Data Write (Outputs)	UINT8	RO	0x03 (3 _{dec})
1C00:04	SubIndex 004	Sync-Manager Type Channel 4: Process Data Read (Inputs)	UINT8	RO	0x04 (4 _{dec})

Index 1C12 RxPDO assign

Index (hex)	Name	Meaning	Data type	Flags	Default
1C12:0	RxPDO assign	PDO Assign Outputs	UINT8	RW	0x00 (0 _{dec})

Index 1C13 TxPDO assign

For operation on masters other than TwinCAT it must be ensured that the channels are entered in the PDO assignment ("TxPDO assign", object 0x1C13) successively.

Index (hex)	Name	Meaning	Data type	Flags	Default
1C13:0	TxPDO assign	PDO Assign Inputs	UINT8	RW	0x01 (1 _{dec})
1C13:01	SubIndex 001	1. zugeordnete TxPDO (enthält den Index des zugehörigen TxPDO Mapping Objekts)	UINT16	RW	0x1A00 (6656 _{dec})

Index 1C33 SM input parameter

Index (hex)	Name	Meaning	Data type	Flags	Default
1C33:0	SM input parameter	Synchronization parameters for the inputs	UINT8	RO	0x20 (32 _{dec})
1C33:01	Sync mode	Current synchronization mode: <ul style="list-style-type: none"> • Bit 0 = 0: Free Run • Bit 0 = 1: Synchron with SM 2 Event • Bit 15 = 0: Standard • Bit 15 = 1: FastOp mode (CoE deactivated) 	UINT16	RW	0x0000 (0 _{dec})
1C33:02	Cycle time	Cycle time (in ns): <ul style="list-style-type: none"> • Free Run: Cycle time of the local timer • Synchronous with SM 2 event: Master cycle time • DC-Mode: SYNC0/SYNC1 Cycle Time 	UINT32	RW	0x000F4240 (1000000 _{dec})
1C33:03	Shift time	Time between SYNC0 event and reading of the inputs (in ns, only DC mode)	UINT32	RO	0x00000000 (0 _{dec})
1C33:04	Sync modes supported	Supported synchronization modes: <ul style="list-style-type: none"> • Bit 0: free run is supported • Bit 1: synchronous with SM 2 event is supported (outputs available) • Bit 1: synchronous with SM 3 event is supported (no outputs available) • Bit 2-3 = 01: DC mode is supported • Bit 4-5 = 01: input shift through local event (outputs available) • Bit 4-5 = 10: input shift with SYNC1 event (no outputs available) • Bit 14 = 1: dynamic times (measurement through writing of 0x1C33:08) 	UINT16	RO	0xC003 (49155 _{dec})
1C33:05	Minimum cycle time	Minimum cycle time (in ns)	UINT32	RO	0x0000FDE8 (65000 _{dec})
1C33:06	Calc and copy time	Time between reading of the inputs and availability of the inputs for the master (in ns, only DC mode)	UINT32	RO	0x00000000 (0 _{dec})
1C33:07	Minimum delay time		UINT32	RO	0x00000000 (0 _{dec})
1C33:08	Get cycle time	With this entry the real required process data provision time can be measured. <ul style="list-style-type: none"> • 0: Measurement of the local cycle time is stopped • 1: Measurement of the local cycle time is started The entries 0x1C33:03, 0x1C33:06, 1C33:09 are updated with the maximum measured values. For a subsequent measurement the measured values are reset.	UINT16	RW	0x0000 (0 _{dec})
1C33:09	Maximum delay time	Time between SYNC1 event and reading of the inputs (in ns, only DC mode)	UINT32	RO	0x00000000 (0 _{dec})
1C33:0B	SM event missed counter	Number of missed SM events in OPERATIONAL (DC mode only)	UINT16	RO	0x0000 (0 _{dec})
1C33:0C	Cycle exceeded counter	Number of occasions the cycle time was exceeded in OPERATIONAL (cycle was not completed in time or the next cycle began too early)	UINT16	RO	0x0000 (0 _{dec})
1C33:0D	Shift too short counter	Number of occasions that the interval between SYNC0 and SYNC1 event was too short (DC mode only)	UINT16	RO	0x0000 (0 _{dec})
1C33:20	Sync error	The synchronization was not correct in the last cycle (outputs were output too late; DC mode only)	BOOLEAN	RO	0x00 (0 _{dec})

5.6.4.2 EL3142

5.6.4.2.1 Restore object

Index 1011 Restore default parameters

Index (hex)	Name	Meaning	Data type	Flags	Default
1011:0	Restore default parameters ▶ 503	Restore default parameters	UINT8	RO	0x01 (1 _{dec})
1011:01	SubIndex 001	If this object is set to "0x64616F6C" in the set value dialog, all backup objects are reset to their delivery state.	UINT32	RW	0x00000000 (0 _{dec})

5.6.4.2.2 Configuration data

Index 40n0* producer code word (for n = 4 [channel 1], n = 8 [channel 2])

● Producer code word

i The vendor reserves the authority for the basic calibration of the terminals. The Producer code word is therefore at present reserved.

*) up to rev. no. EL31x2-0000-0016, only for EL31x2, see [note regarding EL31x2 terminals before rev. no. EL31x2-0000-0016](#) [▶ 278](#)

Index 40n1 ADC raw value (for n = 4 [channel 1], n = 8 [channel 2])

(up to rev. no. EL31x2-0000-0016, only for EL31x2, see [note](#) [▶ 278](#))

Index (hex)	Name	Meaning	Flags	Default
40n1:0	ADC raw value	Length of this object	RO	1 _{dec}
40n1:01	ADC rawdata	This is the circuit's raw ADC value. It is converted to a measurement through a calculation with the gain and offset from the calibration.	RO	-

Index 40n1 feature bits (for n = 6 [channel 1], n = A [channel 2])

(up to rev. no. EL31x2-0000-0016, only for EL31x2, see [note](#) [▶ 278](#))

Index (hex)	Name	Meaning	Flags	Default	
40n1:0	Feature bits	Length of this object	RW	3 _{dec}	
40n1:01	Enable user scale	TRUE	User scaling (index 40n2 ▶ 381) is active.	RW	FALSE
		FALSE	The user scaling is deactivated.		
40n1:02	Enable absolute with MSB as sign	TRUE	The measured value is output in magnitude-sign format.	RW	FALSE
			EL3102		
		EL3142-0010	+10 mA = 0x7FFF -10 mA = 0xFFFF		
		FALSE	The measured value is output as signed integer in the two's complement		
EL3102	+10 V = 0x7FFF -10 V = 0x8001				
EL3142-0010	+10 mA = 0x7FFF -10 mA = 0x8001				
40n1:03	Enable filter	TRUE	The digital filter (index 40n5 ▶ 381 , filter settings) is active. The analog values are not converted synchronously with the exchange of process data, but in accordance with the filter setting.	RW	FALSE
		FALSE	The analog values are converted synchronously with the exchange of process data; a digital filter is not active.		

Index 40n2 calibration data (for n = 4 [channel 1], n = 8 [channel 2])

(up to rev. no. EL31x2-0000-0016, only for EL31x2, see [note](#) [▶ 278](#))

Index (hex)	Name	Meaning	Flags	Default
40n2:0	Calibration data	Length of this object	RW	2 _{dec}
40n2:01	Offset 16 bit signed integer	These objects are used to trim the tolerances of the components to determine the measured value. The values can only be changed if the producer code word is set (index 40n0 [▶ 380]).	Offset trim channel 1/ channel 2	0xXXXX
40n2:02	Gain 16 bit unsigned integer		Gain trim channel 1/ channel 2	0xXXXX

**Index 40n2 user scale (for n = 4 [channel 1], n = A [channel 2])
(Feature bit 40n1:01 enabled) 40n1:01 [▶ 380]**

(up to rev. no. EL31x2-0000-0016, only for EL31x2, see note [▶ 278])

Index (hex)	Name	Meaning	Flags	Default
40n2:0	User scale	Length of this object	RW	2 _{dec}
40n2:01	Offset 16 bit signed integer	These objects contain the user scaling.	Offset trim, user scaling channel 1/ channel 2	0x0000
40n2:02	Gain 32 bit signed integer	The scaling is enabled via 40n1:01 [▶ 380].	Gain trim, user scaling channel 1/ channel 2 The gain is represented in fixed-point format, with the factor 2 ⁻¹⁶ . A value of 1 for the gain factor therefore corresponds to 65536 _{dec} (0x00010000).	0x00010000

**Index 40n5 filter settings (for n = 4 [channel 1], n = A [channel 2])
(Feature bit 40n1:03 enabled) 40n1:03 [▶ 380]**

(up to rev. no. EL31x2-0000-0016, only for EL31x2, see note [▶ 278])

Enum value	Decimal value	Description	Default
50 Hz FIR	0	50 Hz FIR over 32 values; 50 Hz interferences are suppressed with 60 dB	50 Hz FIR (0 _{dec})
60 Hz FIR	1	60 Hz FIR over 32 values; 60 Hz interferences are suppressed with 40 dB	
IIR Level 1	2	Recursive filter, t _{rise_90%} ** = 0.72 ms	
IIR Level 2	3	Recursive filter, t _{rise_90%} ** = 1.62 ms	
IIR Level 3	4	Recursive filter, t _{rise_90%} ** = 3.24 ms	
IIR Level 4	5	Recursive filter, t _{rise_90%} ** = 6.48 ms	
IIR Level 5	6	Recursive filter, t _{rise_90%} ** = 12.96 ms	
IIR Level 6	7	Recursive filter, t _{rise_90%} ** = 25.92 ms	
IIR Level 7	8	Recursive filter, t _{rise_90%} ** = 51.84 ms	
IIR Level 8	9	Recursive filter, t _{rise_90%} ** = 103.68 ms	

**) step in rise time [t_{rise_90%}]

Index 80n0*** AI settings (for $0 \leq n \leq 1$)

Index (hex)	Name	Meaning	Data type	Flags	Default
80n0:0	AI Settings	Maximum subindex	UINT8	RO	0x18 (24 _{dec})
80n0:01	Enable user scale [▶ 269]	User scale is active.	BOOLEAN	RW	0x00 (0 _{dec})
80n0:02	Presentation [▶ 244]	0: Signed presentation 1: Unsigned presentation 2: Absolute value with MSB as sign Signed amount representation	BIT3	RW	0x00 (0 _{dec})
80n0:05	Siemens bits [▶ 246]	The S5 bits are displayed in the three low-order bits	BOOLEAN	RW	0x00 (0 _{dec})
80n0:06	Enable filter	Enable filter, which makes PLC-cycle-synchronous data exchange unnecessary	BOOLEAN	RW	0x00 (0 _{dec})
80n0:07	Enable limit 1 [▶ 246]	Limit 1 enabled	BOOLEAN	RW	0x00 (0 _{dec})
80n0:08	Enable limit 2 [▶ 246]	Limit 2 enabled	BOOLEAN	RW	0x00 (0 _{dec})
80n0:0A	Enable user calibration [▶ 269]	Enabling of the user calibration	BOOLEAN	RW	0x00 (0 _{dec})
80n0:0B	Enable vendor calibration [▶ 269]	Enabling of the vendor calibration	BOOLEAN	RW	0x01 (1 _{dec})
80n0:0E	Swap limit bits [▶ 247]	Changing of the Limit Bits	BOOLEAN	RW	0x00 (0 _{dec})
80n0:11	User scale offset [▶ 269]	User scaling offset	INT16	RW	0x0000 (0 _{dec})
80n0:12	User scale gain [▶ 269]	User scaling gain. The gain is represented in fixed-point format, with the factor 2^{-16} . The value 1 corresponds to 65536 _{dec} (0x00010000) and is limited to $\pm 0x7FFFF$	INT32	RW	0x00010000 (65536 _{dec})
80n0:13	Limit 1 [▶ 246]	First limit value for setting the status bits	INT16	RW	0x0000 (0 _{dec})
80n0:14	Limit 2 [▶ 246]	Second limit value for setting the status bits	INT16	RW	0x0000 (0 _{dec})
80n0:15	Filter settings	This object determines the digital filter settings, if it is active via Enable filter (index 0x80n0:06 [▶ 382]). The possible settings are sequentially numbered. 0: 50 Hz FIR 1: 60 Hz FIR 2: IIR 1 3: IIR 2 4: IIR 3 5: IIR 4 6: IIR 5 7: IIR 6 8: IIR 7 9: IIR 8	UINT16	RW	0x0000 (0 _{dec})
80n0:17	User calibration offset [▶ 269]	User offset compensation	INT16	RW	0x0000 (0 _{dec})
80n0:18	User calibration gain [▶ 269]	User calibration gain	INT16	RW	0x4000 (16384 _{dec})

***) since revision no. EL31xx-00xx-0016



The filter characteristics are set via index **0x8000:15** [▶ 382]

The filter frequencies are set for all channels of the EL31xx terminals centrally via index **0x8000:15** [▶ 382] (channel 1). All other corresponding indices 0x80n0:15 have no parameterization function!

5.6.4.2.3 Profile-specific objects (0x6000-0xFFFF)

The profile-specific objects have the same meaning for all EtherCAT slaves that support the profile 5001.

5.6.4.2.3.1 Input data

Index 3101 inputs (channel 1)

(up to rev. no. EL31x2-0000-0016, only for EL31x2, see [note \[► 278\]](#))

Index (hex)	Name	Meaning	Flags	Default
3101:0	Inputs	Length of this object	RO	2 _{dec}
3101:01	Status	Status byte [► 254] channel 1	RO	-
3101:02	Value	Input process data channel 1	RO	-

Index 3102 inputs (channel 2)

(up to rev. no. EL31x2-0000-0016, only for EL31x2, see [note \[► 278\]](#))

Index (hex)	Name	Meaning	Flags	Default
3102:0	Inputs	Length of this object	RO	2 _{dec}
3102:01	Status	Status byte [► 254] channel 2	RO	-
3102:02	Value	Input process data channel 2	RO	-

Index 60n0*** AI inputs (for 0 ≤ n ≤ 1)

Index (hex)	Name	Meaning	Data type	Flags	Default
60n0:0	AI inputs	Maximum subindex	INT16	RO	0x11 (17 _{dec})
60n0:01	Underrange	Value below measuring range.	BOOLEAN	RO	0x00 (0 _{dec})
60n0:02	Overrange	Measuring range exceeded.	BOOLEAN	RO	0x00 (0 _{dec})
60n0:03	Limit 1	Limit value monitoring Limit 1 0: not active 1: value is smaller than limit value 1 2: value is larger than limit value 1 3: Value is equal to limit value 1	BIT2	RO	0x00 (0 _{dec})
60n0:05	Limit 2	Limit value monitoring limit 2 0: not active 1: value is smaller than limit value 2 2: value is larger than limit value 2 3: Value is equal to limit value 2	BIT2	RO	0x00 (0 _{dec})
60n0:07	Error	The error bit is set if the data is invalid (over-range, under-range)	BOOLEAN	RO	0x00 (0 _{dec})
60n0:0E	Sync error	The Sync error bit is only required for DC mode. It indicates whether a synchronization error has occurred during the previous cycle. This means a SYNC signal was triggered in the EL31xx, although no new process data were available (0=OK, 1=NOK).	BOOLEAN	RO	0x00 (0 _{dec})
60n0:0F	TxPDO State	Validity of the data of the associated TxPDO (0 = valid, 1 = invalid).	BOOLEAN	RO	0x00 (0 _{dec})
60n0:10	TxPDO Toggle	The TxPDO toggle is toggled by the slave when the data of the associated TxPDO is updated.	BOOLEAN	RO	0x00 (0 _{dec})
60n0:11	Value	Analog input date	INT16	RO	0x0000 (0 _{dec})

***) since revision no. EL31xx-00xx-0016

Index 6401 inputs (channels 1 & 2)

(up to rev. no. EL31x2-0000-0016, only for EL31x2, see [note \[► 278\]](#))

Index (hex)	Name	Meaning	Flags	Default
6401:0	Inputs	Length of this object	RO	2 _{dec}
6401:01	Value channel 1	Input process data channel 1	RO	-
6401:02	Value channel 2	Input process data channel 2	RO	-

5.6.4.2.3.2 Configuration data (vendor-specific)

Index 80nF*** AI vendor data (for $0 \leq n \leq 1$)

Index (hex)	Name	Meaning	Data type	Flags	Default
80nF:0	AI vendor data	Maximum subindex	UINT8	RO	0x02 (2 _{dec})
80nF:01	Calibration offset	Offset (vendor calibration)	INT16	RW	0x0000 (0 _{dec})
80nF:02	Calibration gain	Gain (vendor calibration)	INT16	RW	0x4000 (16384 _{dec})

***) since revision no. EL31xx-00xx-0016

5.6.4.2.3.3 Information and diagnostic data

Index 80nE*** AI internal data (for $0 \leq n \leq 1$)

Index (hex)	Name	Meaning	Data type	Flags	Default
80nE:0	AI internal data	Maximum subindex	UINT8	RO	0x01 (1 _{dec})
80nE:01	ADC raw value	ADC raw value	UINT16	RO	-

***) since revision no. EL31xx-00xx-0016

Index F000*** Modular device profile

Index (hex)	Name	Meaning	Data type	Flags	Default
F000:0	Modular device profile	General information for the modular device profile	UINT8	RO	0x02 (2 _{dec})
F000:01	Module index distance	Index spacing of the objects of the individual channels	UINT16	RO	0x0010 (16 _{dec})
F000:02	Maximum number of modules	Number of channels	UINT16	RO	<i>Max. Channels number of the terminal</i>

***) since revision no. EL31xx-00xx-0016

Index F008*** Code word

Index	Name	Meaning	Data type	Flags	Default
F008:0	Code word	reserved	UINT32	RW	0x00000000 (0 _{dec})

***) since revision no. EL31xx-00xx-0016

Index F009*** Password protection

Index (hex)	Name	Meaning	Data type	Flags	Default
F009:0	Password protection	Password protection user calibration [► 259]	UINT32	RW	0x00000000 (0 _{dec})

***) for EL31xx, see [note \[► 259\]](#)

Index F010*** module list (for $1 \leq n \leq 4$, depends on number of channels)

Index (hex)	Name	Meaning	Data type	Flags	Default
F010:0	Module list	Maximum subindex	UINT8	RW	0x0n
F010:0n	SubIndex 00n	Analog input profile (300)	UINT32	RW	0x0000012C (300 _{dec})

***) since revision no. EL31xx-00xx-0016

5.6.4.2.4 Standard objects

Standard objects (0x1000-0x1FFF)

The standard objects have the same meaning for all EtherCAT slaves.

Index 1000 Device type

Index (hex)	Name	Meaning	Data type	Flags	Default
1000:0	Device type	Device type of the EtherCAT slave: the Lo-Word contains the CoE profile used (5001). The Hi-Word contains the module profile according to the modular device profile.	UINT32	RO	0x00001389 (5001 _{dec})

Index 1008 Device name

Index (hex)	Name	Meaning	Data type	Flags	Default
1008:0	Device name	Device name of the EtherCAT slave	STRING	RO	EL31xx

Index 1009 Hardware version

Index (hex)	Name	Meaning	Data type	Flags	Default
1009:0	Hardware version	Hardware version of the EtherCAT slave	STRING	RO	00

Index 100A Software version

Index (hex)	Name	Meaning	Data type	Flags	Default
100A:0	Software version	Firmware version of the EtherCAT slave	STRING	RO	-

Index 1018 Identity

Index (hex)	Name	Meaning	Data type	Flags	Default
1018:0	Identity	Information for identifying the slave	UINT8	RO	0x04 (4 _{dec})
1018:01	Vendor ID	Vendor ID of the EtherCAT slave	UINT32	RO	0x00000002 (2 _{dec})
1018:02	Product code	Product code of the EtherCAT slave	UINT32	RO	0xFFFF3052
1018:03	Revision	Revision number of the EtherCAT slave; the low word (bit 0-15) indicates the special terminal number, the high word (bit 16-31) refers to the device description	UINT32	RO	-
1018:04	Serial number	Serial number of the EtherCAT slave; the low byte (bit 0-7) of the low word contains the year of production, the high byte (bit 8-15) of the low word contains the week of production, the high word (bit 16-31) is 0	UINT32	RO	-

Index 10F0*** Backup parameter handling

Index (hex)	Name	Meaning	Data type	Flags	Default
10F0:0	Backup parameter handling	Information for standardized loading and saving of backup entries	UINT8	RO	0x01 (1 _{dec})
10F0:01	Checksum	Checksum across all backup entries of the EtherCAT slave	UINT32	RO	-

***) since revision no. EL31xx-00xx-0016

Index 1800 TxPDO-Par Ch.1

Index (hex)	Name	Meaning	Data type	Flags	Default
1800:0	TxPDO-Par Ch.1	PDO Parameter TxPDO	UINT8	RO	0x06 (6 _{dec})
1800:06	Exclude TxPDOs	Hier sind die TxPDOs (Index der TxPDO Mapping Objekte) angegeben, die nicht zusammen mit TxPDO 1 übertragen werden dürfen	OCTET-STRING[2]	RO	02 1A 03 1A 07 1A 10 1A

Index 1801 TxPDO-Par Ch.2

Index (hex)	Name	Meaning	Data type	Flags	Default
1801:0	TxPDO-Par Ch.2	PDO Parameter TxPDO	UINT8	RO	0x06 (6 _{dec})
1801:06	Exclude TxPDOs	Hier sind die TxPDOs (Index der TxPDO Mapping Objekte) angegeben, die nicht zusammen mit TxPDO 2 übertragen werden dürfen	OCTET-STRING[2]	RO	04 1A 05 1A 09 1A 10 1A

Index 1802 AI TxPDO-Par Standard Ch.2

Index (hex)	Name	Meaning	Data type	Flags	Default
1802:0	AI TxPDO-Par Standard Ch.2	PDO parameter TxPDO 3	UINT8	RO	0x06 (6 _{dec})
1802:06	Exclude TxPDOs	Specifies the TxPDOs (index of TxPDO mapping objects) that must not be transferred together with TxPDO 3	OCTET-STRING[2]	RO	03 1A

Index 1803 AI TxPDO-Par Compact Ch.1

Index (hex)	Name	Meaning	Data type	Flags	Default
1803:0	AI TxPDO-Par Compact Ch.1	PDO Parameter TxPDO	UINT8	RO	0x06 (6 _{dec})
1803:06	Exclude TxPDOs	Hier sind die TxPDOs (Index der TxPDO Mapping Objekte) angegeben, die nicht zusammen mit TxPDO 2 übertragen werden dürfen	OCTET-STRING[2]	RO	00 1A 02 1A 07 1A 10 1A

Index 1804 AI TxPDO-Par Standard Ch.2

Index (hex)	Name	Meaning	Data type	Flags	Default
1804:0	AI TxPDO-Par Standard Ch.2	PDO Parameter TxPDO	UINT8	RO	0x06 (6 _{dec})
1804:06	Exclude TxPDOs	Hier sind die TxPDOs (Index der TxPDO Mapping Objekte) angegeben, die nicht zusammen mit TxPDO 3 übertragen werden dürfen	OCTET-STRING[2]	RO	00 1A 05 1A 09 1A 10 1A

Index 1805 AI TxPDO-Par Compact Ch.2

Index (hex)	Name	Meaning	Data type	Flags	Default
1805:0	AI TxPDO-Par Compact Ch.2	PDO Parameter TxPDO	UINT8	RO	0x06 (6 _{dec})
1805:06	Exclude TxPDOs	Hier sind die TxPDOs (Index der TxPDO Mapping Objekte) angegeben, die nicht zusammen mit TxPDO 4 übertragen werden dürfen	OCTET-STRING[2]	RO	00 1A 04 1A 09 1A 10 1A

Index 1810 TxPDO-Par Channels

Index (hex)	Name	Meaning	Data type	Flags	Default
1810:0	TxPDO-Par Channels	PDO Parameter TxPDO	UINT8	RO	0x06 (6 _{dec})
1810:06	Exclude TxPDOs	Hier sind die TxPDOs (Index der TxPDO Mapping Objekte) angegeben, die nicht zusammen mit TxPDO 1 übertragen werden dürfen	OCTET-STRING[2]	RO	00 1A 01 1A 02 1A 03 1A 04 1A 05 1A 07 1A 09 1A

Index 1A00 TxPDO-Par Channel 1 (only for EL31x2)

Index (hex)	Name	Meaning	Data type	Flags	Default
1A0n:0	TxPDO Map Ch. 1	PDO Mapping TxPDO Ch. 1	UINT8	RO	0x02 (2 _{dec})
1A00:01	SubIndex 001	1. PDO Mapping entry (object 0x3101 (Inputs), entry 0x01 (Inputs))	UINT32	RO	0x3101:01, 1
1A00:02	SubIndex 002	2. PDO Mapping entry (object 0x3101 (Inputs), entry 0x02 (Inputs))	UINT32	RO	0x3101:02, 1

Index 1A01 TxPDO-Par Channel 2 (only for EL31x2)

Index (hex)	Name	Meaning	Data type	Flags	Default
1A01:0	TxPDO Map Ch. 1	PDO Mapping TxPDO Ch. 1	UINT8	RO	0x02 (2 _{dec})
1A01:01	SubIndex 001	1. PDO Mapping entry (object 0x3102 (Inputs), entry 0x01 (Inputs))	UINT32	RO	0x3102:01, 1
1A01:02	SubIndex 002	2. PDO Mapping entry (object 0x3102 (Inputs), entry 0x02 (Inputs))	UINT32	RO	0x3102:02, 1

Index 1A02 AI TxPDO-Map Standard Ch.1

Index (hex)	Name	Meaning	Data type	Flags	Default
1A02:0	AI TxPDO-Map Standard Ch.1	PDO Mapping TxPDO	UINT8	RO	0x0B (11 _{dec})
1A02:01	SubIndex 001	1. PDO Mapping entry (object 0x6000 (AI Inputs), entry 0x01 (Underrange))	UINT32	RO	0x6000:01, 1
1A02:02	SubIndex 002	2. PDO Mapping entry (object 0x6000 (AI Inputs), entry 0x02 (Overrange))	UINT32	RO	0x6000:02, 1
1A02:03	SubIndex 003	3. PDO Mapping entry (object 0x6000 (AI Inputs), entry 0x03 (Limit 1))	UINT32	RO	0x6000:03, 2
1A02:04	SubIndex 004	4. PDO Mapping entry (object 0x6000 (AI Inputs), entry 0x05 (Limit 2))	UINT32	RO	0x6000:05, 2
1A02:05	SubIndex 005	5. PDO Mapping entry (object 0x6000 (AI Inputs), entry 0x07 (Error))	UINT32	RO	0x6000:07, 1
1A02:06	SubIndex 006	6. PDO Mapping entry (1 bit align)	UINT32	RO	0x0000:00, 1
1A02:07	SubIndex 007	7. PDO Mapping entry (5 bits align)	UINT32	RO	0x0000:00, 5
1A02:08	SubIndex 008	8. PDO Mapping entry (object 0x6000 (AI Inputs), entry 0x0E (Sync Error))	UINT32	RO	0x6000:0E, 1
1A02:09	SubIndex 009	9. PDO Mapping entry (object 0x6000 (AI Inputs), entry 0x0F (TxPDO State))	UINT32	RO	0x6000:0F, 1
1A02:0A	SubIndex 010	10. PDO Mapping entry (object 0x6000 (AI Inputs), entry 0x10 (TxPDO Toggle))	UINT32	RO	0x6000:10, 1
1A02:0B	SubIndex 011	11. PDO Mapping entry (object 0x6000 (AI Inputs), entry 0x11 (Value))	UINT32	RO	0x6000:11, 16

Index 1A03 AI TxPDO-Map Compact Ch.1

Index (hex)	Name	Meaning	Data type	Flags	Default
1A03:0	AI TxPDO-Map Compact Ch.1	PDO Mapping TxPDO	UINT8	RO	0x01 (1 _{dec})
1A03:01	SubIndex 001	1. PDO Mapping entry (object 0x6000 (AI Inputs), entry 0x11 (Value))	UINT32	RO	0x6000:11, 16

Index 1A04 AI TxPDO-Map Standard Ch.2

Index (hex)	Name	Meaning	Data type	Flags	Default
1A04:0	AI TxPDO-Map Standard Ch.2	PDO Mapping TxPDO	UINT8	RO	0x0B (11 _{dec})
1A04:01	SubIndex 001	1. PDO Mapping entry (object 0x6010 (AI Inputs), entry 0x01 (Underrange))	UINT32	RO	0x6010:01, 1
1A04:02	SubIndex 002	2. PDO Mapping entry (object 0x6010 (AI Inputs), entry 0x02 (Overrange))	UINT32	RO	0x6010:02, 1
1A04:03	SubIndex 003	3. PDO Mapping entry (object 0x6010 (AI Inputs), entry 0x03 (Limit 1))	UINT32	RO	0x6010:03, 2
1A04:04	SubIndex 004	4. PDO Mapping entry (object 0x6010 (AI Inputs), entry 0x05 (Limit 2))	UINT32	RO	0x6010:05, 2
1A04:05	SubIndex 005	5. PDO Mapping entry (object 0x6010 (AI Inputs), entry 0x07 (Error))	UINT32	RO	0x6010:07, 1
1A04:06	SubIndex 006	6. PDO Mapping entry (1 bit align)	UINT32	RO	0x0000:00, 1
1A04:07	SubIndex 007	7. PDO Mapping entry (5 bits align)	UINT32	RO	0x0000:00, 5
1A04:08	SubIndex 008	8. PDO Mapping entry (object 0x6010 (AI Inputs), entry 0x0E (Sync Error))	UINT32	RO	0x6010:0E, 1
1A04:09	SubIndex 009	9. PDO Mapping entry (object 0x6010 (AI Inputs), entry 0x0F (TxPDO State))	UINT32	RO	0x6010:0F, 1
1A04:0A	SubIndex 010	10. PDO Mapping entry (object 0x6010 (AI Inputs), entry 0x10 (TxPDO Toggle))	UINT32	RO	0x6010:10, 1
1A04:0B	SubIndex 011	11. PDO Mapping entry (object 0x6010 (AI Inputs), entry 0x11 (Value))	UINT32	RO	0x6010:11, 16

Index 1A05 AI TxPDO-Map Compact Ch.2

Index (hex)	Name	Meaning	Data type	Flags	Default
1A05:0	AI TxPDO-Map Compact Ch.2	PDO Mapping TxPDO	UINT8	RO	0x01 (1 _{dec})
1A05:01	SubIndex 001	1. PDO Mapping entry (object 0x6010 (AI Inputs), entry 0x11 (Value))	UINT32	RO	0x6010:11, 16

Index 1A10 TxPDO-Map Channels

Index (hex)	Name	Meaning	Data type	Flags	Default
1A10:0	TxPDO-Map Channels	PDO Mapping TxPDO	UINT8	RO	0x02 (2 _{dec})
1A10:01	SubIndex 001	1. PDO Mapping entry (object 0x3101 (Inputs), entry 0x01 (Inputs))	UINT32	RO	0x3101:02, 16
1A10:02	SubIndex 002	2. PDO Mapping entry (object 0x3101 (Inputs), entry 0x02 (Inputs))	UINT32	RO	0x3101:02, 16

Index 1C00 Sync manager type

Index (hex)	Name	Meaning	Data type	Flags	Default
1C00:0	Sync manager type	Using the sync managers	UINT8	RO	0x04 (4 _{dec})
1C00:01	SubIndex 001	Sync-Manager Type Channel 1: Mailbox Write	UINT8	RO	0x01 (1 _{dec})
1C00:02	SubIndex 002	Sync-Manager Type Channel 2: Mailbox Read	UINT8	RO	0x02 (2 _{dec})
1C00:03	SubIndex 003	Sync-Manager Type Channel 3: Process Data Write (Outputs)	UINT8	RO	0x03 (3 _{dec})
1C00:04	SubIndex 004	Sync-Manager Type Channel 4: Process Data Read (Inputs)	UINT8	RO	0x04 (4 _{dec})

Index 1C12 RxPDO assign

Index (hex)	Name	Meaning	Data type	Flags	Default
1C12:0	RxPDO assign	PDO Assign Outputs	UINT8	RW	0x00 (0 _{dec})

Index 1C13 TxPDO assign (only for EL31x2 before rev. EL31x2-0000-0016)

For operation on masters other than TwinCAT it must be ensured that the channels are entered in the PDO assignment ("TxPDO assign", object 0x1C13) successively.

Index (hex)	Name	Meaning	Data type	Flags	Default
1C13:0	TxPDO assign	PDO Assign Inputs	UINT8	RW	0x02 (2 _{dec})
1C13:01	SubIndex 001	1. allocated TxPDO (contains the index of the associated TxPDO mapping object)	UINT16	RW	0x1A02
1C13:02	SubIndex 002	2. allocated TxPDO (contains the index of the associated TxPDO mapping object)	UINT16	RW	0x1A04

Index 1C13 TxPDO assign (only for EL31x2 from rev. EL31x2-0000-0016)

For operation on masters other than TwinCAT it must be ensured that the channels are entered in the PDO assignment ("TxPDO assign", object 0x1C13) successively.

Index (hex)	Name	Meaning	Data type	Flags	Default
1C13:0	TxPDO assign	PDO Assign Inputs	UINT8	RW	0x02 (2 _{dec})
1C13:01	SubIndex 001	1. allocated TxPDO (contains the index of the associated TxPDO mapping object)	UINT16	RW	0x1A00
1C13:02	SubIndex 002	2. allocated TxPDO (contains the index of the associated TxPDO mapping object)	UINT16	RW	0x1A01

Index 1C33*** SM input parameter

Index (hex)	Name	Meaning	Data type	Flags	Default
1C33:0	SM input parameter	Synchronization parameters for the inputs	UINT8	RO	0x20 (32 _{dec})
1C33:01	Sync mode	Current synchronization mode: <ul style="list-style-type: none"> Bit 0 = 0: Free Run Bit 0 = 1: Synchronous with SM 3 event Bit 0-1 = 11: DC with SYNC1 event Bit 15 = 1: Fast mode 	UINT16	RW	0x0022 (34 _{dec})
1C33:02	Cycle time	Cycle time (in ns): <ul style="list-style-type: none"> Free Run: Cycle time of the local timer Synchronous with SM 2 event: Master cycle time DC mode: SYNC0/SYNC1 Cycle Time 	UINT32	RW	0x000F4240 (1000000 _{dec})
1C33:03	Shift time	Time between SYNC0 event and reading of the inputs (in ns, only DC mode)	UINT32	RO	0x000186A0 (100000 _{dec})
1C33:04	Sync modes supported	Supported synchronization modes: <ul style="list-style-type: none"> Bit 0 = 1: Free Run is supported Bit 1: Synchron with SM 3 Event is supported (no Outputs available) Bit 2 = 1: DC mode (SYNC0) Bit 3 = 1: DC mode (SYNC1) Bit 4-5 = 01: Input Shift with local event (Outputs available) Bit 4-5 = 10: Input Shift with SYNC1 Event (no Outputs available) Bit 12 = 1: Legacy Synchron Bit 13 = 1: SM event Bit 14 = 1: dynamic times (measure by writing 1C33:08 [▶ 390]) Bit 15 = 1: Fast mode 	UINT16	RO	0xD00B (53259 _{dec})
1C33:05	Minimum cycle time	Minimum cycle time (in ns)	UINT32	RO	0x000186A0 (100000 _{dec})
1C33:06	Calc and copy time	Time between reading of the inputs and availability of the inputs for the master (in ns, only DC mode)	UINT32	RO	0x00002710 (10000dez)
1C33:08	Command	With this entry the real required process data provision time can be measured. <ul style="list-style-type: none"> 0: Measurement of the local cycle time is stopped 1: Measurement of the local cycle time is started <p>The entries 1C33:03 [▶ 390], 1C33:06 [▶ 390], and 1C33:09 [▶ 390] are updated with the maximum measured values. For a subsequent measurement the measured values are reset</p>	UINT16	RW	0x0000 (0 _{dec})
1C33:09	Maximum Delay time	Time between SYNC1 event and reading of the inputs (in ns, only DC mode)	UINT32	RO	0x000186A0 (100000dez)
1C33:0B	SM event missed counter	Number of missed SM events in OPERATIONAL (DC mode only)	UINT16	RO	0x0000 (0 _{dec})
1C33:0C	Cycle exceeded counter	Number of occasions the cycle time was exceeded in OPERATIONAL (cycle was not completed in time or the next cycle began too early)	UINT16	RO	0x0000 (0 _{dec})
1C33:0D	Shift too short counter	Number of occasions that the interval between SYNC0 and SYNC1 event was too short (DC mode only)	UINT16	RO	0x0000 (0 _{dec})
1C33:20	Sync error	The synchronization was not correct in the last cycle (outputs were output too late; DC mode only)	BOOLEAN	RO	0x00 (0 _{dec})

***) since revision no. EL31xx-00xx-0016

Index F009*** Password protection

Index (hex)	Name	Meaning	Data type	Flags	Default
F009:0	Password protection	Password protection user calibration [▶ 259]	UINT32	RW	0x00000000 (0 _{dec})

***) for EL31xx, see [note \[▶ 259\]](#)

5.6.4.3 EL3144

5.6.4.3.1 Restore object

Index 1011 Restore default parameters

Index (hex)	Name	Meaning	Data type	Flags	Default
1011:0	Restore default parameters [▶ 503]	Restore default parameters	UINT8	RO	0x01 (1 _{dec})
1011:01	SubIndex 001	If this object is set to “0x64616F6C” in the set value dialog, all backup objects are reset to their delivery state.	UINT32	RW	0x00000000 (0 _{dec})

5.6.4.3.2 Configuration data

Index 80n0*** AI settings (for 0 ≤ n ≤ 3)

Index (hex)	Name	Meaning	Data type	Flags	Default
80n0:0	AI Settings	Maximum subindex	UINT8	RO	0x18 (24 _{dec})
80n0:01	Enable user scale [▶ 269]	User scale is active.	BOOLEAN	RW	0x00 (0 _{dec})
80n0:02	Presentation [▶ 244]	0: Signed presentation 1: Unsigned presentation 2: Absolute value with MSB as sign Signed amount representation	BIT3	RW	0x00 (0 _{dec})
80n0:05	Siemens bits [▶ 246]	The S5 bits are displayed in the three low-order bits	BOOLEAN	RW	0x00 (0 _{dec})
80n0:06	Enable filter	Enable filter, which makes PLC-cycle-synchronous data exchange unnecessary	BOOLEAN	RW	0x00 (0 _{dec})
80n0:07	Enable limit 1 [▶ 246]	Limit 1 enabled	BOOLEAN	RW	0x00 (0 _{dec})
80n0:08	Enable limit 2 [▶ 246]	Limit 2 enabled	BOOLEAN	RW	0x00 (0 _{dec})
80n0:0A	Enable user calibration [▶ 269]	Enabling of the user calibration	BOOLEAN	RW	0x00 (0 _{dec})
80n0:0B	Enable vendor calibration [▶ 269]	Enabling of the vendor calibration	BOOLEAN	RW	0x01 (1 _{dec})
80n0:0E	Swap limit bits [▶ 247]	Changing of the Limit Bits	BOOLEAN	RW	0x00 (0 _{dec})
80n0:11	User scale offset [▶ 269]	User scaling offset	INT16	RW	0x0000 (0 _{dec})
80n0:12	User scale gain [▶ 269]	User scaling gain. The gain is represented in fixed-point format, with the factor 2 ⁻¹⁶ . The value 1 corresponds to 65536 _{dec} (0x00010000) and is limited to ±0x7FFFF	INT32	RW	0x00010000 (65536 _{dec})
80n0:13	Limit 1 [▶ 246]	First limit value for setting the status bits	INT16	RW	0x0000 (0 _{dec})
80n0:14	Limit 2 [▶ 246]	Second limit value for setting the status bits	INT16	RW	0x0000 (0 _{dec})
80n0:15	Filter settings	This object determines the digital filter settings, if it is active via Enable filter (index 0x80n0:06 [▶ 392]). The possible settings are sequentially numbered. 0: 50 Hz FIR 1: 60 Hz FIR 2: IIR 1 3: IIR 2 4: IIR 3 5: IIR 4 6: IIR 5 7: IIR 6 8: IIR 7 9: IIR 8	UINT16	RW	0x0000 (0 _{dec})
80n0:17	User calibration offset [▶ 269]	User offset compensation	INT16	RW	0x0000 (0 _{dec})
80n0:18	User calibration gain [▶ 269]	User calibration gain	INT16	RW	0x4000 (16384 _{dec})

***) since revision no. EL31xx-00xx-0016

Filter

The filters of the EL30xx/EL31xx are activated or deactivated via the CoE index 0x8000:15.



The filter characteristics are set via index 0x8000:15

The filter frequencies are set for all channels of the EL30xx/EL31xx terminals centrally via index 0x8000:15 (channel 1). All other corresponding indices 0x80n0:15 have no parameterization function! The latest firmware version (see [status table](#) [▶ 484]) returns an EtherCAT-compliant error message, if the filter characteristics of other channels (index 0x80n0:06, 0x80n0:15) are set.

5.6.4.3.3 Profile-specific objects (0x6000-0xFFFF)

The profile-specific objects have the same meaning for all EtherCAT slaves that support the profile 5001.

5.6.4.3.3.1 Input data

Index 60n0* AI inputs (for 0 ≤ n ≤ 3)**

Index (hex)	Name	Meaning	Data type	Flags	Default
60n0:0	AI inputs	Maximum subindex	INT16	RO	0x11 (17 _{dec})
60n0:01	Underrange	Value below measuring range.	BOOLEAN	RO	0x00 (0 _{dec})
60n0:02	Ovrange	Measuring range exceeded.	BOOLEAN	RO	0x00 (0 _{dec})
60n0:03	Limit 1	Limit value monitoring Limit 1 0: not active 1: value is smaller than limit value 1 2: value is larger than limit value 1 3: Value is equal to limit value 1	BIT2	RO	0x00 (0 _{dec})
60n0:05	Limit 2	Limit value monitoring limit 2 0: not active 1: value is smaller than limit value 2 2: value is larger than limit value 2 3: Value is equal to limit value 2	BIT2	RO	0x00 (0 _{dec})
60n0:07	Error	The error bit is set if the data is invalid (over-range, under-range)	BOOLEAN	RO	0x00 (0 _{dec})
60n0:0E	Sync error	The Sync error bit is only required for DC mode. It indicates whether a synchronization error has occurred during the previous cycle. This means a SYNC signal was triggered in the EL31xx, although no new process data were available (0=OK, 1=NOK).	BOOLEAN	RO	0x00 (0 _{dec})
60n0:0F	TxPDO State	Validity of the data of the associated TxPDO (0 = valid, 1 = invalid).	BOOLEAN	RO	0x00 (0 _{dec})
60n0:10	TxPDO Toggle	The TxPDO toggle is toggled by the slave when the data of the associated TxPDO is updated.	BOOLEAN	RO	0x00 (0 _{dec})
60n0:11	Value	Analog input date	INT16	RO	0x0000 (0 _{dec})

***) since revision no. EL31xx-00xx-0016

5.6.4.3.3.2 Configuration data (vendor-specific)

Index 80nF* AI vendor data (for 0 ≤ n ≤ 3)**

Index (hex)	Name	Meaning	Data type	Flags	Default
80nF:0	AI vendor data	Maximum subindex	UINT8	RO	0x02 (2 _{dec})
80nF:01	Calibration offset	Offset (vendor calibration)	INT16	RW	0x0000 (0 _{dec})
80nF:02	Calibration gain	Gain (vendor calibration)	INT16	RW	0x4000 (16384 _{dec})

***) since revision no. EL31xx-00xx-0016

5.6.4.3.3 Information and diagnostic data

Index 80nE*** AI internal data (for $0 \leq n \leq 3$)

Index (hex)	Name	Meaning	Data type	Flags	Default
80nE:0	AI internal data	Maximum subindex	UINT8	RO	0x01 (1 _{dec})
80nE:01	ADC raw value	ADC raw value	UINT16	RO	-

***) since revision no. EL31xx-00xx-0016

Index F000*** Modular device profile

Index (hex)	Name	Meaning	Data type	Flags	Default
F000:0	Modular device profile	General information for the modular device profile	UINT8	RO	0x02 (2 _{dec})
F000:01	Module index distance	Index spacing of the objects of the individual channels	UINT16	RO	0x0010 (16 _{dec})
F000:02	Maximum number of modules	Number of channels	UINT16	RO	Max. Channels number of the terminal

***) since revision no. EL31xx-00xx-0016

Index F008*** Code word

Index	Name	Meaning	Data type	Flags	Default
F008:0	Code word	reserved	UINT32	RW	0x00000000 (0 _{dec})

***) since revision no. EL31xx-00xx-0016

Index F010*** module list (for $1 \leq n \leq 4$, depends on number of channels)

Index (hex)	Name	Meaning	Data type	Flags	Default
F010:0	Module list	Maximum subindex	UINT8	RW	0x0n
F010:0n	SubIndex 00n	Analog input profile (300)	UINT32	RW	0x0000012C (300 _{dec})

***) since revision no. EL31xx-00xx-0016

5.6.4.3.4 Standard objects

Standard objects (0x1000-0x1FFF)

The standard objects have the same meaning for all EtherCAT slaves.

Index 1000 Device type

Index (hex)	Name	Meaning	Data type	Flags	Default
1000:0	Device type	Device type of the EtherCAT slave: the Lo-Word contains the CoE profile used (5001). The Hi-Word contains the module profile according to the modular device profile.	UINT32	RO	0x012C1389 (19665801 _{dec})

Index 1008 Device name

Index (hex)	Name	Meaning	Data type	Flags	Default
1008:0	Device name	Device name of the EtherCAT slave	STRING	RO	EL31xx

Index 1009 Hardware version

Index (hex)	Name	Meaning	Data type	Flags	Default
1009:0	Hardware version	Hardware version of the EtherCAT slave	STRING	RO	00

Index 100A Software version

Index (hex)	Name	Meaning	Data type	Flags	Default
100A:0	Software version	Firmware version of the EtherCAT slave	STRING	RO	-

Index 1018 Identity

Index (hex)	Name	Meaning	Data type	Flags	Default
1018:0	Identity	Information for identifying the slave	UINT8	RO	0x04 (4 _{dec})
1018:01	Vendor ID	Vendor ID of the EtherCAT slave	UINT32	RO	0x00000002 (2 _{dec})
1018:02	Product code	Product code of the EtherCAT slave	UINT32	RO	0xFFFF3052
1018:03	Revision	Revision number of the EtherCAT slave; the low word (bit 0-15) indicates the special terminal number, the high word (bit 16-31) refers to the device description	UINT32	RO	-
1018:04	Serial number	Serial number of the EtherCAT slave; the low byte (bit 0-7) of the low word contains the year of production, the high byte (bit 8-15) of the low word contains the week of production, the high word (bit 16-31) is 0	UINT32	RO	-

Index 10F0* Backup parameter handling**

Index (hex)	Name	Meaning	Data type	Flags	Default
10F0:0	Backup parameter handling	Information for standardized loading and saving of backup entries	UINT8	RO	0x01 (1 _{dec})
10F0:01	Checksum	Checksum across all backup entries of the EtherCAT slave	UINT32	RO	-

***) since revision no. EL31xx-00xx-0016

Index 1800 AI TxPDO-Par Standard Ch.1

Index (hex)	Name	Meaning	Data type	Flags	Default
1800:0	AI TxPDO-Par Standard Ch.1	PDO parameter TxPDO 1	UINT8	RO	0x06 (6 _{dec})
1800:06	Exclude TxPDOs	Specifies the TxPDOs (index of TxPDO mapping objects) that must not be transferred together with TxPDO 1	OCTET-STRING[2]	RO	01 1A

Index 1801 AI TxPDO-Par Compact Ch.1

Index (hex)	Name	Meaning	Data type	Flags	Default
1801:0	AI TxPDO-Par Compact Ch.1	PDO parameter TxPDO 2	UINT8	RO	0x06 (6 _{dec})
1801:06	Exclude TxPDOs	Specifies the TxPDOs (index of TxPDO mapping objects) that must not be transferred together with TxPDO 2	OCTET-STRING[2]	RO	00 1A

Index 1802 AI TxPDO-Par Standard Ch.2

Index (hex)	Name	Meaning	Data type	Flags	Default
1802:0	AI TxPDO-Par Standard Ch.2	PDO parameter TxPDO 3	UINT8	RO	0x06 (6 _{dec})
1802:06	Exclude TxPDOs	Specifies the TxPDOs (index of TxPDO mapping objects) that must not be transferred together with TxPDO 3	OCTET-STRING[2]	RO	03 1A

Index 1803 AI TxPDO-Par Compact Ch. 2

Index (hex)	Name	Meaning	Data type	Flags	Default
1803:0	AI TxPDO-Par Compact Ch.2	PDO parameter TxPDO 4	UINT8	RO	0x06 (6 _{dec})
1803:06	Exclude TxPDOs	Specifies the TxPDOs (index of TxPDO mapping objects) that must not be transferred together with TxPDO 4	OCTET-STRING[2]	RO	02 1A

Index 1804 AI TxPDO-Par Standard Ch.3

Index (hex)	Name	Meaning	Data type	Flags	Default
1804:0	AI TxPDO-Par Standard Ch.3	PDO parameter TxPDO 5	UINT8	RO	0x06 (6 _{dec})
1804:06	Exclude TxPDOs	Specifies the TxPDOs (index of TxPDO mapping objects) that must not be transferred together with TxPDO 5	OCTET-STRING[2]	RO	05 1A

Index 1805 AI TxPDO-Par Compact Ch. 3

Index (hex)	Name	Meaning	Data type	Flags	Default
1805:0	AI TxPDO-Par Compact Ch.3	PDO parameter TxPDO 6	UINT8	RO	0x06 (6 _{dec})
1805:06	Exclude TxPDOs	Specifies the TxPDOs (index of TxPDO mapping objects) that must not be transferred together with TxPDO 6	OCTET-STRING[2]	RO	04 1A

Index 1806 AI TxPDO-Par Standard Ch.4

Index (hex)	Name	Meaning	Data type	Flags	Default
1806:0	AI TxPDO-Par Standard Ch.4	PDO parameter TxPDO 7	UINT8	RO	0x06 (6 _{dec})
1806:06	Exclude TxPDOs	Specifies the TxPDOs (index of TxPDO mapping objects) that must not be transferred together with TxPDO 7	OCTET-STRING[2]	RO	07 1A

Index 1807 AI TxPDO-Par Compact Ch. 4

Index (hex)	Name	Meaning	Data type	Flags	Default
1807:0	AI TxPDO-Par Compact Ch.4	PDO parameter TxPDO 8	UINT8	RO	0x06 (6 _{dec})
1807:06	Exclude TxPDOs	Specifies the TxPDOs (index of TxPDO mapping objects) that must not be transferred together with TxPDO 8	OCTET-STRING[2]	RO	06 1A

Index 1A00 AI TxPDO-Map Standard Ch.1

Index (hex)	Name	Meaning	Data type	Flags	Default
1A00:0	AI TxPDO-Map Standard Ch.1	PDO Mapping TxPDO	UINT8	RO	0x0B (11 _{dec})
1A00:01	SubIndex 001	1. PDO Mapping entry (object 0x6000 (AI Inputs), entry 0x01 (Underrange))	UINT32	RO	0x6000:01, 1
1A00:02	SubIndex 002	2. PDO Mapping entry (object 0x6000 (AI Inputs), entry 0x02 (Overrange))	UINT32	RO	0x6000:02, 1
1A00:03	SubIndex 003	3. PDO Mapping entry (object 0x6000 (AI Inputs), entry 0x03 (Limit 1))	UINT32	RO	0x6000:03, 2
1A00:04	SubIndex 004	4. PDO Mapping entry (object 0x6000 (AI Inputs), entry 0x05 (Limit 2))	UINT32	RO	0x6000:05, 2
1A00:05	SubIndex 005	5. PDO Mapping entry (object 0x6000 (AI Inputs), entry 0x07 (Error))	UINT32	RO	0x6000:07, 1
1A00:06	SubIndex 006	6. PDO Mapping entry (1 bit align)	UINT32	RO	0x0000:00, 1
1A00:07	SubIndex 007	7. PDO Mapping entry (5 bits align)	UINT32	RO	0x0000:00, 5
1A00:08	SubIndex 008	8. PDO Mapping entry (object 0x6000 (AI Inputs), entry 0x0E (Sync Error))	UINT32	RO	0x6000:0E, 1
1A00:09	SubIndex 009	9. PDO Mapping entry (object 0x6000 (AI Inputs), entry 0x0F (TxPDO State))	UINT32	RO	0x6000:0F, 1
1A00:0A	SubIndex 010	10. PDO Mapping entry (object 0x6000 (AI Inputs), entry 0x10 (TxPDO Toggle))	UINT32	RO	0x6000:10, 1
1A00:0B	SubIndex 011	11. PDO Mapping entry (object 0x6000 (AI Inputs), entry 0x11 (Value))	UINT32	RO	0x6000:11, 16

Index 1A01 AI TxPDO-Map Compact Ch.1

Index (hex)	Name	Meaning	Data type	Flags	Default
1A01:0	AI TxPDO-Map Compact Ch.1	PDO Mapping TxPDO 2	UINT8	RO	0x01 (1 _{dec})
1A01:01	SubIndex 001	1. PDO Mapping entry (object 0x6000 (AI Inputs), entry 0x11 (Value))	UINT32	RO	0x6000:11, 16

Index 1A02 AI TxPDO-Map Standard Ch.

Index (hex)	Name	Meaning	Data type	Flags	Default
1A02:0	AI TxPDO-Map Standard Ch.2	PDO Mapping TxPDO	UINT8	RO	0x0B (11 _{dec})
1A02:01	SubIndex 001	1. PDO Mapping entry (object 0x6010 (AI Inputs), entry 0x01 (Underrange))	UINT32	RO	0x6010:01, 1
1A02:02	SubIndex 002	2. PDO Mapping entry (object 0x6010 (AI Inputs), entry 0x02 (Overrange))	UINT32	RO	0x6010:02, 1
1A02:03	SubIndex 003	3. PDO Mapping entry (object 0x6010 (AI Inputs), entry 0x03 (Limit 1))	UINT32	RO	0x6010:03, 2
1A02:04	SubIndex 004	4. PDO Mapping entry (object 0x6010 (AI Inputs), entry 0x05 (Limit 2))	UINT32	RO	0x6010:05, 2
1A02:05	SubIndex 005	5. PDO Mapping entry (object 0x6010 (AI Inputs), entry 0x07 (Error))	UINT32	RO	0x6010:07, 1
1A02:06	SubIndex 006	6. PDO Mapping entry (1 bit align)	UINT32	RO	0x0000:00, 1
1A02:07	SubIndex 007	7. PDO Mapping entry (5 bits align)	UINT32	RO	0x0000:00, 5
1A02:08	SubIndex 008	8. PDO Mapping entry (object 0x6010 (AI Inputs), entry 0x0E (Sync Error))	UINT32	RO	0x6010:0E, 1
1A02:09	SubIndex 009	9. PDO Mapping entry (object 0x6010 (AI Inputs), entry 0x0F (TxPDO State))	UINT32	RO	0x6010:0F, 1
1A02:0A	SubIndex 010	10. PDO Mapping entry (object 0x6010 (AI Inputs), entry 0x10 (TxPDO Toggle))	UINT32	RO	0x6010:10, 1
1A02:0B	SubIndex 011	11. PDO Mapping entry (object 0x6010 (AI Inputs), entry 0x11 (Value))	UINT32	RO	0x6010:11, 16

Index 1A03 AI TxPDO-Map Compact Ch.2

Index (hex)	Name	Meaning	Data type	Flags	Default
1A03:0	AI TxPDO-Map Compact Ch.2	PDO Mapping TxPDO 4	UINT8	RO	0x01 (1 _{dec})
1A03:01	SubIndex 001	1. PDO Mapping entry (object 0x6010 (AI Inputs), entry 0x11 (Value))	UINT32	RO	0x6010:11, 16

Index 1A04 AI TxPDO-Map Standard Ch.3

Index (hex)	Name	Meaning	Data type	Flags	Default
1A04:0	AI TxPDO-Map Standard Ch.3	PDO Mapping TxPDO	UINT8	RO	0x0B (11 _{dec})
1A04:01	SubIndex 001	1. PDO Mapping entry (object 0x6020 (AI Inputs), entry 0x01 (Underrange))	UINT32	RO	0x6020:01, 1
1A04:02	SubIndex 002	2. PDO Mapping entry (object 0x6020 (AI Inputs), entry 0x02 (Overrange))	UINT32	RO	0x6020:02, 1
1A04:03	SubIndex 003	3. PDO Mapping entry (object 0x6020 (AI Inputs), entry 0x03 (Limit 1))	UINT32	RO	0x6020:03, 2
1A04:04	SubIndex 004	4. PDO Mapping entry (object 0x6020 (AI Inputs), entry 0x05 (Limit 2))	UINT32	RO	0x6020:05, 2
1A04:05	SubIndex 005	5. PDO Mapping entry (object 0x6020 (AI Inputs), entry 0x07 (Error))	UINT32	RO	0x6020:07, 1
1A04:06	SubIndex 006	6. PDO Mapping entry (1 bit align)	UINT32	RO	0x0000:00, 1
1A04:07	SubIndex 007	7. PDO Mapping entry (5 bits align)	UINT32	RO	0x0000:00, 5
1A04:08	SubIndex 008	8. PDO Mapping entry (object 0x6020 (AI Inputs), entry 0x0E (Sync Error))	UINT32	RO	0x6020:0E, 1
1A04:09	SubIndex 009	9. PDO Mapping entry (object 0x6020 (AI Inputs), entry 0x0F (TxPDO State))	UINT32	RO	0x6020:0F, 1
1A04:0A	SubIndex 010	10. PDO Mapping entry (object 0x6020 (AI Inputs), entry 0x10 (TxPDO Toggle))	UINT32	RO	0x6020:10, 1
1A04:0B	SubIndex 011	11. PDO Mapping entry (object 0x6020 (AI Inputs), entry 0x11 (Value))	UINT32	RO	0x6020:11, 16

Index 1A05 AI TxPDO-Map Compact Ch.3

Index (hex)	Name	Meaning	Data type	Flags	Default
1A05:0	AI TxPDO-Map Compact Ch.3	PDO Mapping TxPDO 6	UINT8	RO	0x01 (1 _{dec})
1A05:01	SubIndex 001	1. PDO Mapping entry (object 0x6020 (AI Inputs), entry 0x11 (Value))	UINT32	RO	0x6020:11, 16

Index 1A06 AI TxPDO-Map Standard Ch.4

Index (hex)	Name	Meaning	Data type	Flags	Default
1A06:0	AI TxPDO-Map Standard Ch.4	PDO Mapping TxPDO	UINT8	RO	0x0B (11 _{dec})
1A06:01	SubIndex 001	1. PDO Mapping entry (object 0x6030 (AI Inputs), entry 0x01 (Underrange))	UINT32	RO	0x6030:01, 1
1A06:02	SubIndex 002	2. PDO Mapping entry (object 0x6030 (AI Inputs), entry 0x02 (Overrange))	UINT32	RO	0x6030:02, 1
1A06:03	SubIndex 003	3. PDO Mapping entry (object 0x6030 (AI Inputs), entry 0x03 (Limit 1))	UINT32	RO	0x6030:03, 2
1A06:04	SubIndex 004	4. PDO Mapping entry (object 0x6030 (AI Inputs), entry 0x05 (Limit 2))	UINT32	RO	0x6030:05, 2
1A06:05	SubIndex 005	5. PDO Mapping entry (object 0x6030 (AI Inputs), entry 0x07 (Error))	UINT32	RO	0x6030:07, 1
1A06:06	SubIndex 006	6. PDO Mapping entry (1 bit align)	UINT32	RO	0x0000:00, 1
1A06:07	SubIndex 007	7. PDO Mapping entry (5 bits align)	UINT32	RO	0x0000:00, 5
1A06:08	SubIndex 008	8. PDO Mapping entry (object 0x6030 (AI Inputs), entry 0x0E (Sync Error))	UINT32	RO	0x6030:0E, 1
1A06:09	SubIndex 009	9. PDO Mapping entry (object 0x6030 (AI Inputs), entry 0x0F (TxPDO State))	UINT32	RO	0x6030:0F, 1
1A06:0A	SubIndex 010	10. PDO Mapping entry (object 0x6030 (AI Inputs), entry 0x10 (TxPDO Toggle))	UINT32	RO	0x6030:10, 1
1A06:0B	SubIndex 011	11. PDO Mapping entry (object 0x6030 (AI Inputs), entry 0x11 (Value))	UINT32	RO	0x6030:11, 16

Index 1A07 AI TxPDO-Map Compact Ch.4

Index (hex)	Name	Meaning	Data type	Flags	Default
1A07:0	AI TxPDO-Map Compact Ch.4	PDO Mapping TxPDO 8	UINT8	RO	0x01 (1 _{dec})
1A07:01	SubIndex 001	1. PDO Mapping entry (object 0x6030 (AI Inputs), entry 0x11 (Value))	UINT32	RO	0x6030:11, 16

Index 1C00 Sync manager type

Index (hex)	Name	Meaning	Data type	Flags	Default
1C00:0	Sync manager type	Using the sync managers	UINT8	RO	0x04 (4 _{dec})
1C00:01	SubIndex 001	Sync-Manager Type Channel 1: Mailbox Write	UINT8	RO	0x01 (1 _{dec})
1C00:02	SubIndex 002	Sync-Manager Type Channel 2: Mailbox Read	UINT8	RO	0x02 (2 _{dec})
1C00:03	SubIndex 003	Sync-Manager Type Channel 3: Process Data Write (Outputs)	UINT8	RO	0x03 (3 _{dec})
1C00:04	SubIndex 004	Sync-Manager Type Channel 4: Process Data Read (Inputs)	UINT8	RO	0x04 (4 _{dec})

Index 1C12 RxPDO assign

Index (hex)	Name	Meaning	Data type	Flags	Default
1C12:0	RxPDO assign	PDO Assign Outputs	UINT8	RW	0x00 (0 _{dec})

Index 1C13 TxPDO assign

For operation on masters other than TwinCAT it must be ensured that the channels are entered in the PDO assignment ("TxPDO assign", object 0x1C13) successively.

Index (hex)	Name	Meaning	Data type	Flags	Default
1C13:0	TxPDO assign	PDO Assign Inputs	UINT8	RW	0x04 (4 _{dec})
1C13:01	SubIndex 001	1. zugeordnete TxPDO (enthält den Index des zugehörigen TxPDO Mapping Objekts)	UINT16	RW	0x1A00 (6656 _{dec})
1C13:02	SubIndex 002	2. zugeordnete TxPDO (enthält den Index des zugehörigen TxPDO Mapping Objekts)	UINT16	RW	0x1A02 (6658 _{dec})
1C13:03	SubIndex 003	3. zugeordnete TxPDO (enthält den Index des zugehörigen TxPDO Mapping Objekts)	UINT16	RW	0x1A04 (6660 _{dec})
1C13:04	SubIndex 004	4. zugeordnete TxPDO (enthält den Index des zugehörigen TxPDO Mapping Objekts)	UINT16	RW	0x1A06 (6662 _{dec})

Index 1C33 SM input parameter

Index (hex)	Name	Meaning	Data type	Flags	Default
1C33:0	SM input parameter	Synchronization parameters for the inputs	UINT8	RO	0x20 (32 _{dec})
1C33:01	Sync mode	Current synchronization mode: <ul style="list-style-type: none"> Bit 0 = 0: Free Run Bit 0 = 1: Synchron with SM 2 Event Bit 15 = 0: Standard Bit 15 = 1: FastOp mode (CoE deactivated) 	UINT16	RW	0x0000 (0 _{dec})
1C33:02	Cycle time	Cycle time (in ns): <ul style="list-style-type: none"> Free Run: Cycle time of the local timer Synchronous with SM 2 event: Master cycle time DC-Mode: SYNC0/SYNC1 Cycle Time 	UINT32	RW	0x000F4240 (1000000 _{dec})
1C33:03	Shift time	Time between SYNC0 event and reading of the inputs (in ns, only DC mode)	UINT32	RO	0x00000000 (0 _{dec})
1C33:04	Sync modes supported	Supported synchronization modes: <ul style="list-style-type: none"> Bit 0: free run is supported Bit 1: synchronous with SM 2 event is supported (outputs available) Bit 1: synchronous with SM 3 event is supported (no outputs available) Bit 2-3 = 01: DC mode is supported Bit 4-5 = 01: input shift through local event (outputs available) Bit 4-5 = 10: input shift with SYNC1 event (no outputs available) Bit 14 = 1: dynamic times (measurement through writing of 0x1C33:08) 	UINT16	RO	0xC003 (49155 _{dec})
1C33:05	Minimum cycle time	Minimum cycle time (in ns)	UINT32	RO	0x0000FDE8 (65000 _{dec})
1C33:06	Calc and copy time	Time between reading of the inputs and availability of the inputs for the master (in ns, only DC mode)	UINT32	RO	0x00000000 (0 _{dec})
1C33:07	Minimum delay time		UINT32	RO	0x00000000 (0 _{dec})
1C33:08	Get cycle time	With this entry the real required process data provision time can be measured. <ul style="list-style-type: none"> 0: Measurement of the local cycle time is stopped 1: Measurement of the local cycle time is started The entries 0x1C33:03, 0x1C33:06, 1C33:09 are updated with the maximum measured values. For a subsequent measurement the measured values are reset.	UINT16	RW	0x0000 (0 _{dec})
1C33:09	Maximum delay time	Time between SYNC1 event and reading of the inputs (in ns, only DC mode)	UINT32	RO	0x00000000 (0 _{dec})
1C33:0B	SM event missed counter	Number of missed SM events in OPERATIONAL (DC mode only)	UINT16	RO	0x0000 (0 _{dec})
1C33:0C	Cycle exceeded counter	Number of occasions the cycle time was exceeded in OPERATIONAL (cycle was not completed in time or the next cycle began too early)	UINT16	RO	0x0000 (0 _{dec})
1C33:0D	Shift too short counter	Number of occasions that the interval between SYNC0 and SYNC1 event was too short (DC mode only)	UINT16	RO	0x0000 (0 _{dec})
1C33:20	Sync error	The synchronization was not correct in the last cycle (outputs were output too late; DC mode only)	BOOLEAN	RO	0x00 (0 _{dec})

Index F009*** Password protection

Index (hex)	Name	Meaning	Data type	Flags	Default
F009:0	Password protection	Password protection user calibration [► 259]	UINT32	RW	0x00000000 (0 _{dec})

***) for EL31xx, see [note](#) [► 259]

5.6.5 EL315x

5.6.5.1 EL3151

5.6.5.1.1 Restore object

Index 1011 Restore default parameters

Index (hex)	Name	Meaning	Data type	Flags	Default
1011:0	Restore default parameters [▶ 503]	Restore default parameters	UINT8	RO	0x01 (1 _{dec})
1011:01	SubIndex 001	If this object is set to “0x64616F6C” in the set value dialog, all backup objects are reset to their delivery state.	UINT32	RW	0x00000000 (0 _{dec})

5.6.5.1.2 Configuration data

Index 8000 AI settings

Index (hex)	Name	Meaning	Data type	Flags	Default
8000:0	AI Settings	Maximum subindex	UINT8	RO	0x18 (24 _{dec})
8000:01	Enable user scale [▶ 269]	User scale is active.	BOOLEAN	RW	0x00 (0 _{dec})
8000:02	Presentation [▶ 244]	0: Signed presentation 1: Unsigned presentation 2: Absolute value with MSB as sign Signed amount representation	BIT3	RW	0x00 (0 _{dec})
8000:05	Siemens bits [▶ 246]	The S5 bits are displayed in the three low-order bits	BOOLEAN	RW	0x00 (0 _{dec})
8000:06	Enable filter	Enable filter, which makes PLC-cycle-synchronous data exchange unnecessary	BOOLEAN	RW	0x00 (0 _{dec})
8000:07	Enable limit 1 [▶ 246]	Limit 1 enabled	BOOLEAN	RW	0x00 (0 _{dec})
8000:08	Enable limit 2 [▶ 246]	Limit 2 enabled	BOOLEAN	RW	0x00 (0 _{dec})
8000:0A	Enable user calibration [▶ 269]	Enabling of the user calibration	BOOLEAN	RW	0x00 (0 _{dec})
8000:0B	Enable vendor calibration [▶ 269]	Enabling of the vendor calibration	BOOLEAN	RW	0x01 (1 _{dec})
8000:0E	Swap limit bits [▶ 247]	Changing of the Limit Bits	BOOLEAN	RW	0x00 (0 _{dec})
80n0:11	User scale offset [▶ 269]	User scaling offset	INT16	RW	0x0000 (0 _{dec})
80n0:12	User scale gain [▶ 269]	User scaling gain. The gain is represented in fixed-point format, with the factor 2 ⁻¹⁶ . The value 1 corresponds to 65536 _{dec} (0x00010000) and is limited to ±0x7FFFF	INT32	RW	0x00010000 (65536 _{dec})
80n0:13	Limit 1 [▶ 246]	First limit value for setting the status bits	INT16	RW	0x0000 (0 _{dec})
80n0:14	Limit 2 [▶ 246]	Second limit value for setting the status bits	INT16	RW	0x0000 (0 _{dec})
80n0:15	Filter settings	This object determines the digital filter settings, if it is active via Enable filter (index 0x8000:06 [▶ 402]). The possible settings are sequentially numbered. 0: 50 Hz FIR 1: 60 Hz FIR 2: IIR 1 3: IIR 2 4: IIR 3 5: IIR 4 6: IIR 5 7: IIR 6 8: IIR 7 9: IIR 8	UINT16	RW	0x0000 (0 _{dec})
80n0:17	User calibration offset [▶ 269]	User offset compensation	INT16	RW	0x0000 (0 _{dec})
80n0:18	User calibration gain [▶ 269]	User calibration gain	INT16	RW	0x4000 (16384 _{dec})

***) since revision no. EL31xx-00xx-0016



The filter characteristics are set via index [0x8000:15](#) [\[▶ 402\]](#)

The filter frequencies are set for all channels of the EL31xx terminals centrally via index [0x8000:15](#) [\[▶ 402\]](#) (channel 1). All other corresponding indices 0x80n0:15 have no parameterization function!

5.6.5.1.3 Profile-specific objects (0x6000-0xFFFF)

The profile-specific objects have the same meaning for all EtherCAT slaves that support the profile 5001.

5.6.5.1.3.1 Input data

Index 6000 AI inputs

Index (hex)	Name	Meaning	Data type	Flags	Default
6000:0	AI inputs	Maximum subindex	INT16	RO	0x11 (17 _{dec})
6000:01	Underrange	Value below measuring range.	BOOLEAN	RO	0x00 (0 _{dec})
6000:02	Overrange	Measuring range exceeded.	BOOLEAN	RO	0x00 (0 _{dec})
6000:03	Limit 1	Limit value monitoring Limit 1 0: not active 1: value is smaller than limit value 1 2: value is larger than limit value 1 3: Value is equal to limit value 1	BIT2	RO	0x00 (0 _{dec})
6000:05	Limit 2	Limit value monitoring limit 2 0: not active 1: value is smaller than limit value 2 2: value is larger than limit value 2 3: Value is equal to limit value 2	BIT2	RO	0x00 (0 _{dec})
6000:07	Error	The error bit is set if the data is invalid (over-range, under-range)	BOOLEAN	RO	0x00 (0 _{dec})
6000:0E	Sync error	The Sync error bit is only required for DC mode. It indicates whether a synchronization error has occurred during the previous cycle. This means a SYNC signal was triggered in the EL31xx, although no new process data were available (0=OK, 1=NOK).	BOOLEAN	RO	0x00 (0 _{dec})
6000:0F	TxPDO State	Validity of the data of the associated TxPDO (0 = valid, 1 = invalid).	BOOLEAN	RO	0x00 (0 _{dec})
60n0:10	TxPDO Toggle	The TxPDO toggle is toggled by the slave when the data of the associated TxPDO is updated.	BOOLEAN	RO	0x00 (0 _{dec})
60n0:11	Value	Analog input date	INT16	RO	0x0000 (0 _{dec})

5.6.5.1.3.2 Configuration data (vendor-specific)

Index 800F AI vendor data

Index (hex)	Name	Meaning	Data type	Flags	Default
800F:0	AI vendor data	Maximum subindex	UINT8	RO	0x02 (2 _{dec})
800F:01	Calibration offset	Offset (vendor calibration)	INT16	RW	0x0000 (0 _{dec})
800F:02	Calibration gain	Gain (vendor calibration)	INT16	RW	0x4000 (16384 _{dec})

5.6.5.1.3.3 Information and diagnostic data

Index 800E AI internal data

Index (hex)	Name	Meaning	Data type	Flags	Default
800E:0	AI internal data	Maximum subindex	UINT8	RO	0x01 (1 _{dec})
800E:01	ADC raw value	ADC raw value	UINT16	RO	-

Index F000*** Modular device profile

Index (hex)	Name	Meaning	Data type	Flags	Default
F000:0	Modular device profile	General information for the modular device profile	UINT8	RO	0x02 (2 _{dec})
F000:01	Module index distance	Index spacing of the objects of the individual channels	UINT16	RO	0x0010 (16 _{dec})
F000:02	Maximum number of modules	Number of channels	UINT16	RO	<i>Max. Channels number of the terminal</i>

***) since revision no. EL31xx-00xx-0016

Index F008* Code word**

Index	Name	Meaning	Data type	Flags	Default
F008:0	Code word	reserved	UINT32	RW	0x00000000 (0 _{dec})

***) since revision no. EL31xx-00xx-0016

Index F009* Password protection**

Index (hex)	Name	Meaning	Data type	Flags	Default
F009:0	Password protection	Password protection user calibration [▶ 259]	UINT32	RW	0x00000000 (0 _{dec})

***) for EL31xx, see [note \[\[▶ 259\]\(#\)\]](#)

Index F010* module list (for $1 \leq n \leq 4$, depends on number of channels)**

Index (hex)	Name	Meaning	Data type	Flags	Default
F010:0	Module list	Maximum subindex	UINT8	RW	0x0n
F010:0n	SubIndex 00n	Analog input profile (300)	UINT32	RW	0x0000012C (300 _{dec})

***) since revision no. EL31xx-00xx-0016

5.6.5.1.4 Standard objects**Standard objects (0x1000-0x1FFF)**

The standard objects have the same meaning for all EtherCAT slaves.

Index 1000 Device type

Index (hex)	Name	Meaning	Data type	Flags	Default
1000:0	Device type	Device type of the EtherCAT slave: the Lo-Word contains the CoE profile used (5001). The Hi-Word contains the module profile according to the modular device profile.	UINT32	RO	0x012C1389 (19665801 _{dec})

Index 1008 Device name

Index (hex)	Name	Meaning	Data type	Flags	Default
1008:0	Device name	Device name of the EtherCAT slave	STRING	RO	EL31xx

Index 1009 Hardware version

Index (hex)	Name	Meaning	Data type	Flags	Default
1009:0	Hardware version	Hardware version of the EtherCAT slave	STRING	RO	00

Index 100A Software version

Index (hex)	Name	Meaning	Data type	Flags	Default
100A:0	Software version	Firmware version of the EtherCAT slave	STRING	RO	-

Index 1018 Identity

Index (hex)	Name	Meaning	Data type	Flags	Default
1018:0	Identity	Information for identifying the slave	UINT8	RO	0x04 (4 _{dec})
1018:01	Vendor ID	Vendor ID of the EtherCAT slave	UINT32	RO	0x00000002 (2 _{dec})
1018:02	Product code	Product code of the EtherCAT slave	UINT32	RO	0xFFFF3052
1018:03	Revision	Revision number of the EtherCAT slave; the low word (bit 0-15) indicates the special terminal number, the high word (bit 16-31) refers to the device description	UINT32	RO	-
1018:04	Serial number	Serial number of the EtherCAT slave; the low byte (bit 0-7) of the low word contains the year of production, the high byte (bit 8-15) of the low word contains the week of production, the high word (bit 16-31) is 0	UINT32	RO	-

Index 10F0* Backup parameter handling**

Index (hex)	Name	Meaning	Data type	Flags	Default
10F0:0	Backup parameter handling	Information for standardized loading and saving of backup entries	UINT8	RO	0x01 (1 _{dec})
10F0:01	Checksum	Checksum across all backup entries of the EtherCAT slave	UINT32	RO	-

***) since revision no. EL31xx-00xx-0016

Index 1800 AI TxPDO-Par Standard Ch.1

Index (hex)	Name	Meaning	Data type	Flags	Default
1800:0	AI TxPDO-Par Standard Ch.1	PDO parameter TxPDO 1	UINT8	RO	0x06 (6 _{dec})
1800:06	Exclude TxPDOs	Specifies the TxPDOs (index of TxPDO mapping objects) that must not be transferred together with TxPDO 1	OCTET-STRING[2]	RO	01 1A

Index 1801 AI TxPDO-Par Compact Ch.1

Index (hex)	Name	Meaning	Data type	Flags	Default
1801:0	AI TxPDO-Par Compact Ch.1	PDO parameter TxPDO 2	UINT8	RO	0x06 (6 _{dec})
1801:06	Exclude TxPDOs	Specifies the TxPDOs (index of TxPDO mapping objects) that must not be transferred together with TxPDO 2	OCTET-STRING[2]	RO	00 1A

Index 1A0n AI TxPDO-Map Standard (for n = 0, 2, 4, 6; p = 0, 1, 2, 3; depending on the number of channels, *not applicable for EL31x2*)

Index (hex)	Name	Meaning	Data type	Flags	Default
1A0n:0	AI TxPDO-Map standard	PDO Mapping TxPDO	UINT8	RO	0x0B (11 _{dec})
1A0n:01	SubIndex 001	1. PDO Mapping entry (object 0x60p0 (AI Inputs), entry 0x01 (Underrange))	UINT32	RO	0x60p0:01, 1
1A0n:02	SubIndex 002	2. PDO Mapping entry (object 0x60p0 (AI Inputs), entry 0x02 (Overrange))	UINT32	RO	0x60p0:02, 1
1A0n:03	SubIndex 003	3. PDO Mapping entry (object 0x60p0 (AI Inputs), entry 0x03 (Limit 1))	UINT32	RO	0x60p0:03, 2
1A0n:04	SubIndex 004	4. PDO Mapping entry (object 0x60p0 (AI Inputs), entry 0x05 (Limit 2))	UINT32	RO	0x60p0:05, 2
1A0n:05	SubIndex 005	5. PDO Mapping entry (object 0x60p0 (AI Inputs), entry 0x07 (Error))	UINT32	RO	0x60p0:07, 2
1A0n:06	SubIndex 006	6. PDO Mapping entry (1 bit align)	UINT32	RO	0x0000:00, 1
1A0n:07	SubIndex 007	7. PDO Mapping entry (5 bits align)	UINT32	RO	0x0000:00, 5
1A0n:08	SubIndex 008	8. PDO Mapping entry (object 0x1C32 (SM input parameter), entry 0x20 (Sync error))	UINT32	RO	0x1C32:20, 1
1A0n:09	SubIndex 009	9. PDO Mapping entry (object 0x180n (AI TxPDO-Par standard), entry 0x07 (TxPDO State))	UINT32	RO	0x180n:07, 1
1A0n:0A	SubIndex 010	10. PDO Mapping entry (object 0x180n (AI TxPDO-Par standard), entry 0x09 (TxPDO Toggle))	UINT32	RO	0x180n:09, 1
1A0n:0B	SubIndex 011	11. PDO Mapping entry (object 0x60p0 (AI Inputs), entry 0x11 (Value))	UINT32	RO	0x60p0:11, 16

Index 1A01 AI TxPDO-Map Compact Ch.1

Index (hex)	Name	Meaning	Data type	Flags	Default
1A01:0	AI TxPDO-Map Compact Ch.1	PDO Mapping TxPDO 2	UINT8	RO	0x01 (1 _{dec})
1A01:01	SubIndex 001	1. PDO Mapping entry (object 0x6000 (AI Inputs), entry 0x11 (Value))	UINT32	RO	0x6000:11, 16

Index 1C00 Sync manager type

Index (hex)	Name	Meaning	Data type	Flags	Default
1C00:0	Sync manager type	Using the sync managers	UINT8	RO	0x04 (4 _{dec})
1C00:01	SubIndex 001	Sync-Manager Type Channel 1: Mailbox Write	UINT8	RO	0x01 (1 _{dec})
1C00:02	SubIndex 002	Sync-Manager Type Channel 2: Mailbox Read	UINT8	RO	0x02 (2 _{dec})
1C00:03	SubIndex 003	Sync-Manager Type Channel 3: Process Data Write (Outputs)	UINT8	RO	0x03 (3 _{dec})
1C00:04	SubIndex 004	Sync-Manager Type Channel 4: Process Data Read (Inputs)	UINT8	RO	0x04 (4 _{dec})

Index 1C12 RxPDO assign

Index (hex)	Name	Meaning	Data type	Flags	Default
1C12:0	RxPDO assign	PDO Assign Outputs	UINT8	RW	0x00 (0 _{dec})

Index 1C13 TxPDO assign (not applicable for EL31x2)

For operation on masters other than TwinCAT it must be ensured that the channels are entered in the PDO assignment ("TxPDO assign", object 0x1C13) successively.

Index (hex)	Name	Meaning	Data type	Flags	Default
1C13:0	TxPDO assign	PDO Assign Inputs	UINT8	RW	0x04 (4 _{dec})
1C13:01	SubIndex 001	1. allocated TxPDO (contains the index of the associated TxPDO mapping object)	UINT16	RW	0x1A00 (6656 _{dec})
1C13:02*	SubIndex 002	2. allocated TxPDO (contains the index of the associated TxPDO mapping object)	UINT16	RW	0x1A02 (6658 _{dec})
1C13:03*	SubIndex 003	3. allocated TxPDO (contains the index of the associated TxPDO mapping object)	UINT16	RW	0x1A04 (6660 _{dec})
1C13:04*	SubIndex 004	4. allocated TxPDO (contains the index of the associated TxPDO mapping object)	UINT16	RW	0x1A06 (6662 _{dec})

*) only for EL31x4

Index 1C33 SM input parameter

Index (hex)	Name	Meaning	Data type	Flags	Default
1C33:0	SM input parameter	Synchronization parameters for the inputs	UINT8	RO	0x20 (32 _{dec})
1C33:01	Sync mode	Current synchronization mode: <ul style="list-style-type: none"> • Bit 0 = 0: Free Run • Bit 0 = 1: Synchron with SM 2 Event • Bit 15 = 0: Standard • Bit 15 = 1: FastOp mode (CoE deactivated) 	UINT16	RW	0x0000 (0 _{dec})
1C33:02	Cycle time	Cycle time (in ns): <ul style="list-style-type: none"> • Free Run: Cycle time of the local timer • Synchronous with SM 2 event: Master cycle time • DC-Mode: SYNC0/SYNC1 Cycle Time 	UINT32	RW	0x000F4240 (1000000 _{dec})
1C33:03	Shift time	Time between SYNC0 event and reading of the inputs (in ns, only DC mode)	UINT32	RO	0x00000000 (0 _{dec})
1C33:04	Sync modes supported	Supported synchronization modes: <ul style="list-style-type: none"> • Bit 0: free run is supported • Bit 1: synchronous with SM 2 event is supported (outputs available) • Bit 1: synchronous with SM 3 event is supported (no outputs available) • Bit 2-3 = 01: DC mode is supported • Bit 4-5 = 01: input shift through local event (outputs available) • Bit 4-5 = 10: input shift with SYNC1 event (no outputs available) • Bit 14 = 1: dynamic times (measurement through writing of 0x1C33:08) 	UINT16	RO	0xC003 (49155 _{dec})
1C33:05	Minimum cycle time	Minimum cycle time (in ns)	UINT32	RO	0x0000FDE8 (65000 _{dec})
1C33:06	Calc and copy time	Time between reading of the inputs and availability of the inputs for the master (in ns, only DC mode)	UINT32	RO	0x00000000 (0 _{dec})
1C33:07	Minimum delay time		UINT32	RO	0x00000000 (0 _{dec})
1C33:08	Get cycle time	With this entry the real required process data provision time can be measured. <ul style="list-style-type: none"> • 0: Measurement of the local cycle time is stopped • 1: Measurement of the local cycle time is started The entries 0x1C33:03, 0x1C33:06, 1C33:09 are updated with the maximum measured values. For a subsequent measurement the measured values are reset.	UINT16	RW	0x0000 (0 _{dec})
1C33:09	Maximum delay time	Time between SYNC1 event and reading of the inputs (in ns, only DC mode)	UINT32	RO	0x00000000 (0 _{dec})
1C33:0B	SM event missed counter	Number of missed SM events in OPERATIONAL (DC mode only)	UINT16	RO	0x0000 (0 _{dec})
1C33:0C	Cycle exceeded counter	Number of occasions the cycle time was exceeded in OPERATIONAL (cycle was not completed in time or the next cycle began too early)	UINT16	RO	0x0000 (0 _{dec})
1C33:0D	Shift too short counter	Number of occasions that the interval between SYNC0 and SYNC1 event was too short (DC mode only)	UINT16	RO	0x0000 (0 _{dec})
1C33:20	Sync error	The synchronization was not correct in the last cycle (outputs were output too late; DC mode only)	BOOLEAN	RO	0x00 (0 _{dec})

Index F009 password protection

Index (hex)	Name	Meaning	Data type	Flags	Default
F009:0	Password protection ▶ 259	Password protection for user calibration	UINT32	RW	0x00000000 (0 _{dec})

5.6.5.2 EL3152

5.6.5.2.1 Restore object

Index 1011 Restore default parameters

Index (hex)	Name	Meaning	Data type	Flags	Default
1011:0	Restore default parameters ▶ 503	Restore default parameters	UINT8	RO	0x01 (1 _{dec})
1011:01	SubIndex 001	If this object is set to "0x64616F6C" in the set value dialog, all backup objects are reset to their delivery state.	UINT32	RW	0x00000000 (0 _{dec})

5.6.5.2.2 Configuration data

Index 40n0* producer code word (for n = 4 [channel 1], n = 8 [channel 2])

● Producer code word

i The vendor reserves the authority for the basic calibration of the terminals. The Producer code word is therefore at present reserved.

*) up to rev. no. EL31x2-0000-0016, only for EL31x2, see [note regarding EL31x2 terminals before rev. no. EL31x2-0000-0016 ▶ 278](#)

Index 40n1 ADC raw value (for n = 4 [channel 1], n = 8 [channel 2])

(up to rev. no. EL31x2-0000-0016, only for EL31x2, see [note ▶ 278](#))

Index (hex)	Name	Meaning	Flags	Default
40n1:0	ADC raw value	Length of this object	RO	1 _{dec}
40n1:01	ADC rawdata	This is the circuit's raw ADC value. It is converted to a measurement through a calculation with the gain and offset from the calibration.	RO	-

Index 40n1 feature bits (for n = 6 [channel 1], n = A [channel 2])

(up to rev. no. EL31x2-0000-0016, only for EL31x2, see [note ▶ 278](#))

Index (hex)	Name	Meaning	Flags	Default	
40n1:0	Feature bits	Length of this object	RW	3 _{dec}	
40n1:01	Enable user scale	TRUE	User scaling (index 40n2 ▶ 409) is active.	RW	FALSE
		FALSE	The user scaling is deactivated.		
40n1:02	Enable absolute with MSB as sign	TRUE	The measured value is output in magnitude-sign format.	RW	FALSE
			EL3102		
		EL3142-0010	+10 mA = 0x7FFF -10 mA = 0xFFFF		
		FALSE	The measured value is output as signed integer in the two's complement		
EL3142-0010	+10 mA = 0x7FFF -10 mA = 0x8001				
40n1:03	Enable filter	TRUE	The digital filter (index 40n5 ▶ 409 , filter settings) is active. The analog values are not converted synchronously with the exchange of process data, but in accordance with the filter setting.	RW	FALSE
		FALSE	The analog values are converted synchronously with the exchange of process data; a digital filter is not active.		

Index 40n2 calibration data (for n = 4 [channel 1], n = 8 [channel 2])

(up to rev. no. EL31x2-0000-0016, only for EL31x2, see [note ▶ 278](#))

Index (hex)	Name	Meaning	Flags	Default
40n2:0	Calibration data	Length of this object	RW	2 _{dec}
40n2:01	Offset 16 bit signed integer	These objects are used to trim the tolerances of the components to determine the measured value. The values can only be changed if the producer code word is set (index 40n0 [▶ 408]).	Offset trim channel 1/ channel 2	0xXXXX
40n2:02	Gain 16 bit unsigned integer		Gain trim channel 1/ channel 2	0xXXXX

**Index 40n2 user scale (for n = 4 [channel 1], n = A [channel 2])
(Feature bit 40n1:01 enabled) 40n1:01 [▶ 408]**

(up to rev. no. EL31x2-0000-0016, only for EL31x2, see note [▶ 278])

Index (hex)	Name	Meaning	Flags	Default
40n2:0	User scale	Length of this object	RW	2 _{dec}
40n2:01	Offset 16 bit signed integer	These objects contain the user scaling.	Offset trim, user scaling channel 1/ channel 2	0x0000
40n2:02	Gain 32 bit signed integer	The scaling is enabled via 40n1:01 [▶ 408].	Gain trim, user scaling channel 1/ channel 2 The gain is represented in fixed-point format, with the factor 2 ⁻¹⁶ . A value of 1 for the gain factor therefore corresponds to 65536 _{dec} (0x00010000).	0x00010000

**Index 40n5 filter settings (for n = 4 [channel 1], n = A [channel 2])
(Feature bit 40n1:03 enabled)40n1:03 [▶ 408]**

(up to rev. no. EL31x2-0000-0016, only for EL31x2, see note [▶ 278])

Enum value	Decimal value	Description	Default
50 Hz FIR	0	50 Hz FIR over 32 values; 50 Hz interferences are suppressed with 60 dB	50 Hz FIR (0 _{dec})
60 Hz FIR	1	60 Hz FIR over 32 values; 60 Hz interferences are suppressed with 40 dB	
IIR Level 1	2	Recursive filter, t _{rise_90%} ** = 0.72 ms	
IIR Level 2	3	Recursive filter, t _{rise_90%} = 1.62 ms	
IIR Level 3	4	Recursive filter, t _{rise_90%} = 3.24 ms	
IIR Level 4	5	Recursive filter, t _{rise_90%} = 6.48 ms	
IIR Level 5	6	Recursive filter, t _{rise_90%} = 12.96 ms	
IIR Level 6	7	Recursive filter, t _{rise_90%} = 25.92 ms	
IIR Level 7	8	Recursive filter, t _{rise_90%} = 51.84 ms	
IIR Level 8	9	Recursive filter, t _{rise_90%} = 103.68 ms	

**) step in rise time [t_{rise_90%}]

Index 80n0*** AI settings (for $0 \leq n \leq 1$)

Index (hex)	Name	Meaning	Data type	Flags	Default
80n0:0	AI Settings	Maximum subindex	UINT8	RO	0x18 (24 _{dec})
80n0:01	Enable user scale [▶ 269]	User scale is active.	BOOLEAN	RW	0x00 (0 _{dec})
80n0:02	Presentation [▶ 244]	0: Signed presentation 1: Unsigned presentation 2: Absolute value with MSB as sign Signed amount representation	BIT3	RW	0x00 (0 _{dec})
80n0:05	Siemens bits [▶ 246]	The S5 bits are displayed in the three low-order bits	BOOLEAN	RW	0x00 (0 _{dec})
80n0:06	Enable filter	Enable filter, which makes PLC-cycle-synchronous data exchange unnecessary	BOOLEAN	RW	0x00 (0 _{dec})
80n0:07	Enable limit 1 [▶ 246]	Limit 1 enabled	BOOLEAN	RW	0x00 (0 _{dec})
80n0:08	Enable limit 2 [▶ 246]	Limit 2 enabled	BOOLEAN	RW	0x00 (0 _{dec})
80n0:0A	Enable user calibration [▶ 269]	Enabling of the user calibration	BOOLEAN	RW	0x00 (0 _{dec})
80n0:0B	Enable vendor calibration [▶ 269]	Enabling of the vendor calibration	BOOLEAN	RW	0x01 (1 _{dec})
80n0:0E	Swap limit bits [▶ 247]	Changing of the Limit Bits	BOOLEAN	RW	0x00 (0 _{dec})
80n0:11	User scale offset [▶ 269]	User scaling offset	INT16	RW	0x0000 (0 _{dec})
80n0:12	User scale gain [▶ 269]	User scaling gain. The gain is represented in fixed-point format, with the factor 2^{-16} . The value 1 corresponds to 65536 _{dec} (0x00010000) and is limited to $\pm 0x7FFFF$	INT32	RW	0x00010000 (65536 _{dec})
80n0:13	Limit 1 [▶ 246]	First limit value for setting the status bits	INT16	RW	0x0000 (0 _{dec})
80n0:14	Limit 2 [▶ 246]	Second limit value for setting the status bits	INT16	RW	0x0000 (0 _{dec})
80n0:15	Filter settings	This object determines the digital filter settings, if it is active via Enable filter (index 0x80n0:06 [▶ 410]). The possible settings are sequentially numbered. 0: 50 Hz FIR 1: 60 Hz FIR 2: IIR 1 3: IIR 2 4: IIR 3 5: IIR 4 6: IIR 5 7: IIR 6 8: IIR 7 9: IIR 8	UINT16	RW	0x0000 (0 _{dec})
80n0:17	User calibration offset [▶ 269]	User offset compensation	INT16	RW	0x0000 (0 _{dec})
80n0:18	User calibration gain [▶ 269]	User calibration gain	INT16	RW	0x4000 (16384 _{dec})

***) since revision no. EL31xx-00xx-0016



The filter characteristics are set via index **0x8000:15 [▶ 410]**

The filter frequencies are set for all channels of the EL31xx terminals centrally via index **0x8000:15 [▶ 410]** (channel 1). All other corresponding indices 0x80n0:15 have no parameterization function!

5.6.5.2.3 Profile-specific objects (0x6000-0xFFFF)

The profile-specific objects have the same meaning for all EtherCAT slaves that support the profile 5001.

5.6.5.2.3.1 Input data

Index 3101 inputs (channel 1)

(up to rev. no. EL31x2-0000-0016, only for EL31x2, see [note \[► 278\]](#))

Index (hex)	Name	Meaning	Flags	Default
3101:0	Inputs	Length of this object	RO	2 _{dec}
3101:01	Status	Status byte [► 254] channel 1	RO	-
3101:02	Value	Input process data channel 1	RO	-

Index 3102 inputs (channel 2)

(up to rev. no. EL31x2-0000-0016, only for EL31x2, see [note \[► 278\]](#))

Index (hex)	Name	Meaning	Flags	Default
3102:0	Inputs	Length of this object	RO	2 _{dec}
3102:01	Status	Status byte [► 254] channel 2	RO	-
3102:02	Value	Input process data channel 2	RO	-

Index 60n0*** AI inputs (for 0 ≤ n ≤ 1)

Index (hex)	Name	Meaning	Data type	Flags	Default
60n0:0	AI inputs	Maximum subindex	INT16	RO	0x11 (17 _{dec})
60n0:01	Underrange	Value below measuring range.	BOOLEAN	RO	0x00 (0 _{dec})
60n0:02	Overrange	Measuring range exceeded.	BOOLEAN	RO	0x00 (0 _{dec})
60n0:03	Limit 1	Limit value monitoring Limit 1 0: not active 1: value is smaller than limit value 1 2: value is larger than limit value 1 3: Value is equal to limit value 1	BIT2	RO	0x00 (0 _{dec})
60n0:05	Limit 2	Limit value monitoring limit 2 0: not active 1: value is smaller than limit value 2 2: value is larger than limit value 2 3: Value is equal to limit value 2	BIT2	RO	0x00 (0 _{dec})
60n0:07	Error	The error bit is set if the data is invalid (over-range, under-range)	BOOLEAN	RO	0x00 (0 _{dec})
60n0:0E	Sync error	The Sync error bit is only required for DC mode. It indicates whether a synchronization error has occurred during the previous cycle. This means a SYNC signal was triggered in the EL31xx, although no new process data were available (0=OK, 1=NOK).	BOOLEAN	RO	0x00 (0 _{dec})
60n0:0F	TxPDO State	Validity of the data of the associated TxPDO (0 = valid, 1 = invalid).	BOOLEAN	RO	0x00 (0 _{dec})
60n0:10	TxPDO Toggle	The TxPDO toggle is toggled by the slave when the data of the associated TxPDO is updated.	BOOLEAN	RO	0x00 (0 _{dec})
60n0:11	Value	Analog input date	INT16	RO	0x0000 (0 _{dec})

***) since revision no. EL31xx-00xx-0016

Index 6401 inputs (channels 1 & 2)

(up to rev. no. EL31x2-0000-0016, only for EL31x2, see [note \[► 278\]](#))

Index (hex)	Name	Meaning	Flags	Default
6401:0	Inputs	Length of this object	RO	2 _{dec}
6401:01	Value channel 1	Input process data channel 1	RO	-
6401:02	Value channel 2	Input process data channel 2	RO	-

5.6.5.2.3.2 Configuration data (vendor-specific)

Index 80nF*** AI vendor data (for $0 \leq n \leq 1$)

Index (hex)	Name	Meaning	Data type	Flags	Default
80nF:0	AI vendor data	Maximum subindex	UINT8	RO	0x02 (2 _{dec})
80nF:01	Calibration offset	Offset (vendor calibration)	INT16	RW	0x0000 (0 _{dec})
80nF:02	Calibration gain	Gain (vendor calibration)	INT16	RW	0x4000 (16384 _{dec})

***) since revision no. EL31xx-00xx-0016

5.6.5.2.3.3 Information and diagnostic data

Index 80nE*** AI internal data (for $0 \leq n \leq 1$)

Index (hex)	Name	Meaning	Data type	Flags	Default
80nE:0	AI internal data	Maximum subindex	UINT8	RO	0x01 (1 _{dec})
80nE:01	ADC raw value	ADC raw value	UINT16	RO	-

***) since revision no. EL31xx-00xx-0016

Index F000*** Modular device profile

Index (hex)	Name	Meaning	Data type	Flags	Default
F000:0	Modular device profile	General information for the modular device profile	UINT8	RO	0x02 (2 _{dec})
F000:01	Module index distance	Index spacing of the objects of the individual channels	UINT16	RO	0x0010 (16 _{dec})
F000:02	Maximum number of modules	Number of channels	UINT16	RO	<i>Max. Channels number of the terminal</i>

***) since revision no. EL31xx-00xx-0016

Index F008*** Code word

Index	Name	Meaning	Data type	Flags	Default
F008:0	Code word	reserved	UINT32	RW	0x00000000 (0 _{dec})

***) since revision no. EL31xx-00xx-0016

Index F009*** Password protection

Index (hex)	Name	Meaning	Data type	Flags	Default
F009:0	Password protection	Password protection user calibration [► 259]	UINT32	RW	0x00000000 (0 _{dec})

***) for EL31xx, see [note \[► 259\]](#)

Index F010*** module list (for $1 \leq n \leq 4$, depends on number of channels)

Index (hex)	Name	Meaning	Data type	Flags	Default
F010:0	Module list	Maximum subindex	UINT8	RW	0x0n
F010:0n	SubIndex 00n	Analog input profile (300)	UINT32	RW	0x0000012C (300 _{dec})

***) since revision no. EL31xx-00xx-0016

5.6.5.2.4 Standard objects

Standard objects (0x1000-0x1FFF)

The standard objects have the same meaning for all EtherCAT slaves.

Index 1000 Device type

Index (hex)	Name	Meaning	Data type	Flags	Default
1000:0	Device type	Device type of the EtherCAT slave: the Lo-Word contains the CoE profile used (5001). The Hi-Word contains the module profile according to the modular device profile.	UINT32	RO	0x00001389 (5001 _{dec})

Index 1008 Device name

Index (hex)	Name	Meaning	Data type	Flags	Default
1008:0	Device name	Device name of the EtherCAT slave	STRING	RO	EL31xx

Index 1009 Hardware version

Index (hex)	Name	Meaning	Data type	Flags	Default
1009:0	Hardware version	Hardware version of the EtherCAT slave	STRING	RO	00

Index 100A Software version

Index (hex)	Name	Meaning	Data type	Flags	Default
100A:0	Software version	Firmware version of the EtherCAT slave	STRING	RO	-

Index 1018 Identity

Index (hex)	Name	Meaning	Data type	Flags	Default
1018:0	Identity	Information for identifying the slave	UINT8	RO	0x04 (4 _{dec})
1018:01	Vendor ID	Vendor ID of the EtherCAT slave	UINT32	RO	0x00000002 (2 _{dec})
1018:02	Product code	Product code of the EtherCAT slave	UINT32	RO	0xFFFF3052
1018:03	Revision	Revision number of the EtherCAT slave; the low word (bit 0-15) indicates the special terminal number, the high word (bit 16-31) refers to the device description	UINT32	RO	-
1018:04	Serial number	Serial number of the EtherCAT slave; the low byte (bit 0-7) of the low word contains the year of production, the high byte (bit 8-15) of the low word contains the week of production, the high word (bit 16-31) is 0	UINT32	RO	-

Index 10F0*** Backup parameter handling

Index (hex)	Name	Meaning	Data type	Flags	Default
10F0:0	Backup parameter handling	Information for standardized loading and saving of backup entries	UINT8	RO	0x01 (1 _{dec})
10F0:01	Checksum	Checksum across all backup entries of the EtherCAT slave	UINT32	RO	-

***) since revision no. EL31xx-00xx-0016

Index 1800 TxPDO-Par Ch.1

Index (hex)	Name	Meaning	Data type	Flags	Default
1800:0	TxPDO-Par Ch.1	PDO Parameter TxPDO	UINT8	RO	0x06 (6 _{dec})
1800:06	Exclude TxPDOs	Hier sind die TxPDOs (Index der TxPDO Mapping Objekte) angegeben, die nicht zusammen mit TxPDO 1 übertragen werden dürfen	OCTET-STRING[2]	RO	02 1A 03 1A 07 1A 10 1A

Index 1801 TxPDO-Par Ch.2

Index (hex)	Name	Meaning	Data type	Flags	Default
1801:0	TxPDO-Par Ch.2	PDO Parameter TxPDO	UINT8	RO	0x06 (6 _{dec})
1801:06	Exclude TxPDOs	Hier sind die TxPDOs (Index der TxPDO Mapping Objekte) angegeben, die nicht zusammen mit TxPDO 2 übertragen werden dürfen	OCTET-STRING[2]	RO	04 1A 05 1A 09 1A 10 1A

Index 1802 AI TxPDO-Par Standard Ch.2

Index (hex)	Name	Meaning	Data type	Flags	Default
1802:0	AI TxPDO-Par Standard Ch.2	PDO parameter TxPDO 3	UINT8	RO	0x06 (6 _{dec})
1802:06	Exclude TxPDOs	Specifies the TxPDOs (index of TxPDO mapping objects) that must not be transferred together with TxPDO 3	OCTET-STRING[2]	RO	03 1A

Index 1803 AI TxPDO-Par Compact Ch.1

Index (hex)	Name	Meaning	Data type	Flags	Default
1803:0	AI TxPDO-Par Compact Ch.1	PDO Parameter TxPDO	UINT8	RO	0x06 (6 _{dec})
1803:06	Exclude TxPDOs	Hier sind die TxPDOs (Index der TxPDO Mapping Objekte) angegeben, die nicht zusammen mit TxPDO 2 übertragen werden dürfen	OCTET-STRING[2]	RO	00 1A 02 1A 07 1A 10 1A

Index 1804 AI TxPDO-Par Standard Ch.2

Index (hex)	Name	Meaning	Data type	Flags	Default
1804:0	AI TxPDO-Par Standard Ch.2	PDO Parameter TxPDO	UINT8	RO	0x06 (6 _{dec})
1804:06	Exclude TxPDOs	Hier sind die TxPDOs (Index der TxPDO Mapping Objekte) angegeben, die nicht zusammen mit TxPDO 3 übertragen werden dürfen	OCTET-STRING[2]	RO	00 1A 05 1A 09 1A 10 1A

Index 1805 AI TxPDO-Par Compact Ch.2

Index (hex)	Name	Meaning	Data type	Flags	Default
1805:0	AI TxPDO-Par Compact Ch.2	PDO Parameter TxPDO	UINT8	RO	0x06 (6 _{dec})
1805:06	Exclude TxPDOs	Hier sind die TxPDOs (Index der TxPDO Mapping Objekte) angegeben, die nicht zusammen mit TxPDO 4 übertragen werden dürfen	OCTET-STRING[2]	RO	00 1A 04 1A 09 1A 10 1A

Index 1810 TxPDO-Par Channels

Index (hex)	Name	Meaning	Data type	Flags	Default
1810:0	TxPDO-Par Channels	PDO Parameter TxPDO	UINT8	RO	0x06 (6 _{dec})
1810:06	Exclude TxPDOs	Hier sind die TxPDOs (Index der TxPDO Mapping Objekte) angegeben, die nicht zusammen mit TxPDO 1 übertragen werden dürfen	OCTET-STRING[2]	RO	00 1A 01 1A 02 1A 03 1A 04 1A 05 1A 07 1A 09 1A

Index 1A00 TxPDO-Par Channel 1 (only for EL31x2)

Index (hex)	Name	Meaning	Data type	Flags	Default
1A0n:0	TxPDO Map Ch. 1	PDO Mapping TxPDO Ch. 1	UINT8	RO	0x02 (2 _{dec})
1A00:01	SubIndex 001	1. PDO Mapping entry (object 0x3101 (Inputs), entry 0x01 (Inputs))	UINT32	RO	0x3101:01, 1
1A00:02	SubIndex 002	2. PDO Mapping entry (object 0x3101 (Inputs), entry 0x02 (Inputs))	UINT32	RO	0x3101:02, 1

Index 1A01 TxPDO-Par Channel 2 (only for EL31x2)

Index (hex)	Name	Meaning	Data type	Flags	Default
1A01:0	TxPDO Map Ch. 1	PDO Mapping TxPDO Ch. 1	UINT8	RO	0x02 (2 _{dec})
1A01:01	SubIndex 001	1. PDO Mapping entry (object 0x3102 (Inputs), entry 0x01 (Inputs))	UINT32	RO	0x3102:01, 1
1A01:02	SubIndex 002	2. PDO Mapping entry (object 0x3102 (Inputs), entry 0x02 (Inputs))	UINT32	RO	0x3102:02, 1

Index 1A02 AI TxPDO-Map Standard Ch.1

Index (hex)	Name	Meaning	Data type	Flags	Default
1A02:0	AI TxPDO-Map Standard Ch.1	PDO Mapping TxPDO	UINT8	RO	0x0B (11 _{dec})
1A02:01	SubIndex 001	1. PDO Mapping entry (object 0x6000 (AI Inputs), entry 0x01 (Underrange))	UINT32	RO	0x6000:01, 1
1A02:02	SubIndex 002	2. PDO Mapping entry (object 0x6000 (AI Inputs), entry 0x02 (Overrange))	UINT32	RO	0x6000:02, 1
1A02:03	SubIndex 003	3. PDO Mapping entry (object 0x6000 (AI Inputs), entry 0x03 (Limit 1))	UINT32	RO	0x6000:03, 2
1A02:04	SubIndex 004	4. PDO Mapping entry (object 0x6000 (AI Inputs), entry 0x05 (Limit 2))	UINT32	RO	0x6000:05, 2
1A02:05	SubIndex 005	5. PDO Mapping entry (object 0x6000 (AI Inputs), entry 0x07 (Error))	UINT32	RO	0x6000:07, 1
1A02:06	SubIndex 006	6. PDO Mapping entry (1 bit align)	UINT32	RO	0x0000:00, 1
1A02:07	SubIndex 007	7. PDO Mapping entry (5 bits align)	UINT32	RO	0x0000:00, 5
1A02:08	SubIndex 008	8. PDO Mapping entry (object 0x6000 (AI Inputs), entry 0x0E (Sync Error))	UINT32	RO	0x6000:0E, 1
1A02:09	SubIndex 009	9. PDO Mapping entry (object 0x6000 (AI Inputs), entry 0x0F (TxPDO State))	UINT32	RO	0x6000:0F, 1
1A02:0A	SubIndex 010	10. PDO Mapping entry (object 0x6000 (AI Inputs), entry 0x10 (TxPDO Toggle))	UINT32	RO	0x6000:10, 1
1A02:0B	SubIndex 011	11. PDO Mapping entry (object 0x6000 (AI Inputs), entry 0x11 (Value))	UINT32	RO	0x6000:11, 16

Index 1A03 AI TxPDO-Map Compact Ch.1

Index (hex)	Name	Meaning	Data type	Flags	Default
1A03:0	AI TxPDO-Map Compact Ch.1	PDO Mapping TxPDO	UINT8	RO	0x01 (1 _{dec})
1A03:01	SubIndex 001	1. PDO Mapping entry (object 0x6000 (AI Inputs), entry 0x11 (Value))	UINT32	RO	0x6000:11, 16

Index 1A04 AI TxPDO-Map Standard Ch.2

Index (hex)	Name	Meaning	Data type	Flags	Default
1A04:0	AI TxPDO-Map Standard Ch.2	PDO Mapping TxPDO	UINT8	RO	0x0B (1 _{dec})
1A04:01	SubIndex 001	1. PDO Mapping entry (object 0x6010 (AI Inputs), entry 0x01 (Underrange))	UINT32	RO	0x6010:01, 1
1A04:02	SubIndex 002	2. PDO Mapping entry (object 0x6010 (AI Inputs), entry 0x02 (Overrange))	UINT32	RO	0x6010:02, 1
1A04:03	SubIndex 003	3. PDO Mapping entry (object 0x6010 (AI Inputs), entry 0x03 (Limit 1))	UINT32	RO	0x6010:03, 2
1A04:04	SubIndex 004	4. PDO Mapping entry (object 0x6010 (AI Inputs), entry 0x05 (Limit 2))	UINT32	RO	0x6010:05, 2
1A04:05	SubIndex 005	5. PDO Mapping entry (object 0x6010 (AI Inputs), entry 0x07 (Error))	UINT32	RO	0x6010:07, 1
1A04:06	SubIndex 006	6. PDO Mapping entry (1 bit align)	UINT32	RO	0x0000:00, 1
1A04:07	SubIndex 007	7. PDO Mapping entry (5 bits align)	UINT32	RO	0x0000:00, 5
1A04:08	SubIndex 008	8. PDO Mapping entry (object 0x6010 (AI Inputs), entry 0x0E (Sync Error))	UINT32	RO	0x6010:0E, 1
1A04:09	SubIndex 009	9. PDO Mapping entry (object 0x6010 (AI Inputs), entry 0x0F (TxPDO State))	UINT32	RO	0x6010:0F, 1
1A04:0A	SubIndex 010	10. PDO Mapping entry (object 0x6010 (AI Inputs), entry 0x10 (TxPDO Toggle))	UINT32	RO	0x6010:10, 1
1A04:0B	SubIndex 011	11. PDO Mapping entry (object 0x6010 (AI Inputs), entry 0x11 (Value))	UINT32	RO	0x6010:11, 16

Index 1A05 AI TxPDO-Map Compact Ch.2

Index (hex)	Name	Meaning	Data type	Flags	Default
1A05:0	AI TxPDO-Map Compact Ch.2	PDO Mapping TxPDO	UINT8	RO	0x01 (1 _{dec})
1A05:01	SubIndex 001	1. PDO Mapping entry (object 0x6010 (AI Inputs), entry 0x11 (Value))	UINT32	RO	0x6010:11, 16

Index 1A10 TxPDO-Map Channels

Index (hex)	Name	Meaning	Data type	Flags	Default
1A10:0	TxPDO-Map Channels	PDO Mapping TxPDO	UINT8	RO	0x02 (2 _{dec})
1A10:01	SubIndex 001	1. PDO Mapping entry (object 0x3101 (Inputs), entry 0x01 (Inputs))	UINT32	RO	0x3101:02, 16
1A10:02	SubIndex 002	2. PDO Mapping entry (object 0x3101 (Inputs), entry 0x02 (Inputs))	UINT32	RO	0x3101:02, 16

Index 1C00 Sync manager type

Index (hex)	Name	Meaning	Data type	Flags	Default
1C00:0	Sync manager type	Using the sync managers	UINT8	RO	0x04 (4 _{dec})
1C00:01	SubIndex 001	Sync-Manager Type Channel 1: Mailbox Write	UINT8	RO	0x01 (1 _{dec})
1C00:02	SubIndex 002	Sync-Manager Type Channel 2: Mailbox Read	UINT8	RO	0x02 (2 _{dec})
1C00:03	SubIndex 003	Sync-Manager Type Channel 3: Process Data Write (Outputs)	UINT8	RO	0x03 (3 _{dec})
1C00:04	SubIndex 004	Sync-Manager Type Channel 4: Process Data Read (Inputs)	UINT8	RO	0x04 (4 _{dec})

Index 1C12 RxPDO assign

Index (hex)	Name	Meaning	Data type	Flags	Default
1C12:0	RxPDO assign	PDO Assign Outputs	UINT8	RW	0x00 (0 _{dec})

Index 1C13 TxPDO assign (only for EL31x2 before rev. EL31x2-0000-0016)

For operation on masters other than TwinCAT it must be ensured that the channels are entered in the PDO assignment ("TxPDO assign", object 0x1C13) successively.

Index (hex)	Name	Meaning	Data type	Flags	Default
1C13:0	TxPDO assign	PDO Assign Inputs	UINT8	RW	0x02 (2 _{dec})
1C13:01	SubIndex 001	1. allocated TxPDO (contains the index of the associated TxPDO mapping object)	UINT16	RW	0x1A02
1C13:02	SubIndex 002	2. allocated TxPDO (contains the index of the associated TxPDO mapping object)	UINT16	RW	0x1A04

Index 1C13 TxPDO assign (only for EL31x2 from rev. EL31x2-0000-0016)

For operation on masters other than TwinCAT it must be ensured that the channels are entered in the PDO assignment ("TxPDO assign", object 0x1C13) successively.

Index (hex)	Name	Meaning	Data type	Flags	Default
1C13:0	TxPDO assign	PDO Assign Inputs	UINT8	RW	0x02 (2 _{dec})
1C13:01	SubIndex 001	1. allocated TxPDO (contains the index of the associated TxPDO mapping object)	UINT16	RW	0x1A00
1C13:02	SubIndex 002	2. allocated TxPDO (contains the index of the associated TxPDO mapping object)	UINT16	RW	0x1A01

Index 1C33*** SM input parameter

Index (hex)	Name	Meaning	Data type	Flags	Default
1C33:0	SM input parameter	Synchronization parameters for the inputs	UINT8	RO	0x20 (32 _{dec})
1C33:01	Sync mode	Current synchronization mode: <ul style="list-style-type: none"> • Bit 0 = 0: Free Run • Bit 0 = 1: Synchronous with SM 3 event • Bit 0-1 = 11: DC with SYNC1 event • Bit 15 = 1: Fast mode 	UINT16	RW	0x0022 (34 _{dec})
1C33:02	Cycle time	Cycle time (in ns): <ul style="list-style-type: none"> • Free Run: Cycle time of the local timer • Synchronous with SM 2 event: Master cycle time • DC mode: SYNC0/SYNC1 Cycle Time 	UINT32	RW	0x000F4240 (1000000 _{dec})
1C33:03	Shift time	Time between SYNC0 event and reading of the inputs (in ns, only DC mode)	UINT32	RO	0x000186A0 (100000 _{dec})
1C33:04	Sync modes supported	Supported synchronization modes: <ul style="list-style-type: none"> • Bit 0 = 1: Free Run is supported • Bit 1: Synchron with SM 3 Event is supported (no Outputs available) • Bit 2 = 1: DC mode (SYNC0) • Bit 3 = 1: DC mode (SYNC1) • Bit 4-5 = 01: Input Shift with local event (Outputs available) • Bit 4-5 = 10: Input Shift with SYNC1 Event (no Outputs available) • Bit 12 = 1: Legacy Synchron • Bit 13 = 1: SM event • Bit 14 = 1: dynamic times (measure by writing 1C33:08 [▶ 418]) • Bit 15 = 1: Fast mode 	UINT16	RO	0xD00B (53259 _{dec})
1C33:05	Minimum cycle time	Minimum cycle time (in ns)	UINT32	RO	0x000186A0 (100000 _{dec})
1C33:06	Calc and copy time	Time between reading of the inputs and availability of the inputs for the master (in ns, only DC mode)	UINT32	RO	0x00002710 (10000dez)
1C33:08	Command	With this entry the real required process data provision time can be measured. <ul style="list-style-type: none"> • 0: Measurement of the local cycle time is stopped • 1: Measurement of the local cycle time is started <p>The entries 1C33:03 [▶ 418], 1C33:06 [▶ 418], and 1C33:09 [▶ 418] are updated with the maximum measured values. For a subsequent measurement the measured values are reset</p>	UINT16	RW	0x0000 (0 _{dec})
1C33:09	Maximum Delay time	Time between SYNC1 event and reading of the inputs (in ns, only DC mode)	UINT32	RO	0x000186A0 (100000dez)
1C33:0B	SM event missed counter	Number of missed SM events in OPERATIONAL (DC mode only)	UINT16	RO	0x0000 (0 _{dec})
1C33:0C	Cycle exceeded counter	Number of occasions the cycle time was exceeded in OPERATIONAL (cycle was not completed in time or the next cycle began too early)	UINT16	RO	0x0000 (0 _{dec})
1C33:0D	Shift too short counter	Number of occasions that the interval between SYNC0 and SYNC1 event was too short (DC mode only)	UINT16	RO	0x0000 (0 _{dec})
1C33:20	Sync error	The synchronization was not correct in the last cycle (outputs were output too late; DC mode only)	BOOLEAN	RO	0x00 (0 _{dec})

***) since revision no. EL31xx-00xx-0016

Index F009*** Password protection

Index (hex)	Name	Meaning	Data type	Flags	Default
F009:0	Password protection	Password protection user calibration [▶ 259]	UINT32	RW	0x00000000 (0 _{dec})

***) for EL31xx, see [note \[▶ 259\]](#)

5.6.5.3 EL3154

5.6.5.3.1 Restore object

Index 1011 Restore default parameters

Index (hex)	Name	Meaning	Data type	Flags	Default
1011:0	Restore default parameters [▶ 503]	Restore default parameters	UINT8	RO	0x01 (1 _{dec})
1011:01	SubIndex 001	If this object is set to “0x64616F6C” in the set value dialog, all backup objects are reset to their delivery state.	UINT32	RW	0x00000000 (0 _{dec})

5.6.5.3.2 Configuration data

Index 80n0*** AI settings (for 0 ≤ n ≤ 3)

Index (hex)	Name	Meaning	Data type	Flags	Default
80n0:0	AI Settings	Maximum subindex	UINT8	RO	0x18 (24 _{dec})
80n0:01	Enable user scale [▶ 269]	User scale is active.	BOOLEAN	RW	0x00 (0 _{dec})
80n0:02	Presentation [▶ 244]	0: Signed presentation 1: Unsigned presentation 2: Absolute value with MSB as sign Signed amount representation	BIT3	RW	0x00 (0 _{dec})
80n0:05	Siemens bits [▶ 246]	The S5 bits are displayed in the three low-order bits	BOOLEAN	RW	0x00 (0 _{dec})
80n0:06	Enable filter	Enable filter, which makes PLC-cycle-synchronous data exchange unnecessary	BOOLEAN	RW	0x00 (0 _{dec})
80n0:07	Enable limit 1 [▶ 246]	Limit 1 enabled	BOOLEAN	RW	0x00 (0 _{dec})
80n0:08	Enable limit 2 [▶ 246]	Limit 2 enabled	BOOLEAN	RW	0x00 (0 _{dec})
80n0:0A	Enable user calibration [▶ 269]	Enabling of the user calibration	BOOLEAN	RW	0x00 (0 _{dec})
80n0:0B	Enable vendor calibration [▶ 269]	Enabling of the vendor calibration	BOOLEAN	RW	0x01 (1 _{dec})
80n0:0E	Swap limit bits [▶ 247]	Changing of the Limit Bits	BOOLEAN	RW	0x00 (0 _{dec})
80n0:11	User scale offset [▶ 269]	User scaling offset	INT16	RW	0x0000 (0 _{dec})
80n0:12	User scale gain [▶ 269]	User scaling gain. The gain is represented in fixed-point format, with the factor 2 ⁻¹⁶ . The value 1 corresponds to 65536 _{dec} (0x00010000) and is limited to ±0x7FFFF	INT32	RW	0x00010000 (65536 _{dec})
80n0:13	Limit 1 [▶ 246]	First limit value for setting the status bits	INT16	RW	0x0000 (0 _{dec})
80n0:14	Limit 2 [▶ 246]	Second limit value for setting the status bits	INT16	RW	0x0000 (0 _{dec})
80n0:15	Filter settings	This object determines the digital filter settings, if it is active via Enable filter (index 0x80n0:06 [▶ 420]). The possible settings are sequentially numbered. 0: 50 Hz FIR 1: 60 Hz FIR 2: IIR 1 3: IIR 2 4: IIR 3 5: IIR 4 6: IIR 5 7: IIR 6 8: IIR 7 9: IIR 8	UINT16	RW	0x0000 (0 _{dec})
80n0:17	User calibration offset [▶ 269]	User offset compensation	INT16	RW	0x0000 (0 _{dec})
80n0:18	User calibration gain [▶ 269]	User calibration gain	INT16	RW	0x4000 (16384 _{dec})

***) since revision no. EL31xx-00xx-0016

Filter

The filters of the EL30xx/EL31xx are activated or deactivated via the CoE index 0x8000:15.



The filter characteristics are set via index 0x8000:15

The filter frequencies are set for all channels of the EL30xx/EL31xx terminals centrally via index 0x8000:15 (channel 1). All other corresponding indices 0x80n0:15 have no parameterization function! The latest firmware version (see [status table](#) [▶ 484]) returns an EtherCAT-compliant error message, if the filter characteristics of other channels (index 0x80n0:06, 0x80n0:15) are set.

5.6.5.3.3 Profile-specific objects (0x6000-0xFFFF)

The profile-specific objects have the same meaning for all EtherCAT slaves that support the profile 5001.

5.6.5.3.3.1 Input data

Index 60n0* AI inputs (for 0 ≤ n ≤ 3)**

Index (hex)	Name	Meaning	Data type	Flags	Default
60n0:0	AI inputs	Maximum subindex	INT16	RO	0x11 (17 _{dec})
60n0:01	Underrange	Value below measuring range.	BOOLEAN	RO	0x00 (0 _{dec})
60n0:02	Ovrange	Measuring range exceeded.	BOOLEAN	RO	0x00 (0 _{dec})
60n0:03	Limit 1	Limit value monitoring Limit 1 0: not active 1: value is smaller than limit value 1 2: value is larger than limit value 1 3: Value is equal to limit value 1	BIT2	RO	0x00 (0 _{dec})
60n0:05	Limit 2	Limit value monitoring limit 2 0: not active 1: value is smaller than limit value 2 2: value is larger than limit value 2 3: Value is equal to limit value 2	BIT2	RO	0x00 (0 _{dec})
60n0:07	Error	The error bit is set if the data is invalid (over-range, under-range)	BOOLEAN	RO	0x00 (0 _{dec})
60n0:0E	Sync error	The Sync error bit is only required for DC mode. It indicates whether a synchronization error has occurred during the previous cycle. This means a SYNC signal was triggered in the EL31xx, although no new process data were available (0=OK, 1=NOK).	BOOLEAN	RO	0x00 (0 _{dec})
60n0:0F	TxPDO State	Validity of the data of the associated TxPDO (0 = valid, 1 = invalid).	BOOLEAN	RO	0x00 (0 _{dec})
60n0:10	TxPDO Toggle	The TxPDO toggle is toggled by the slave when the data of the associated TxPDO is updated.	BOOLEAN	RO	0x00 (0 _{dec})
60n0:11	Value	Analog input date	INT16	RO	0x0000 (0 _{dec})

***) since revision no. EL31xx-00xx-0016

5.6.5.3.3.2 Configuration data (vendor-specific)

Index 80nF* AI vendor data (for 0 ≤ n ≤ 3)**

Index (hex)	Name	Meaning	Data type	Flags	Default
80nF:0	AI vendor data	Maximum subindex	UINT8	RO	0x02 (2 _{dec})
80nF:01	Calibration offset	Offset (vendor calibration)	INT16	RW	0x0000 (0 _{dec})
80nF:02	Calibration gain	Gain (vendor calibration)	INT16	RW	0x4000 (16384 _{dec})

***) since revision no. EL31xx-00xx-0016

5.6.5.3.3 Information and diagnostic data

Index 80nE*** AI internal data (for $0 \leq n \leq 3$)

Index (hex)	Name	Meaning	Data type	Flags	Default
80nE:0	AI internal data	Maximum subindex	UINT8	RO	0x01 (1 _{dec})
80nE:01	ADC raw value	ADC raw value	UINT16	RO	-

***) since revision no. EL31xx-00xx-0016

Index F000*** Modular device profile

Index (hex)	Name	Meaning	Data type	Flags	Default
F000:0	Modular device profile	General information for the modular device profile	UINT8	RO	0x02 (2 _{dec})
F000:01	Module index distance	Index spacing of the objects of the individual channels	UINT16	RO	0x0010 (16 _{dec})
F000:02	Maximum number of modules	Number of channels	UINT16	RO	Max. Channels number of the terminal

***) since revision no. EL31xx-00xx-0016

Index F008*** Code word

Index	Name	Meaning	Data type	Flags	Default
F008:0	Code word	reserved	UINT32	RW	0x00000000 (0 _{dec})

***) since revision no. EL31xx-00xx-0016

Index F010*** module list (for $1 \leq n \leq 4$, depends on number of channels)

Index (hex)	Name	Meaning	Data type	Flags	Default
F010:0	Module list	Maximum subindex	UINT8	RW	0x0n
F010:0n	SubIndex 00n	Analog input profile (300)	UINT32	RW	0x0000012C (300 _{dec})

***) since revision no. EL31xx-00xx-0016

5.6.5.3.4 Standard objects

Standard objects (0x1000-0x1FFF)

The standard objects have the same meaning for all EtherCAT slaves.

Index 1000 Device type

Index (hex)	Name	Meaning	Data type	Flags	Default
1000:0	Device type	Device type of the EtherCAT slave: the Lo-Word contains the CoE profile used (5001). The Hi-Word contains the module profile according to the modular device profile.	UINT32	RO	0x012C1389 (19665801 _{dec})

Index 1008 Device name

Index (hex)	Name	Meaning	Data type	Flags	Default
1008:0	Device name	Device name of the EtherCAT slave	STRING	RO	EL31xx

Index 1009 Hardware version

Index (hex)	Name	Meaning	Data type	Flags	Default
1009:0	Hardware version	Hardware version of the EtherCAT slave	STRING	RO	00

Index 100A Software version

Index (hex)	Name	Meaning	Data type	Flags	Default
100A:0	Software version	Firmware version of the EtherCAT slave	STRING	RO	-

Index 1018 Identity

Index (hex)	Name	Meaning	Data type	Flags	Default
1018:0	Identity	Information for identifying the slave	UINT8	RO	0x04 (4 _{dec})
1018:01	Vendor ID	Vendor ID of the EtherCAT slave	UINT32	RO	0x00000002 (2 _{dec})
1018:02	Product code	Product code of the EtherCAT slave	UINT32	RO	0xFFFF3052
1018:03	Revision	Revision number of the EtherCAT slave; the low word (bit 0-15) indicates the special terminal number, the high word (bit 16-31) refers to the device description	UINT32	RO	-
1018:04	Serial number	Serial number of the EtherCAT slave; the low byte (bit 0-7) of the low word contains the year of production, the high byte (bit 8-15) of the low word contains the week of production, the high word (bit 16-31) is 0	UINT32	RO	-

Index 10F0* Backup parameter handling**

Index (hex)	Name	Meaning	Data type	Flags	Default
10F0:0	Backup parameter handling	Information for standardized loading and saving of backup entries	UINT8	RO	0x01 (1 _{dec})
10F0:01	Checksum	Checksum across all backup entries of the EtherCAT slave	UINT32	RO	-

***) since revision no. EL31xx-00xx-0016

Index 1800 AI TxPDO-Par Standard Ch.1

Index (hex)	Name	Meaning	Data type	Flags	Default
1800:0	AI TxPDO-Par Standard Ch.1	PDO parameter TxPDO 1	UINT8	RO	0x06 (6 _{dec})
1800:06	Exclude TxPDOs	Specifies the TxPDOs (index of TxPDO mapping objects) that must not be transferred together with TxPDO 1	OCTET-STRING[2]	RO	01 1A

Index 1801 AI TxPDO-Par Compact Ch.1

Index (hex)	Name	Meaning	Data type	Flags	Default
1801:0	AI TxPDO-Par Compact Ch.1	PDO parameter TxPDO 2	UINT8	RO	0x06 (6 _{dec})
1801:06	Exclude TxPDOs	Specifies the TxPDOs (index of TxPDO mapping objects) that must not be transferred together with TxPDO 2	OCTET-STRING[2]	RO	00 1A

Index 1802 AI TxPDO-Par Standard Ch.2

Index (hex)	Name	Meaning	Data type	Flags	Default
1802:0	AI TxPDO-Par Standard Ch.2	PDO parameter TxPDO 3	UINT8	RO	0x06 (6 _{dec})
1802:06	Exclude TxPDOs	Specifies the TxPDOs (index of TxPDO mapping objects) that must not be transferred together with TxPDO 3	OCTET-STRING[2]	RO	03 1A

Index 1803 AI TxPDO-Par Compact Ch. 2

Index (hex)	Name	Meaning	Data type	Flags	Default
1803:0	AI TxPDO-Par Compact Ch.2	PDO parameter TxPDO 4	UINT8	RO	0x06 (6 _{dec})
1803:06	Exclude TxPDOs	Specifies the TxPDOs (index of TxPDO mapping objects) that must not be transferred together with TxPDO 4	OCTET-STRING[2]	RO	02 1A

Index 1804 AI TxPDO-Par Standard Ch.3

Index (hex)	Name	Meaning	Data type	Flags	Default
1804:0	AI TxPDO-Par Standard Ch.3	PDO parameter TxPDO 5	UINT8	RO	0x06 (6 _{dec})
1804:06	Exclude TxPDOs	Specifies the TxPDOs (index of TxPDO mapping objects) that must not be transferred together with TxPDO 5	OCTET-STRING[2]	RO	05 1A

Index 1805 AI TxPDO-Par Compact Ch. 3

Index (hex)	Name	Meaning	Data type	Flags	Default
1805:0	AI TxPDO-Par Compact Ch.3	PDO parameter TxPDO 6	UINT8	RO	0x06 (6 _{dec})
1805:06	Exclude TxPDOs	Specifies the TxPDOs (index of TxPDO mapping objects) that must not be transferred together with TxPDO 6	OCTET-STRING[2]	RO	04 1A

Index 1806 AI TxPDO-Par Standard Ch.4

Index (hex)	Name	Meaning	Data type	Flags	Default
1806:0	AI TxPDO-Par Standard Ch.4	PDO parameter TxPDO 7	UINT8	RO	0x06 (6 _{dec})
1806:06	Exclude TxPDOs	Specifies the TxPDOs (index of TxPDO mapping objects) that must not be transferred together with TxPDO 7	OCTET-STRING[2]	RO	07 1A

Index 1807 AI TxPDO-Par Compact Ch. 4

Index (hex)	Name	Meaning	Data type	Flags	Default
1807:0	AI TxPDO-Par Compact Ch.4	PDO parameter TxPDO 8	UINT8	RO	0x06 (6 _{dec})
1807:06	Exclude TxPDOs	Specifies the TxPDOs (index of TxPDO mapping objects) that must not be transferred together with TxPDO 8	OCTET-STRING[2]	RO	06 1A

Index 1A00 AI TxPDO-Map Standard Ch.1

Index (hex)	Name	Meaning	Data type	Flags	Default
1A00:0	AI TxPDO-Map Standard Ch.1	PDO Mapping TxPDO	UINT8	RO	0x0B (11 _{dec})
1A00:01	SubIndex 001	1. PDO Mapping entry (object 0x6000 (AI Inputs), entry 0x01 (Underrange))	UINT32	RO	0x6000:01, 1
1A00:02	SubIndex 002	2. PDO Mapping entry (object 0x6000 (AI Inputs), entry 0x02 (Ovrrange))	UINT32	RO	0x6000:02, 1
1A00:03	SubIndex 003	3. PDO Mapping entry (object 0x6000 (AI Inputs), entry 0x03 (Limit 1))	UINT32	RO	0x6000:03, 2
1A00:04	SubIndex 004	4. PDO Mapping entry (object 0x6000 (AI Inputs), entry 0x05 (Limit 2))	UINT32	RO	0x6000:05, 2
1A00:05	SubIndex 005	5. PDO Mapping entry (object 0x6000 (AI Inputs), entry 0x07 (Error))	UINT32	RO	0x6000:07, 1
1A00:06	SubIndex 006	6. PDO Mapping entry (1 bit align)	UINT32	RO	0x0000:00, 1
1A00:07	SubIndex 007	7. PDO Mapping entry (5 bits align)	UINT32	RO	0x0000:00, 5
1A00:08	SubIndex 008	8. PDO Mapping entry (object 0x6000 (AI Inputs), entry 0x0E (Sync Error))	UINT32	RO	0x6000:0E, 1
1A00:09	SubIndex 009	9. PDO Mapping entry (object 0x6000 (AI Inputs), entry 0x0F (TxPDO State))	UINT32	RO	0x6000:0F, 1
1A00:0A	SubIndex 010	10. PDO Mapping entry (object 0x6000 (AI Inputs), entry 0x10 (TxPDO Toggle))	UINT32	RO	0x6000:10, 1
1A00:0B	SubIndex 011	11. PDO Mapping entry (object 0x6000 (AI Inputs), entry 0x11 (Value))	UINT32	RO	0x6000:11, 16

Index 1A01 AI TxPDO-Map Compact Ch.1

Index (hex)	Name	Meaning	Data type	Flags	Default
1A01:0	AI TxPDO-Map Compact Ch.1	PDO Mapping TxPDO 2	UINT8	RO	0x01 (1 _{dec})
1A01:01	SubIndex 001	1. PDO Mapping entry (object 0x6000 (AI Inputs), entry 0x11 (Value))	UINT32	RO	0x6000:11, 16

Index 1A02 AI TxPDO-Map Standard Ch.

Index (hex)	Name	Meaning	Data type	Flags	Default
1A02:0	AI TxPDO-Map Standard Ch.2	PDO Mapping TxPDO	UINT8	RO	0x0B (11 _{dec})
1A02:01	SubIndex 001	1. PDO Mapping entry (object 0x6010 (AI Inputs), entry 0x01 (Underrange))	UINT32	RO	0x6010:01, 1
1A02:02	SubIndex 002	2. PDO Mapping entry (object 0x6010 (AI Inputs), entry 0x02 (Overrange))	UINT32	RO	0x6010:02, 1
1A02:03	SubIndex 003	3. PDO Mapping entry (object 0x6010 (AI Inputs), entry 0x03 (Limit 1))	UINT32	RO	0x6010:03, 2
1A02:04	SubIndex 004	4. PDO Mapping entry (object 0x6010 (AI Inputs), entry 0x05 (Limit 2))	UINT32	RO	0x6010:05, 2
1A02:05	SubIndex 005	5. PDO Mapping entry (object 0x6010 (AI Inputs), entry 0x07 (Error))	UINT32	RO	0x6010:07, 1
1A02:06	SubIndex 006	6. PDO Mapping entry (1 bit align)	UINT32	RO	0x0000:00, 1
1A02:07	SubIndex 007	7. PDO Mapping entry (5 bits align)	UINT32	RO	0x0000:00, 5
1A02:08	SubIndex 008	8. PDO Mapping entry (object 0x6010 (AI Inputs), entry 0x0E (Sync Error))	UINT32	RO	0x6010:0E, 1
1A02:09	SubIndex 009	9. PDO Mapping entry (object 0x6010 (AI Inputs), entry 0x0F (TxPDO State))	UINT32	RO	0x6010:0F, 1
1A02:0A	SubIndex 010	10. PDO Mapping entry (object 0x6010 (AI Inputs), entry 0x10 (TxPDO Toggle))	UINT32	RO	0x6010:10, 1
1A02:0B	SubIndex 011	11. PDO Mapping entry (object 0x6010 (AI Inputs), entry 0x11 (Value))	UINT32	RO	0x6010:11, 16

Index 1A03 AI TxPDO-Map Compact Ch.2

Index (hex)	Name	Meaning	Data type	Flags	Default
1A03:0	AI TxPDO-Map Compact Ch.2	PDO Mapping TxPDO 4	UINT8	RO	0x01 (1 _{dec})
1A03:01	SubIndex 001	1. PDO Mapping entry (object 0x6010 (AI Inputs), entry 0x11 (Value))	UINT32	RO	0x6010:11, 16

Index 1A04 AI TxPDO-Map Standard Ch.3

Index (hex)	Name	Meaning	Data type	Flags	Default
1A04:0	AI TxPDO-Map Standard Ch.3	PDO Mapping TxPDO	UINT8	RO	0x0B (11 _{dec})
1A04:01	SubIndex 001	1. PDO Mapping entry (object 0x6020 (AI Inputs), entry 0x01 (Underrange))	UINT32	RO	0x6020:01, 1
1A04:02	SubIndex 002	2. PDO Mapping entry (object 0x6020 (AI Inputs), entry 0x02 (Overrange))	UINT32	RO	0x6020:02, 1
1A04:03	SubIndex 003	3. PDO Mapping entry (object 0x6020 (AI Inputs), entry 0x03 (Limit 1))	UINT32	RO	0x6020:03, 2
1A04:04	SubIndex 004	4. PDO Mapping entry (object 0x6020 (AI Inputs), entry 0x05 (Limit 2))	UINT32	RO	0x6020:05, 2
1A04:05	SubIndex 005	5. PDO Mapping entry (object 0x6020 (AI Inputs), entry 0x07 (Error))	UINT32	RO	0x6020:07, 1
1A04:06	SubIndex 006	6. PDO Mapping entry (1 bit align)	UINT32	RO	0x0000:00, 1
1A04:07	SubIndex 007	7. PDO Mapping entry (5 bits align)	UINT32	RO	0x0000:00, 5
1A04:08	SubIndex 008	8. PDO Mapping entry (object 0x6020 (AI Inputs), entry 0x0E (Sync Error))	UINT32	RO	0x6020:0E, 1
1A04:09	SubIndex 009	9. PDO Mapping entry (object 0x6020 (AI Inputs), entry 0x0F (TxPDO State))	UINT32	RO	0x6020:0F, 1
1A04:0A	SubIndex 010	10. PDO Mapping entry (object 0x6020 (AI Inputs), entry 0x10 (TxPDO Toggle))	UINT32	RO	0x6020:10, 1
1A04:0B	SubIndex 011	11. PDO Mapping entry (object 0x6020 (AI Inputs), entry 0x11 (Value))	UINT32	RO	0x6020:11, 16

Index 1A05 AI TxPDO-Map Compact Ch.3

Index (hex)	Name	Meaning	Data type	Flags	Default
1A05:0	AI TxPDO-Map Compact Ch.3	PDO Mapping TxPDO 6	UINT8	RO	0x01 (1 _{dec})
1A05:01	SubIndex 001	1. PDO Mapping entry (object 0x6020 (AI Inputs), entry 0x11 (Value))	UINT32	RO	0x6020:11, 16

Index 1A06 AI TxPDO-Map Standard Ch.4

Index (hex)	Name	Meaning	Data type	Flags	Default
1A06:0	AI TxPDO-Map Standard Ch.4	PDO Mapping TxPDO	UINT8	RO	0x0B (11 _{dec})
1A06:01	SubIndex 001	1. PDO Mapping entry (object 0x6030 (AI Inputs), entry 0x01 (Underrange))	UINT32	RO	0x6030:01, 1
1A06:02	SubIndex 002	2. PDO Mapping entry (object 0x6030 (AI Inputs), entry 0x02 (Overrange))	UINT32	RO	0x6030:02, 1
1A06:03	SubIndex 003	3. PDO Mapping entry (object 0x6030 (AI Inputs), entry 0x03 (Limit 1))	UINT32	RO	0x6030:03, 2
1A06:04	SubIndex 004	4. PDO Mapping entry (object 0x6030 (AI Inputs), entry 0x05 (Limit 2))	UINT32	RO	0x6030:05, 2
1A06:05	SubIndex 005	5. PDO Mapping entry (object 0x6030 (AI Inputs), entry 0x07 (Error))	UINT32	RO	0x6030:07, 1
1A06:06	SubIndex 006	6. PDO Mapping entry (1 bit align)	UINT32	RO	0x0000:00, 1
1A06:07	SubIndex 007	7. PDO Mapping entry (5 bits align)	UINT32	RO	0x0000:00, 5
1A06:08	SubIndex 008	8. PDO Mapping entry (object 0x6030 (AI Inputs), entry 0x0E (Sync Error))	UINT32	RO	0x6030:0E, 1
1A06:09	SubIndex 009	9. PDO Mapping entry (object 0x6030 (AI Inputs), entry 0x0F (TxPDO State))	UINT32	RO	0x6030:0F, 1
1A06:0A	SubIndex 010	10. PDO Mapping entry (object 0x6030 (AI Inputs), entry 0x10 (TxPDO Toggle))	UINT32	RO	0x6030:10, 1
1A06:0B	SubIndex 011	11. PDO Mapping entry (object 0x6030 (AI Inputs), entry 0x11 (Value))	UINT32	RO	0x6030:11, 16

Index 1A07 AI TxPDO-Map Compact Ch.4

Index (hex)	Name	Meaning	Data type	Flags	Default
1A07:0	AI TxPDO-Map Compact Ch.4	PDO Mapping TxPDO 8	UINT8	RO	0x01 (1 _{dec})
1A07:01	SubIndex 001	1. PDO Mapping entry (object 0x6030 (AI Inputs), entry 0x11 (Value))	UINT32	RO	0x6030:11, 16

Index 1C00 Sync manager type

Index (hex)	Name	Meaning	Data type	Flags	Default
1C00:0	Sync manager type	Using the sync managers	UINT8	RO	0x04 (4 _{dec})
1C00:01	SubIndex 001	Sync-Manager Type Channel 1: Mailbox Write	UINT8	RO	0x01 (1 _{dec})
1C00:02	SubIndex 002	Sync-Manager Type Channel 2: Mailbox Read	UINT8	RO	0x02 (2 _{dec})
1C00:03	SubIndex 003	Sync-Manager Type Channel 3: Process Data Write (Outputs)	UINT8	RO	0x03 (3 _{dec})
1C00:04	SubIndex 004	Sync-Manager Type Channel 4: Process Data Read (Inputs)	UINT8	RO	0x04 (4 _{dec})

Index 1C12 RxPDO assign

Index (hex)	Name	Meaning	Data type	Flags	Default
1C12:0	RxPDO assign	PDO Assign Outputs	UINT8	RW	0x00 (0 _{dec})

Index 1C13 TxPDO assign

For operation on masters other than TwinCAT it must be ensured that the channels are entered in the PDO assignment ("TxPDO assign", object 0x1C13) successively.

Index (hex)	Name	Meaning	Data type	Flags	Default
1C13:0	TxPDO assign	PDO Assign Inputs	UINT8	RW	0x04 (4 _{dec})
1C13:01	SubIndex 001	1. zugeordnete TxPDO (enthält den Index des zugehörigen TxPDO Mapping Objekts)	UINT16	RW	0x1A00 (6656 _{dec})
1C13:02	SubIndex 002	2. zugeordnete TxPDO (enthält den Index des zugehörigen TxPDO Mapping Objekts)	UINT16	RW	0x1A02 (6658 _{dec})
1C13:03	SubIndex 003	3. zugeordnete TxPDO (enthält den Index des zugehörigen TxPDO Mapping Objekts)	UINT16	RW	0x1A04 (6660 _{dec})
1C13:04	SubIndex 004	4. zugeordnete TxPDO (enthält den Index des zugehörigen TxPDO Mapping Objekts)	UINT16	RW	0x1A06 (6662 _{dec})

Index 1C33 SM input parameter

Index (hex)	Name	Meaning	Data type	Flags	Default
1C33:0	SM input parameter	Synchronization parameters for the inputs	UINT8	RO	0x20 (32 _{dec})
1C33:01	Sync mode	Current synchronization mode: <ul style="list-style-type: none"> Bit 0 = 0: Free Run Bit 0 = 1: Synchron with SM 2 Event Bit 15 = 0: Standard Bit 15 = 1: FastOp mode (CoE deactivated) 	UINT16	RW	0x0000 (0 _{dec})
1C33:02	Cycle time	Cycle time (in ns): <ul style="list-style-type: none"> Free Run: Cycle time of the local timer Synchronous with SM 2 event: Master cycle time DC-Mode: SYNC0/SYNC1 Cycle Time 	UINT32	RW	0x000F4240 (1000000 _{dec})
1C33:03	Shift time	Time between SYNC0 event and reading of the inputs (in ns, only DC mode)	UINT32	RO	0x00000000 (0 _{dec})
1C33:04	Sync modes supported	Supported synchronization modes: <ul style="list-style-type: none"> Bit 0: free run is supported Bit 1: synchronous with SM 2 event is supported (outputs available) Bit 1: synchronous with SM 3 event is supported (no outputs available) Bit 2-3 = 01: DC mode is supported Bit 4-5 = 01: input shift through local event (outputs available) Bit 4-5 = 10: input shift with SYNC1 event (no outputs available) Bit 14 = 1: dynamic times (measurement through writing of 0x1C33:08) 	UINT16	RO	0xC003 (49155 _{dec})
1C33:05	Minimum cycle time	Minimum cycle time (in ns)	UINT32	RO	0x0000FDE8 (65000 _{dec})
1C33:06	Calc and copy time	Time between reading of the inputs and availability of the inputs for the master (in ns, only DC mode)	UINT32	RO	0x00000000 (0 _{dec})
1C33:07	Minimum delay time		UINT32	RO	0x00000000 (0 _{dec})
1C33:08	Get cycle time	With this entry the real required process data provision time can be measured. <ul style="list-style-type: none"> 0: Measurement of the local cycle time is stopped 1: Measurement of the local cycle time is started The entries 0x1C33:03, 0x1C33:06, 1C33:09 are updated with the maximum measured values. For a subsequent measurement the measured values are reset.	UINT16	RW	0x0000 (0 _{dec})
1C33:09	Maximum delay time	Time between SYNC1 event and reading of the inputs (in ns, only DC mode)	UINT32	RO	0x00000000 (0 _{dec})
1C33:0B	SM event missed counter	Number of missed SM events in OPERATIONAL (DC mode only)	UINT16	RO	0x0000 (0 _{dec})
1C33:0C	Cycle exceeded counter	Number of occasions the cycle time was exceeded in OPERATIONAL (cycle was not completed in time or the next cycle began too early)	UINT16	RO	0x0000 (0 _{dec})
1C33:0D	Shift too short counter	Number of occasions that the interval between SYNC0 and SYNC1 event was too short (DC mode only)	UINT16	RO	0x0000 (0 _{dec})
1C33:20	Sync error	The synchronization was not correct in the last cycle (outputs were output too late; DC mode only)	BOOLEAN	RO	0x00 (0 _{dec})

Index F009*** Password protection

Index (hex)	Name	Meaning	Data type	Flags	Default
F009:0	Password protection	Password protection user calibration [► 259]	UINT32	RW	0x00000000 (0 _{dec})

***) for EL31xx, see [note](#) [► 259]

5.6.6 EL316x

5.6.6.1 EL3161

5.6.6.1.1 Restore object

Index 1011 Restore default parameters

Index (hex)	Name	Meaning	Data type	Flags	Default
1011:0	Restore default parameters [▶ 503]	Restore default parameters	UINT8	RO	0x01 (1 _{dec})
1011:01	SubIndex 001	If this object is set to “0x64616F6C” in the set value dialog, all backup objects are reset to their delivery state.	UINT32	RW	0x00000000 (0 _{dec})

5.6.6.1.2 Configuration data

Index 8000 AI settings

Index (hex)	Name	Meaning	Data type	Flags	Default
8000:0	AI Settings	Maximum subindex	UINT8	RO	0x18 (24 _{dec})
8000:01	Enable user scale [▶ 269]	User scale is active.	BOOLEAN	RW	0x00 (0 _{dec})
8000:02	Presentation [▶ 244]	0: Signed presentation 1: Unsigned presentation 2: Absolute value with MSB as sign Signed amount representation	BIT3	RW	0x00 (0 _{dec})
8000:05	Siemens bits [▶ 246]	The S5 bits are displayed in the three low-order bits	BOOLEAN	RW	0x00 (0 _{dec})
8000:06	Enable filter	Enable filter, which makes PLC-cycle-synchronous data exchange unnecessary	BOOLEAN	RW	0x00 (0 _{dec})
8000:07	Enable limit 1 [▶ 246]	Limit 1 enabled	BOOLEAN	RW	0x00 (0 _{dec})
8000:08	Enable limit 2 [▶ 246]	Limit 2 enabled	BOOLEAN	RW	0x00 (0 _{dec})
8000:0A	Enable user calibration [▶ 269]	Enabling of the user calibration	BOOLEAN	RW	0x00 (0 _{dec})
8000:0B	Enable vendor calibration [▶ 269]	Enabling of the vendor calibration	BOOLEAN	RW	0x01 (1 _{dec})
8000:0E	Swap limit bits [▶ 247]	Changing of the Limit Bits	BOOLEAN	RW	0x00 (0 _{dec})
80n0:11	User scale offset [▶ 269]	User scaling offset	INT16	RW	0x0000 (0 _{dec})
80n0:12	User scale gain [▶ 269]	User scaling gain. The gain is represented in fixed-point format, with the factor 2 ⁻¹⁶ . The value 1 corresponds to 65536 _{dec} (0x00010000) and is limited to ±0x7FFFF	INT32	RW	0x00010000 (65536 _{dec})
80n0:13	Limit 1 [▶ 246]	First limit value for setting the status bits	INT16	RW	0x0000 (0 _{dec})
80n0:14	Limit 2 [▶ 246]	Second limit value for setting the status bits	INT16	RW	0x0000 (0 _{dec})
80n0:15	Filter settings	This object determines the digital filter settings, if it is active via Enable filter (index 0x8000:06 [▶ 430]). The possible settings are sequentially numbered. 0: 50 Hz FIR 1: 60 Hz FIR 2: IIR 1 3: IIR 2 4: IIR 3 5: IIR 4 6: IIR 5 7: IIR 6 8: IIR 7 9: IIR 8	UINT16	RW	0x0000 (0 _{dec})
80n0:17	User calibration offset [▶ 269]	User offset compensation	INT16	RW	0x0000 (0 _{dec})
80n0:18	User calibration gain [▶ 269]	User calibration gain	INT16	RW	0x4000 (16384 _{dec})

***) since revision no. EL31xx-00xx-0016



The filter characteristics are set via index [0x8000:15](#) [\[▶ 430\]](#)

The filter frequencies are set for all channels of the EL31xx terminals centrally via index [0x8000:15](#) [\[▶ 430\]](#) (channel 1). All other corresponding indices 0x80n0:15 have no parameterization function!

5.6.6.1.3 Profile-specific objects (0x6000-0xFFFF)

The profile-specific objects have the same meaning for all EtherCAT slaves that support the profile 5001.

5.6.6.1.3.1 Input data

Index 6000 AI inputs

Index (hex)	Name	Meaning	Data type	Flags	Default
6000:0	AI inputs	Maximum subindex	INT16	RO	0x11 (17 _{dec})
6000:01	Underrange	Value below measuring range.	BOOLEAN	RO	0x00 (0 _{dec})
6000:02	Overrange	Measuring range exceeded.	BOOLEAN	RO	0x00 (0 _{dec})
6000:03	Limit 1	Limit value monitoring Limit 1 0: not active 1: value is smaller than limit value 1 2: value is larger than limit value 1 3: Value is equal to limit value 1	BIT2	RO	0x00 (0 _{dec})
6000:05	Limit 2	Limit value monitoring limit 2 0: not active 1: value is smaller than limit value 2 2: value is larger than limit value 2 3: Value is equal to limit value 2	BIT2	RO	0x00 (0 _{dec})
6000:07	Error	The error bit is set if the data is invalid (over-range, under-range)	BOOLEAN	RO	0x00 (0 _{dec})
6000:0E	Sync error	The Sync error bit is only required for DC mode. It indicates whether a synchronization error has occurred during the previous cycle. This means a SYNC signal was triggered in the EL31xx, although no new process data were available (0=OK, 1=NOK).	BOOLEAN	RO	0x00 (0 _{dec})
6000:0F	TxPDO State	Validity of the data of the associated TxPDO (0 = valid, 1 = invalid).	BOOLEAN	RO	0x00 (0 _{dec})
60n0:10	TxPDO Toggle	The TxPDO toggle is toggled by the slave when the data of the associated TxPDO is updated.	BOOLEAN	RO	0x00 (0 _{dec})
60n0:11	Value	Analog input date	INT16	RO	0x0000 (0 _{dec})

5.6.6.1.3.2 Configuration data (vendor-specific)

Index 800F AI vendor data

Index (hex)	Name	Meaning	Data type	Flags	Default
800F:0	AI vendor data	Maximum subindex	UINT8	RO	0x02 (2 _{dec})
800F:01	Calibration offset	Offset (vendor calibration)	INT16	RW	0x0000 (0 _{dec})
800F:02	Calibration gain	Gain (vendor calibration)	INT16	RW	0x4000 (16384 _{dec})

5.6.6.1.3.3 Information and diagnostic data

Index 800E AI internal data

Index (hex)	Name	Meaning	Data type	Flags	Default
800E:0	AI internal data	Maximum subindex	UINT8	RO	0x01 (1 _{dec})
800E:01	ADC raw value	ADC raw value	UINT16	RO	-

Index F000*** Modular device profile

Index (hex)	Name	Meaning	Data type	Flags	Default
F000:0	Modular device profile	General information for the modular device profile	UINT8	RO	0x02 (2 _{dec})
F000:01	Module index distance	Index spacing of the objects of the individual channels	UINT16	RO	0x0010 (16 _{dec})
F000:02	Maximum number of modules	Number of channels	UINT16	RO	<i>Max. Channels number of the terminal</i>

***) since revision no. EL31xx-00xx-0016

Index F008* Code word**

Index	Name	Meaning	Data type	Flags	Default
F008:0	Code word	reserved	UINT32	RW	0x00000000 (0 _{dec})

***) since revision no. EL31xx-00xx-0016

Index F009* Password protection**

Index (hex)	Name	Meaning	Data type	Flags	Default
F009:0	Password protection	Password protection user calibration [▶ 259]	UINT32	RW	0x00000000 (0 _{dec})

***) for EL31xx, see [note \[\[▶ 259\]\(#\)\]](#)

Index F010* module list (for $1 \leq n \leq 4$, depends on number of channels)**

Index (hex)	Name	Meaning	Data type	Flags	Default
F010:0	Module list	Maximum subindex	UINT8	RW	0x0n
F010:0n	SubIndex 00n	Analog input profile (300)	UINT32	RW	0x0000012C (300 _{dec})

***) since revision no. EL31xx-00xx-0016

5.6.6.1.4 Standard objects**Standard objects (0x1000-0x1FFF)**

The standard objects have the same meaning for all EtherCAT slaves.

Index 1000 Device type

Index (hex)	Name	Meaning	Data type	Flags	Default
1000:0	Device type	Device type of the EtherCAT slave: the Lo-Word contains the CoE profile used (5001). The Hi-Word contains the module profile according to the modular device profile.	UINT32	RO	0x012C1389 (19665801 _{dec})

Index 1008 Device name

Index (hex)	Name	Meaning	Data type	Flags	Default
1008:0	Device name	Device name of the EtherCAT slave	STRING	RO	EL31xx

Index 1009 Hardware version

Index (hex)	Name	Meaning	Data type	Flags	Default
1009:0	Hardware version	Hardware version of the EtherCAT slave	STRING	RO	00

Index 100A Software version

Index (hex)	Name	Meaning	Data type	Flags	Default
100A:0	Software version	Firmware version of the EtherCAT slave	STRING	RO	-

Index 1018 Identity

Index (hex)	Name	Meaning	Data type	Flags	Default
1018:0	Identity	Information for identifying the slave	UINT8	RO	0x04 (4 _{dec})
1018:01	Vendor ID	Vendor ID of the EtherCAT slave	UINT32	RO	0x00000002 (2 _{dec})
1018:02	Product code	Product code of the EtherCAT slave	UINT32	RO	0xFFFF3052
1018:03	Revision	Revision number of the EtherCAT slave; the low word (bit 0-15) indicates the special terminal number, the high word (bit 16-31) refers to the device description	UINT32	RO	-
1018:04	Serial number	Serial number of the EtherCAT slave; the low byte (bit 0-7) of the low word contains the year of production, the high byte (bit 8-15) of the low word contains the week of production, the high word (bit 16-31) is 0	UINT32	RO	-

Index 10F0* Backup parameter handling**

Index (hex)	Name	Meaning	Data type	Flags	Default
10F0:0	Backup parameter handling	Information for standardized loading and saving of backup entries	UINT8	RO	0x01 (1 _{dec})
10F0:01	Checksum	Checksum across all backup entries of the EtherCAT slave	UINT32	RO	-

***) since revision no. EL31xx-00xx-0016

Index 1800 AI TxPDO-Par Standard Ch.1

Index (hex)	Name	Meaning	Data type	Flags	Default
1800:0	AI TxPDO-Par Standard Ch.1	PDO parameter TxPDO 1	UINT8	RO	0x06 (6 _{dec})
1800:06	Exclude TxPDOs	Specifies the TxPDOs (index of TxPDO mapping objects) that must not be transferred together with TxPDO 1	OCTET-STRING[2]	RO	01 1A

Index 1801 AI TxPDO-Par Compact Ch.1

Index (hex)	Name	Meaning	Data type	Flags	Default
1801:0	AI TxPDO-Par Compact Ch.1	PDO parameter TxPDO 2	UINT8	RO	0x06 (6 _{dec})
1801:06	Exclude TxPDOs	Specifies the TxPDOs (index of TxPDO mapping objects) that must not be transferred together with TxPDO 2	OCTET-STRING[2]	RO	00 1A

Index 1A0n AI TxPDO-Map Standard (for n = 0, 2, 4, 6; p = 0, 1, 2, 3; depending on the number of channels, *not applicable for EL31x2*)

Index (hex)	Name	Meaning	Data type	Flags	Default
1A0n:0	AI TxPDO-Map standard	PDO Mapping TxPDO	UINT8	RO	0x0B (11 _{dec})
1A0n:01	SubIndex 001	1. PDO Mapping entry (object 0x60p0 (AI Inputs), entry 0x01 (Underrange))	UINT32	RO	0x60p0:01, 1
1A0n:02	SubIndex 002	2. PDO Mapping entry (object 0x60p0 (AI Inputs), entry 0x02 (Overrange))	UINT32	RO	0x60p0:02, 1
1A0n:03	SubIndex 003	3. PDO Mapping entry (object 0x60p0 (AI Inputs), entry 0x03 (Limit 1))	UINT32	RO	0x60p0:03, 2
1A0n:04	SubIndex 004	4. PDO Mapping entry (object 0x60p0 (AI Inputs), entry 0x05 (Limit 2))	UINT32	RO	0x60p0:05, 2
1A0n:05	SubIndex 005	5. PDO Mapping entry (object 0x60p0 (AI Inputs), entry 0x07 (Error))	UINT32	RO	0x60p0:07, 2
1A0n:06	SubIndex 006	6. PDO Mapping entry (1 bit align)	UINT32	RO	0x0000:00, 1
1A0n:07	SubIndex 007	7. PDO Mapping entry (5 bits align)	UINT32	RO	0x0000:00, 5
1A0n:08	SubIndex 008	8. PDO Mapping entry (object 0x1C32 (SM input parameter), entry 0x20 (Sync error))	UINT32	RO	0x1C32:20, 1
1A0n:09	SubIndex 009	9. PDO Mapping entry (object 0x180n (AI TxPDO-Par standard), entry 0x07 (TxPDO State))	UINT32	RO	0x180n:07, 1
1A0n:0A	SubIndex 010	10. PDO Mapping entry (object 0x180n (AI TxPDO-Par standard), entry 0x09 (TxPDO Toggle))	UINT32	RO	0x180n:09, 1
1A0n:0B	SubIndex 011	11. PDO Mapping entry (object 0x60p0 (AI Inputs), entry 0x11 (Value))	UINT32	RO	0x60p0:11, 16

Index 1A01 AI TxPDO-Map Compact Ch.1

Index (hex)	Name	Meaning	Data type	Flags	Default
1A01:0	AI TxPDO-Map Compact Ch.1	PDO Mapping TxPDO 2	UINT8	RO	0x01 (1 _{dec})
1A01:01	SubIndex 001	1. PDO Mapping entry (object 0x6000 (AI Inputs), entry 0x11 (Value))	UINT32	RO	0x6000:11, 16

Index 1C00 Sync manager type

Index (hex)	Name	Meaning	Data type	Flags	Default
1C00:0	Sync manager type	Using the sync managers	UINT8	RO	0x04 (4 _{dec})
1C00:01	SubIndex 001	Sync-Manager Type Channel 1: Mailbox Write	UINT8	RO	0x01 (1 _{dec})
1C00:02	SubIndex 002	Sync-Manager Type Channel 2: Mailbox Read	UINT8	RO	0x02 (2 _{dec})
1C00:03	SubIndex 003	Sync-Manager Type Channel 3: Process Data Write (Outputs)	UINT8	RO	0x03 (3 _{dec})
1C00:04	SubIndex 004	Sync-Manager Type Channel 4: Process Data Read (Inputs)	UINT8	RO	0x04 (4 _{dec})

Index 1C12 RxPDO assign

Index (hex)	Name	Meaning	Data type	Flags	Default
1C12:0	RxPDO assign	PDO Assign Outputs	UINT8	RW	0x00 (0 _{dec})

Index 1C13 TxPDO assign (not applicable for EL31x2)

For operation on masters other than TwinCAT it must be ensured that the channels are entered in the PDO assignment ("TxPDO assign", object 0x1C13) successively.

Index (hex)	Name	Meaning	Data type	Flags	Default
1C13:0	TxPDO assign	PDO Assign Inputs	UINT8	RW	0x04 (4 _{dec})
1C13:01	SubIndex 001	1. allocated TxPDO (contains the index of the associated TxPDO mapping object)	UINT16	RW	0x1A00 (6656 _{dec})
1C13:02*	SubIndex 002	2. allocated TxPDO (contains the index of the associated TxPDO mapping object)	UINT16	RW	0x1A02 (6658 _{dec})
1C13:03*	SubIndex 003	3. allocated TxPDO (contains the index of the associated TxPDO mapping object)	UINT16	RW	0x1A04 (6660 _{dec})
1C13:04*	SubIndex 004	4. allocated TxPDO (contains the index of the associated TxPDO mapping object)	UINT16	RW	0x1A06 (6662 _{dec})

*) only for EL31x4

Index 1C33 SM input parameter

Index (hex)	Name	Meaning	Data type	Flags	Default
1C33:0	SM input parameter	Synchronization parameters for the inputs	UINT8	RO	0x20 (32 _{dec})
1C33:01	Sync mode	Current synchronization mode: <ul style="list-style-type: none"> • Bit 0 = 0: Free Run • Bit 0 = 1: Synchron with SM 2 Event • Bit 15 = 0: Standard • Bit 15 = 1: FastOp mode (CoE deactivated) 	UINT16	RW	0x0000 (0 _{dec})
1C33:02	Cycle time	Cycle time (in ns): <ul style="list-style-type: none"> • Free Run: Cycle time of the local timer • Synchronous with SM 2 event: Master cycle time • DC-Mode: SYNC0/SYNC1 Cycle Time 	UINT32	RW	0x000F4240 (1000000 _{dec})
1C33:03	Shift time	Time between SYNC0 event and reading of the inputs (in ns, only DC mode)	UINT32	RO	0x00000000 (0 _{dec})
1C33:04	Sync modes supported	Supported synchronization modes: <ul style="list-style-type: none"> • Bit 0: free run is supported • Bit 1: synchronous with SM 2 event is supported (outputs available) • Bit 1: synchronous with SM 3 event is supported (no outputs available) • Bit 2-3 = 01: DC mode is supported • Bit 4-5 = 01: input shift through local event (outputs available) • Bit 4-5 = 10: input shift with SYNC1 event (no outputs available) • Bit 14 = 1: dynamic times (measurement through writing of 0x1C33:08) 	UINT16	RO	0xC003 (49155 _{dec})
1C33:05	Minimum cycle time	Minimum cycle time (in ns)	UINT32	RO	0x0000FDE8 (65000 _{dec})
1C33:06	Calc and copy time	Time between reading of the inputs and availability of the inputs for the master (in ns, only DC mode)	UINT32	RO	0x00000000 (0 _{dec})
1C33:07	Minimum delay time		UINT32	RO	0x00000000 (0 _{dec})
1C33:08	Get cycle time	With this entry the real required process data provision time can be measured. <ul style="list-style-type: none"> • 0: Measurement of the local cycle time is stopped • 1: Measurement of the local cycle time is started The entries 0x1C33:03, 0x1C33:06, 1C33:09 are updated with the maximum measured values. For a subsequent measurement the measured values are reset.	UINT16	RW	0x0000 (0 _{dec})
1C33:09	Maximum delay time	Time between SYNC1 event and reading of the inputs (in ns, only DC mode)	UINT32	RO	0x00000000 (0 _{dec})
1C33:0B	SM event missed counter	Number of missed SM events in OPERATIONAL (DC mode only)	UINT16	RO	0x0000 (0 _{dec})
1C33:0C	Cycle exceeded counter	Number of occasions the cycle time was exceeded in OPERATIONAL (cycle was not completed in time or the next cycle began too early)	UINT16	RO	0x0000 (0 _{dec})
1C33:0D	Shift too short counter	Number of occasions that the interval between SYNC0 and SYNC1 event was too short (DC mode only)	UINT16	RO	0x0000 (0 _{dec})
1C33:20	Sync error	The synchronization was not correct in the last cycle (outputs were output too late; DC mode only)	BOOLEAN	RO	0x00 (0 _{dec})

Index F009 password protection

Index (hex)	Name	Meaning	Data type	Flags	Default
F009:0	Password protection ▶ 259	Password protection for user calibration	UINT32	RW	0x00000000 (0 _{dec})

5.6.6.2 EL3162

5.6.6.2.1 Restore object

Index 1011 Restore default parameters

Index (hex)	Name	Meaning	Data type	Flags	Default
1011:0	Restore default parameters ▶ 503	Restore default parameters	UINT8	RO	0x01 (1 _{dec})
1011:01	SubIndex 001	If this object is set to "0x64616F6C" in the set value dialog, all backup objects are reset to their delivery state.	UINT32	RW	0x00000000 (0 _{dec})

5.6.6.2.2 Configuration data

Index 40n0* producer code word (for n = 4 [channel 1], n = 8 [channel 2])

● Producer code word

i The vendor reserves the authority for the basic calibration of the terminals. The Producer code word is therefore at present reserved.

*) up to rev. no. EL31x2-0000-0016, only for EL31x2, see [note regarding EL31x2 terminals before rev. no. EL31x2-0000-0016 ▶ 278](#)

Index 40n1 ADC raw value (for n = 4 [channel 1], n = 8 [channel 2])

(up to rev. no. EL31x2-0000-0016, only for EL31x2, see [note ▶ 278](#))

Index (hex)	Name	Meaning	Flags	Default
40n1:0	ADC raw value	Length of this object	RO	1 _{dec}
40n1:01	ADC rawdata	This is the circuit's raw ADC value. It is converted to a measurement through a calculation with the gain and offset from the calibration.	RO	-

Index 40n1 feature bits (for n = 6 [channel 1], n = A [channel 2])

(up to rev. no. EL31x2-0000-0016, only for EL31x2, see [note ▶ 278](#))

Index (hex)	Name	Meaning	Flags	Default	
40n1:0	Feature bits	Length of this object	RW	3 _{dec}	
40n1:01	Enable user scale	TRUE	User scaling (index 40n2 ▶ 437) is active.	RW	FALSE
		FALSE	The user scaling is deactivated.		
40n1:02	Enable absolute with MSB as sign	TRUE	The measured value is output in magnitude-sign format.	RW	FALSE
			EL3102		
		EL3142-0010	+10 mA = 0x7FFF -10 mA = 0xFFFF		
		FALSE	The measured value is output as signed integer in the two's complement		
EL3142-0010	+10 mA = 0x7FFF -10 mA = 0x8001				
40n1:03	Enable filter	TRUE	The digital filter (index 40n5 ▶ 437 , filter settings) is active. The analog values are not converted synchronously with the exchange of process data, but in accordance with the filter setting.	RW	FALSE
		FALSE	The analog values are converted synchronously with the exchange of process data; a digital filter is not active.		

Index 40n2 calibration data (for n = 4 [channel 1], n = 8 [channel 2])

(up to rev. no. EL31x2-0000-0016, only for EL31x2, see [note ▶ 278](#))

Index (hex)	Name	Meaning	Flags	Default
40n2:0	Calibration data	Length of this object	RW	2 _{dec}
40n2:01	Offset 16 bit signed integer	These objects are used to trim the tolerances of the components to determine the measured value. The values can only be changed if the producer code word is set (index 40n0 [▶ 436]).	Offset trim channel 1/ channel 2	0xXXXX
40n2:02	Gain 16 bit unsigned integer		Gain trim channel 1/ channel 2	0xXXXX

**Index 40n2 user scale (for n = 4 [channel 1], n = A [channel 2])
(Feature bit 40n1:01 enabled) 40n1:01 [▶ 436]**

(up to rev. no. EL31x2-0000-0016, only for EL31x2, see note [▶ 278])

Index (hex)	Name	Meaning	Flags	Default
40n2:0	User scale	Length of this object	RW	2 _{dec}
40n2:01	Offset 16 bit signed integer	These objects contain the user scaling.	Offset trim, user scaling channel 1/ channel 2	0x0000
40n2:02	Gain 32 bit signed integer	The scaling is enabled via 40n1:01 [▶ 436].	Gain trim, user scaling channel 1/ channel 2 The gain is represented in fixed-point format, with the factor 2 ⁻¹⁶ . A value of 1 for the gain factor therefore corresponds to 65536 _{dec} (0x00010000).	0x00010000

**Index 40n5 filter settings (for n = 4 [channel 1], n = A [channel 2])
(Feature bit 40n1:03 enabled)40n1:03 [▶ 436]**

(up to rev. no. EL31x2-0000-0016, only for EL31x2, see note [▶ 278])

Enum value	Decimal value	Description	Default
50 Hz FIR	0	50 Hz FIR over 32 values; 50 Hz interferences are suppressed with 60 dB	50 Hz FIR (0 _{dec})
60 Hz FIR	1	60 Hz FIR over 32 values; 60 Hz interferences are suppressed with 40 dB	
IIR Level 1	2	Recursive filter, t _{rise_90%} ** = 0.72 ms	
IIR Level 2	3	Recursive filter, t _{rise_90%} = 1.62 ms	
IIR Level 3	4	Recursive filter, t _{rise_90%} = 3.24 ms	
IIR Level 4	5	Recursive filter, t _{rise_90%} = 6.48 ms	
IIR Level 5	6	Recursive filter, t _{rise_90%} = 12.96 ms	
IIR Level 6	7	Recursive filter, t _{rise_90%} = 25.92 ms	
IIR Level 7	8	Recursive filter, t _{rise_90%} = 51.84 ms	
IIR Level 8	9	Recursive filter, t _{rise_90%} = 103.68 ms	

**) step in rise time [t_{rise_90%}]

Index 80n0*** AI settings (for $0 \leq n \leq 1$)

Index (hex)	Name	Meaning	Data type	Flags	Default
80n0:0	AI Settings	Maximum subindex	UINT8	RO	0x18 (24 _{dec})
80n0:01	Enable user scale [▶ 269]	User scale is active.	BOOLEAN	RW	0x00 (0 _{dec})
80n0:02	Presentation [▶ 244]	0: Signed presentation 1: Unsigned presentation 2: Absolute value with MSB as sign Signed amount representation	BIT3	RW	0x00 (0 _{dec})
80n0:05	Siemens bits [▶ 246]	The S5 bits are displayed in the three low-order bits	BOOLEAN	RW	0x00 (0 _{dec})
80n0:06	Enable filter	Enable filter, which makes PLC-cycle-synchronous data exchange unnecessary	BOOLEAN	RW	0x00 (0 _{dec})
80n0:07	Enable limit 1 [▶ 246]	Limit 1 enabled	BOOLEAN	RW	0x00 (0 _{dec})
80n0:08	Enable limit 2 [▶ 246]	Limit 2 enabled	BOOLEAN	RW	0x00 (0 _{dec})
80n0:0A	Enable user calibration [▶ 269]	Enabling of the user calibration	BOOLEAN	RW	0x00 (0 _{dec})
80n0:0B	Enable vendor calibration [▶ 269]	Enabling of the vendor calibration	BOOLEAN	RW	0x01 (1 _{dec})
80n0:0E	Swap limit bits [▶ 247]	Changing of the Limit Bits	BOOLEAN	RW	0x00 (0 _{dec})
80n0:11	User scale offset [▶ 269]	User scaling offset	INT16	RW	0x0000 (0 _{dec})
80n0:12	User scale gain [▶ 269]	User scaling gain. The gain is represented in fixed-point format, with the factor 2^{-16} . The value 1 corresponds to 65536 _{dec} (0x00010000) and is limited to $\pm 0x7FFFF$	INT32	RW	0x00010000 (65536 _{dec})
80n0:13	Limit 1 [▶ 246]	First limit value for setting the status bits	INT16	RW	0x0000 (0 _{dec})
80n0:14	Limit 2 [▶ 246]	Second limit value for setting the status bits	INT16	RW	0x0000 (0 _{dec})
80n0:15	Filter settings	This object determines the digital filter settings, if it is active via Enable filter (index 0x80n0:06 [▶ 438]). The possible settings are sequentially numbered. 0: 50 Hz FIR 1: 60 Hz FIR 2: IIR 1 3: IIR 2 4: IIR 3 5: IIR 4 6: IIR 5 7: IIR 6 8: IIR 7 9: IIR 8	UINT16	RW	0x0000 (0 _{dec})
80n0:17	User calibration offset [▶ 269]	User offset compensation	INT16	RW	0x0000 (0 _{dec})
80n0:18	User calibration gain [▶ 269]	User calibration gain	INT16	RW	0x4000 (16384 _{dec})

***) since revision no. EL31xx-00xx-0016



The filter characteristics are set via index **0x8000:15 [▶ 438]**

The filter frequencies are set for all channels of the EL31xx terminals centrally via index **0x8000:15 [▶ 438]** (channel 1). All other corresponding indices 0x80n0:15 have no parameterization function!

5.6.6.2.3 Profile-specific objects (0x6000-0xFFFF)

The profile-specific objects have the same meaning for all EtherCAT slaves that support the profile 5001.

5.6.6.2.3.1 Input data

Index 3101 inputs (channel 1)

(up to rev. no. EL31x2-0000-0016, only for EL31x2, see [note \[► 278\]](#))

Index (hex)	Name	Meaning	Flags	Default
3101:0	Inputs	Length of this object	RO	2 _{dec}
3101:01	Status	Status byte [► 254] channel 1	RO	-
3101:02	Value	Input process data channel 1	RO	-

Index 3102 inputs (channel 2)

(up to rev. no. EL31x2-0000-0016, only for EL31x2, see [note \[► 278\]](#))

Index (hex)	Name	Meaning	Flags	Default
3102:0	Inputs	Length of this object	RO	2 _{dec}
3102:01	Status	Status byte [► 254] channel 2	RO	-
3102:02	Value	Input process data channel 2	RO	-

Index 60n0*** AI inputs (for 0 ≤ n ≤ 1)

Index (hex)	Name	Meaning	Data type	Flags	Default
60n0:0	AI inputs	Maximum subindex	INT16	RO	0x11 (17 _{dec})
60n0:01	Underrange	Value below measuring range.	BOOLEAN	RO	0x00 (0 _{dec})
60n0:02	Overrange	Measuring range exceeded.	BOOLEAN	RO	0x00 (0 _{dec})
60n0:03	Limit 1	Limit value monitoring Limit 1 0: not active 1: value is smaller than limit value 1 2: value is larger than limit value 1 3: Value is equal to limit value 1	BIT2	RO	0x00 (0 _{dec})
60n0:05	Limit 2	Limit value monitoring limit 2 0: not active 1: value is smaller than limit value 2 2: value is larger than limit value 2 3: Value is equal to limit value 2	BIT2	RO	0x00 (0 _{dec})
60n0:07	Error	The error bit is set if the data is invalid (over-range, under-range)	BOOLEAN	RO	0x00 (0 _{dec})
60n0:0E	Sync error	The Sync error bit is only required for DC mode. It indicates whether a synchronization error has occurred during the previous cycle. This means a SYNC signal was triggered in the EL31xx, although no new process data were available (0=OK, 1=NOK).	BOOLEAN	RO	0x00 (0 _{dec})
60n0:0F	TxPDO State	Validity of the data of the associated TxPDO (0 = valid, 1 = invalid).	BOOLEAN	RO	0x00 (0 _{dec})
60n0:10	TxPDO Toggle	The TxPDO toggle is toggled by the slave when the data of the associated TxPDO is updated.	BOOLEAN	RO	0x00 (0 _{dec})
60n0:11	Value	Analog input date	INT16	RO	0x0000 (0 _{dec})

***) since revision no. EL31xx-00xx-0016

Index 6401 inputs (channels 1 & 2)

(up to rev. no. EL31x2-0000-0016, only for EL31x2, see [note \[► 278\]](#))

Index (hex)	Name	Meaning	Flags	Default
6401:0	Inputs	Length of this object	RO	2 _{dec}
6401:01	Value channel 1	Input process data channel 1	RO	-
6401:02	Value channel 2	Input process data channel 2	RO	-

5.6.6.2.3.2 Configuration data (vendor-specific)

Index 80nF*** AI vendor data (for $0 \leq n \leq 1$)

Index (hex)	Name	Meaning	Data type	Flags	Default
80nF:0	AI vendor data	Maximum subindex	UINT8	RO	0x02 (2 _{dec})
80nF:01	Calibration offset	Offset (vendor calibration)	INT16	RW	0x0000 (0 _{dec})
80nF:02	Calibration gain	Gain (vendor calibration)	INT16	RW	0x4000 (16384 _{dec})

***) since revision no. EL31xx-00xx-0016

5.6.6.2.3.3 Information and diagnostic data

Index 80nE*** AI internal data (for $0 \leq n \leq 1$)

Index (hex)	Name	Meaning	Data type	Flags	Default
80nE:0	AI internal data	Maximum subindex	UINT8	RO	0x01 (1 _{dec})
80nE:01	ADC raw value	ADC raw value	UINT16	RO	-

***) since revision no. EL31xx-00xx-0016

Index F000*** Modular device profile

Index (hex)	Name	Meaning	Data type	Flags	Default
F000:0	Modular device profile	General information for the modular device profile	UINT8	RO	0x02 (2 _{dec})
F000:01	Module index distance	Index spacing of the objects of the individual channels	UINT16	RO	0x0010 (16 _{dec})
F000:02	Maximum number of modules	Number of channels	UINT16	RO	<i>Max. Channels number of the terminal</i>

***) since revision no. EL31xx-00xx-0016

Index F008*** Code word

Index	Name	Meaning	Data type	Flags	Default
F008:0	Code word	reserved	UINT32	RW	0x00000000 (0 _{dec})

***) since revision no. EL31xx-00xx-0016

Index F009*** Password protection

Index (hex)	Name	Meaning	Data type	Flags	Default
F009:0	Password protection	Password protection user calibration [► 259]	UINT32	RW	0x00000000 (0 _{dec})

***) for EL31xx, see [note \[► 259\]](#)

Index F010*** module list (for $1 \leq n \leq 4$, depends on number of channels)

Index (hex)	Name	Meaning	Data type	Flags	Default
F010:0	Module list	Maximum subindex	UINT8	RW	0x0n
F010:0n	SubIndex 00n	Analog input profile (300)	UINT32	RW	0x0000012C (300 _{dec})

***) since revision no. EL31xx-00xx-0016

5.6.6.2.4 Standard objects

Standard objects (0x1000-0x1FFF)

The standard objects have the same meaning for all EtherCAT slaves.

Index 1000 Device type

Index (hex)	Name	Meaning	Data type	Flags	Default
1000:0	Device type	Device type of the EtherCAT slave: the Lo-Word contains the CoE profile used (5001). The Hi-Word contains the module profile according to the modular device profile.	UINT32	RO	0x00001389 (5001 _{dec})

Index 1008 Device name

Index (hex)	Name	Meaning	Data type	Flags	Default
1008:0	Device name	Device name of the EtherCAT slave	STRING	RO	EL31xx

Index 1009 Hardware version

Index (hex)	Name	Meaning	Data type	Flags	Default
1009:0	Hardware version	Hardware version of the EtherCAT slave	STRING	RO	00

Index 100A Software version

Index (hex)	Name	Meaning	Data type	Flags	Default
100A:0	Software version	Firmware version of the EtherCAT slave	STRING	RO	-

Index 1018 Identity

Index (hex)	Name	Meaning	Data type	Flags	Default
1018:0	Identity	Information for identifying the slave	UINT8	RO	0x04 (4 _{dec})
1018:01	Vendor ID	Vendor ID of the EtherCAT slave	UINT32	RO	0x00000002 (2 _{dec})
1018:02	Product code	Product code of the EtherCAT slave	UINT32	RO	0xFFFF3052
1018:03	Revision	Revision number of the EtherCAT slave; the low word (bit 0-15) indicates the special terminal number, the high word (bit 16-31) refers to the device description	UINT32	RO	-
1018:04	Serial number	Serial number of the EtherCAT slave; the low byte (bit 0-7) of the low word contains the year of production, the high byte (bit 8-15) of the low word contains the week of production, the high word (bit 16-31) is 0	UINT32	RO	-

Index 10F0*** Backup parameter handling

Index (hex)	Name	Meaning	Data type	Flags	Default
10F0:0	Backup parameter handling	Information for standardized loading and saving of backup entries	UINT8	RO	0x01 (1 _{dec})
10F0:01	Checksum	Checksum across all backup entries of the EtherCAT slave	UINT32	RO	-

***) since revision no. EL31xx-00xx-0016

Index 1800 TxPDO-Par Ch.1

Index (hex)	Name	Meaning	Data type	Flags	Default
1800:0	TxPDO-Par Ch.1	PDO Parameter TxPDO	UINT8	RO	0x06 (6 _{dec})
1800:06	Exclude TxPDOs	Hier sind die TxPDOs (Index der TxPDO Mapping Objekte) angegeben, die nicht zusammen mit TxPDO 1 übertragen werden dürfen	OCTET-STRING[2]	RO	02 1A 03 1A 07 1A 10 1A

Index 1801 TxPDO-Par Ch.2

Index (hex)	Name	Meaning	Data type	Flags	Default
1801:0	TxPDO-Par Ch.2	PDO Parameter TxPDO	UINT8	RO	0x06 (6 _{dec})
1801:06	Exclude TxPDOs	Hier sind die TxPDOs (Index der TxPDO Mapping Objekte) angegeben, die nicht zusammen mit TxPDO 2 übertragen werden dürfen	OCTET-STRING[2]	RO	04 1A 05 1A 09 1A 10 1A

Index 1802 AI TxPDO-Par Standard Ch.2

Index (hex)	Name	Meaning	Data type	Flags	Default
1802:0	AI TxPDO-Par Standard Ch.2	PDO parameter TxPDO 3	UINT8	RO	0x06 (6 _{dec})
1802:06	Exclude TxPDOs	Specifies the TxPDOs (index of TxPDO mapping objects) that must not be transferred together with TxPDO 3	OCTET-STRING[2]	RO	03 1A

Index 1803 AI TxPDO-Par Compact Ch.1

Index (hex)	Name	Meaning	Data type	Flags	Default
1803:0	AI TxPDO-Par Compact Ch.1	PDO Parameter TxPDO	UINT8	RO	0x06 (6 _{dec})
1803:06	Exclude TxPDOs	Hier sind die TxPDOs (Index der TxPDO Mapping Objekte) angegeben, die nicht zusammen mit TxPDO 2 übertragen werden dürfen	OCTET-STRING[2]	RO	00 1A 02 1A 07 1A 10 1A

Index 1804 AI TxPDO-Par Standard Ch.2

Index (hex)	Name	Meaning	Data type	Flags	Default
1804:0	AI TxPDO-Par Standard Ch.2	PDO Parameter TxPDO	UINT8	RO	0x06 (6 _{dec})
1804:06	Exclude TxPDOs	Hier sind die TxPDOs (Index der TxPDO Mapping Objekte) angegeben, die nicht zusammen mit TxPDO 3 übertragen werden dürfen	OCTET-STRING[2]	RO	00 1A 05 1A 09 1A 10 1A

Index 1805 AI TxPDO-Par Compact Ch.2

Index (hex)	Name	Meaning	Data type	Flags	Default
1805:0	AI TxPDO-Par Compact Ch.2	PDO Parameter TxPDO	UINT8	RO	0x06 (6 _{dec})
1805:06	Exclude TxPDOs	Hier sind die TxPDOs (Index der TxPDO Mapping Objekte) angegeben, die nicht zusammen mit TxPDO 4 übertragen werden dürfen	OCTET-STRING[2]	RO	00 1A 04 1A 09 1A 10 1A

Index 1810 TxPDO-Par Channels

Index (hex)	Name	Meaning	Data type	Flags	Default
1810:0	TxPDO-Par Channels	PDO Parameter TxPDO	UINT8	RO	0x06 (6 _{dec})
1810:06	Exclude TxPDOs	Hier sind die TxPDOs (Index der TxPDO Mapping Objekte) angegeben, die nicht zusammen mit TxPDO 1 übertragen werden dürfen	OCTET-STRING[2]	RO	00 1A 01 1A 02 1A 03 1A 04 1A 05 1A 07 1A 09 1A

Index 1A00 TxPDO-Par Channel 1 (only for EL31x2)

Index (hex)	Name	Meaning	Data type	Flags	Default
1A0n:0	TxPDO Map Ch. 1	PDO Mapping TxPDO Ch. 1	UINT8	RO	0x02 (2 _{dec})
1A00:01	SubIndex 001	1. PDO Mapping entry (object 0x3101 (Inputs), entry 0x01 (Inputs))	UINT32	RO	0x3101:01, 1
1A00:02	SubIndex 002	2. PDO Mapping entry (object 0x3101 (Inputs), entry 0x02 (Inputs))	UINT32	RO	0x3101:02, 1

Index 1A01 TxPDO-Par Channel 2 (only for EL31x2)

Index (hex)	Name	Meaning	Data type	Flags	Default
1A01:0	TxPDO Map Ch. 1	PDO Mapping TxPDO Ch. 1	UINT8	RO	0x02 (2 _{dec})
1A01:01	SubIndex 001	1. PDO Mapping entry (object 0x3102 (Inputs), entry 0x01 (Inputs))	UINT32	RO	0x3102:01, 1
1A01:02	SubIndex 002	2. PDO Mapping entry (object 0x3102 (Inputs), entry 0x02 (Inputs))	UINT32	RO	0x3102:02, 1

Index 1A02 AI TxPDO-Map Standard Ch.1

Index (hex)	Name	Meaning	Data type	Flags	Default
1A02:0	AI TxPDO-Map Standard Ch.1	PDO Mapping TxPDO	UINT8	RO	0x0B (11 _{dec})
1A02:01	SubIndex 001	1. PDO Mapping entry (object 0x6000 (AI Inputs), entry 0x01 (Underrange))	UINT32	RO	0x6000:01, 1
1A02:02	SubIndex 002	2. PDO Mapping entry (object 0x6000 (AI Inputs), entry 0x02 (Overrange))	UINT32	RO	0x6000:02, 1
1A02:03	SubIndex 003	3. PDO Mapping entry (object 0x6000 (AI Inputs), entry 0x03 (Limit 1))	UINT32	RO	0x6000:03, 2
1A02:04	SubIndex 004	4. PDO Mapping entry (object 0x6000 (AI Inputs), entry 0x05 (Limit 2))	UINT32	RO	0x6000:05, 2
1A02:05	SubIndex 005	5. PDO Mapping entry (object 0x6000 (AI Inputs), entry 0x07 (Error))	UINT32	RO	0x6000:07, 1
1A02:06	SubIndex 006	6. PDO Mapping entry (1 bit align)	UINT32	RO	0x0000:00, 1
1A02:07	SubIndex 007	7. PDO Mapping entry (5 bits align)	UINT32	RO	0x0000:00, 5
1A02:08	SubIndex 008	8. PDO Mapping entry (object 0x6000 (AI Inputs), entry 0x0E (Sync Error))	UINT32	RO	0x6000:0E, 1
1A02:09	SubIndex 009	9. PDO Mapping entry (object 0x6000 (AI Inputs), entry 0x0F (TxPDO State))	UINT32	RO	0x6000:0F, 1
1A02:0A	SubIndex 010	10. PDO Mapping entry (object 0x6000 (AI Inputs), entry 0x10 (TxPDO Toggle))	UINT32	RO	0x6000:10, 1
1A02:0B	SubIndex 011	11. PDO Mapping entry (object 0x6000 (AI Inputs), entry 0x11 (Value))	UINT32	RO	0x6000:11, 16

Index 1A03 AI TxPDO-Map Compact Ch.1

Index (hex)	Name	Meaning	Data type	Flags	Default
1A03:0	AI TxPDO-Map Compact Ch.1	PDO Mapping TxPDO	UINT8	RO	0x01 (1 _{dec})
1A03:01	SubIndex 001	1. PDO Mapping entry (object 0x6000 (AI Inputs), entry 0x11 (Value))	UINT32	RO	0x6000:11, 16

Index 1A04 AI TxPDO-Map Standard Ch.2

Index (hex)	Name	Meaning	Data type	Flags	Default
1A04:0	AI TxPDO-Map Standard Ch.2	PDO Mapping TxPDO	UINT8	RO	0x0B (1 _{dec})
1A04:01	SubIndex 001	1. PDO Mapping entry (object 0x6010 (AI Inputs), entry 0x01 (Underrange))	UINT32	RO	0x6010:01, 1
1A04:02	SubIndex 002	2. PDO Mapping entry (object 0x6010 (AI Inputs), entry 0x02 (Overrange))	UINT32	RO	0x6010:02, 1
1A04:03	SubIndex 003	3. PDO Mapping entry (object 0x6010 (AI Inputs), entry 0x03 (Limit 1))	UINT32	RO	0x6010:03, 2
1A04:04	SubIndex 004	4. PDO Mapping entry (object 0x6010 (AI Inputs), entry 0x05 (Limit 2))	UINT32	RO	0x6010:05, 2
1A04:05	SubIndex 005	5. PDO Mapping entry (object 0x6010 (AI Inputs), entry 0x07 (Error))	UINT32	RO	0x6010:07, 1
1A04:06	SubIndex 006	6. PDO Mapping entry (1 bit align)	UINT32	RO	0x0000:00, 1
1A04:07	SubIndex 007	7. PDO Mapping entry (5 bits align)	UINT32	RO	0x0000:00, 5
1A04:08	SubIndex 008	8. PDO Mapping entry (object 0x6010 (AI Inputs), entry 0x0E (Sync Error))	UINT32	RO	0x6010:0E, 1
1A04:09	SubIndex 009	9. PDO Mapping entry (object 0x6010 (AI Inputs), entry 0x0F (TxPDO State))	UINT32	RO	0x6010:0F, 1
1A04:0A	SubIndex 010	10. PDO Mapping entry (object 0x6010 (AI Inputs), entry 0x10 (TxPDO Toggle))	UINT32	RO	0x6010:10, 1
1A04:0B	SubIndex 011	11. PDO Mapping entry (object 0x6010 (AI Inputs), entry 0x11 (Value))	UINT32	RO	0x6010:11, 16

Index 1A05 AI TxPDO-Map Compact Ch.2

Index (hex)	Name	Meaning	Data type	Flags	Default
1A05:0	AI TxPDO-Map Compact Ch.2	PDO Mapping TxPDO	UINT8	RO	0x01 (1 _{dec})
1A05:01	SubIndex 001	1. PDO Mapping entry (object 0x6010 (AI Inputs), entry 0x11 (Value))	UINT32	RO	0x6010:11, 16

Index 1A10 TxPDO-Map Channels

Index (hex)	Name	Meaning	Data type	Flags	Default
1A10:0	TxPDO-Map Channels	PDO Mapping TxPDO	UINT8	RO	0x02 (2 _{dec})
1A10:01	SubIndex 001	1. PDO Mapping entry (object 0x3101 (Inputs), entry 0x01 (Inputs))	UINT32	RO	0x3101:02, 16
1A10:02	SubIndex 002	2. PDO Mapping entry (object 0x3101 (Inputs), entry 0x02 (Inputs))	UINT32	RO	0x3101:02, 16

Index 1C00 Sync manager type

Index (hex)	Name	Meaning	Data type	Flags	Default
1C00:0	Sync manager type	Using the sync managers	UINT8	RO	0x04 (4 _{dec})
1C00:01	SubIndex 001	Sync-Manager Type Channel 1: Mailbox Write	UINT8	RO	0x01 (1 _{dec})
1C00:02	SubIndex 002	Sync-Manager Type Channel 2: Mailbox Read	UINT8	RO	0x02 (2 _{dec})
1C00:03	SubIndex 003	Sync-Manager Type Channel 3: Process Data Write (Outputs)	UINT8	RO	0x03 (3 _{dec})
1C00:04	SubIndex 004	Sync-Manager Type Channel 4: Process Data Read (Inputs)	UINT8	RO	0x04 (4 _{dec})

Index 1C12 RxPDO assign

Index (hex)	Name	Meaning	Data type	Flags	Default
1C12:0	RxPDO assign	PDO Assign Outputs	UINT8	RW	0x00 (0 _{dec})

Index 1C13 TxPDO assign (only for EL31x2 before rev. EL31x2-0000-0016)

For operation on masters other than TwinCAT it must be ensured that the channels are entered in the PDO assignment ("TxPDO assign", object 0x1C13) successively.

Index (hex)	Name	Meaning	Data type	Flags	Default
1C13:0	TxPDO assign	PDO Assign Inputs	UINT8	RW	0x02 (2 _{dec})
1C13:01	SubIndex 001	1. allocated TxPDO (contains the index of the associated TxPDO mapping object)	UINT16	RW	0x1A02
1C13:02	SubIndex 002	2. allocated TxPDO (contains the index of the associated TxPDO mapping object)	UINT16	RW	0x1A04

Index 1C13 TxPDO assign (only for EL31x2 from rev. EL31x2-0000-0016)

For operation on masters other than TwinCAT it must be ensured that the channels are entered in the PDO assignment ("TxPDO assign", object 0x1C13) successively.

Index (hex)	Name	Meaning	Data type	Flags	Default
1C13:0	TxPDO assign	PDO Assign Inputs	UINT8	RW	0x02 (2 _{dec})
1C13:01	SubIndex 001	1. allocated TxPDO (contains the index of the associated TxPDO mapping object)	UINT16	RW	0x1A00
1C13:02	SubIndex 002	2. allocated TxPDO (contains the index of the associated TxPDO mapping object)	UINT16	RW	0x1A01

Index 1C33*** SM input parameter

Index (hex)	Name	Meaning	Data type	Flags	Default
1C33:0	SM input parameter	Synchronization parameters for the inputs	UINT8	RO	0x20 (32 _{dec})
1C33:01	Sync mode	Current synchronization mode: <ul style="list-style-type: none"> Bit 0 = 0: Free Run Bit 0 = 1: Synchronous with SM 3 event Bit 0-1 = 11: DC with SYNC1 event Bit 15 = 1: Fast mode 	UINT16	RW	0x0022 (34 _{dec})
1C33:02	Cycle time	Cycle time (in ns): <ul style="list-style-type: none"> Free Run: Cycle time of the local timer Synchronous with SM 2 event: Master cycle time DC mode: SYNC0/SYNC1 Cycle Time 	UINT32	RW	0x000F4240 (1000000 _{dec})
1C33:03	Shift time	Time between SYNC0 event and reading of the inputs (in ns, only DC mode)	UINT32	RO	0x000186A0 (100000 _{dec})
1C33:04	Sync modes supported	Supported synchronization modes: <ul style="list-style-type: none"> Bit 0 = 1: Free Run is supported Bit 1: Synchron with SM 3 Event is supported (no Outputs available) Bit 2 = 1: DC mode (SYNC0) Bit 3 = 1: DC mode (SYNC1) Bit 4-5 = 01: Input Shift with local event (Outputs available) Bit 4-5 = 10: Input Shift with SYNC1 Event (no Outputs available) Bit 12 = 1: Legacy Synchron Bit 13 = 1: SM event Bit 14 = 1: dynamic times (measure by writing 1C33:08 [▶ 446]) Bit 15 = 1: Fast mode 	UINT16	RO	0xD00B (53259 _{dec})
1C33:05	Minimum cycle time	Minimum cycle time (in ns)	UINT32	RO	0x000186A0 (100000 _{dec})
1C33:06	Calc and copy time	Time between reading of the inputs and availability of the inputs for the master (in ns, only DC mode)	UINT32	RO	0x00002710 (10000dez)
1C33:08	Command	With this entry the real required process data provision time can be measured. <ul style="list-style-type: none"> 0: Measurement of the local cycle time is stopped 1: Measurement of the local cycle time is started <p>The entries 1C33:03 [▶ 446], 1C33:06 [▶ 446], and 1C33:09 [▶ 446] are updated with the maximum measured values. For a subsequent measurement the measured values are reset</p>	UINT16	RW	0x0000 (0 _{dec})
1C33:09	Maximum Delay time	Time between SYNC1 event and reading of the inputs (in ns, only DC mode)	UINT32	RO	0x000186A0 (100000dez)
1C33:0B	SM event missed counter	Number of missed SM events in OPERATIONAL (DC mode only)	UINT16	RO	0x0000 (0 _{dec})
1C33:0C	Cycle exceeded counter	Number of occasions the cycle time was exceeded in OPERATIONAL (cycle was not completed in time or the next cycle began too early)	UINT16	RO	0x0000 (0 _{dec})
1C33:0D	Shift too short counter	Number of occasions that the interval between SYNC0 and SYNC1 event was too short (DC mode only)	UINT16	RO	0x0000 (0 _{dec})
1C33:20	Sync error	The synchronization was not correct in the last cycle (outputs were output too late; DC mode only)	BOOLEAN	RO	0x00 (0 _{dec})

***) since revision no. EL31xx-00xx-0016

Index F009*** Password protection

Index (hex)	Name	Meaning	Data type	Flags	Default
F009:0	Password protection	Password protection user calibration [▶ 259]	UINT32	RW	0x00000000 (0 _{dec})

***) for EL31xx, see [note \[▶ 259\]](#)

5.6.6.3 EL3164

5.6.6.3.1 Restore object

Index 1011 Restore default parameters

Index (hex)	Name	Meaning	Data type	Flags	Default
1011:0	Restore default parameters [▶ 503]	Restore default parameters	UINT8	RO	0x01 (1 _{dec})
1011:01	SubIndex 001	If this object is set to “0x64616F6C” in the set value dialog, all backup objects are reset to their delivery state.	UINT32	RW	0x00000000 (0 _{dec})

5.6.6.3.2 Configuration data

Index 80n0*** AI settings (for 0 ≤ n ≤ 3)

Index (hex)	Name	Meaning	Data type	Flags	Default
80n0:0	AI Settings	Maximum subindex	UINT8	RO	0x18 (24 _{dec})
80n0:01	Enable user scale [▶ 269]	User scale is active.	BOOLEAN	RW	0x00 (0 _{dec})
80n0:02	Presentation [▶ 244]	0: Signed presentation 1: Unsigned presentation 2: Absolute value with MSB as sign Signed amount representation	BIT3	RW	0x00 (0 _{dec})
80n0:05	Siemens bits [▶ 246]	The S5 bits are displayed in the three low-order bits	BOOLEAN	RW	0x00 (0 _{dec})
80n0:06	Enable filter	Enable filter, which makes PLC-cycle-synchronous data exchange unnecessary	BOOLEAN	RW	0x00 (0 _{dec})
80n0:07	Enable limit 1 [▶ 246]	Limit 1 enabled	BOOLEAN	RW	0x00 (0 _{dec})
80n0:08	Enable limit 2 [▶ 246]	Limit 2 enabled	BOOLEAN	RW	0x00 (0 _{dec})
80n0:0A	Enable user calibration [▶ 269]	Enabling of the user calibration	BOOLEAN	RW	0x00 (0 _{dec})
80n0:0B	Enable vendor calibration [▶ 269]	Enabling of the vendor calibration	BOOLEAN	RW	0x01 (1 _{dec})
80n0:0E	Swap limit bits [▶ 247]	Changing of the Limit Bits	BOOLEAN	RW	0x00 (0 _{dec})
80n0:11	User scale offset [▶ 269]	User scaling offset	INT16	RW	0x0000 (0 _{dec})
80n0:12	User scale gain [▶ 269]	User scaling gain. The gain is represented in fixed-point format, with the factor 2 ⁻¹⁶ . The value 1 corresponds to 65536 _{dec} (0x00010000) and is limited to ±0x7FFFF	INT32	RW	0x00010000 (65536 _{dec})
80n0:13	Limit 1 [▶ 246]	First limit value for setting the status bits	INT16	RW	0x0000 (0 _{dec})
80n0:14	Limit 2 [▶ 246]	Second limit value for setting the status bits	INT16	RW	0x0000 (0 _{dec})
80n0:15	Filter settings	This object determines the digital filter settings, if it is active via Enable filter (index 0x80n0:06 [▶ 448]). The possible settings are sequentially numbered. 0: 50 Hz FIR 1: 60 Hz FIR 2: IIR 1 3: IIR 2 4: IIR 3 5: IIR 4 6: IIR 5 7: IIR 6 8: IIR 7 9: IIR 8	UINT16	RW	0x0000 (0 _{dec})
80n0:17	User calibration offset [▶ 269]	User offset compensation	INT16	RW	0x0000 (0 _{dec})
80n0:18	User calibration gain [▶ 269]	User calibration gain	INT16	RW	0x4000 (16384 _{dec})

***) since revision no. EL31xx-00xx-0016

Filter

The filters of the EL30xx/EL31xx are activated or deactivated via the CoE index 0x8000:15.



The filter characteristics are set via index 0x8000:15

The filter frequencies are set for all channels of the EL30xx/EL31xx terminals centrally via index 0x8000:15 (channel 1). All other corresponding indices 0x80n0:15 have no parameterization function! The latest firmware version (see [status table](#) [▶ 484]) returns an EtherCAT-compliant error message, if the filter characteristics of other channels (index 0x80n0:06, 0x80n0:15) are set.

5.6.6.3.3 Profile-specific objects (0x6000-0xFFFF)

The profile-specific objects have the same meaning for all EtherCAT slaves that support the profile 5001.

5.6.6.3.3.1 Input data

Index 60n0* AI inputs (for 0 ≤ n ≤ 3)**

Index (hex)	Name	Meaning	Data type	Flags	Default
60n0:0	AI inputs	Maximum subindex	INT16	RO	0x11 (17 _{dec})
60n0:01	Underrange	Value below measuring range.	BOOLEAN	RO	0x00 (0 _{dec})
60n0:02	Ovrange	Measuring range exceeded.	BOOLEAN	RO	0x00 (0 _{dec})
60n0:03	Limit 1	Limit value monitoring Limit 1 0: not active 1: value is smaller than limit value 1 2: value is larger than limit value 1 3: Value is equal to limit value 1	BIT2	RO	0x00 (0 _{dec})
60n0:05	Limit 2	Limit value monitoring limit 2 0: not active 1: value is smaller than limit value 2 2: value is larger than limit value 2 3: Value is equal to limit value 2	BIT2	RO	0x00 (0 _{dec})
60n0:07	Error	The error bit is set if the data is invalid (over-range, under-range)	BOOLEAN	RO	0x00 (0 _{dec})
60n0:0E	Sync error	The Sync error bit is only required for DC mode. It indicates whether a synchronization error has occurred during the previous cycle. This means a SYNC signal was triggered in the EL31xx, although no new process data were available (0=OK, 1=NOK).	BOOLEAN	RO	0x00 (0 _{dec})
60n0:0F	TxPDO State	Validity of the data of the associated TxPDO (0 = valid, 1 = invalid).	BOOLEAN	RO	0x00 (0 _{dec})
60n0:10	TxPDO Toggle	The TxPDO toggle is toggled by the slave when the data of the associated TxPDO is updated.	BOOLEAN	RO	0x00 (0 _{dec})
60n0:11	Value	Analog input date	INT16	RO	0x0000 (0 _{dec})

***) since revision no. EL31xx-00xx-0016

5.6.6.3.3.2 Configuration data (vendor-specific)

Index 80nF* AI vendor data (for 0 ≤ n ≤ 3)**

Index (hex)	Name	Meaning	Data type	Flags	Default
80nF:0	AI vendor data	Maximum subindex	UINT8	RO	0x02 (2 _{dec})
80nF:01	Calibration offset	Offset (vendor calibration)	INT16	RW	0x0000 (0 _{dec})
80nF:02	Calibration gain	Gain (vendor calibration)	INT16	RW	0x4000 (16384 _{dec})

***) since revision no. EL31xx-00xx-0016

5.6.6.3.3 Information and diagnostic data

Index 80nE*** AI internal data (for $0 \leq n \leq 3$)

Index (hex)	Name	Meaning	Data type	Flags	Default
80nE:0	AI internal data	Maximum subindex	UINT8	RO	0x01 (1 _{dec})
80nE:01	ADC raw value	ADC raw value	UINT16	RO	-

***) since revision no. EL31xx-00xx-0016

Index F000*** Modular device profile

Index (hex)	Name	Meaning	Data type	Flags	Default
F000:0	Modular device profile	General information for the modular device profile	UINT8	RO	0x02 (2 _{dec})
F000:01	Module index distance	Index spacing of the objects of the individual channels	UINT16	RO	0x0010 (16 _{dec})
F000:02	Maximum number of modules	Number of channels	UINT16	RO	Max. Channels number of the terminal

***) since revision no. EL31xx-00xx-0016

Index F008*** Code word

Index	Name	Meaning	Data type	Flags	Default
F008:0	Code word	reserved	UINT32	RW	0x00000000 (0 _{dec})

***) since revision no. EL31xx-00xx-0016

Index F010*** module list (for $1 \leq n \leq 4$, depends on number of channels)

Index (hex)	Name	Meaning	Data type	Flags	Default
F010:0	Module list	Maximum subindex	UINT8	RW	0x0n
F010:0n	SubIndex 00n	Analog input profile (300)	UINT32	RW	0x0000012C (300 _{dec})

***) since revision no. EL31xx-00xx-0016

5.6.6.3.4 Standard objects

Standard objects (0x1000-0x1FFF)

The standard objects have the same meaning for all EtherCAT slaves.

Index 1000 Device type

Index (hex)	Name	Meaning	Data type	Flags	Default
1000:0	Device type	Device type of the EtherCAT slave: the Lo-Word contains the CoE profile used (5001). The Hi-Word contains the module profile according to the modular device profile.	UINT32	RO	0x012C1389 (19665801 _{dec})

Index 1008 Device name

Index (hex)	Name	Meaning	Data type	Flags	Default
1008:0	Device name	Device name of the EtherCAT slave	STRING	RO	EL31xx

Index 1009 Hardware version

Index (hex)	Name	Meaning	Data type	Flags	Default
1009:0	Hardware version	Hardware version of the EtherCAT slave	STRING	RO	00

Index 100A Software version

Index (hex)	Name	Meaning	Data type	Flags	Default
100A:0	Software version	Firmware version of the EtherCAT slave	STRING	RO	-

Index 1018 Identity

Index (hex)	Name	Meaning	Data type	Flags	Default
1018:0	Identity	Information for identifying the slave	UINT8	RO	0x04 (4 _{dec})
1018:01	Vendor ID	Vendor ID of the EtherCAT slave	UINT32	RO	0x00000002 (2 _{dec})
1018:02	Product code	Product code of the EtherCAT slave	UINT32	RO	0xFFFF3052
1018:03	Revision	Revision number of the EtherCAT slave; the low word (bit 0-15) indicates the special terminal number, the high word (bit 16-31) refers to the device description	UINT32	RO	-
1018:04	Serial number	Serial number of the EtherCAT slave; the low byte (bit 0-7) of the low word contains the year of production, the high byte (bit 8-15) of the low word contains the week of production, the high word (bit 16-31) is 0	UINT32	RO	-

Index 10F0* Backup parameter handling**

Index (hex)	Name	Meaning	Data type	Flags	Default
10F0:0	Backup parameter handling	Information for standardized loading and saving of backup entries	UINT8	RO	0x01 (1 _{dec})
10F0:01	Checksum	Checksum across all backup entries of the EtherCAT slave	UINT32	RO	-

***) since revision no. EL31xx-00xx-0016

Index 1800 AI TxPDO-Par Standard Ch.1

Index (hex)	Name	Meaning	Data type	Flags	Default
1800:0	AI TxPDO-Par Standard Ch.1	PDO parameter TxPDO 1	UINT8	RO	0x06 (6 _{dec})
1800:06	Exclude TxPDOs	Specifies the TxPDOs (index of TxPDO mapping objects) that must not be transferred together with TxPDO 1	OCTET-STRING[2]	RO	01 1A

Index 1801 AI TxPDO-Par Compact Ch.1

Index (hex)	Name	Meaning	Data type	Flags	Default
1801:0	AI TxPDO-Par Compact Ch.1	PDO parameter TxPDO 2	UINT8	RO	0x06 (6 _{dec})
1801:06	Exclude TxPDOs	Specifies the TxPDOs (index of TxPDO mapping objects) that must not be transferred together with TxPDO 2	OCTET-STRING[2]	RO	00 1A

Index 1802 AI TxPDO-Par Standard Ch.2

Index (hex)	Name	Meaning	Data type	Flags	Default
1802:0	AI TxPDO-Par Standard Ch.2	PDO parameter TxPDO 3	UINT8	RO	0x06 (6 _{dec})
1802:06	Exclude TxPDOs	Specifies the TxPDOs (index of TxPDO mapping objects) that must not be transferred together with TxPDO 3	OCTET-STRING[2]	RO	03 1A

Index 1803 AI TxPDO-Par Compact Ch. 2

Index (hex)	Name	Meaning	Data type	Flags	Default
1803:0	AI TxPDO-Par Compact Ch.2	PDO parameter TxPDO 4	UINT8	RO	0x06 (6 _{dec})
1803:06	Exclude TxPDOs	Specifies the TxPDOs (index of TxPDO mapping objects) that must not be transferred together with TxPDO 4	OCTET-STRING[2]	RO	02 1A

Index 1804 AI TxPDO-Par Standard Ch.3

Index (hex)	Name	Meaning	Data type	Flags	Default
1804:0	AI TxPDO-Par Standard Ch.3	PDO parameter TxPDO 5	UINT8	RO	0x06 (6 _{dec})
1804:06	Exclude TxPDOs	Specifies the TxPDOs (index of TxPDO mapping objects) that must not be transferred together with TxPDO 5	OCTET-STRING[2]	RO	05 1A

Index 1805 AI TxPDO-Par Compact Ch. 3

Index (hex)	Name	Meaning	Data type	Flags	Default
1805:0	AI TxPDO-Par Compact Ch.3	PDO parameter TxPDO 6	UINT8	RO	0x06 (6 _{dec})
1805:06	Exclude TxPDOs	Specifies the TxPDOs (index of TxPDO mapping objects) that must not be transferred together with TxPDO 6	OCTET-STRING[2]	RO	04 1A

Index 1806 AI TxPDO-Par Standard Ch.4

Index (hex)	Name	Meaning	Data type	Flags	Default
1806:0	AI TxPDO-Par Standard Ch.4	PDO parameter TxPDO 7	UINT8	RO	0x06 (6 _{dec})
1806:06	Exclude TxPDOs	Specifies the TxPDOs (index of TxPDO mapping objects) that must not be transferred together with TxPDO 7	OCTET-STRING[2]	RO	07 1A

Index 1807 AI TxPDO-Par Compact Ch. 4

Index (hex)	Name	Meaning	Data type	Flags	Default
1807:0	AI TxPDO-Par Compact Ch.4	PDO parameter TxPDO 8	UINT8	RO	0x06 (6 _{dec})
1807:06	Exclude TxPDOs	Specifies the TxPDOs (index of TxPDO mapping objects) that must not be transferred together with TxPDO 8	OCTET-STRING[2]	RO	06 1A

Index 1A00 AI TxPDO-Map Standard Ch.1

Index (hex)	Name	Meaning	Data type	Flags	Default
1A00:0	AI TxPDO-Map Standard Ch.1	PDO Mapping TxPDO	UINT8	RO	0x0B (11 _{dec})
1A00:01	SubIndex 001	1. PDO Mapping entry (object 0x6000 (AI Inputs), entry 0x01 (Underrange))	UINT32	RO	0x6000:01, 1
1A00:02	SubIndex 002	2. PDO Mapping entry (object 0x6000 (AI Inputs), entry 0x02 (Ovrrange))	UINT32	RO	0x6000:02, 1
1A00:03	SubIndex 003	3. PDO Mapping entry (object 0x6000 (AI Inputs), entry 0x03 (Limit 1))	UINT32	RO	0x6000:03, 2
1A00:04	SubIndex 004	4. PDO Mapping entry (object 0x6000 (AI Inputs), entry 0x05 (Limit 2))	UINT32	RO	0x6000:05, 2
1A00:05	SubIndex 005	5. PDO Mapping entry (object 0x6000 (AI Inputs), entry 0x07 (Error))	UINT32	RO	0x6000:07, 1
1A00:06	SubIndex 006	6. PDO Mapping entry (1 bit align)	UINT32	RO	0x0000:00, 1
1A00:07	SubIndex 007	7. PDO Mapping entry (5 bits align)	UINT32	RO	0x0000:00, 5
1A00:08	SubIndex 008	8. PDO Mapping entry (object 0x6000 (AI Inputs), entry 0x0E (Sync Error))	UINT32	RO	0x6000:0E, 1
1A00:09	SubIndex 009	9. PDO Mapping entry (object 0x6000 (AI Inputs), entry 0x0F (TxPDO State))	UINT32	RO	0x6000:0F, 1
1A00:0A	SubIndex 010	10. PDO Mapping entry (object 0x6000 (AI Inputs), entry 0x10 (TxPDO Toggle))	UINT32	RO	0x6000:10, 1
1A00:0B	SubIndex 011	11. PDO Mapping entry (object 0x6000 (AI Inputs), entry 0x11 (Value))	UINT32	RO	0x6000:11, 16

Index 1A01 AI TxPDO-Map Compact Ch.1

Index (hex)	Name	Meaning	Data type	Flags	Default
1A01:0	AI TxPDO-Map Compact Ch.1	PDO Mapping TxPDO 2	UINT8	RO	0x01 (1 _{dec})
1A01:01	SubIndex 001	1. PDO Mapping entry (object 0x6000 (AI Inputs), entry 0x11 (Value))	UINT32	RO	0x6000:11, 16

Index 1A02 AI TxPDO-Map Standard Ch.

Index (hex)	Name	Meaning	Data type	Flags	Default
1A02:0	AI TxPDO-Map Standard Ch.2	PDO Mapping TxPDO	UINT8	RO	0x0B (11 _{dec})
1A02:01	SubIndex 001	1. PDO Mapping entry (object 0x6010 (AI Inputs), entry 0x01 (Underrange))	UINT32	RO	0x6010:01, 1
1A02:02	SubIndex 002	2. PDO Mapping entry (object 0x6010 (AI Inputs), entry 0x02 (Overrange))	UINT32	RO	0x6010:02, 1
1A02:03	SubIndex 003	3. PDO Mapping entry (object 0x6010 (AI Inputs), entry 0x03 (Limit 1))	UINT32	RO	0x6010:03, 2
1A02:04	SubIndex 004	4. PDO Mapping entry (object 0x6010 (AI Inputs), entry 0x05 (Limit 2))	UINT32	RO	0x6010:05, 2
1A02:05	SubIndex 005	5. PDO Mapping entry (object 0x6010 (AI Inputs), entry 0x07 (Error))	UINT32	RO	0x6010:07, 1
1A02:06	SubIndex 006	6. PDO Mapping entry (1 bit align)	UINT32	RO	0x0000:00, 1
1A02:07	SubIndex 007	7. PDO Mapping entry (5 bits align)	UINT32	RO	0x0000:00, 5
1A02:08	SubIndex 008	8. PDO Mapping entry (object 0x6010 (AI Inputs), entry 0x0E (Sync Error))	UINT32	RO	0x6010:0E, 1
1A02:09	SubIndex 009	9. PDO Mapping entry (object 0x6010 (AI Inputs), entry 0x0F (TxPDO State))	UINT32	RO	0x6010:0F, 1
1A02:0A	SubIndex 010	10. PDO Mapping entry (object 0x6010 (AI Inputs), entry 0x10 (TxPDO Toggle))	UINT32	RO	0x6010:10, 1
1A02:0B	SubIndex 011	11. PDO Mapping entry (object 0x6010 (AI Inputs), entry 0x11 (Value))	UINT32	RO	0x6010:11, 16

Index 1A03 AI TxPDO-Map Compact Ch.2

Index (hex)	Name	Meaning	Data type	Flags	Default
1A03:0	AI TxPDO-Map Compact Ch.2	PDO Mapping TxPDO 4	UINT8	RO	0x01 (1 _{dec})
1A03:01	SubIndex 001	1. PDO Mapping entry (object 0x6010 (AI Inputs), entry 0x11 (Value))	UINT32	RO	0x6010:11, 16

Index 1A04 AI TxPDO-Map Standard Ch.3

Index (hex)	Name	Meaning	Data type	Flags	Default
1A04:0	AI TxPDO-Map Standard Ch.3	PDO Mapping TxPDO	UINT8	RO	0x0B (11 _{dec})
1A04:01	SubIndex 001	1. PDO Mapping entry (object 0x6020 (AI Inputs), entry 0x01 (Underrange))	UINT32	RO	0x6020:01, 1
1A04:02	SubIndex 002	2. PDO Mapping entry (object 0x6020 (AI Inputs), entry 0x02 (Overrange))	UINT32	RO	0x6020:02, 1
1A04:03	SubIndex 003	3. PDO Mapping entry (object 0x6020 (AI Inputs), entry 0x03 (Limit 1))	UINT32	RO	0x6020:03, 2
1A04:04	SubIndex 004	4. PDO Mapping entry (object 0x6020 (AI Inputs), entry 0x05 (Limit 2))	UINT32	RO	0x6020:05, 2
1A04:05	SubIndex 005	5. PDO Mapping entry (object 0x6020 (AI Inputs), entry 0x07 (Error))	UINT32	RO	0x6020:07, 1
1A04:06	SubIndex 006	6. PDO Mapping entry (1 bit align)	UINT32	RO	0x0000:00, 1
1A04:07	SubIndex 007	7. PDO Mapping entry (5 bits align)	UINT32	RO	0x0000:00, 5
1A04:08	SubIndex 008	8. PDO Mapping entry (object 0x6020 (AI Inputs), entry 0x0E (Sync Error))	UINT32	RO	0x6020:0E, 1
1A04:09	SubIndex 009	9. PDO Mapping entry (object 0x6020 (AI Inputs), entry 0x0F (TxPDO State))	UINT32	RO	0x6020:0F, 1
1A04:0A	SubIndex 010	10. PDO Mapping entry (object 0x6020 (AI Inputs), entry 0x10 (TxPDO Toggle))	UINT32	RO	0x6020:10, 1
1A04:0B	SubIndex 011	11. PDO Mapping entry (object 0x6020 (AI Inputs), entry 0x11 (Value))	UINT32	RO	0x6020:11, 16

Index 1A05 AI TxPDO-Map Compact Ch.3

Index (hex)	Name	Meaning	Data type	Flags	Default
1A05:0	AI TxPDO-Map Compact Ch.3	PDO Mapping TxPDO 6	UINT8	RO	0x01 (1 _{dec})
1A05:01	SubIndex 001	1. PDO Mapping entry (object 0x6020 (AI Inputs), entry 0x11 (Value))	UINT32	RO	0x6020:11, 16

Index 1A06 AI TxPDO-Map Standard Ch.4

Index (hex)	Name	Meaning	Data type	Flags	Default
1A06:0	AI TxPDO-Map Standard Ch.4	PDO Mapping TxPDO	UINT8	RO	0x0B (11 _{dec})
1A06:01	SubIndex 001	1. PDO Mapping entry (object 0x6030 (AI Inputs), entry 0x01 (Underrange))	UINT32	RO	0x6030:01, 1
1A06:02	SubIndex 002	2. PDO Mapping entry (object 0x6030 (AI Inputs), entry 0x02 (Overrange))	UINT32	RO	0x6030:02, 1
1A06:03	SubIndex 003	3. PDO Mapping entry (object 0x6030 (AI Inputs), entry 0x03 (Limit 1))	UINT32	RO	0x6030:03, 2
1A06:04	SubIndex 004	4. PDO Mapping entry (object 0x6030 (AI Inputs), entry 0x05 (Limit 2))	UINT32	RO	0x6030:05, 2
1A06:05	SubIndex 005	5. PDO Mapping entry (object 0x6030 (AI Inputs), entry 0x07 (Error))	UINT32	RO	0x6030:07, 1
1A06:06	SubIndex 006	6. PDO Mapping entry (1 bit align)	UINT32	RO	0x0000:00, 1
1A06:07	SubIndex 007	7. PDO Mapping entry (5 bits align)	UINT32	RO	0x0000:00, 5
1A06:08	SubIndex 008	8. PDO Mapping entry (object 0x6030 (AI Inputs), entry 0x0E (Sync Error))	UINT32	RO	0x6030:0E, 1
1A06:09	SubIndex 009	9. PDO Mapping entry (object 0x6030 (AI Inputs), entry 0x0F (TxPDO State))	UINT32	RO	0x6030:0F, 1
1A06:0A	SubIndex 010	10. PDO Mapping entry (object 0x6030 (AI Inputs), entry 0x10 (TxPDO Toggle))	UINT32	RO	0x6030:10, 1
1A06:0B	SubIndex 011	11. PDO Mapping entry (object 0x6030 (AI Inputs), entry 0x11 (Value))	UINT32	RO	0x6030:11, 16

Index 1A07 AI TxPDO-Map Compact Ch.4

Index (hex)	Name	Meaning	Data type	Flags	Default
1A07:0	AI TxPDO-Map Compact Ch.4	PDO Mapping TxPDO 8	UINT8	RO	0x01 (1 _{dec})
1A07:01	SubIndex 001	1. PDO Mapping entry (object 0x6030 (AI Inputs), entry 0x11 (Value))	UINT32	RO	0x6030:11, 16

Index 1C00 Sync manager type

Index (hex)	Name	Meaning	Data type	Flags	Default
1C00:0	Sync manager type	Using the sync managers	UINT8	RO	0x04 (4 _{dec})
1C00:01	SubIndex 001	Sync-Manager Type Channel 1: Mailbox Write	UINT8	RO	0x01 (1 _{dec})
1C00:02	SubIndex 002	Sync-Manager Type Channel 2: Mailbox Read	UINT8	RO	0x02 (2 _{dec})
1C00:03	SubIndex 003	Sync-Manager Type Channel 3: Process Data Write (Outputs)	UINT8	RO	0x03 (3 _{dec})
1C00:04	SubIndex 004	Sync-Manager Type Channel 4: Process Data Read (Inputs)	UINT8	RO	0x04 (4 _{dec})

Index 1C12 RxPDO assign

Index (hex)	Name	Meaning	Data type	Flags	Default
1C12:0	RxPDO assign	PDO Assign Outputs	UINT8	RW	0x00 (0 _{dec})

Index 1C13 TxPDO assign

For operation on masters other than TwinCAT it must be ensured that the channels are entered in the PDO assignment ("TxPDO assign", object 0x1C13) successively.

Index (hex)	Name	Meaning	Data type	Flags	Default
1C13:0	TxPDO assign	PDO Assign Inputs	UINT8	RW	0x04 (4 _{dec})
1C13:01	SubIndex 001	1. zugeordnete TxPDO (enthält den Index des zugehörigen TxPDO Mapping Objekts)	UINT16	RW	0x1A00 (6656 _{dec})
1C13:02	SubIndex 002	2. zugeordnete TxPDO (enthält den Index des zugehörigen TxPDO Mapping Objekts)	UINT16	RW	0x1A02 (6658 _{dec})
1C13:03	SubIndex 003	3. zugeordnete TxPDO (enthält den Index des zugehörigen TxPDO Mapping Objekts)	UINT16	RW	0x1A04 (6660 _{dec})
1C13:04	SubIndex 004	4. zugeordnete TxPDO (enthält den Index des zugehörigen TxPDO Mapping Objekts)	UINT16	RW	0x1A06 (6662 _{dec})

Index 1C33 SM input parameter

Index (hex)	Name	Meaning	Data type	Flags	Default
1C33:0	SM input parameter	Synchronization parameters for the inputs	UINT8	RO	0x20 (32 _{dec})
1C33:01	Sync mode	Current synchronization mode: <ul style="list-style-type: none"> • Bit 0 = 0: Free Run • Bit 0 = 1: Synchron with SM 2 Event • Bit 15 = 0: Standard • Bit 15 = 1: FastOp mode (CoE deactivated) 	UINT16	RW	0x0000 (0 _{dec})
1C33:02	Cycle time	Cycle time (in ns): <ul style="list-style-type: none"> • Free Run: Cycle time of the local timer • Synchronous with SM 2 event: Master cycle time • DC-Mode: SYNC0/SYNC1 Cycle Time 	UINT32	RW	0x000F4240 (1000000 _{dec})
1C33:03	Shift time	Time between SYNC0 event and reading of the inputs (in ns, only DC mode)	UINT32	RO	0x00000000 (0 _{dec})
1C33:04	Sync modes supported	Supported synchronization modes: <ul style="list-style-type: none"> • Bit 0: free run is supported • Bit 1: synchronous with SM 2 event is supported (outputs available) • Bit 1: synchronous with SM 3 event is supported (no outputs available) • Bit 2-3 = 01: DC mode is supported • Bit 4-5 = 01: input shift through local event (outputs available) • Bit 4-5 = 10: input shift with SYNC1 event (no outputs available) • Bit 14 = 1: dynamic times (measurement through writing of 0x1C33:08) 	UINT16	RO	0xC003 (49155 _{dec})
1C33:05	Minimum cycle time	Minimum cycle time (in ns)	UINT32	RO	0x0000FDE8 (65000 _{dec})
1C33:06	Calc and copy time	Time between reading of the inputs and availability of the inputs for the master (in ns, only DC mode)	UINT32	RO	0x00000000 (0 _{dec})
1C33:07	Minimum delay time		UINT32	RO	0x00000000 (0 _{dec})
1C33:08	Get cycle time	With this entry the real required process data provision time can be measured. <ul style="list-style-type: none"> • 0: Measurement of the local cycle time is stopped • 1: Measurement of the local cycle time is started <p>The entries 0x1C33:03, 0x1C33:06, 1C33:09 are updated with the maximum measured values. For a subsequent measurement the measured values are reset.</p>	UINT16	RW	0x0000 (0 _{dec})
1C33:09	Maximum delay time	Time between SYNC1 event and reading of the inputs (in ns, only DC mode)	UINT32	RO	0x00000000 (0 _{dec})
1C33:0B	SM event missed counter	Number of missed SM events in OPERATIONAL (DC mode only)	UINT16	RO	0x0000 (0 _{dec})
1C33:0C	Cycle exceeded counter	Number of occasions the cycle time was exceeded in OPERATIONAL (cycle was not completed in time or the next cycle began too early)	UINT16	RO	0x0000 (0 _{dec})
1C33:0D	Shift too short counter	Number of occasions that the interval between SYNC0 and SYNC1 event was too short (DC mode only)	UINT16	RO	0x0000 (0 _{dec})
1C33:20	Sync error	The synchronization was not correct in the last cycle (outputs were output too late; DC mode only)	BOOLEAN	RO	0x00 (0 _{dec})

Index F009*** Password protection

Index (hex)	Name	Meaning	Data type	Flags	Default
F009:0	Password protection	Password protection user calibration [► 259]	UINT32	RW	0x00000000 (0 _{dec})

***) for EL31xx, see [note](#) [► 259]

5.6.7 EL317x

5.6.7.1 EL3172

5.6.7.1.1 Restore object

Index 1011 Restore default parameters

Index (hex)	Name	Meaning	Data type	Flags	Default
1011:0	Restore default parameters [►_503]	Restore default parameters	UINT8	RO	0x01 (1 _{dec})
1011:01	SubIndex 001	If this object is set to “ 0x64616F6C ” in the set value dialog, all backup objects are reset to their delivery state.	UINT32	RW	0x00000000 (0 _{dec})

5.6.7.1.2 Configuration data

Index 80n0*** AI settings (for $0 \leq n \leq 1$)

Index (hex)	Name	Meaning	Data type	Flags	Default
80n0:0	AI Settings	Maximum subindex	UINT8	RO	0x18 (24 _{dec})
80n0:01	Enable user scale [▶ 269]	User scale is active.	BOOLEAN	RW	0x00 (0 _{dec})
80n0:02	Presentation [▶ 244]	0: Signed presentation 1: Unsigned presentation 2: Absolute value with MSB as sign Signed amount representation	BIT3	RW	0x00 (0 _{dec})
80n0:05	Siemens bits [▶ 246]	The S5 bits are displayed in the three low-order bits	BOOLEAN	RW	0x00 (0 _{dec})
80n0:06	Enable filter	Enable filter, which makes PLC-cycle-synchronous data exchange unnecessary	BOOLEAN	RW	0x00 (0 _{dec})
80n0:07	Enable limit 1 [▶ 246]	Limit 1 enabled	BOOLEAN	RW	0x00 (0 _{dec})
80n0:08	Enable limit 2 [▶ 246]	Limit 2 enabled	BOOLEAN	RW	0x00 (0 _{dec})
80n0:0A	Enable user calibration [▶ 269]	Enabling of the user calibration	BOOLEAN	RW	0x00 (0 _{dec})
80n0:0B	Enable vendor calibration [▶ 269]	Enabling of the vendor calibration	BOOLEAN	RW	0x01 (1 _{dec})
80n0:0E	Swap limit bits [▶ 247]	Changing of the Limit Bits	BOOLEAN	RW	0x00 (0 _{dec})
80n0:11	User scale offset [▶ 269]	User scaling offset	INT16	RW	0x0000 (0 _{dec})
80n0:12	User scale gain [▶ 269]	User scaling gain. The gain is represented in fixed-point format, with the factor 2^{-16} . The value 1 corresponds to 65536 _{dec} (0x00010000) and is limited to $\pm 0x7FFFF$	INT32	RW	0x00010000 (65536 _{dec})
80n0:13	Limit 1 [▶ 246]	First limit value for setting the status bits	INT16	RW	0x0000 (0 _{dec})
80n0:14	Limit 2 [▶ 246]	Second limit value for setting the status bits	INT16	RW	0x0000 (0 _{dec})
80n0:15	Filter settings	This object determines the digital filter settings, if it is active via Enable filter (index 0x80n0:06 [▶ 458]). The possible settings are sequentially numbered. 0: 50 Hz FIR 1: 60 Hz FIR 2: IIR 1 3: IIR 2 4: IIR 3 5: IIR 4 6: IIR 5 7: IIR 6 8: IIR 7 9: IIR 8	UINT16	RW	0x0000 (0 _{dec})
80n0:17	User calibration offset [▶ 269]	User offset compensation	INT16	RW	0x0000 (0 _{dec})
80n0:18	User calibration gain [▶ 269]	User calibration gain	INT16	RW	0x4000 (16384 _{dec})

***) since revision no. EL31xx-00xx-0016



The filter characteristics are set via index [0x8000:15](#) [\[▶ 458\]](#)

The filter frequencies are set for all channels of the EL31xx terminals centrally via index [0x8000:15](#) [\[▶ 458\]](#) (channel 1). All other corresponding indices 0x80n0:15 have no parameterization function!

Index 80nD AI Advanced settings (for 0 ≤ n ≤ 1)

Index (hex)	Name	Meaning	Data type	Flags	Default	
80nD:0	AI Advanced Settings	Maximum subindex	UINT8	RO	0x12 (18 _{dez})	
80nD:11	Input Type	Measurement mode, allowed values:	UINT16	RW	0x0002 (2 _{dez})	
		0x02				-10..+10 V)
		0x0E				0..10 V
		0x11				-20..+20 mA
		0x12				0..20 mA
		0x13				4..20 mA
80nD:12	Scaler	Scaling range, allowed values:	UINT16	RW	0x0000 (0 _{dez})	
		0x00				Extended Range
		0x03				0x03 Legacy Range
80nD:17	Low Range Error	Lower threshold for setting the error bit and error led	INT32	RW	Dependent on 80nD:11	
80nD:18	High Range Error	Upper threshold for setting the error bit and error led	INT32	RW	Dependent on 80nD:11	

5.6.7.1.3 Profile-specific objects (0x6000-0xFFFF)

The profile-specific objects have the same meaning for all EtherCAT slaves that support the profile 5001.

5.6.7.1.3.1 Input data

Index 60n0* AI inputs (for 0 ≤ n ≤ 1)**

Index (hex)	Name	Meaning	Data type	Flags	Default
60n0:0	AI inputs	Maximum subindex	INT16	RO	0x11 (17 _{dec})
60n0:01	Underrange	Value below measuring range.	BOOLEAN	RO	0x00 (0 _{dec})
60n0:02	Overrange	Measuring range exceeded.	BOOLEAN	RO	0x00 (0 _{dec})
60n0:03	Limit 1	Limit value monitoring Limit 1	BIT2	RO	0x00 (0 _{dec})
		0: not active			
		1: value is smaller than limit value 1			
		2: value is larger than limit value 1			
60n0:05	Limit 2	Limit value monitoring limit 2	BIT2	RO	0x00 (0 _{dec})
		0: not active			
		1: value is smaller than limit value 2			
		2: value is larger than limit value 2			
60n0:07	Error	The error bit is set if the data is invalid (over-range, under-range)	BOOLEAN	RO	0x00 (0 _{dec})
60n0:0E	Sync error	The Sync error bit is only required for DC mode. It indicates whether a synchronization error has occurred during the previous cycle.	BOOLEAN	RO	0x00 (0 _{dec})
		This means a SYNC signal was triggered in the EL31xx, although no new process data were available (0=OK, 1=NOK).			
60n0:0F	TxPDO State	Validity of the data of the associated TxPDO (0 = valid, 1 = invalid).	BOOLEAN	RO	0x00 (0 _{dec})
60n0:10	TxPDO Toggle	The TxPDO toggle is toggled by the slave when the data of the associated TxPDO is updated.	BOOLEAN	RO	0x00 (0 _{dec})
60n0:11	Value	Analog input date	INT16	RO	0x0000 (0 _{dec})

***) since revision no. EL31xx-00xx-0016

5.6.7.1.3.2 Configuration data (vendor-specific)

Index 80nF AI Vendor data (for $0 \leq n \leq 1$)

Index (hex)	Name	Meaning	Data type	Flags	Default
80nF:0	AI Vendor data	AI Vendor data	UINT8	RO	0x06 (6 _{dec})
80nF:01	R0 Offset	Offset (vendor calibration)	INT16	RW	0x0000 (0 _{dec})
80nF:02	R0 Gain	Gain (vendor calibration)	INT16	RW	0x4000 (16384 _{dec})
80nF:03	R1 Offset	Offset (vendor calibration)	INT16	RW	0x0000 (0 _{dec})
80nF:04	R1 Gain	Gain (vendor calibration)	INT16	RW	0x4000 (16384 _{dec})
80nF:05	R2 Offset	Offset (vendor calibration)	INT16	RW	0x0000 (0 _{dec})
80nF:06	R2 Gain	Gain (vendor calibration)	INT16	RW	0x4000 (16384 _{dec})

5.6.7.1.3.3 Information and diagnostic data

Index 80nE*** AI internal data (for $0 \leq n \leq 1$)

Index (hex)	Name	Meaning	Data type	Flags	Default
80nE:0	AI internal data	Maximum subindex	UINT8	RO	0x01 (1 _{dec})
80nE:01	ADC raw value	ADC raw value	UINT16	RO	-

***) since revision no. EL31xx-00xx-0016

Index F000*** Modular device profile

Index (hex)	Name	Meaning	Data type	Flags	Default
F000:0	Modular device profile	General information for the modular device profile	UINT8	RO	0x02 (2 _{dec})
F000:01	Module index distance	Index spacing of the objects of the individual channels	UINT16	RO	0x0010 (16 _{dec})
F000:02	Maximum number of modules	Number of channels	UINT16	RO	Max. Channels number of the terminal

***) since revision no. EL31xx-00xx-0016

Index F008*** Code word

Index	Name	Meaning	Data type	Flags	Default
F008:0	Code word	reserved	UINT32	RW	0x00000000 (0 _{dec})

***) since revision no. EL31xx-00xx-0016

Index F010*** module list (for $1 \leq n \leq 4$, depends on number of channels)

Index (hex)	Name	Meaning	Data type	Flags	Default
F010:0	Module list	Maximum subindex	UINT8	RW	0x0n
F010:0n	SubIndex 00n	Analog input profile (300)	UINT32	RW	0x0000012C (300 _{dec})

***) since revision no. EL31xx-00xx-0016

5.6.7.1.4 Standard objects

Standard objects (0x1000-0x1FFF)

The standard objects have the same meaning for all EtherCAT slaves.

Index 1000 Device type

Index (hex)	Name	Meaning	Data type	Flags	Default
1000:0	Device type	Device type of the EtherCAT slave: the Lo-Word contains the CoE profile used (5001). The Hi-Word contains the module profile according to the modular device profile.	UINT32	RO	0x012C1389 (19665801 _{dec})

Index 1008 Device name

Index (hex)	Name	Meaning	Data type	Flags	Default
1008:0	Device name	Device name of the EtherCAT slave	STRING	RO	EL31xx

Index 1009 Hardware version

Index (hex)	Name	Meaning	Data type	Flags	Default
1009:0	Hardware version	Hardware version of the EtherCAT slave	STRING	RO	00

Index 100A Software version

Index (hex)	Name	Meaning	Data type	Flags	Default
100A:0	Software version	Firmware version of the EtherCAT slave	STRING	RO	-

Index 1018 Identity

Index (hex)	Name	Meaning	Data type	Flags	Default
1018:0	Identity	Information for identifying the slave	UINT8	RO	0x04 (4 _{dec})
1018:01	Vendor ID	Vendor ID of the EtherCAT slave	UINT32	RO	0x00000002 (2 _{dec})
1018:02	Product code	Product code of the EtherCAT slave	UINT32	RO	0xFFFFX3052
1018:03	Revision	Revision number of the EtherCAT slave; the low word (bit 0-15) indicates the special terminal number, the high word (bit 16-31) refers to the device description	UINT32	RO	-
1018:04	Serial number	Serial number of the EtherCAT slave; the low byte (bit 0-7) of the low word contains the year of production, the high byte (bit 8-15) of the low word contains the week of production, the high word (bit 16-31) is 0	UINT32	RO	-

Index 10E2 Manufacturer-specific Identification Code¹⁾

Index (hex)	Name	Meaning	Data type	Flags	Default
10E2:0	Manufacturer-specific identification code	Manufacturer specific identification code	UINT8	RO	0x01 (1 _{dec})
10E2:01	Subindex 001		STRING	RO	

Index 10F0* Backup parameter handling**

Index (hex)	Name	Meaning	Data type	Flags	Default
10F0:0	Backup parameter handling	Information for standardized loading and saving of backup entries	UINT8	RO	0x01 (1 _{dec})
10F0:01	Checksum	Checksum across all backup entries of the EtherCAT slave	UINT32	RO	-

***) since revision no. EL31xx-00xx-0016

Index 180n* (AI) TxPDO-Par (for $0 \leq n \leq 7$, depends on number of channels)**

Index (hex)	Name	Meaning	Data type	Flags	Default
180n:0	AI TxPDO-Par Standard	PDO Parameter TxPDO	UINT8	RO	0x06 (6 _{dez})
180n:06	Exclude TxPDOs	Specifies the TxPDOs (index of TxPDO mapping objects) that must not be transferred together with this PDO	OCTET-STRING[2]	RO	n= Wert: 0 0x011A 1 0x001A 2 0x031A 3 0x021A 4 0x051A 5 0x041A 6 0x071A 7 0x061A

***) since revision no. EL31xx-00xx-0016

Index 1A0n AI TxPDO-Map Standard (for $n = 0, 2 p = 0, 1$)

Index (hex)	Name	Meaning	Data type	Flags	Default
1A0n:0	AI TxPDO-Map standard	PDO Mapping TxPDO	UINT8	RO	0x0B (11 _{dec})
1A0n:01	SubIndex 001	1. PDO Mapping entry (object 0x60p0 (AI Inputs), entry 0x01 (Underrange))	UINT32	RO	0x60p0:01, 1
1A0n:02	SubIndex 002	2. PDO Mapping entry (object 0x60p0 (AI Inputs), entry 0x02 (Overrange))	UINT32	RO	0x60p0:02, 1
1A0n:03	SubIndex 003	3. PDO Mapping entry (object 0x60p0 (AI Inputs), entry 0x03 (Limit 1))	UINT32	RO	0x60p0:03, 2
1A0n:04	SubIndex 004	4. PDO Mapping entry (object 0x60p0 (AI Inputs), entry 0x05 (Limit 2))	UINT32	RO	0x60p0:05, 2
1A0n:05	SubIndex 005	5. PDO Mapping entry (object 0x60p0 (AI Inputs), entry 0x07 (Error))	UINT32	RO	0x60p0:07, 2
1A0n:06	SubIndex 006	6. PDO Mapping entry (1 bit align)	UINT32	RO	0x0000:00, 1
1A0n:07	SubIndex 007	7. PDO Mapping entry (5 bits align)	UINT32	RO	0x0000:00, 5
1A0n:08	SubIndex 008	8. PDO Mapping entry (object 0x1C32 (SM input parameter), entry 0x20 (Sync error))	UINT32	RO	0x1C32:20, 1
1A0n:09	SubIndex 009	9. PDO Mapping entry (object 0x180n (AI TxPDO-Par standard), entry 0x07 (TxPDO State))	UINT32	RO	0x180n:07, 1
1A0n:0A	SubIndex 010	10. PDO Mapping entry (object 0x180n (AI TxPDO-Par standard), entry 0x09 (TxPDO Toggle))	UINT32	RO	0x180n:09, 1
1A0n:0B	SubIndex 011	11. PDO Mapping entry (object 0x60p0 (AI Inputs), entry 0x11 (Value))	UINT32	RO	0x60p0:11, 16

***) since revision no. EL31xx-00xx-0016

Index 1A0n AI TxPDO-Map Compact (for $n = 1, 3; p = 0, 1$)

Index (hex)	Name	Meaning	Data type	Flags	Default
1A0n:0	AI TxPDO-Map Compact	PDO Mapping TxPDO	UINT8	RO	0x01 (1 _{dec})
1A0n:01	SubIndex 001	1. PDO Mapping entry (object 0x60p0 (AI Inputs), entry 0x11 (Value))	UINT32	RO	0x60p0:11, 16

Index 1C00 Sync manager type

Index (hex)	Name	Meaning	Data type	Flags	Default
1C00:0	Sync manager type	Using the sync managers	UINT8	RO	0x04 (4 _{dec})
1C00:01	SubIndex 001	Sync-Manager Type Channel 1: Mailbox Write	UINT8	RO	0x01 (1 _{dec})
1C00:02	SubIndex 002	Sync-Manager Type Channel 2: Mailbox Read	UINT8	RO	0x02 (2 _{dec})
1C00:03	SubIndex 003	Sync-Manager Type Channel 3: Process Data Write (Outputs)	UINT8	RO	0x03 (3 _{dec})
1C00:04	SubIndex 004	Sync-Manager Type Channel 4: Process Data Read (Inputs)	UINT8	RO	0x04 (4 _{dec})

Index 1C12 RxPDO assign

Index (hex)	Name	Meaning	Data type	Flags	Default
1C12:0	RxPDO assign	PDO Assign Outputs	UINT8	RW	0x00 (0 _{dec})

Index 1C13 TxPDO assign

For operation on masters other than TwinCAT it must be ensured that the channels are entered in the PDO assignment ("TxPDO assign", object 0x1C13) successively.

Index (hex)	Name	Meaning	Data type	Flags	Default
1C13:0	TxPDO assign	PDO Assign Inputs	UINT8	RW	0x02 (2 _{dec})
1C13:01	SubIndex 001	1. allocated TxPDO (contains the index of the associated TxPDO mapping object)	UINT16	RW	0x1A00 (6656 _{dec})
1C13:02	SubIndex 002	2. allocated TxPDO (contains the index of the associated TxPDO mapping object)	UINT16	RW	0x1A02 (6658 _{dec})

Index 1C33 SM input parameter

Index (hex)	Name	Meaning	Data type	Flags	Default
1C33:0	SM input parameter	Synchronization parameters for the inputs	UINT8	RO	0x20 (32 _{dec})
1C33:01	Sync mode	Current synchronization mode: <ul style="list-style-type: none"> Bit 0 = 0: Free Run Bit 0 = 1: Synchron with SM 2 Event Bit 15 = 0: Standard Bit 15 = 1: FastOp mode (CoE deactivated) 	UINT16	RW	0x0000 (0 _{dec})
1C33:02	Cycle time	Cycle time (in ns): <ul style="list-style-type: none"> Free Run: Cycle time of the local timer Synchronous with SM 2 event: Master cycle time DC-Mode: SYNC0/SYNC1 Cycle Time 	UINT32	RW	0x000F4240 (1000000 _{dec})
1C33:03	Shift time	Time between SYNC0 event and reading of the inputs (in ns, only DC mode)	UINT32	RO	0x00000000 (0 _{dec})
1C33:04	Sync modes supported	Supported synchronization modes: <ul style="list-style-type: none"> Bit 0: free run is supported Bit 1: synchronous with SM 2 event is supported (outputs available) Bit 1: synchronous with SM 3 event is supported (no outputs available) Bit 2-3 = 01: DC mode is supported Bit 4-5 = 01: input shift through local event (outputs available) Bit 4-5 = 10: input shift with SYNC1 event (no outputs available) Bit 14 = 1: dynamic times (measurement through writing of 0x1C33:08) 	UINT16	RO	0xC003 (49155 _{dec})
1C33:05	Minimum cycle time	Minimum cycle time (in ns)	UINT32	RO	0x0000FDE8 (65000 _{dec})
1C33:06	Calc and copy time	Time between reading of the inputs and availability of the inputs for the master (in ns, only DC mode)	UINT32	RO	0x00000000 (0 _{dec})
1C33:07	Minimum delay time		UINT32	RO	0x00000000 (0 _{dec})
1C33:08	Get cycle time	With this entry the real required process data provision time can be measured. <ul style="list-style-type: none"> 0: Measurement of the local cycle time is stopped 1: Measurement of the local cycle time is started The entries 0x1C33:03, 0x1C33:06, 1C33:09 are updated with the maximum measured values. For a subsequent measurement the measured values are reset.	UINT16	RW	0x0000 (0 _{dec})
1C33:09	Maximum delay time	Time between SYNC1 event and reading of the inputs (in ns, only DC mode)	UINT32	RO	0x00000000 (0 _{dec})
1C33:0B	SM event missed counter	Number of missed SM events in OPERATIONAL (DC mode only)	UINT16	RO	0x0000 (0 _{dec})
1C33:0C	Cycle exceeded counter	Number of occasions the cycle time was exceeded in OPERATIONAL (cycle was not completed in time or the next cycle began too early)	UINT16	RO	0x0000 (0 _{dec})
1C33:0D	Shift too short counter	Number of occasions that the interval between SYNC0 and SYNC1 event was too short (DC mode only)	UINT16	RO	0x0000 (0 _{dec})
1C33:20	Sync error	The synchronization was not correct in the last cycle (outputs were output too late; DC mode only)	BOOLEAN	RO	0x00 (0 _{dec})

Index F009*** Password protection

Index (hex)	Name	Meaning	Data type	Flags	Default
F009:0	Password protection	Password protection user calibration [► 259]	UINT32	RW	0x00000000 (0 _{dec})

***) for EL31xx, see [note](#) [► 259]

5.6.7.2 EL3174

5.6.7.2.1 Restore object

Index 1011 Restore default parameters

Index (hex)	Name	Meaning	Data type	Flags	Default
1011:0	Restore default parameters [▶ 503]	Restore default parameters	UINT8	RO	0x01 (1 _{dec})
1011:01	SubIndex 001	If this object is set to “0x64616F6C” in the set value dialog, all backup objects are reset to their delivery state.	UINT32	RW	0x00000000 (0 _{dec})

5.6.7.2.2 Configuration data

Index 80n0*** AI settings (for 0 ≤ n ≤ 3)

Index (hex)	Name	Meaning	Data type	Flags	Default
80n0:0	AI Settings	Maximum subindex	UINT8	RO	0x18 (24 _{dec})
80n0:01	Enable user scale [▶ 269]	User scale is active.	BOOLEAN	RW	0x00 (0 _{dec})
80n0:02	Presentation [▶ 244]	0: Signed presentation 1: Unsigned presentation 2: Absolute value with MSB as sign Signed amount representation	BIT3	RW	0x00 (0 _{dec})
80n0:05	Siemens bits [▶ 246]	The S5 bits are displayed in the three low-order bits	BOOLEAN	RW	0x00 (0 _{dec})
80n0:06	Enable filter	Enable filter, which makes PLC-cycle-synchronous data exchange unnecessary	BOOLEAN	RW	0x00 (0 _{dec})
80n0:07	Enable limit 1 [▶ 246]	Limit 1 enabled	BOOLEAN	RW	0x00 (0 _{dec})
80n0:08	Enable limit 2 [▶ 246]	Limit 2 enabled	BOOLEAN	RW	0x00 (0 _{dec})
80n0:0A	Enable user calibration [▶ 269]	Enabling of the user calibration	BOOLEAN	RW	0x00 (0 _{dec})
80n0:0B	Enable vendor calibration [▶ 269]	Enabling of the vendor calibration	BOOLEAN	RW	0x01 (1 _{dec})
80n0:0E	Swap limit bits [▶ 247]	Changing of the Limit Bits	BOOLEAN	RW	0x00 (0 _{dec})
80n0:11	User scale offset [▶ 269]	User scaling offset	INT16	RW	0x0000 (0 _{dec})
80n0:12	User scale gain [▶ 269]	User scaling gain. The gain is represented in fixed-point format, with the factor 2 ⁻¹⁶ . The value 1 corresponds to 65536 _{dec} (0x00010000) and is limited to ±0x7FFFF	INT32	RW	0x00010000 (65536 _{dec})
80n0:13	Limit 1 [▶ 246]	First limit value for setting the status bits	INT16	RW	0x0000 (0 _{dec})
80n0:14	Limit 2 [▶ 246]	Second limit value for setting the status bits	INT16	RW	0x0000 (0 _{dec})
80n0:15	Filter settings	This object determines the digital filter settings, if it is active via Enable filter (index 0x80n0:06 [▶ 465]). The possible settings are sequentially numbered. 0: 50 Hz FIR 1: 60 Hz FIR 2: IIR 1 3: IIR 2 4: IIR 3 5: IIR 4 6: IIR 5 7: IIR 6 8: IIR 7 9: IIR 8	UINT16	RW	0x0000 (0 _{dec})
80n0:17	User calibration offset [▶ 269]	User offset compensation	INT16	RW	0x0000 (0 _{dec})
80n0:18	User calibration gain [▶ 269]	User calibration gain	INT16	RW	0x4000 (16384 _{dec})

***) since revision no. EL31xx-00xx-0016

Filter

The filters of the EL30xx/EL31xx are activated or deactivated via the CoE index 0x8000:15.

i The filter characteristics are set via index 0x8000:15

The filter frequencies are set for all channels of the EL30xx/EL31xx terminals centrally via index 0x8000:15 (channel 1). All other corresponding indices 0x80n0:15 have no parameterization function! The latest firmware version (see [status table](#) [▶ 484]) returns an EtherCAT-compliant error message, if the filter characteristics of other channels (index 0x80n0:06, 0x80n0:15) are set.

Index 80nD AI Advanced settings (for $0 \leq n \leq 3$, only EL3174 and EL3174-00xx)

Index (hex)	Name	Meaning	Data type	Flags	Default	
80nD:0	AI Advanced Settings	Maximum subindex	UINT8	RO	0x12 (18 _{dec})	
80nD:11	Input Type	Measurement mode, allowed values:	UINT16	RW	0x0002 (2 _{dec})	
		0x01				±60 V (only EL3174-0042)
		0x02				±10 V (not EL3174-0032/0042) ±3 V (only EL3174-0032) ±30 V (only EL3174-0042)
		0x0D				0..60 V (only EL3174-0042)
		0x0E				0..10 V (not EL3174-0032/0042) 0..3 V (only EL3174-0032) 0..30 V (only EL3174-0042)
		0x11				±20 mA (not EL3174-0042)
		0x12				0..20 mA (not EL3174-0042)
		0x13				4.. 20 mA (not EL3174-0042)
80nD:12	Scaler	Scaling range, allowed values:	UINT16	RW	0x0000 (0 _{dec})	
		0x00				Extended Range
		0x03				0x03 Legacy Range
80nD:17	Low Range Error	Lower threshold for setting the error bit and error led	INT32	RW	Dependent on 80nD:11	
80nD:18	High Range Error	Upper threshold for setting the error bit and error led	INT32	RW	Dependent on 80nD:11	

5.6.7.2.3 Profile-specific objects (0x6000-0xFFFF)

The profile-specific objects have the same meaning for all EtherCAT slaves that support the profile 5001.

5.6.7.2.3.1 Input data

Index 60n0*** AI inputs (for $0 \leq n \leq 3$)

Index (hex)	Name	Meaning	Data type	Flags	Default
60n0:0	AI inputs	Maximum subindex	INT16	RO	0x11 (17 _{dec})
60n0:01	Underrange	Value below measuring range.	BOOLEAN	RO	0x00 (0 _{dec})
60n0:02	Overrange	Measuring range exceeded.	BOOLEAN	RO	0x00 (0 _{dec})
60n0:03	Limit 1	Limit value monitoring Limit 1 0: not active 1: value is smaller than limit value 1 2: value is larger than limit value 1 3: Value is equal to limit value 1	BIT2	RO	0x00 (0 _{dec})
60n0:05	Limit 2	Limit value monitoring limit 2 0: not active 1: value is smaller than limit value 2 2: value is larger than limit value 2 3: Value is equal to limit value 2	BIT2	RO	0x00 (0 _{dec})
60n0:07	Error	The error bit is set if the data is invalid (over-range, under-range)	BOOLEAN	RO	0x00 (0 _{dec})
60n0:0E	Sync error	The Sync error bit is only required for DC mode. It indicates whether a synchronization error has occurred during the previous cycle. This means a SYNC signal was triggered in the EL31xx, although no new process data were available (0=OK, 1=NOK).	BOOLEAN	RO	0x00 (0 _{dec})
60n0:0F	TxPDO State	Validity of the data of the associated TxPDO (0 = valid, 1 = invalid).	BOOLEAN	RO	0x00 (0 _{dec})
60n0:10	TxPDO Toggle	The TxPDO toggle is toggled by the slave when the data of the associated TxPDO is updated.	BOOLEAN	RO	0x00 (0 _{dec})
60n0:11	Value	Analog input date	INT16	RO	0x0000 (0 _{dec})

***) since revision no. EL31xx-00xx-0016

5.6.7.2.3.2 Configuration data (vendor-specific)

Index 80nF AI Vendor data (for $0 \leq n \leq 3$, only EL3174 and EL3174-00xx)

Index (hex)	Name	Meaning	Data type	Flags	Default
80nF:0	AI Vendor data	Maximum subindex	UINT8	RO	0x06 (6 _{dez})
80nF:01	R0 offset	Offset (Vendor calibration)	INT16	RW	0x0000 (0 _{dez})
80nF:02	R0 gain	Gain (Vendor calibration)	INT16	RW	0x4000 (16384 _{dez})
80nF:03	R1 offset	Offset (Vendor calibration)	INT16	RW	0x0000 (0 _{dez})
80nF:04	R1 gain	Gain (Vendor calibration)	INT16	RW	0x4000 (16384 _{dez})
80nF:05	R2 offset	Offset (Vendor calibration)	INT16	RW	0x0000 (0 _{dez})
80nF:06	R2 gain	Gain (Vendor calibration)	INT16	RW	0x4000 (16384 _{dez})

5.6.7.2.3.3 Information and diagnostic data

Index 80nE*** AI internal data (for $0 \leq n \leq 3$)

Index (hex)	Name	Meaning	Data type	Flags	Default
80nE:0	AI internal data	Maximum subindex	UINT8	RO	0x01 (1 _{dec})
80nE:01	ADC raw value	ADC raw value	UINT16	RO	-

***) since revision no. EL31xx-00xx-0016

Index F000* Modular device profile**

Index (hex)	Name	Meaning	Data type	Flags	Default
F000:0	Modular device profile	General information for the modular device profile	UINT8	RO	0x02 (2 _{dec})
F000:01	Module index distance	Index spacing of the objects of the individual channels	UINT16	RO	0x0010 (16 _{dec})
F000:02	Maximum number of modules	Number of channels	UINT16	RO	Max. Channels number of the terminal

***) since revision no. EL31xx-00xx-0016

Index F008* Code word**

Index	Name	Meaning	Data type	Flags	Default
F008:0	Code word	reserved	UINT32	RW	0x00000000 (0 _{dec})

***) since revision no. EL31xx-00xx-0016

Index F010* module list (for $1 \leq n \leq 4$, depends on number of channels)**

Index (hex)	Name	Meaning	Data type	Flags	Default
F010:0	Module list	Maximum subindex	UINT8	RW	0x0n
F010:0n	SubIndex 00n	Analog input profile (300)	UINT32	RW	0x0000012C (300 _{dec})

***) since revision no. EL31xx-00xx-0016

5.6.7.2.4 Standard objects**Standard objects (0x1000-0x1FFF)**

The standard objects have the same meaning for all EtherCAT slaves.

Index 1000 Device type

Index (hex)	Name	Meaning	Data type	Flags	Default
1000:0	Device type	Device type of the EtherCAT slave: the Lo-Word contains the CoE profile used (5001). The Hi-Word contains the module profile according to the modular device profile.	UINT32	RO	0x012C1389 (19665801 _{dec})

Index 1008 Device name

Index (hex)	Name	Meaning	Data type	Flags	Default
1008:0	Device name	Device name of the EtherCAT slave	STRING	RO	EL31xx

Index 1009 Hardware version

Index (hex)	Name	Meaning	Data type	Flags	Default
1009:0	Hardware version	Hardware version of the EtherCAT slave	STRING	RO	00

Index 100A Software version

Index (hex)	Name	Meaning	Data type	Flags	Default
100A:0	Software version	Firmware version of the EtherCAT slave	STRING	RO	-

Index 1018 Identity

Index (hex)	Name	Meaning	Data type	Flags	Default
1018:0	Identity	Information for identifying the slave	UINT8	RO	0x04 (4 _{dec})
1018:01	Vendor ID	Vendor ID of the EtherCAT slave	UINT32	RO	0x00000002 (2 _{dec})
1018:02	Product code	Product code of the EtherCAT slave	UINT32	RO	0xFFFF3052
1018:03	Revision	Revision number of the EtherCAT slave; the low word (bit 0-15) indicates the special terminal number, the high word (bit 16-31) refers to the device description	UINT32	RO	-
1018:04	Serial number	Serial number of the EtherCAT slave; the low byte (bit 0-7) of the low word contains the year of production, the high byte (bit 8-15) of the low word contains the week of production, the high word (bit 16-31) is 0	UINT32	RO	-

Index 10E2 Manufacturer-specific Identification Code¹⁾

Index (hex)	Name	Meaning	Data type	Flags	Default
10E2:0	Manufacturer-specific identification code	Manufacturer specific identification code	UINT8	RO	0x01 (1 _{dec})
10E2:01	Subindex 001		STRING	RO	

¹⁾ only EL3174-0042

Index 10F0* Backup parameter handling**

Index (hex)	Name	Meaning	Data type	Flags	Default
10F0:0	Backup parameter handling	Information for standardized loading and saving of backup entries	UINT8	RO	0x01 (1 _{dec})
10F0:01	Checksum	Checksum across all backup entries of the EtherCAT slave	UINT32	RO	-

***) since revision no. EL31xx-00xx-0016

Index 180n* (AI) TxPDO-Par (for 0 ≤ n ≤ 7, depends on number of channels)**

Index (hex)	Name	Meaning	Data type	Flags	Default																		
180n:0	AI TxPDO-Par Standard	PDO Parameter TxPDO	UINT8	RO	0x06 (6 _{dez})																		
180n:06	Exclude TxPDOs	Specifies the TxPDOs (index of TxPDO mapping objects) that must not be transferred together with this PDO	OCTET-STRING[2]	RO	<table border="1"> <thead> <tr> <th>n=</th> <th>Wert:</th> </tr> </thead> <tbody> <tr><td>0</td><td>0x011A</td></tr> <tr><td>1</td><td>0x001A</td></tr> <tr><td>2</td><td>0x031A</td></tr> <tr><td>3</td><td>0x021A</td></tr> <tr><td>4</td><td>0x051A</td></tr> <tr><td>5</td><td>0x041A</td></tr> <tr><td>6</td><td>0x071A</td></tr> <tr><td>7</td><td>0x061A</td></tr> </tbody> </table>	n=	Wert:	0	0x011A	1	0x001A	2	0x031A	3	0x021A	4	0x051A	5	0x041A	6	0x071A	7	0x061A
n=	Wert:																						
0	0x011A																						
1	0x001A																						
2	0x031A																						
3	0x021A																						
4	0x051A																						
5	0x041A																						
6	0x071A																						
7	0x061A																						

***) since revision no. EL31xx-00xx-0016

Index 1A0n AI TxPDO-Map Standard (for n = 0, 2, 4, 6; p = 0, 1, 2, 3; depending on the number of channels, *not applicable for EL31x2*)

Index (hex)	Name	Meaning	Data type	Flags	Default
1A0n:0	AI TxPDO-Map standard	PDO Mapping TxPDO	UINT8	RO	0x0B (11 _{dec})
1A0n:01	SubIndex 001	1. PDO Mapping entry (object 0x60p0 (AI Inputs), entry 0x01 (Underrange))	UINT32	RO	0x60p0:01, 1
1A0n:02	SubIndex 002	2. PDO Mapping entry (object 0x60p0 (AI Inputs), entry 0x02 (Overrange))	UINT32	RO	0x60p0:02, 1
1A0n:03	SubIndex 003	3. PDO Mapping entry (object 0x60p0 (AI Inputs), entry 0x03 (Limit 1))	UINT32	RO	0x60p0:03, 2
1A0n:04	SubIndex 004	4. PDO Mapping entry (object 0x60p0 (AI Inputs), entry 0x05 (Limit 2))	UINT32	RO	0x60p0:05, 2
1A0n:05	SubIndex 005	5. PDO Mapping entry (object 0x60p0 (AI Inputs), entry 0x07 (Error))	UINT32	RO	0x60p0:07, 2
1A0n:06	SubIndex 006	6. PDO Mapping entry (1 bit align)	UINT32	RO	0x0000:00, 1
1A0n:07	SubIndex 007	7. PDO Mapping entry (5 bits align)	UINT32	RO	0x0000:00, 5
1A0n:08	SubIndex 008	8. PDO Mapping entry (object 0x1C32 (SM input parameter), entry 0x20 (Sync error))	UINT32	RO	0x1C32:20, 1
1A0n:09	SubIndex 009	9. PDO Mapping entry (object 0x180n (AI TxPDO-Par standard), entry 0x07 (TxPDO State))	UINT32	RO	0x180n:07, 1
1A0n:0A	SubIndex 010	10. PDO Mapping entry (object 0x180n (AI TxPDO-Par standard), entry 0x09 (TxPDO Toggle))	UINT32	RO	0x180n:09, 1
1A0n:0B	SubIndex 011	11. PDO Mapping entry (object 0x60p0 (AI Inputs), entry 0x11 (Value))	UINT32	RO	0x60p0:11, 16

Index 1A0n AI TxPDO-Map Compact (for n = 1, 3, 5, 7; p = 0, 1, 2, 3; depending on the number of channels, *not applicable for EL31x2*)

Index (hex)	Name	Meaning	Data type	Flags	Default
1A0n:0	AI TxPDO-Map Compact	PDO Mapping TxPDO	UINT8	RO	0x01 (1 _{dec})
1A0n:01	SubIndex 001	1. PDO Mapping entry (object 0x60p0 (AI Inputs), entry 0x11 (Value))	UINT32	RO	0x60p0:11, 16

Index 1C00 Sync manager type

Index (hex)	Name	Meaning	Data type	Flags	Default
1C00:0	Sync manager type	Using the sync managers	UINT8	RO	0x04 (4 _{dec})
1C00:01	SubIndex 001	Sync-Manager Type Channel 1: Mailbox Write	UINT8	RO	0x01 (1 _{dec})
1C00:02	SubIndex 002	Sync-Manager Type Channel 2: Mailbox Read	UINT8	RO	0x02 (2 _{dec})
1C00:03	SubIndex 003	Sync-Manager Type Channel 3: Process Data Write (Outputs)	UINT8	RO	0x03 (3 _{dec})
1C00:04	SubIndex 004	Sync-Manager Type Channel 4: Process Data Read (Inputs)	UINT8	RO	0x04 (4 _{dec})

Index 1C12 RxPDO assign

Index (hex)	Name	Meaning	Data type	Flags	Default
1C12:0	RxPDO assign	PDO Assign Outputs	UINT8	RW	0x00 (0 _{dec})

Index 1C13 TxPDO assign (not applicable for EL31x2)

For operation on masters other than TwinCAT it must be ensured that the channels are entered in the PDO assignment ("TxPDO assign", object 0x1C13) successively.

Index (hex)	Name	Meaning	Data type	Flags	Default
1C13:0	TxPDO assign	PDO Assign Inputs	UINT8	RW	0x04 (4 _{dec})
1C13:01	SubIndex 001	1. allocated TxPDO (contains the index of the associated TxPDO mapping object)	UINT16	RW	0x1A00 (6656 _{dec})
1C13:02*	SubIndex 002	2. allocated TxPDO (contains the index of the associated TxPDO mapping object)	UINT16	RW	0x1A02 (6658 _{dec})
1C13:03*	SubIndex 003	3. allocated TxPDO (contains the index of the associated TxPDO mapping object)	UINT16	RW	0x1A04 (6660 _{dec})
1C13:04*	SubIndex 004	4. allocated TxPDO (contains the index of the associated TxPDO mapping object)	UINT16	RW	0x1A06 (6662 _{dec})

*) only for EL31x4

Index 1C33 SM input parameter

Index (hex)	Name	Meaning	Data type	Flags	Default
1C33:0	SM input parameter	Synchronization parameters for the inputs	UINT8	RO	0x20 (32 _{dec})
1C33:01	Sync mode	Current synchronization mode: <ul style="list-style-type: none"> Bit 0 = 0: Free Run Bit 0 = 1: Synchron with SM 2 Event Bit 15 = 0: Standard Bit 15 = 1: FastOp mode (CoE deactivated) 	UINT16	RW	0x0000 (0 _{dec})
1C33:02	Cycle time	Cycle time (in ns): <ul style="list-style-type: none"> Free Run: Cycle time of the local timer Synchronous with SM 2 event: Master cycle time DC-Mode: SYNC0/SYNC1 Cycle Time 	UINT32	RW	0x000F4240 (1000000 _{dec})
1C33:03	Shift time	Time between SYNC0 event and reading of the inputs (in ns, only DC mode)	UINT32	RO	0x00000000 (0 _{dec})
1C33:04	Sync modes supported	Supported synchronization modes: <ul style="list-style-type: none"> Bit 0: free run is supported Bit 1: synchronous with SM 2 event is supported (outputs available) Bit 1: synchronous with SM 3 event is supported (no outputs available) Bit 2-3 = 01: DC mode is supported Bit 4-5 = 01: input shift through local event (outputs available) Bit 4-5 = 10: input shift with SYNC1 event (no outputs available) Bit 14 = 1: dynamic times (measurement through writing of 0x1C33:08) 	UINT16	RO	0xC003 (49155 _{dec})
1C33:05	Minimum cycle time	Minimum cycle time (in ns)	UINT32	RO	0x0000FDE8 (65000 _{dec})
1C33:06	Calc and copy time	Time between reading of the inputs and availability of the inputs for the master (in ns, only DC mode)	UINT32	RO	0x00000000 (0 _{dec})
1C33:07	Minimum delay time		UINT32	RO	0x00000000 (0 _{dec})
1C33:08	Get cycle time	With this entry the real required process data provision time can be measured. <ul style="list-style-type: none"> 0: Measurement of the local cycle time is stopped 1: Measurement of the local cycle time is started The entries 0x1C33:03, 0x1C33:06, 1C33:09 are updated with the maximum measured values. For a subsequent measurement the measured values are reset.	UINT16	RW	0x0000 (0 _{dec})
1C33:09	Maximum delay time	Time between SYNC1 event and reading of the inputs (in ns, only DC mode)	UINT32	RO	0x00000000 (0 _{dec})
1C33:0B	SM event missed counter	Number of missed SM events in OPERATIONAL (DC mode only)	UINT16	RO	0x0000 (0 _{dec})
1C33:0C	Cycle exceeded counter	Number of occasions the cycle time was exceeded in OPERATIONAL (cycle was not completed in time or the next cycle began too early)	UINT16	RO	0x0000 (0 _{dec})
1C33:0D	Shift too short counter	Number of occasions that the interval between SYNC0 and SYNC1 event was too short (DC mode only)	UINT16	RO	0x0000 (0 _{dec})
1C33:20	Sync error	The synchronization was not correct in the last cycle (outputs were output too late; DC mode only)	BOOLEAN	RO	0x00 (0 _{dec})

Index F009*** Password protection

Index (hex)	Name	Meaning	Data type	Flags	Default
F009:0	Password protection	Password protection user calibration [► 259]	UINT32	RW	0x00000000 (0 _{dec})

***) for EL31xx, see [note](#) [► 259]

5.6.7.3 EL3174-0090

5.6.7.3.1 Restore object

Index 1011 Restore default parameters

Index (hex)	Name	Meaning	Data type	Flags	Default
1011:0	Restore default parameters [▶ 503]	Restore default parameters	UINT8	RO	0x01 (1 _{dec})
1011:01	SubIndex 001	If this object is set to “0x64616F6C” in the set value dialog, all backup objects are reset to their delivery state.	UINT32	RW	0x00000000 (0 _{dec})

5.6.7.3.2 Configuration data

Index 80n0*** AI settings (for 0 ≤ n ≤ 3)

Index (hex)	Name	Meaning	Data type	Flags	Default
80n0:0	AI Settings	Maximum subindex	UINT8	RO	0x18 (24 _{dec})
80n0:01	Enable user scale [▶ 269]	User scale is active.	BOOLEAN	RW	0x00 (0 _{dec})
80n0:02	Presentation [▶ 244]	0: Signed presentation 1: Unsigned presentation 2: Absolute value with MSB as sign Signed amount representation	BIT3	RW	0x00 (0 _{dec})
80n0:05	Siemens bits [▶ 246]	The S5 bits are displayed in the three low-order bits	BOOLEAN	RW	0x00 (0 _{dec})
80n0:06	Enable filter	Enable filter, which makes PLC-cycle-synchronous data exchange unnecessary	BOOLEAN	RW	0x00 (0 _{dec})
80n0:07	Enable limit 1 [▶ 246]	Limit 1 enabled	BOOLEAN	RW	0x00 (0 _{dec})
80n0:08	Enable limit 2 [▶ 246]	Limit 2 enabled	BOOLEAN	RW	0x00 (0 _{dec})
80n0:0A	Enable user calibration [▶ 269]	Enabling of the user calibration	BOOLEAN	RW	0x00 (0 _{dec})
80n0:0B	Enable vendor calibration [▶ 269]	Enabling of the vendor calibration	BOOLEAN	RW	0x01 (1 _{dec})
80n0:0E	Swap limit bits [▶ 247]	Changing of the Limit Bits	BOOLEAN	RW	0x00 (0 _{dec})
80n0:11	User scale offset [▶ 269]	User scaling offset	INT16	RW	0x0000 (0 _{dec})
80n0:12	User scale gain [▶ 269]	User scaling gain. The gain is represented in fixed-point format, with the factor 2 ⁻¹⁶ . The value 1 corresponds to 65536 _{dec} (0x00010000) and is limited to ±0x7FFFF	INT32	RW	0x00010000 (65536 _{dec})
80n0:13	Limit 1 [▶ 246]	First limit value for setting the status bits	INT16	RW	0x0000 (0 _{dec})
80n0:14	Limit 2 [▶ 246]	Second limit value for setting the status bits	INT16	RW	0x0000 (0 _{dec})
80n0:15	Filter settings	This object determines the digital filter settings, if it is active via Enable filter (index 0x80n0:06 [▶ 473]). The possible settings are sequentially numbered. 0: 50 Hz FIR 1: 60 Hz FIR 2: IIR 1 3: IIR 2 4: IIR 3 5: IIR 4 6: IIR 5 7: IIR 6 8: IIR 7 9: IIR 8	UINT16	RW	0x0000 (0 _{dec})
80n0:17	User calibration offset [▶ 269]	User offset compensation	INT16	RW	0x0000 (0 _{dec})
80n0:18	User calibration gain [▶ 269]	User calibration gain	INT16	RW	0x4000 (16384 _{dec})

***) since revision no. EL31xx-00xx-0016

Filter

The filters of the EL30xx/EL31xx are activated or deactivated via the CoE index 0x8000:15.

i The filter characteristics are set via index 0x8000:15

The filter frequencies are set for all channels of the EL30xx/EL31xx terminals centrally via index 0x8000:15 (channel 1). All other corresponding indices 0x80n0:15 have no parameterization function! The latest firmware version (see [status table](#) [▶ 484]) returns an EtherCAT-compliant error message, if the filter characteristics of other channels (index 0x80n0:06, 0x80n0:15) are set.

Index 80nD AI Advanced settings (for $0 \leq n \leq 3$, only EL3174 and EL3174-00xx)

Index (hex)	Name	Meaning	Data type	Flags	Default	
80nD:0	AI Advanced Settings	Maximum subindex	UINT8	RO	0x12 (18 _{dec})	
80nD:11	Input Type	Measurement mode, allowed values:	UINT16	RW	0x0002 (2 _{dec})	
		0x01				±60 V (only EL3174-0042)
		0x02				±10 V (not EL3174-0032/0042) ±3 V (only EL3174-0032) ±30 V (only EL3174-0042)
		0x0D				0..60 V (only EL3174-0042)
		0x0E				0..10 V (not EL3174-0032/0042) 0..3 V (only EL3174-0032) 0..30 V (only EL3174-0042)
		0x11				±20 mA (not EL3174-0042)
		0x12				0..20 mA (not EL3174-0042)
		0x13				4.. 20 mA (not EL3174-0042)
0x14	4..20 mA (NAMUR) (not EL3174-0042)					
80nD:12	Scaler	Scaling range, allowed values:	UINT16	RW	0x0000 (0 _{dec})	
		0x00				Extended Range
		0x03				0x03 Legacy Range
80nD:17	Low Range Error	Lower threshold for setting the error bit and error led	INT32	RW	Dependent on 80nD:11	
80nD:18	High Range Error	Upper threshold for setting the error bit and error led	INT32	RW	Dependent on 80nD:11	

Index 8040 TSC Settings

Index (hex)	Name	Meaning	Data type	Flags	Default value
8040:0	TSC Settings [▶ 272]	Max. ubindex	UINT8	RO	0x02 (2 _{dec})
8040:01	Address	TwinSAFE SC Address	UINT16	RW	0x0000 (0 _{dec})
8040:02	Connection Mode	Selection of TwinSAFE SC CRC	UINT32	RO	0x00000000 (0 _{dec})

5.6.7.3.3 Profile-specific objects (0x6000-0xFFFF)

The profile-specific objects have the same meaning for all EtherCAT slaves that support the profile 5001.

5.6.7.3.3.1 Input data

Index 60n0*** AI inputs (for $0 \leq n \leq 3$)

Index (hex)	Name	Meaning	Data type	Flags	Default
60n0:0	AI inputs	Maximum subindex	INT16	RO	0x11 (17 _{dec})
60n0:01	Underrange	Value below measuring range.	BOOLEAN	RO	0x00 (0 _{dec})
60n0:02	Overrange	Measuring range exceeded.	BOOLEAN	RO	0x00 (0 _{dec})
60n0:03	Limit 1	Limit value monitoring Limit 1 0: not active 1: value is smaller than limit value 1 2: value is larger than limit value 1 3: Value is equal to limit value 1	BIT2	RO	0x00 (0 _{dec})
60n0:05	Limit 2	Limit value monitoring limit 2 0: not active 1: value is smaller than limit value 2 2: value is larger than limit value 2 3: Value is equal to limit value 2	BIT2	RO	0x00 (0 _{dec})
60n0:07	Error	The error bit is set if the data is invalid (over-range, under-range)	BOOLEAN	RO	0x00 (0 _{dec})
60n0:0E	Sync error	The Sync error bit is only required for DC mode. It indicates whether a synchronization error has occurred during the previous cycle. This means a SYNC signal was triggered in the EL31xx, although no new process data were available (0=OK, 1=NOK).	BOOLEAN	RO	0x00 (0 _{dec})
60n0:0F	TxPDO State	Validity of the data of the associated TxPDO (0 = valid, 1 = invalid).	BOOLEAN	RO	0x00 (0 _{dec})
60n0:10	TxPDO Toggle	The TxPDO toggle is toggled by the slave when the data of the associated TxPDO is updated.	BOOLEAN	RO	0x00 (0 _{dec})
60n0:11	Value	Analog input date	INT16	RO	0x0000 (0 _{dec})

***) since revision no. EL31xx-00xx-0016

5.6.7.3.3.2 Output data

Index 7040 TSC Master Frame Elements

Index (hex)	Name	Meaning	Data type	Flags	Default value
7040:0	TSC Master Frame Elements	Max. subindex	UINT8	RO	0x03 (3 _{dec})
7040:01	TSC__Master Cmd	reserved	UINT8	RO	0x00 (0 _{dec})
7040:02	TSC__Master ConnID	reserved	UINT16	RO	0x0000 (0 _{dec})
7040:03	TSC__Master CRC_0	reserved	UINT16	RO	0x0000 (0 _{dec})

5.6.7.3.3.3 Configuration data (vendor-specific)

Index 80nF AI Vendor data (for $0 \leq n \leq 3$, only EL3174 and EL3174-00xx)

Index (hex)	Name	Meaning	Data type	Flags	Default
80nF:0	AI Vendor data	Maximum subindex	UINT8	RO	0x06 (6 _{dez})
80nF:01	R0 offset	Offset (Vendor calibration)	INT16	RW	0x0000 (0 _{dez})
80nF:02	R0 gain	Gain (Vendor calibration)	INT16	RW	0x4000 (16384 _{dez})
80nF:03	R1 offset	Offset (Vendor calibration)	INT16	RW	0x0000 (0 _{dez})
80nF:04	R1 gain	Gain (Vendor calibration)	INT16	RW	0x4000 (16384 _{dez})
80nF:05	R2 offset	Offset (Vendor calibration)	INT16	RW	0x0000 (0 _{dez})
80nF:06	R2 gain	Gain (Vendor calibration)	INT16	RW	0x4000 (16384 _{dez})

5.6.7.3.3.4 Information and diagnostic data

Index 80nE*** AI internal data (for $0 \leq n \leq 3$)

Index (hex)	Name	Meaning	Data type	Flags	Default
80nE:0	AI internal data	Maximum subindex	UINT8	RO	0x01 (1 _{dec})
80nE:01	ADC raw value	ADC raw value	UINT16	RO	-

***) since revision no. EL31xx-00xx-0016

Index F000*** Modular device profile

Index (hex)	Name	Meaning	Data type	Flags	Default
F000:0	Modular device profile	General information for the modular device profile	UINT8	RO	0x02 (2 _{dec})
F000:01	Module index distance	Index spacing of the objects of the individual channels	UINT16	RO	0x0010 (16 _{dec})
F000:02	Maximum number of modules	Number of channels	UINT16	RO	Max. Channels number of the terminal

***) since revision no. EL31xx-00xx-0016

Index F008*** Code word

Index	Name	Meaning	Data type	Flags	Default
F008:0	Code word	reserved	UINT32	RW	0x00000000 (0 _{dec})

***) since revision no. EL31xx-00xx-0016

Index F010*** module list (for $1 \leq n \leq 4$, depends on number of channels)

Index (hex)	Name	Meaning	Data type	Flags	Default
F010:0	Module list	Maximum subindex	UINT8	RW	0x0n
F010:0n	SubIndex 00n	Analog input profile (300)	UINT32	RW	0x0000012C (300 _{dec})

***) since revision no. EL31xx-00xx-0016

5.6.7.3.4 Standard objects

Standard objects (0x1000-0x1FFF)

The standard objects have the same meaning for all EtherCAT slaves.

Index 1000 Device type

Index (hex)	Name	Meaning	Data type	Flags	Default
1000:0	Device type	Device type of the EtherCAT slave: the Lo-Word contains the CoE profile used (5001). The Hi-Word contains the module profile according to the modular device profile.	UINT32	RO	0x012C1389 (19665801 _{dec})

Index 1008 Device name

Index (hex)	Name	Meaning	Data type	Flags	Default
1008:0	Device name	Device name of the EtherCAT slave	STRING	RO	EL31xx

Index 1009 Hardware version

Index (hex)	Name	Meaning	Data type	Flags	Default
1009:0	Hardware version	Hardware version of the EtherCAT slave	STRING	RO	00

Index 100A Software version

Index (hex)	Name	Meaning	Data type	Flags	Default
100A:0	Software version	Firmware version of the EtherCAT slave	STRING	RO	-

Index 1018 Identity

Index (hex)	Name	Meaning	Data type	Flags	Default
1018:0	Identity	Information for identifying the slave	UINT8	RO	0x04 (4 _{dec})
1018:01	Vendor ID	Vendor ID of the EtherCAT slave	UINT32	RO	0x00000002 (2 _{dec})
1018:02	Product code	Product code of the EtherCAT slave	UINT32	RO	0xFFFF3052
1018:03	Revision	Revision number of the EtherCAT slave; the low word (bit 0-15) indicates the special terminal number, the high word (bit 16-31) refers to the device description	UINT32	RO	-
1018:04	Serial number	Serial number of the EtherCAT slave; the low byte (bit 0-7) of the low word contains the year of production, the high byte (bit 8-15) of the low word contains the week of production, the high word (bit 16-31) is 0	UINT32	RO	-

Index 10F0* Backup parameter handling**

Index (hex)	Name	Meaning	Data type	Flags	Default
10F0:0	Backup parameter handling	Information for standardized loading and saving of backup entries	UINT8	RO	0x01 (1 _{dec})
10F0:01	Checksum	Checksum across all backup entries of the EtherCAT slave	UINT32	RO	-

***) since revision no. EL31xx-00xx-0016

Index 1600 TSC RxPDO-Map Master Message

Index (hex)	Name	Meaning	Data type	Flags	Default value
1600:0	TSC RxPDO-Map Master Message	PDO Mapping RxPDO	UINT8	RO	0x04 (4 _{dec})
1600:01	SubIndex 001	1. PDO Mapping entry (object 0x7040 (TSC Master Frame Elements), entry 0x01 (TSC__Master Cmd))	UINT32	RO	0x7040:01, 8
1600:02	SubIndex 002	2. PDO Mapping entry (8 bits align)	UINT32	RO	0x0000:00, 8
1600:03	SubIndex 003	3. PDO Mapping entry (object 0x7040 (TSC Master Frame Elements), entry 0x03 (TSC__Master CRC_0))	UINT32	RO	0x7040:03, 16
1600:04	SubIndex 004	4. PDO Mapping entry (object 0x7040 (TSC Master Frame Elements), entry 0x02 (TSC__Master ConnID))	UINT32	RO	0x7040:02, 16

Index 180n* (AI) TxPDO-Par (for 0 ≤ n ≤ 7, depends on number of channels)**

Index (hex)	Name	Meaning	Data type	Flags	Default																		
180n:0	AI TxPDO-Par Standard	PDO Parameter TxPDO	UINT8	RO	0x06 (6 _{dez})																		
180n:06	Exclude TxPDOs	Specifies the TxPDOs (index of TxPDO mapping objects) that must not be transferred together with this PDO	OCTET-STRING[2]	RO	<table border="1"> <thead> <tr> <th>n=</th> <th>Wert:</th> </tr> </thead> <tbody> <tr><td>0</td><td>0x011A</td></tr> <tr><td>1</td><td>0x001A</td></tr> <tr><td>2</td><td>0x031A</td></tr> <tr><td>3</td><td>0x021A</td></tr> <tr><td>4</td><td>0x051A</td></tr> <tr><td>5</td><td>0x041A</td></tr> <tr><td>6</td><td>0x071A</td></tr> <tr><td>7</td><td>0x061A</td></tr> </tbody> </table>	n=	Wert:	0	0x011A	1	0x001A	2	0x031A	3	0x021A	4	0x051A	5	0x041A	6	0x071A	7	0x061A
n=	Wert:																						
0	0x011A																						
1	0x001A																						
2	0x031A																						
3	0x021A																						
4	0x051A																						
5	0x041A																						
6	0x071A																						
7	0x061A																						

***) since revision no. EL31xx-00xx-0016

Index 1A0n AI TxPDO-Map Standard (for n = 0, 2, 4, 6; p = 0, 1, 2, 3; depending on the number of channels, not applicable for EL31x2)

Index (hex)	Name	Meaning	Data type	Flags	Default
1A0n:0	AI TxPDO-Map standard	PDO Mapping TxPDO	UINT8	RO	0x0B (11 _{dec})
1A0n:01	SubIndex 001	1. PDO Mapping entry (object 0x60p0 (AI Inputs), entry 0x01 (Underrange))	UINT32	RO	0x60p0:01, 1
1A0n:02	SubIndex 002	2. PDO Mapping entry (object 0x60p0 (AI Inputs), entry 0x02 (Overrange))	UINT32	RO	0x60p0:02, 1
1A0n:03	SubIndex 003	3. PDO Mapping entry (object 0x60p0 (AI Inputs), entry 0x03 (Limit 1))	UINT32	RO	0x60p0:03, 2
1A0n:04	SubIndex 004	4. PDO Mapping entry (object 0x60p0 (AI Inputs), entry 0x05 (Limit 2))	UINT32	RO	0x60p0:05, 2
1A0n:05	SubIndex 005	5. PDO Mapping entry (object 0x60p0 (AI Inputs), entry 0x07 (Error))	UINT32	RO	0x60p0:07, 2
1A0n:06	SubIndex 006	6. PDO Mapping entry (1 bit align)	UINT32	RO	0x0000:00, 1
1A0n:07	SubIndex 007	7. PDO Mapping entry (5 bits align)	UINT32	RO	0x0000:00, 5
1A0n:08	SubIndex 008	8. PDO Mapping entry (object 0x1C32 (SM input parameter), entry 0x20 (Sync error))	UINT32	RO	0x1C32:20, 1
1A0n:09	SubIndex 009	9. PDO Mapping entry (object 0x180n (AI TxPDO-Par standard), entry 0x07 (TxPDO State))	UINT32	RO	0x180n:07, 1
1A0n:0A	SubIndex 010	10. PDO Mapping entry (object 0x180n (AI TxPDO-Par standard), entry 0x09 (TxPDO Toggle))	UINT32	RO	0x180n:09, 1
1A0n:0B	SubIndex 011	11. PDO Mapping entry (object 0x60p0 (AI Inputs), entry 0x11 (Value))	UINT32	RO	0x60p0:11, 16

Index 1A0n AI TxPDO-Map Compact (for n = 1, 3, 5, 7; p = 0, 1, 2, 3; depending on the number of channels, not applicable for EL31x2)

Index (hex)	Name	Meaning	Data type	Flags	Default
1A0n:0	AI TxPDO-Map Compact	PDO Mapping TxPDO	UINT8	RO	0x01 (1 _{dec})
1A0n:01	SubIndex 001	1. PDO Mapping entry (object 0x60p0 (AI Inputs), entry 0x11 (Value))	UINT32	RO	0x60p0:11, 16

Index 1A08 TSC TxPDO-Map Slave Message

Index (hex)	Name	Meaning	Data type	Flags	Default
1A08:0	TSC TxPDO-Map Slave Message	PDO Mapping TxPDO	UINT8	RW	0x0A (10 _{dec})
1A08:01	SubIndex 001	1. PDO Mapping entry (object 0x6040 (TSC Slave Frame Elements), entry 0x01 (TSC__Slave Cmd))	USINT8	RW	0x6040:01, 8
1A08:02	SubIndex 002	2. PDO Mapping entry (object 0x6000 (ENC Inputs), entry 0x11 (Counter value))	INT16	RW	0x6000:11, 16
1A08:03	SubIndex 003	3. PDO Mapping entry (object 0x6040 (TSC Slave Frame Elements), entry 0x03 (TSC__Slave CRC_0))	UINT16	RW	0x6040:03, 16
1A08:04	SubIndex 004	4. PDO Mapping entry (object 0x6010 (ENC Inputs), entry 0x11 (Counter value))	INT16	RW	0x6010:11, 16
1A08:05	SubIndex 005	5. PDO Mapping entry (object 0x6040 (TSC Slave Frame Elements), entry 0x04 (TSC__Slave CRC_1))	UINT16	RW	0x6040:04, 16
1A08:06	SubIndex 006	6. PDO Mapping entry (object 0x6020 (ENC Inputs), entry 0x11 (Counter value))	INT16	RW	0x6020:11, 16
1A08:07	SubIndex 007	7. PDO Mapping entry (object 0x6040 (TSC Slave Frame Elements), entry 0x05 (TSC__Slave CRC_2))	UINT16	RW	0x6040:05, 16
1A08:08	SubIndex 008	8. PDO Mapping entry (object 0x6030 (ENC Inputs), entry 0x11 (Counter value))	INT16	RW	0x6030:11, 16
1A08:09	SubIndex 009	9. PDO Mapping entry (object 0x6040 (TSC Slave Frame Elements), entry 0x06 (TSC__Slave CRC_3))	UINT16	RW	0x6040:06, 16
1A08:0A	SubIndex 010	10. PDO Mapping entry (object 0x6040 (TSC Slave Frame Elements), entry 0x02 (TSC__Slave ConnID))	UINT16	RW	0x6040:02, 16

Index 1C00 Sync manager type

Index (hex)	Name	Meaning	Data type	Flags	Default
1C00:0	Sync manager type	Using the sync managers	UINT8	RO	0x04 (4 _{dec})
1C00:01	SubIndex 001	Sync-Manager Type Channel 1: Mailbox Write	UINT8	RO	0x01 (1 _{dec})
1C00:02	SubIndex 002	Sync-Manager Type Channel 2: Mailbox Read	UINT8	RO	0x02 (2 _{dec})
1C00:03	SubIndex 003	Sync-Manager Type Channel 3: Process Data Write (Outputs)	UINT8	RO	0x03 (3 _{dec})
1C00:04	SubIndex 004	Sync-Manager Type Channel 4: Process Data Read (Inputs)	UINT8	RO	0x04 (4 _{dec})

Index 1C12 RxPDO assign

Index (hex)	Name	Meaning	Data type	Flags	Default
1C12:0	RxPDO assign	PDO Assign Outputs	UINT8	RW	0x1600 (5632 _{dec})

Index 1C13 TxPDO assign

For operation on masters other than TwinCAT it must be ensured that the channels are entered in the PDO assignment ("TxPDO assign", object 0x1C13) successively.

Index (hex)	Name	Meaning	Data type	Flags	Default
1C13:0	TxPDO assign	PDO Assign Inputs	UINT8	RW	0x04 (4 _{dec})
1C13:01	SubIndex 001	1. zugeordnete TxPDO (enthält den Index des zugehörigen TxPDO Mapping Objekts)	UINT16	RW	0x1A00 (6656 _{dec})
1C13:02	SubIndex 002	2. zugeordnete TxPDO (enthält den Index des zugehörigen TxPDO Mapping Objekts)	UINT16	RW	0x1A02 (6658 _{dec})
1C13:03	SubIndex 003	3. zugeordnete TxPDO (enthält den Index des zugehörigen TxPDO Mapping Objekts)	UINT16	RW	0x1A04 (6660 _{dec})
1C13:04	SubIndex 004	4. zugeordnete TxPDO (enthält den Index des zugehörigen TxPDO Mapping Objekts)	UINT16	RW	0x1A06 (6662 _{dec})
1C13:05	SubIndex 004	5. zugeordnete TxPDO (enthält den Index des zugehörigen TxPDO Mapping Objekts)	UINT16	RW	0x1A08 (6664 _{dec})

Index 1C32 SM output parameter

Index (hex)	Name	Meaning	Data type	Flags	Default
1C32:0	SM output parameter	Synchronization parameters for the outputs	UINT8	RO	0x07 (7 _{dec})
1C32:01	Sync mode	Current synchronization mode: <ul style="list-style-type: none"> 0: Free Run 1: Synchron with SM 2 Event 2: DC-Mode - Synchron with SYNC0 Event 3: DC-Mode - Synchron with SYNC1 Event 	UINT16	RW	0x0001 (1 _{dec})
1C32:02	Cycle time	Cycle time (in ns): <ul style="list-style-type: none"> Free Run: Cycle time of the local timer Synchronous with SM 2 event: Master cycle time DC-Mode: SYNC0/SYNC1 Cycle Time 	UINT32	RW	0x00000000 (0 _{dec})
1C32:03	Shift time	Time between SYNC0 event and output of the outputs (in ns, DC mode only)	UINT32	RW	0x00000000 (0 _{dec})
1C32:04	Sync modes supported	Supported synchronization modes: <ul style="list-style-type: none"> Bit 0 = 1: free run is supported Bit 1 = 1: Synchronous with SM 2 event is supported Bit 2-3 = 01: DC mode is supported Bit 4-5 = 10: Output shift with SYNC1 event (only DC mode) Bit 14 = 1: dynamic times (measurement through writing of 1C32:08 [▶ 480]) 	UINT16	RO	0x8007 (32775 _{dec})
1C32:05	Minimum cycle time	Minimum cycle time (in ns)	UINT32	RO	0x00000000 (0 _{dec})
1C32:06	Calc and copy time	Minimum time between SYNC0 and SYNC1 event (in ns, DC mode only)	UINT32	RO	0x00000000 (0 _{dec})
1C32:08	Command	<ul style="list-style-type: none"> 0: Measurement of the local cycle time is stopped 1: Measurement of the local cycle time is started <p>The entries 1C32:03 [▶ 480], 1C32:05 [▶ 480], 1C32:06 [▶ 480], 1C32:09 [▶ 480] are updated with the maximum measured values. For a subsequent measurement the measured values are reset</p>	UINT16	RW	0x0000 (0 _{dec})
1C32:09	Delay time	Time between SYNC1 event and output of the outputs (in ns, DC mode only)	UINT32	RO	0x00000000 (0 _{dec})
1C32:0B	SM event missed counter	Number of missed SM events in OPERATIONAL (DC mode only)	UINT16	RO	0x0000 (0 _{dec})
1C32:0C	Cycle exceeded counter	Number of occasions the cycle time was exceeded in OPERATIONAL (cycle was not completed in time or the next cycle began too early)	UINT16	RO	0x0000 (0 _{dec})
1C32:0D	Shift too short counter	Number of occasions that the interval between SYNC0 and SYNC1 event was too short (DC mode only)	UINT16	RO	0x0000 (0 _{dec})
1C32:20	Sync error	The synchronization was not correct in the last cycle (outputs were output too late; DC mode only)	BOOLEAN	RO	0x00 (0 _{dec})

Index 1C33 SM input parameter

Index (hex)	Name	Meaning	Data type	Flags	Default
1C33:0	SM input parameter	Synchronization parameters for the inputs	UINT8	RO	0x20 (32 _{dec})
1C33:01	Sync mode	Current synchronization mode: <ul style="list-style-type: none"> • Bit 0 = 0: Free Run • Bit 0 = 1: Synchron with SM 2 Event • Bit 15 = 0: Standard • Bit 15 = 1: FastOp mode (CoE deactivated) 	UINT16	RW	0x0000 (0 _{dec})
1C33:02	Cycle time	Cycle time (in ns): <ul style="list-style-type: none"> • Free Run: Cycle time of the local timer • Synchronous with SM 2 event: Master cycle time • DC-Mode: SYNC0/SYNC1 Cycle Time 	UINT32	RW	0x000F4240 (1000000 _{dec})
1C33:03	Shift time	Time between SYNC0 event and reading of the inputs (in ns, only DC mode)	UINT32	RO	0x00000000 (0 _{dec})
1C33:04	Sync modes supported	Supported synchronization modes: <ul style="list-style-type: none"> • Bit 0: free run is supported • Bit 1: synchronous with SM 2 event is supported (outputs available) • Bit 1: synchronous with SM 3 event is supported (no outputs available) • Bit 2-3 = 01: DC mode is supported • Bit 4-5 = 01: input shift through local event (outputs available) • Bit 4-5 = 10: input shift with SYNC1 event (no outputs available) • Bit 14 = 1: dynamic times (measurement through writing of 0x1C33:08) 	UINT16	RO	0xC003 (49155 _{dec})
1C33:05	Minimum cycle time	Minimum cycle time (in ns)	UINT32	RO	0x0000FDE8 (65000 _{dec})
1C33:06	Calc and copy time	Time between reading of the inputs and availability of the inputs for the master (in ns, only DC mode)	UINT32	RO	0x00000000 (0 _{dec})
1C33:07	Minimum delay time		UINT32	RO	0x00000000 (0 _{dec})
1C33:08	Get cycle time	With this entry the real required process data provision time can be measured. <ul style="list-style-type: none"> • 0: Measurement of the local cycle time is stopped • 1: Measurement of the local cycle time is started The entries 0x1C33:03, 0x1C33:06, 1C33:09 are updated with the maximum measured values. For a subsequent measurement the measured values are reset.	UINT16	RW	0x0000 (0 _{dec})
1C33:09	Maximum delay time	Time between SYNC1 event and reading of the inputs (in ns, only DC mode)	UINT32	RO	0x00000000 (0 _{dec})
1C33:0B	SM event missed counter	Number of missed SM events in OPERATIONAL (DC mode only)	UINT16	RO	0x0000 (0 _{dec})
1C33:0C	Cycle exceeded counter	Number of occasions the cycle time was exceeded in OPERATIONAL (cycle was not completed in time or the next cycle began too early)	UINT16	RO	0x0000 (0 _{dec})
1C33:0D	Shift too short counter	Number of occasions that the interval between SYNC0 and SYNC1 event was too short (DC mode only)	UINT16	RO	0x0000 (0 _{dec})
1C33:20	Sync error	The synchronization was not correct in the last cycle (outputs were output too late; DC mode only)	BOOLEAN	RO	0x00 (0 _{dec})

Index F009* Password protection**

Index (hex)	Name	Meaning	Data type	Flags	Default
F009:0	Password protection	Password protection user calibration [► 259]	UINT32	RW	0x00000000 (0 _{dec})

***) for EL31xx, see [note \[► 259\]](#)

5.7 Error messages and diagnosis

Table of contents	
• Error messages to the EtherCAT master [▶ 482]	
• Interference from equipment [▶ 482]	

EtherCAT master error messages

EtherCAT error messages specifically for the EL31xx are

Number	Designation	Explanation
0x0609003 1	ABORT_VALUE_TOO_GREAT	CoE 0x8000:12 (user scale gain greater than 0x0007FFFF)
0x0609003 2	ABORT_VALUE_TOO_SMALL	CoE 0x8000:12 (user scale gain smaller than -0x0007FFFF)
0x0800002 1	ABORT_DATA_CANNOT_BE_READ_OR_STORED_BECAUSE_OF_LOCAL_CONTROL	CoE 0x80nF:0x no authorization to write manufacturer data CoE 1C33: Contents locked because filter active

The Beckhoff TwinCAT EtherCAT master outputs the slave error message according to the ETG specification in plain text in the logger window:

Server (Port)	Timestamp	Message
(65535)	15.03.2010 17:03:04 1 ms	'Term 5 (EL3102)' (1002) 'PS': CoE ('InitDown' 0x800F:01) - SDO Abort ('Data cannot be transferred or stored to the application because of local control.', 0x08000021): 'Calibration offset'.
TCPLC.PlcAux:Task (801)	15.03.2010 17:03:03 132 ms	PLC Download: 610 Symbols, 381 DataTypes
TCPLC.PlcAux:Task (801)	15.03.2010 17:03:03 132 ms	PLC Download: 610 Symbols, 381 DataTypes
TwinCAT System (10000)	15.03.2010 17:02:58 796 ms	Starting COM Server TcEventLogger !
TwinCAT System (10000)	15.03.2010 17:02:58 468 ms	TCRTIME Server started: TCRTIME.
TwinCAT System (10000)	15.03.2010 17:02:58 468 ms	TCPLC Server started: TCPLC.
TwinCAT System (10000)	15.03.2010 17:02:58 468 ms	TCIO Server started: TCIO.

Fig. 229: TwinCAT logger window, example of incorrect StartUp entry under TwinCAT 2.11

Interference from equipment

When operating the EL31xx analog EtherCAT terminals, high frequency superimposed signals from interfering devices (e.g. proportional valves, stepper motors or DC motor output stages) can be picked up by the terminal. In order to guarantee interference-free operation, we recommend the use of separate power supply units for the terminals and the interference-causing devices.

6 Appendix

6.1 EtherCAT AL Status Codes

For detailed information please refer to the [EtherCAT system description](#).

6.2 Firmware compatibility

Beckhoff EtherCAT devices are delivered with the latest available firmware version. Compatibility of firmware and hardware is mandatory; not every combination ensures compatibility. The overview below shows the hardware versions on which a firmware can be operated.

Note

- It is recommended to use the newest possible firmware for the respective hardware
- Beckhoff is not under any obligation to provide customers with free firmware updates for delivered products.

NOTICE

Risk of damage to the device!

Pay attention to the instructions for firmware updates on the [separate page \[▶ 491\]](#).

If a device is placed in BOOTSTRAP mode for a firmware update, it does not check when downloading whether the new firmware is suitable.

This can result in damage to the device! Therefore, always make sure that the firmware is suitable for the hardware version!

EL3101			
Hardware (HW)	Firmware	Revision no.	Date of release
00 - 10*	01	EL3101-0000-0016	2010/09
		EL3101-0000-0017	2012/08
	(02)	EL3101-0000-0018	2013/12
		EL3101-0000-0019	2017/02
	02*	EL3101-0000-0019	2024/01

EL3102			
Hardware (HW)	Firmware	Revision no.	Date of release
05 - 09	05	EL3102-0000-0000	2005/02
	06		2005/03
09 - 28*	07	EL3102-0000-0016	2010/04
	08	EL3102-0000-0017	2010/06
	09		2010/10
	10		2011/01
	11		2012/03
		EL3102-0000-0018	2012/10
	12	EL3102-0000-0019	2014/05
	(13)	EL3102-0000-0020	2014/10
13*	EL3102-0000-0020	2024/01	

EL3104			
Hardware (HW)	Firmware	Revision no.	Date of release
00 - 17*	01	EL3104-0000-0016	2010/07
	02		2011/01
	03		2012/03
		EL3104-0000-0017	2012/07
	(04)	EL3104-0000-0018	2013/12
		EL3104-0000-0019	2016/06
		EL3104-0000-0020	2017/02
	04*	EL3104-0000-0020	2024/01

EL3111			
Hardware (HW)	Firmware	Revision no.	Date of release
00 - 10*	01	EL3111-0000-0016	2010/09
		EL3111-0000-0017	2012/08
	(02)	EL3111-0000-0018	2013/12
		EL3111-0000-0019	2017/02
		EL3111-0000-0020	2016/02
	02*	EL3111-0000-0020	2024/01

EL3112			
Hardware (HW)	Firmware	Revision no.	Date of release
00 - 01	00	EL3112-0000-0000	2005/09
02 - 17*	07	EL3112-0000-0016	2010/04
	08	EL3112-0000-0017	2010/06
	09		2010/10
	10		2011/01
	11		2012/03
		EL3112-0000-0018	2012/11
	12		2013/05
	(13)	EL3112-0000-0019	2014/05
13*	EL3112-0000-0019	2024/01	

EL3112-0011			
Hardware (HW)	Firmware	Revision no.	Date of release
00 - 05*	(01)	EL3112-0011-0016	2016/03
	01*	EL3112-0011-0016	2024/01

EL3114			
Hardware (HW)	Firmware	Revision no.	Date of release
00 - 07	01	EL3114-0000-0016	2010/01
	02		2010/04
	03		2010/04
	04	EL3114-0000-0017	2010/07
	05		2011/01
	06		2012/03
		EL3114-0000-0018	2012/08
	07	EL3114-0000-0019	2013/12
08 - 16*	(08)		2015/11
		EL3114-0000-0020	2016/06
		EL3114-0000-0021	2017/02
	08*	EL3114-0000-0021	2024/01

EL3121			
Hardware (HW)	Firmware	Revision no.	Date of release
00 - 10*	01	EL3121-0000-0016	2010/09
		EL3121-0000-0017	2012/08
	02*	EL3121-0000-0018	2013/12
		EL3121-0000-0019	2017/02

EL3122			
Hardware (HW)	Firmware	Revision no.	Date of release
00 - 02	00	EL3122-0000-0000	2005/09
02 - 17*	07	EL3122-0000-0016	2010/04
	08	EL3122-0000-0017	2010/06
	09		2010/10
	10		2011/01
	11		2011/04
	12		2012/03
		EL3122-0000-0018	2012/11
	13*	EL3122-0000-0019	2014/05

EL3124				
Hardware (HW)	Firmware	Revision no.	Date of release	
00 - 07	01	EL3124-0000-0016	2010/01	
	02		2011/01	
	03		2011/05	
	04			2012/03
		EL3124-0000-0017	2012/08	
	05	EL3124-0000-0018	2013/12	
08 - 16*	06*		2015/11	
		EL3124-0000-0019	2016/06	
		EL3124-0000-0020	2017/02	

EL3124-0090			
Hardware (HW)	Firmware	Revision no.	Date of release
10 - 16*	00	EL3124-0090-0016	2016/10
	01*		2017/02

EL3141			
Hardware (HW)	Firmware	Revision no.	Date of release
00 - 12*	01	EL3141-0000-0016	2010/09
		EL3141-0000-0017	2012/08
	(02)	EL3141-0000-0018	2013/12
		EL3141-0000-0019	2016/06
		EL3141-0000-0020	2017/02
	02*	EL3141-0000-0020	2024/01

EL3142				
Hardware (HW)	Firmware	Revision no.	Date of release	
05 - 10	05	EL3142-0000-0000	2005/02	
10 - 27*	07	EL3142-0000-0016	2010/04	
	08	EL3142-0000-0017	2010/06	
	09		2010/10	
	10		2011/01	
	11			2012/03
			EL3142-0000-0018	2012/10
	12		2013/05	
	(13)	EL3142-0000-0019	2014/05	
13*	EL3142-0000-0019	2024/01		

EL3142-0010				
Hardware (HW)	Firmware	Revision no.	Date of release	
02 - 19*	07	EL3142-0010-0017	2010/09	
	08		2010/10	
	09		2011/01	
	10			2012/03
			EL3142-0010-0018	2012/10
			EL3142-0010-0019	2013/05
	(11)		EL3142-0010-0020	2014/05
			EL3142-0010-0021	2014/01
	11*	EL3142-0010-0021	2024/01	

EL3144				
Hardware (HW)	Firmware	Revision no.	Date of release	
00 - 12*	01	EL3144-0000-0016	2010/07	
	02		2011/05	
	03		2011/05	
	04			2012/03
			EL3144-0000-0017	2013/01
	(05)		EL3144-0000-0018	2013/12
			EL3144-0000-0019	2016/06
			EL3144-0000-0020	2017/02
	05*	EL3144-0000-0020	2024/01	

EL3151			
Hardware (HW)	Firmware	Revision no.	Date of release
00 - 11*	01	EL3151-0000-0016	2010/09
		EL3151-0000-0017	2012/08
	(02)	EL3151-0000-0018	2013/12
		EL3151-0000-0019	2016/06
		EL3151-0000-0020	2017/02
	02*	EL3151-0000-0020	2024/02

EL3152			
Hardware (HW)	Firmware	Revision no.	Date of release
04 - 09	01	EL3152-0000-0000	2005/02
	02		2005/03
09 - 26*	07	EL3152-0000-0016	2010/04
	08	EL3152-0000-0017	2010/06
	09		2010/06
	10		2010/10
	11		2011/01
	12		2011/04
	13		2012/03
		EL3152-0000-0018	2012/10
	(14)	EL3152-0000-0019	2014/05
14*	EL3152-0000-0019	2024/02	

EL3154			
Hardware (HW)	Firmware	Revision no.	Date of release
00 - 16*	01	EL3154-0000-0016	2010/07
	02		2011/05
	03		2011/05
	04		2012/03
		EL3154-0000-0017	2012/07
	(05)	EL3154-0000-0018	2013/12
		EL3154-0000-0019	2016/06
		EL3154-0000-0020	2017/02
	05*	EL3154-0000-0020	2024/02

EL3161			
Hardware (HW)	Firmware	Revision no.	Date of release
00 - 11*	01	EL3161-0000-0016	2010/09
		EL3161-0000-0017	2012/08
	(02)	EL3161-0000-0018	2013/12
		EL3161-0000-0019	2017/02
	02*	EL3161-0000-0019	2024/02

EL3162			
Hardware (HW)	Firmware	Revision no.	Date of release
03 - 07	02	EL3162-0000-0000	2005/02
	03		2005/03
08	04	EL3162-0000-0016	2010/02
09 - 26	07	EL3162-0000-0016	2010/04
	08	EL3162-0000-0017	2010/06
	09		2010/10
	10		2010/11
	11		2012/03
		EL3162-0000-0018	2012/10
	12		2013/05
(13)	EL3162-0000-0019	2014/05	
27*	13*	EL3162-0000-0019	2024/02

EL3164			
Hardware (HW)	Firmware	Revision no.	Date of release
00 - 21*	01	EL3164-0000-0016	2010/07
	02		2011/01
	03		2012/03
		EL3164-0000-0017	2012/08
	(04)	EL3164-0000-0018	2013/12
		EL3164-0000-0019	2016/06
		EL3164-0000-0020	2017/02
04*	EL3164-0000-0020	2024/02	

EL3172			
Hardware (HW)	Firmware	Revision no.	Date of release
02*	01*	EL3172-0000-0016	2024/01

EL3174			
Hardware (HW)	Firmware	Revision no.	Date of release
00 - 05*	03	EL3174-0000-0016	2017/07
	05*	EL3174-0000-0017	2024/02
	(06)		2023/05

EL3174-0002			
Hardware (HW)	Firmware	Revision no.	Date of release
00 - 10*	01	EL3174-0002-0016	2016/12
	02	EL3174-0002-0017	2024/02
	05*		2024/02
	(06)		2023/05

EL3174-0030			
Hardware (HW)	Firmware	Revision no.	Date of release
05*	05*	EL3174-0030-0016	2021/03
		EL3174-0030-0017	2024/02

EL3174-0032			
Hardware (HW)	Firmware	Revision no.	Date of release
00 - 04*	01	EL3174-0032-0016	2024/02
	02		2017/12
	05*		2020/04
	(06)		2023/05

EL3174-0042			
Hardware (HW)	Firmware	Revision no.	Date of release
01*	06*	EL3174-0042-0016	2024/02

EL3174-0090			
Hardware (HW)	Firmware	Revision no.	Date of release
00 - 05*	04*	EL3174-0090-0016	2018/04
		EL3174-0090-0017	2024/02

*) This is the current compatible firmware/hardware version at the time of the preparing this documentation. Check on the Beckhoff web page whether more up-to-date documentation is available.

6.3 Firmware Update EL/ES/EM/ELM/EP/EPP/ERPxxxx

This section describes the device update for Beckhoff EtherCAT slaves from the EL/ES, ELM, EM, EK, EP, EPP and ERP series. A firmware update should only be carried out after consultation with Beckhoff support.

NOTICE

Only use TwinCAT 3 software!

A firmware update of Beckhoff IO devices must only be performed with a TwinCAT 3 installation. It is recommended to build as up-to-date as possible, available for free download on the [Beckhoff website](#).

To update the firmware, TwinCAT can be operated in the so-called FreeRun mode, a paid license is not required.

The device to be updated can usually remain in the installation location, but TwinCAT has to be operated in the FreeRun. Please make sure that EtherCAT communication is trouble-free (no LostFrames etc.).

Other EtherCAT master software, such as the EtherCAT Configurator, should not be used, as they may not support the complexities of updating firmware, EEPROM and other device components.

Storage locations

An EtherCAT slave stores operating data in up to three locations:

- Each EtherCAT slave has a device description, consisting of identity (name, product code), timing specifications, communication settings, etc.
This device description (ESI; EtherCAT Slave Information) can be downloaded from the Beckhoff website in the download area as a [zip file](#) and used in EtherCAT masters for offline configuration, e.g. in TwinCAT.
Above all, each EtherCAT slave carries its device description (ESI) electronically readable in a local memory chip, the so-called **ESI EEPROM**. When the slave is switched on, this description is loaded locally in the slave and informs it of its communication configuration; on the other hand, the EtherCAT master can identify the slave in this way and, among other things, set up the EtherCAT communication accordingly.

NOTICE

Application-specific writing of the ESI-EEPROM

The ESI is developed by the device manufacturer according to ETG standard and released for the corresponding product.

- Meaning for the ESI file: Modification on the application side (i.e. by the user) is not permitted.
- Meaning for the ESI EEPROM: Even if a writeability is technically given, the ESI parts in the EEPROM and possibly still existing free memory areas must not be changed beyond the normal update process. Especially for cyclic memory processes (operating hours counter etc.), dedicated memory products such as EL6080 or IPC's own NOVDRAM must be used.

- Depending on functionality and performance EtherCAT slaves have one or several local controllers for processing I/O data. The corresponding program is the so-called **firmware** in *.efw format.
- In some EtherCAT slaves the EtherCAT communication may also be integrated in these controllers. In this case the controller is usually a so-called **FPGA** chip with *.rbf firmware.

Customers can access the data via the EtherCAT fieldbus and its communication mechanisms. Acyclic mailbox communication or register access to the ESC is used for updating or reading of these data.

The TwinCAT System Manager offers mechanisms for programming all three parts with new data, if the slave is set up for this purpose. Generally the slave does not check whether the new data are suitable, i.e. it may no longer be able to operate if the data are unsuitable.

Simplified update by bundle firmware

The update using so-called **bundle firmware** is more convenient: in this case the controller firmware and the ESI description are combined in a *.efw file; during the update both the firmware and the ESI are changed in the terminal. For this to happen it is necessary

- for the firmware to be in a packed format: recognizable by the file name, which also contains the revision number, e.g. ELxxxx-xxxx_REV0016_SW01.efw

- for password=1 to be entered in the download dialog. If password=0 (default setting) only the firmware update is carried out, without an ESI update.
- for the device to support this function. The function usually cannot be retrofitted; it is a component of many new developments from year of manufacture 2016.

Following the update, its success should be verified

- ESI/Revision: e.g. by means of an online scan in TwinCAT ConfigMode/FreeRun – this is a convenient way to determine the revision
- Firmware: e.g. by looking in the online CoE of the device

NOTICE

Risk of damage to the device!

✓ Note the following when downloading new device files

a) Firmware downloads to an EtherCAT device must not be interrupted

b) Flawless EtherCAT communication must be ensured. CRC errors or LostFrames must be avoided.

c) The power supply must adequately dimensioned. The signal level must meet the specification.

⇒ In the event of malfunctions during the update process the EtherCAT device may become unusable and require re-commissioning by the manufacturer.

6.3.1 Device description ESI file/XML

NOTICE

Attention regarding update of the ESI description/EEPROM

Some slaves have stored calibration and configuration data from the production in the EEPROM. These are irretrievably overwritten during an update.

The ESI device description is stored locally on the slave and loaded on start-up. Each device description has a unique identifier consisting of slave name (9 characters/digits) and a revision number (4 digits). Each slave configured in the System Manager shows its identifier in the EtherCAT tab:

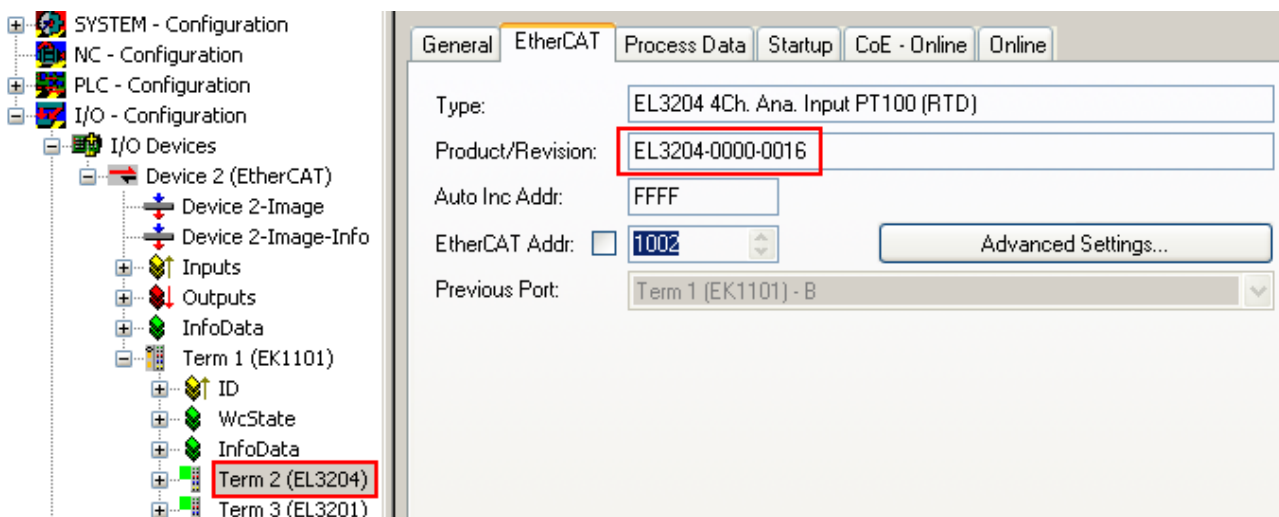

Fig. 230: Device identifier consisting of name EL3204-0000 and revision -0016

The configured identifier must be compatible with the actual device description used as hardware, i.e. the description which the slave has loaded on start-up (in this case EL3204). Normally the configured revision must be the same or lower than that actually present in the terminal network.

For further information on this, please refer to the [EtherCAT system documentation](#).

i Update of XML/ESI description

The device revision is closely linked to the firmware and hardware used. Incompatible combinations lead to malfunctions or even final shutdown of the device. Corresponding updates should only be carried out in consultation with Beckhoff support.

Display of ESI slave identifier

The simplest way to ascertain compliance of configured and actual device description is to scan the EtherCAT boxes in TwinCAT mode Config/FreeRun:

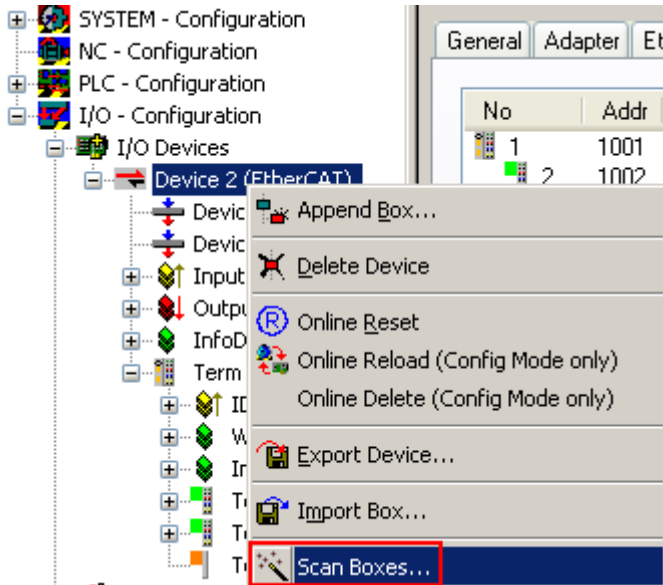

Fig. 231: Scan the subordinate field by right-clicking on the EtherCAT device

If the found field matches the configured field, the display shows



Fig. 232: Configuration is identical

otherwise a change dialog appears for entering the actual data in the configuration.

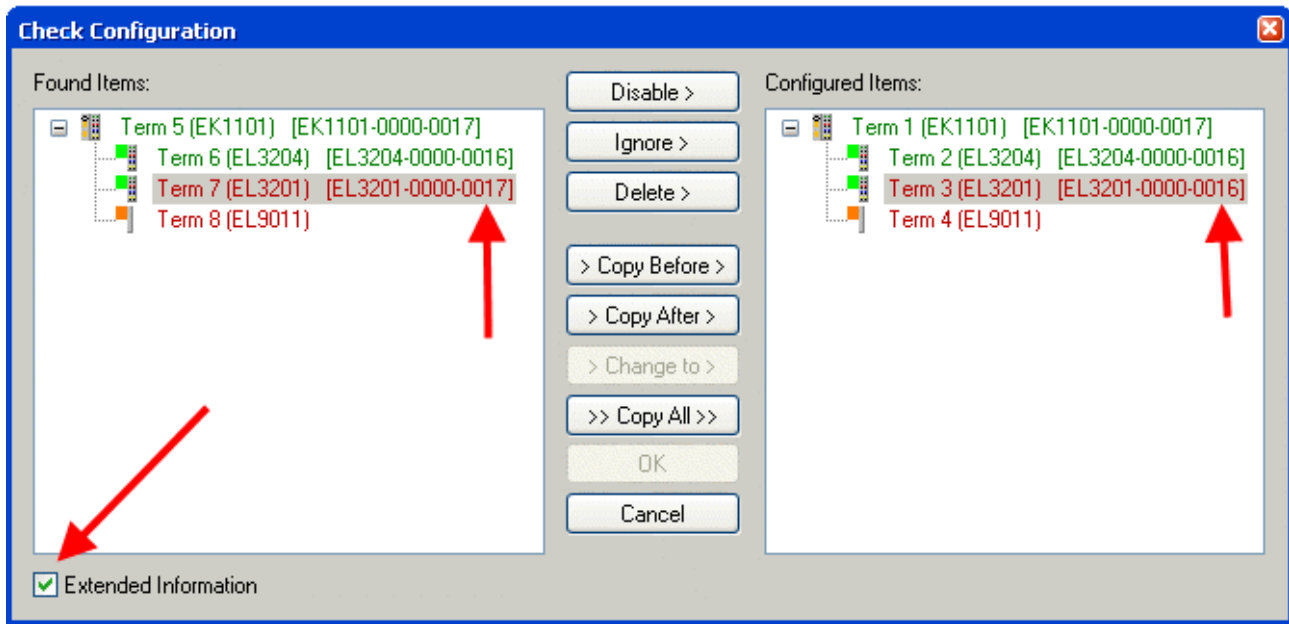

Fig. 233: Change dialog

In this example in Fig. *Change dialog*, an EL3201-0000-0017 was found, while an EL3201-0000-0016 was configured. In this case the configuration can be adapted with the *Copy Before* button. The *Extended Information* checkbox must be set in order to display the revision.

Changing the ESI slave identifier

The ESI/EEPROM identifier can be updated as follows under TwinCAT:

- Trouble-free EtherCAT communication must be established with the slave.
- The state of the slave is irrelevant.
- Right-clicking on the slave in the online display opens the *EEPROM Update* dialog, Fig. *EEPROM Update*

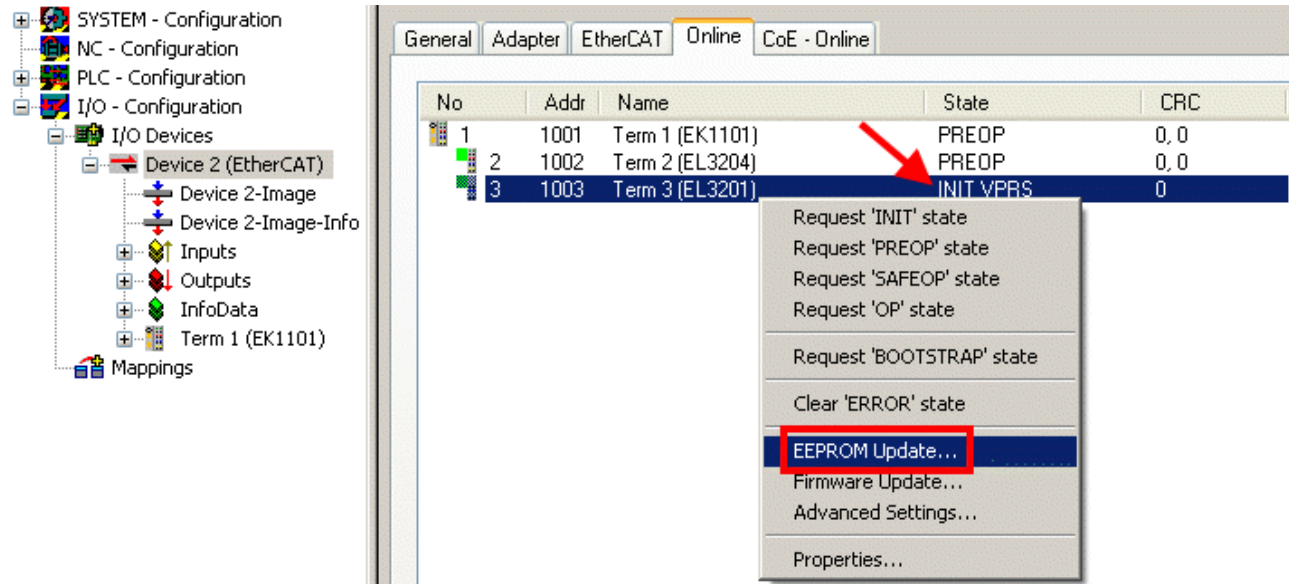

Fig. 234: EEPROM Update

The new ESI description is selected in the following dialog, see Fig. *Selecting the new ESI*. The checkbox *Show Hidden Devices* also displays older, normally hidden versions of a slave.

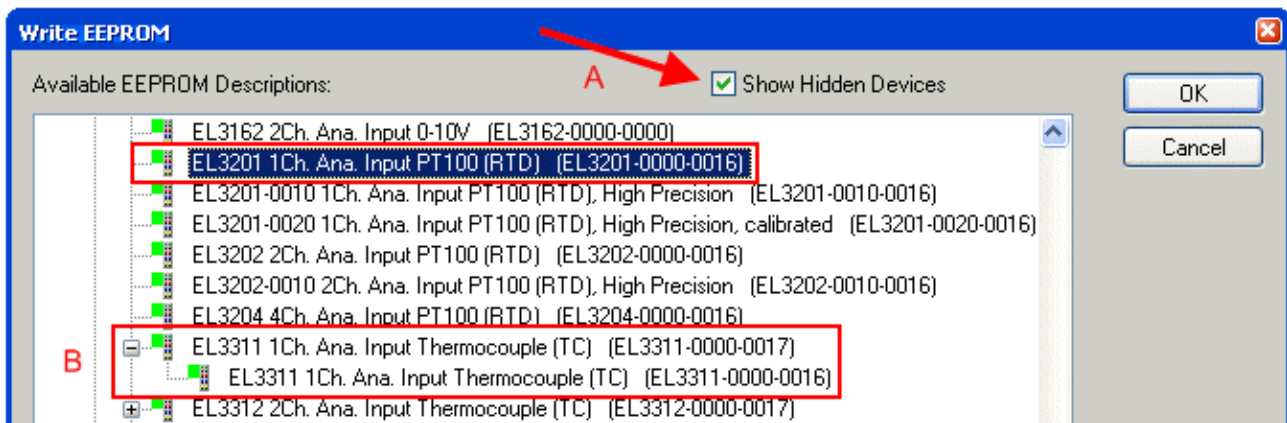

Fig. 235: Selecting the new ESI

A progress bar in the System Manager shows the progress. Data are first written, then verified.

i **The change only takes effect after a restart.**

Most EtherCAT devices read a modified ESI description immediately or after startup from the INIT. Some communication settings such as distributed clocks are only read during power-on. The EtherCAT slave therefore has to be switched off briefly in order for the change to take effect.

6.3.2 Firmware explanation

Determining the firmware version

Determining the version via the TwinCAT System Manager

The TwinCAT System Manager shows the version of the controller firmware if the master can access the slave online. Click on the E-Bus Terminal whose controller firmware you want to check (in the example terminal 2 (EL3204)) and select the tab *CoE Online* (CAN over EtherCAT).

i **CoE Online and Offline CoE**

Two CoE directories are available:

- **online:** This is offered in the EtherCAT slave by the controller, if the EtherCAT slave supports this. This CoE directory can only be displayed if a slave is connected and operational.
- **offline:** The EtherCAT Slave Information ESI/XML may contain the default content of the CoE. This CoE directory can only be displayed if it is included in the ESI (e.g. "Beckhoff EL5xxx.xml").

The Advanced button must be used for switching between the two views.

In Fig. *Display of EL3204 firmware version* the firmware version of the selected EL3204 is shown as 03 in CoE entry 0x100A.

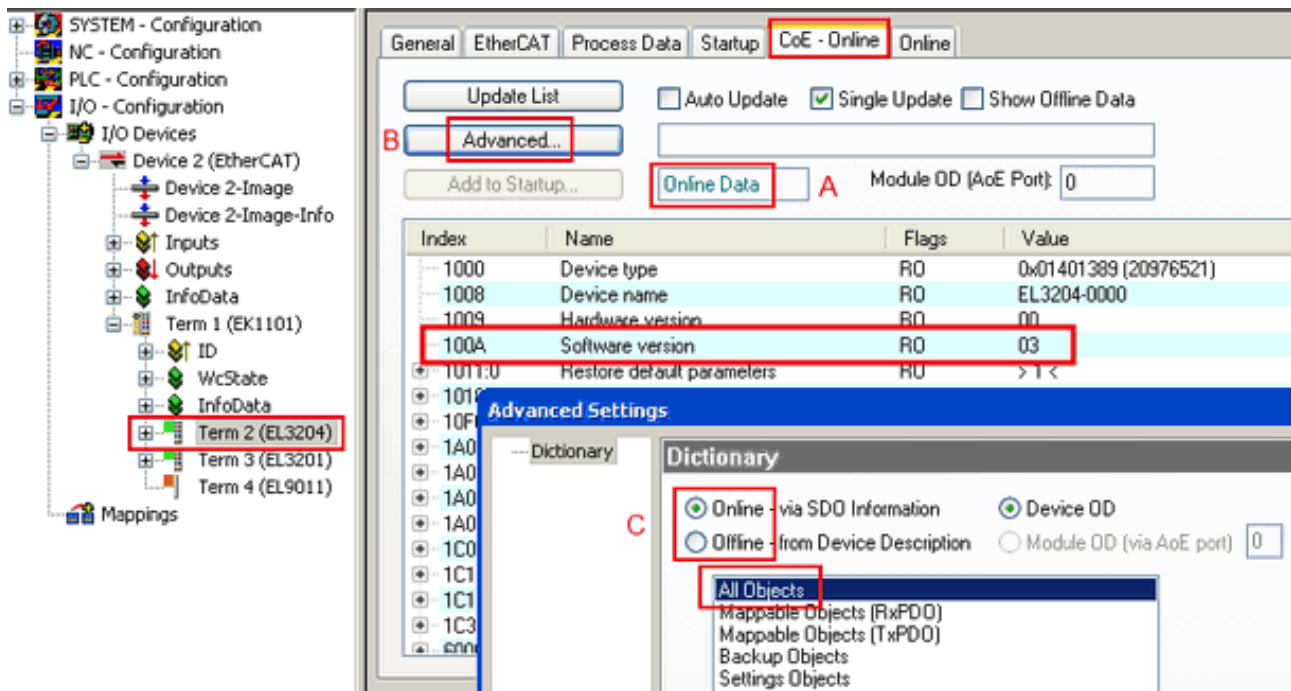

Fig. 236: Display of EL3204 firmware version

In (A) TwinCAT 2.11 shows that the Online CoE directory is currently displayed. If this is not the case, the Online directory can be loaded via the *Online* option in Advanced Settings (B) and double-clicking on *All Objects*.

6.3.3 Updating controller firmware *.efw

● CoE directory

i The Online CoE directory is managed by the controller and stored in a dedicated EEPROM, which is generally not changed during a firmware update.

Switch to the *Online* tab to update the controller firmware of a slave, see Fig. *Firmware Update*.

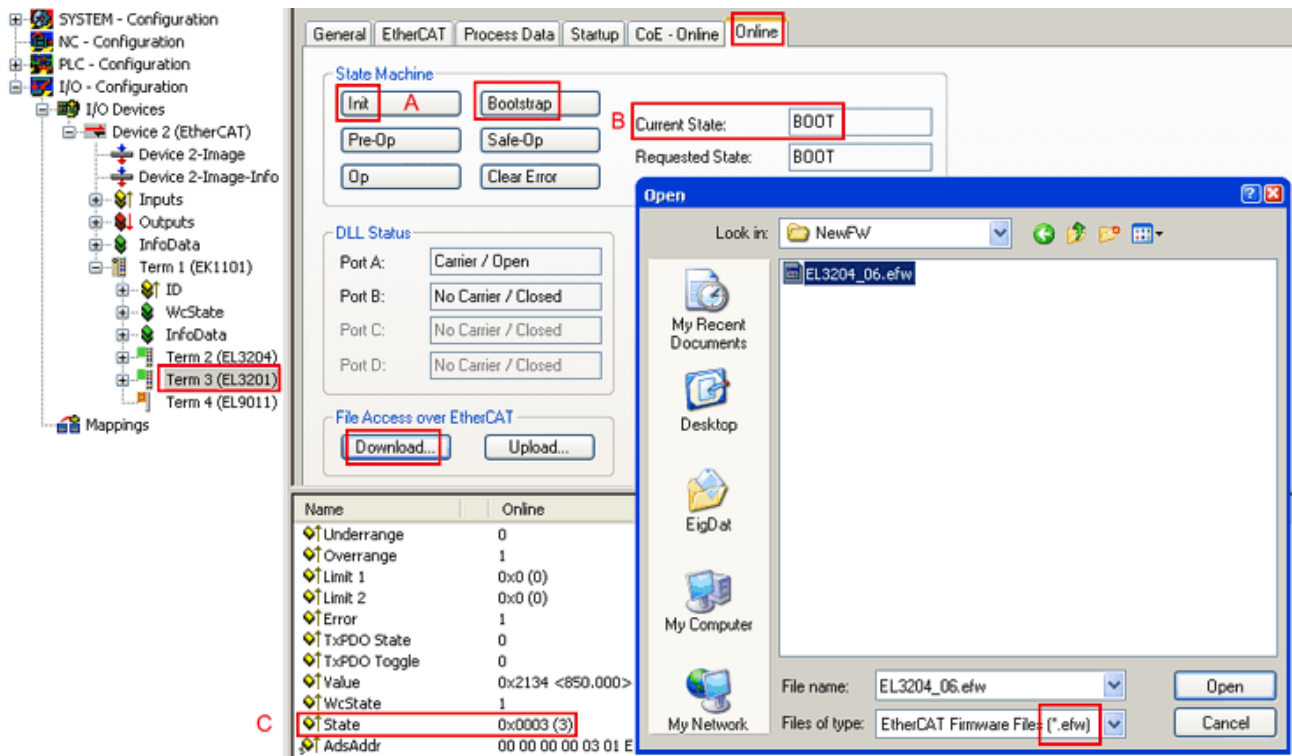
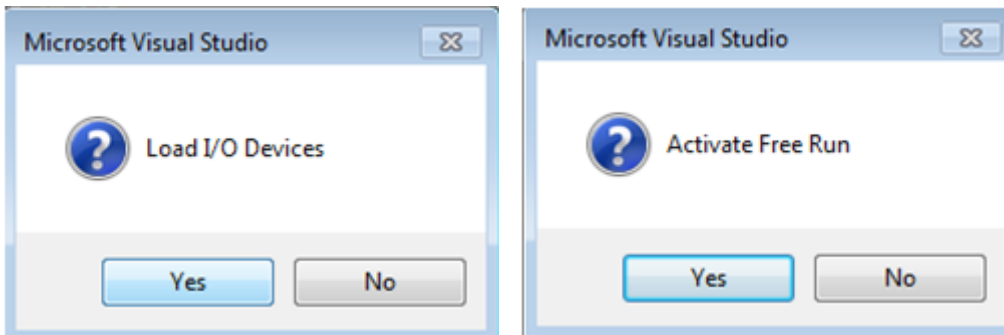

Fig. 237: Firmware Update

Proceed as follows, unless instructed otherwise by Beckhoff support. Valid for TwinCAT 2 and 3 as EtherCAT master.

- Switch TwinCAT system to ConfigMode/FreeRun with cycle time ≥ 1 ms (default in ConfigMode is 4 ms). A FW-Update during real time operation is not recommended.



- Switch EtherCAT Master to PreOP

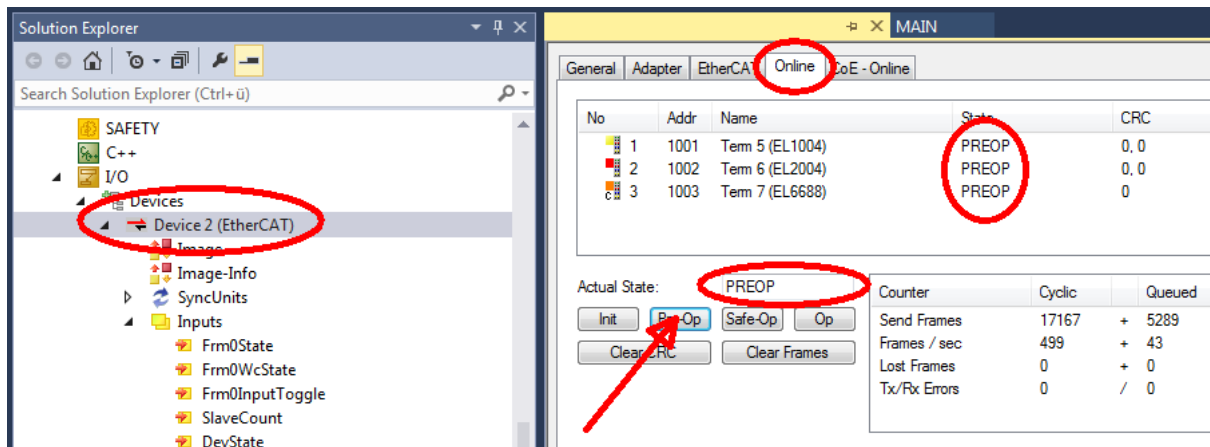

- Switch slave to INIT (A)
- Switch slave to BOOTSTRAP

- Check the current status (B, C)
- Download the new *efw file (wait until it ends). A password will not be necessary usually.

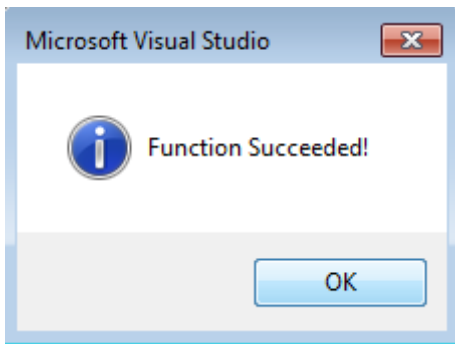

- After the download switch to INIT, then PreOP
- Switch off the slave briefly (don't pull under voltage!)
- Check within CoE 0x100A, if the FW status was correctly overtaken.

6.3.4 FPGA firmware *.rbf

If an FPGA chip deals with the EtherCAT communication an update may be accomplished via an *.rbf file.

- Controller firmware for processing I/O signals
- FPGA firmware for EtherCAT communication (only for terminals with FPGA)

The firmware version number included in the terminal serial number contains both firmware components. If one of these firmware components is modified this version number is updated.

Determining the version via the TwinCAT System Manager

The TwinCAT System Manager indicates the FPGA firmware version. Click on the Ethernet card of your EtherCAT strand (Device 2 in the example) and select the *Online* tab.

The *Reg:0002* column indicates the firmware version of the individual EtherCAT devices in hexadecimal and decimal representation.

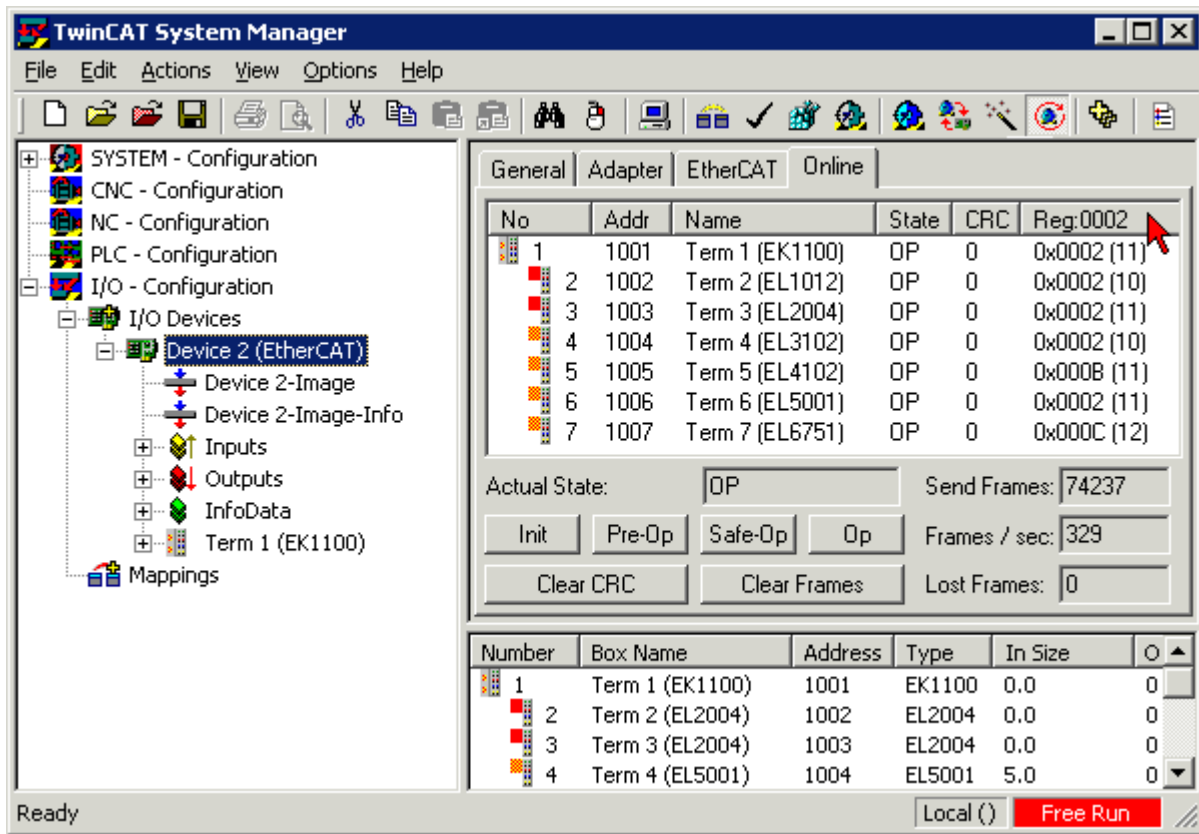

Fig. 238: FPGA firmware version definition

If the column *Reg:0002* is not displayed, right-click the table header and select *Properties* in the context menu.

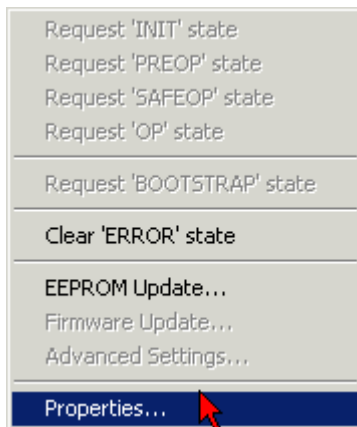

Fig. 239: Context menu *Properties*

The *Advanced Settings* dialog appears where the columns to be displayed can be selected. Under *Diagnosis/Online View* select the *'0002 ETxxxx Build'* check box in order to activate the FPGA firmware version display.

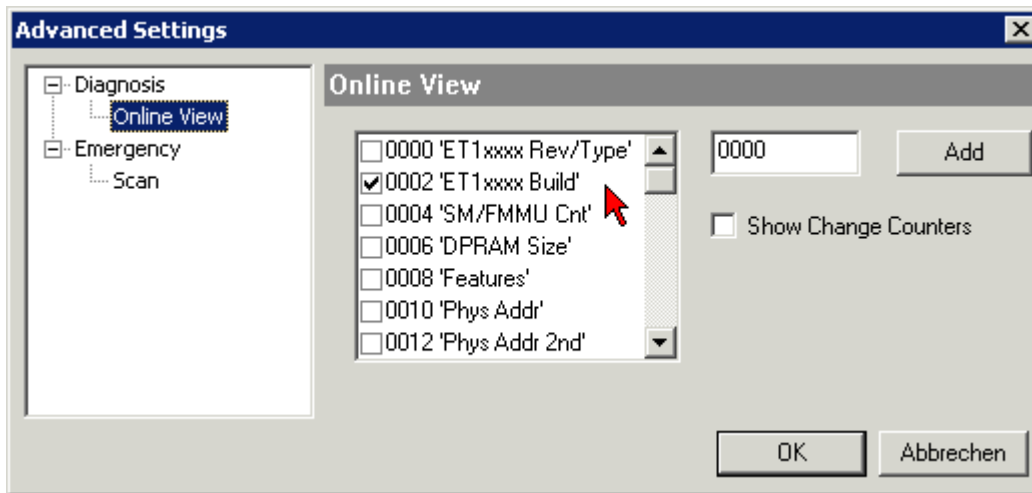

Fig. 240: Dialog *Advanced Settings*

Update

For updating the FPGA firmware

- of an EtherCAT coupler the coupler must have FPGA firmware version 11 or higher;
- of an E-Bus Terminal the terminal must have FPGA firmware version 10 or higher.

Older firmware versions can only be updated by the manufacturer!

Updating an EtherCAT device

The following sequence order have to be met if no other specifications are given (e.g. by the Beckhoff support):

- Switch TwinCAT system to ConfigMode/FreeRun with cycle time ≥ 1 ms (default in ConfigMode is 4 ms). A FW-Update during real time operation is not recommended.

- In the TwinCAT System Manager select the terminal for which the FPGA firmware is to be updated (in the example: Terminal 5: EL5001) and click the *Advanced Settings* button in the *EtherCAT* tab:

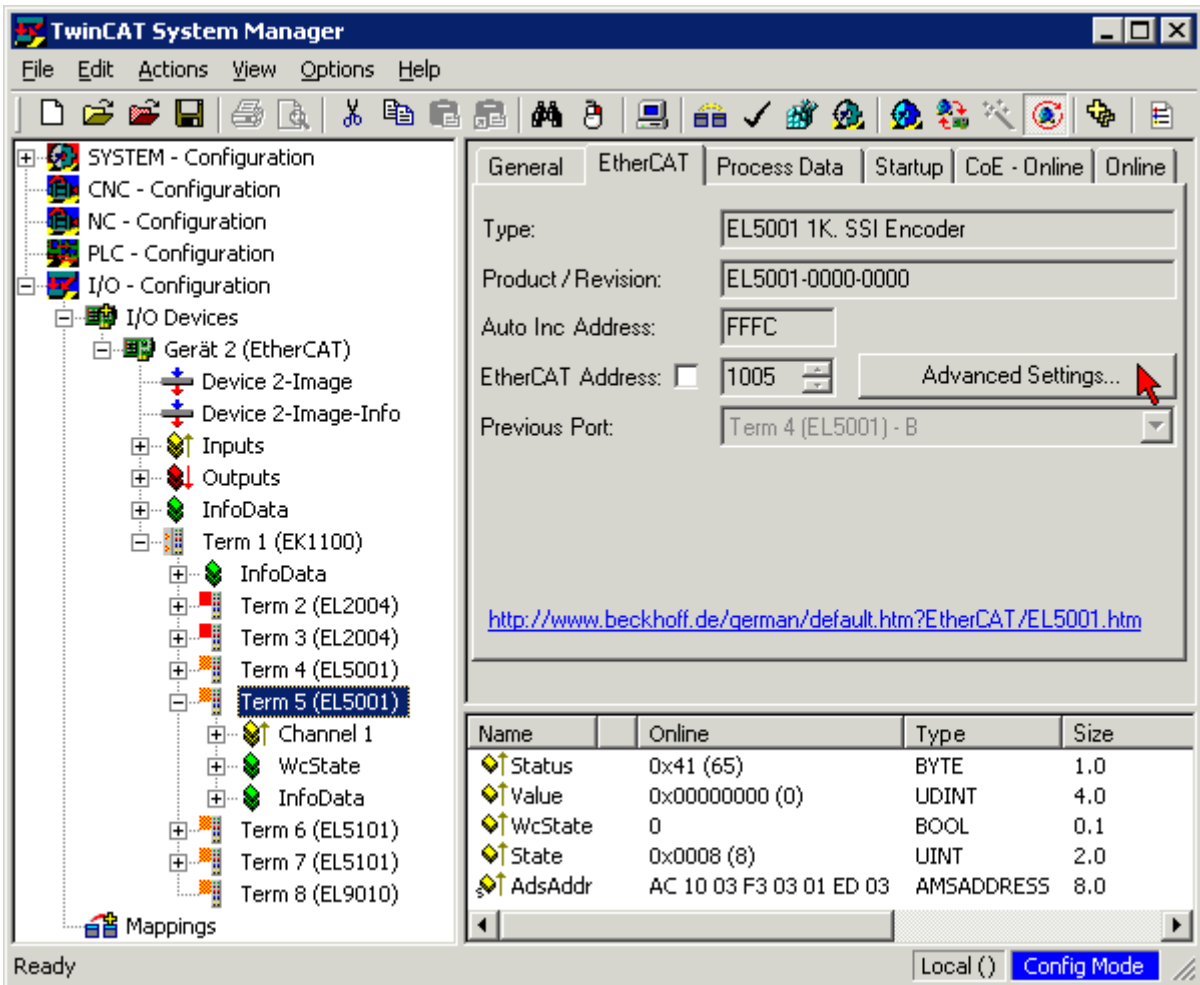

- The *Advanced Settings* dialog appears. Under *ESC Access/E²PROM/FPGA* click on *Write FPGA* button:

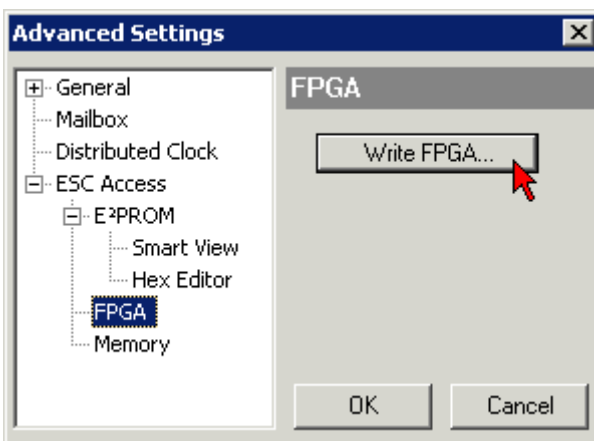

- Select the file (*.rbf) with the new FPGA firmware, and transfer it to the EtherCAT device:

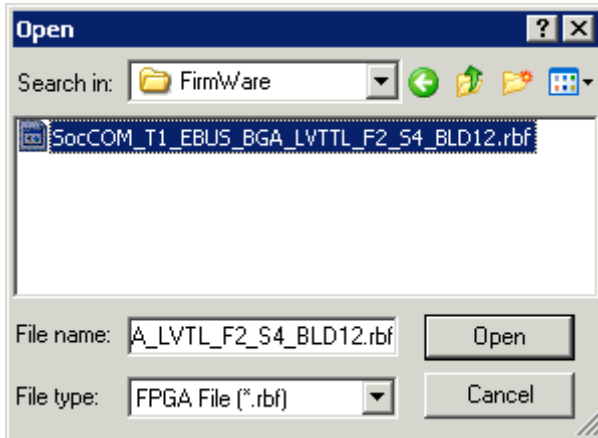

- Wait until download ends
- Switch slave current less for a short time (don't pull under voltage!). In order to activate the new FPGA firmware a restart (switching the power supply off and on again) of the EtherCAT device is required.
- Check the new FPGA status

NOTICE

Risk of damage to the device!

A download of firmware to an EtherCAT device must not be interrupted in any case! If you interrupt this process by switching off power supply or disconnecting the Ethernet link, the EtherCAT device can only be recommissioned by the manufacturer!

6.3.5 Simultaneous updating of several EtherCAT devices

The firmware and ESI descriptions of several devices can be updated simultaneously, provided the devices have the same firmware file/ESI.

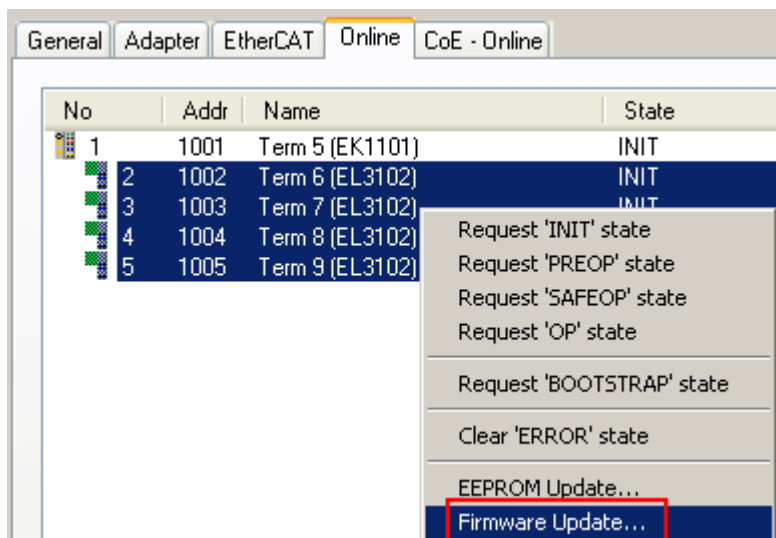

Fig. 241: Multiple selection and firmware update

Select the required slaves and carry out the firmware update in BOOTSTRAP mode as described above.

6.4 Restoring the delivery state

To restore the delivery state (factory settings) of CoE objects for EtherCAT devices (“slaves”), the CoE object *Restore default parameters*, SubIndex 001 can be used via EtherCAT master (e.g. TwinCAT) (see Fig. *Selecting the Restore default parameters PDO*).

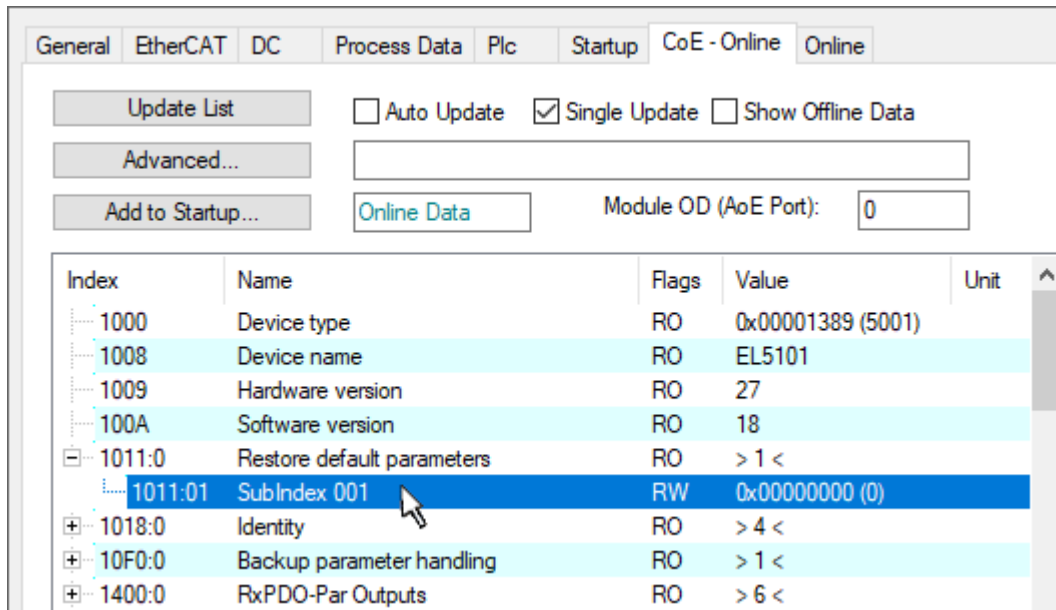

Fig. 242: Selecting the *Restore default parameters* PDO

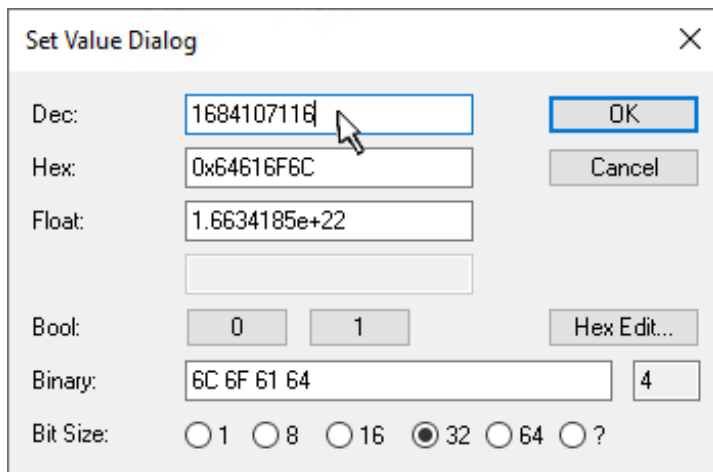

Fig. 243: Entering a restore value in the Set Value dialog

Double-click on *SubIndex 001* to enter the Set Value dialog. Enter the reset value **1684107116** in field *Dec* or the value **0x64616F6C** in field *Hex* (ASCII: “load”) and confirm with *OK* (Fig. *Entering a restore value in the Set Value dialog*).

- All changeable entries in the slave are reset to the default values.
- The values can only be successfully restored if the reset is directly applied to the online CoE, i.e. to the slave. No values can be changed in the offline CoE.
- TwinCAT must be in the RUN or CONFIG/Freerun state for this; that means EtherCAT data exchange takes place. Ensure error-free EtherCAT transmission.
- No separate confirmation takes place due to the reset. A changeable object can be manipulated beforehand for the purposes of checking.
- This reset procedure can also be adopted as the first entry in the startup list of the slave, e.g. in the state transition PREOP->SAFEOP or, as in Fig. *CoE reset as a startup entry*, in SAFEOP->OP.

All backup objects are reset to the delivery state.

i **Alternative restore value**

In some older terminals (FW creation approx. before 2007) the backup objects can be switched with an alternative restore value: Decimal value: 1819238756, Hexadecimal value: 0x6C6F6164.

An incorrect entry for the restore value has no effect.

6.5 Support and Service

Beckhoff and their partners around the world offer comprehensive support and service, making available fast and competent assistance with all questions related to Beckhoff products and system solutions.

Beckhoff's branch offices and representatives

Please contact your Beckhoff branch office or representative for local support and service on Beckhoff products!

The addresses of Beckhoff's branch offices and representatives round the world can be found on her internet pages: www.beckhoff.com

You will also find further documentation for Beckhoff components there.

Support

The Beckhoff Support offers you comprehensive technical assistance, helping you not only with the application of individual Beckhoff products, but also with other, wide-ranging services:

- support
- design, programming and commissioning of complex automation systems
- and extensive training program for Beckhoff system components

Hotline: +49 5246 963 157
e-mail: support@beckhoff.com
web: www.beckhoff.com/support

Service

The Beckhoff Service Center supports you in all matters of after-sales service:

- on-site service
- repair service
- spare parts service
- hotline service

Hotline: +49 5246 963 460
e-mail: service@beckhoff.com
web: www.beckhoff.com/service

Headquarters Germany

Beckhoff Automation GmbH & Co. KG

Hülshorstweg 20
33415 Verl
Germany

Phone: +49 5246 963 0
e-mail: info@beckhoff.com
web: www.beckhoff.com

More Information:
www.beckhoff.com/EL3xxx

Beckhoff Automation GmbH & Co. KG
Hülshorstweg 20
33415 Verl
Germany
Phone: +49 5246 9630
info@beckhoff.com
www.beckhoff.com

