

Documentation | EN

## EJ70x7

Stepper motor module with incremental encoder, vector control

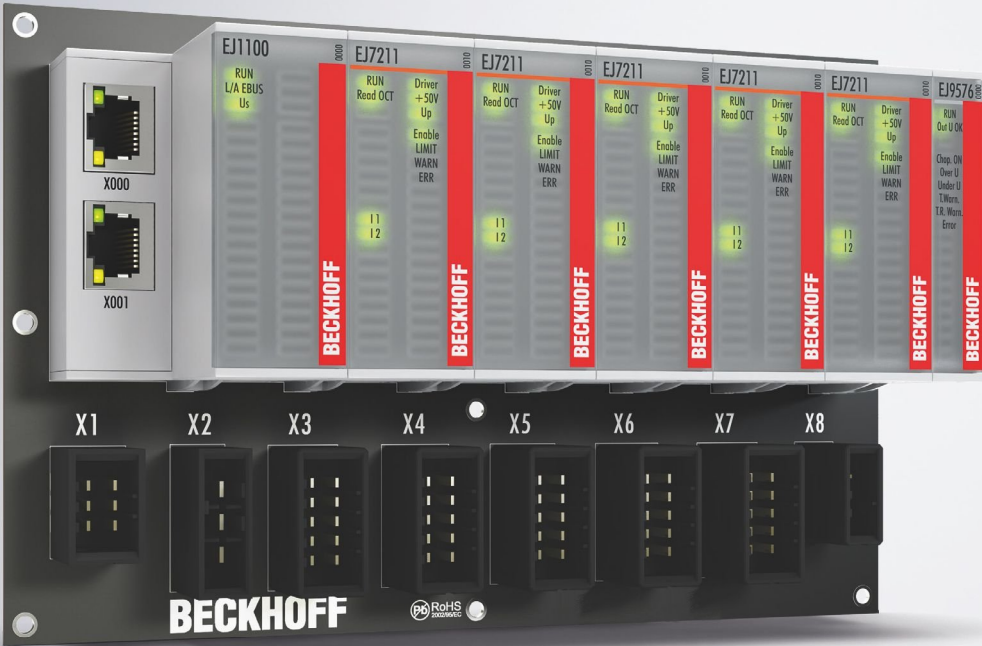



# Table of contents

<b>1 Foreword</b> .....	<b>5</b>
1.1 Product overview - stepper motor modules.....	5
1.2 Notes on the documentation .....	5
1.3 Safety instructions.....	6
1.4 Intended use .....	7
1.5 Signal distribution board.....	7
1.6 Documentation issue status .....	7
1.7 Guide through documentation.....	8
1.8 Marking of EtherCAT plug-in modules .....	8
1.8.1 Beckhoff Identification Code (BIC).....	11
1.8.2 Electronic access to the BIC (eBIC).....	13
1.8.3 Certificates .....	15
<b>2 System overview</b> .....	<b>16</b>
<b>3 EJ7037 - Product description</b> .....	<b>17</b>
3.1 Introduction .....	17
3.2 Technical data.....	18
3.3 Pinout .....	20
3.4 LEDs .....	21
<b>4 EJ7047 - Product description</b> .....	<b>22</b>
4.1 Introduction .....	22
4.2 Technical data.....	23
4.3 Pinout.....	25
4.4 LEDs .....	26
<b>5 Installation of EJ modules</b> .....	<b>27</b>
5.1 Power supply for the EtherCAT plug-in modules .....	27
5.2 Note on load voltage supply.....	28
5.3 EJxxxx - dimensions .....	29
5.4 Installation positions and minimum distances .....	30
5.4.1 Minimum distances for ensuring installability.....	30
5.4.2 Installation positions.....	31
5.5 Codings.....	33
5.5.1 Color coding .....	33
5.5.2 Mechanical position coding.....	34
5.6 Installation on the signal distribution board .....	34
5.7 Extension options.....	36
5.7.1 Using placeholder modules for unused slots .....	36
5.7.2 Linking with EtherCAT Terminals and EtherCAT Box modules via an Ethernet/EtherCAT connection.....	37
5.8 IPC integration .....	38
5.9 Disassembly of the signal distribution board.....	40
5.10 Disposal .....	40
<b>6 EtherCAT basics</b> .....	<b>41</b>
<b>7 EJ7037 - Commissioning</b> .....	<b>42</b>

7.1	Note on EL70x7 documentation .....	42
7.2	EJ7037 - Object description and parameterization .....	42
7.2.1	Restore object .....	43
7.2.2	Configuration data .....	43
7.2.3	Vendor configuration data (device-specific) .....	47
7.2.4	Command object .....	47
7.2.5	Input data .....	48
7.2.6	Output data .....	49
7.2.7	Information and diagnostic data .....	52
7.2.8	Standard objects (0x1000-0x1FFF) .....	54
<b>8</b>	<b>EJ7047 - Commissioning .....</b>	<b>67</b>
8.1	Note on EL70x7 documentation .....	67
8.2	EJ7047 - Object description and parameterization .....	67
8.2.1	Restore object .....	68
8.2.2	Configuration data .....	68
8.2.3	Vendor configuration data (device-specific) .....	72
8.2.4	Command object .....	72
8.2.5	Input data .....	73
8.2.6	Output data .....	74
8.2.7	Information and diagnostic data .....	77
8.2.8	Standard objects (0x1000-0x1FFF) .....	79
<b>9</b>	<b>Appendix .....</b>	<b>92</b>
9.1	Support and Service .....	92

# 1 Foreword

## 1.1 Product overview - stepper motor modules

<a href="#">EJ7037</a> [ <a href="#">▶ 17</a> ]	Stepper motor module 24 V <sub>DC</sub> , 1.5 A, with incremental encoder
<a href="#">EJ7047</a> [ <a href="#">▶ 22</a> ]	Stepper motor module 48 V <sub>DC</sub> , 5 A, with incremental encoder

## 1.2 Notes on the documentation

### Intended audience

This description is only intended for the use of trained specialists in control and automation engineering who are familiar with the applicable national standards.

It is essential that the documentation and the following notes and explanations are followed when installing and commissioning these components.

It is the duty of the technical personnel to use the documentation published at the respective time of each installation and commissioning.

The responsible staff must ensure that the application or use of the products described satisfy all the requirements for safety, including all the relevant laws, regulations, guidelines and standards.

### Disclaimer

The documentation has been prepared with care. The products described are, however, constantly under development.

We reserve the right to revise and change the documentation at any time and without prior announcement.

No claims for the modification of products that have already been supplied may be made on the basis of the data, diagrams and descriptions in this documentation.

### Trademarks

Beckhoff®, TwinCAT®, TwinCAT/BSD®, TC/BSD®, EtherCAT®, EtherCAT G®, EtherCAT G10®, EtherCAT P®, Safety over EtherCAT®, TwinSAFE®, XFC®, XTS® and XPlanar® are registered trademarks of and licensed by Beckhoff Automation GmbH. Other designations used in this publication may be trademarks whose use by third parties for their own purposes could violate the rights of the owners.

### Patent Pending

The EtherCAT Technology is covered, including but not limited to the following patent applications and patents: EP1590927, EP1789857, EP1456722, EP2137893, DE102015105702 with corresponding applications or registrations in various other countries.



EtherCAT® is registered trademark and patented technology, licensed by Beckhoff Automation GmbH, Germany.

### Copyright

© Beckhoff Automation GmbH & Co. KG, Germany.

The reproduction, distribution and utilization of this document as well as the communication of its contents to others without express authorization are prohibited.

Offenders will be held liable for the payment of damages. All rights reserved in the event of the grant of a patent, utility model or design.

## 1.3 Safety instructions

### Safety regulations

Please note the following safety instructions and explanations!  
Product-specific safety instructions can be found on following pages or in the areas mounting, wiring, commissioning etc.

### Exclusion of liability

All the components are supplied in particular hardware and software configurations appropriate for the application. Modifications to hardware or software configurations other than those described in the documentation are not permitted, and nullify the liability of Beckhoff Automation GmbH & Co. KG.

### Personnel qualification

This description is only intended for trained specialists in control, automation and drive engineering who are familiar with the applicable national standards.

### Description of instructions

In this documentation the following instructions are used.  
These instructions must be read carefully and followed without fail!

#### **DANGER**

##### **Serious risk of injury!**

Failure to follow this safety instruction directly endangers the life and health of persons.

#### **WARNING**

##### **Risk of injury!**

Failure to follow this safety instruction endangers the life and health of persons.

#### **CAUTION**

##### **Personal injuries!**

Failure to follow this safety instruction can lead to injuries to persons.

#### **NOTICE**

##### **Damage to environment/equipment or data loss**

Failure to follow this instruction can lead to environmental damage, equipment damage or data loss.

#### **Tip or pointer**

**i** This symbol indicates information that contributes to better understanding.

## 1.4 Intended use

### ⚠ WARNING

#### Caution - Risk of injury!

EJ components may only be used for the purposes described below!

## 1.5 Signal distribution board

### NOTICE

#### Signal distribution board

Make sure that the EtherCAT plug-in modules are used only on a signal distribution board that has been developed and manufactured in accordance with the [Design Guide](#).

## 1.6 Documentation issue status

Version	Comment
1.5	<ul style="list-style-type: none"> <li>Chapter <i>Note on load voltage supply</i> added</li> <li>Update structure</li> </ul>
1.4	<ul style="list-style-type: none"> <li>Update Technical Data</li> <li>Update chapter <i>Pinout</i></li> <li>Update chapter <i>Installation of EJ modules</i></li> <li>Update structure</li> </ul>
1.3	<ul style="list-style-type: none"> <li>Update chapter <i>Marking of EtherCAT plug-in modules</i></li> <li>Update Technical Data</li> <li>Chapter <i>Disposal</i> added</li> <li>Update chapter <i>Object description and parameterization</i></li> <li>Update structure</li> </ul>
1.2	<ul style="list-style-type: none"> <li>New Title page</li> <li>EJ7037 added</li> <li>Update Technical data</li> <li>Update chapter <i>Pinout</i></li> <li>Chapters <i>Basics communication</i>, <i>TwinCAT Quick Start</i>, <i>TwinCAT development environment</i> and <i>General Notes - EtherCAT Slave Application</i> replaced by references in the chapter <i>Guide through documentation</i></li> <li>Chapter <i>EJ7047 – Object description and parameterization</i> added</li> <li>Update revision status</li> <li>Update structure</li> </ul>
1.1	<ul style="list-style-type: none"> <li>Note <i>Signal Distribution Board</i> added</li> <li>Chapter <i>Version identification of EtherCAT devices</i> replaced by <i>Marking of EtherCAT plug-in modules</i></li> <li>Update Technical data</li> <li>Update chapter <i>Connection</i></li> </ul>
1.0	<ul style="list-style-type: none"> <li>1<sup>st</sup> publication EJ7047</li> </ul>

## 1.7 Guide through documentation

### NOTICE



#### Further components of documentation

This documentation describes device-specific content. It is part of the modular documentation concept for Beckhoff I/O components. For the use and safe operation of the device / devices described in this documentation, additional cross-product descriptions are required, which can be found in the following table.

Title	Description
<b>EtherCAT System Documentation</b> ( <a href="#">PDF</a> )	<ul style="list-style-type: none"> <li>• System overview</li> <li>• EtherCAT basics</li> <li>• Cable redundancy</li> <li>• Hot Connect</li> <li>• EtherCAT devices configuration</li> </ul>
<b>Design Guide EJ8xxx - Signal distribution board for standard EtherCAT plug-in modules</b> ( <a href="#">PDF</a> )	<p>Notes on the design of a signal distribution board for standard EtherCAT plug-in modules.</p> <ul style="list-style-type: none"> <li>• Requirements for the signal distribution board</li> <li>• Backplane mounting guidelines</li> <li>• Module placement</li> <li>• Routing guidelines</li> </ul>
<b>Documentation of the corresponding ELxxxx EtherCAT Terminal</b> (s. <a href="#">note on documentation of ELxxxx</a> ) [ <a href="#">▶ 42</a> ]	<ul style="list-style-type: none"> <li>• Notes on the principle of operation and</li> <li>• descriptions for configuration and parameterization are transferable to the corresponding EtherCAT plug-in modules</li> </ul>
<b>Infrastructure for EtherCAT/Ethernet</b> ( <a href="#">PDF</a> )	Technical recommendations and notes for design, implementation and testing
<b>Software Declarations I/O</b> ( <a href="#">PDF</a> )	Open source software declarations for Beckhoff I/O components

The documentations can be viewed at and downloaded from the Beckhoff website ([www.beckhoff.com](http://www.beckhoff.com)) via:

- the “Documentation and Download” area of the respective product page,
- the [Download finder](#),
- the [Beckhoff Information System](#).

## 1.8 Marking of EtherCAT plug-in modules

### Designation

A Beckhoff EtherCAT device has a 14-digit **technical designation**, made up as follows (e.g. EJ1008-0000-0017)

- **Order identifier**
  - family key: EJ
  - product designation: The first digit of product designation is used for assignment to a product group (e.g. EJ2xxx = digital output module).
  - Version number: The four digit version number identifies different product variants.
- **Revision number:**  
It is incremented when changes are made to the product.

The Order identifier and the revision number are printed on the side of EtherCAT plug-in modules (s. following illustration (A and B)).



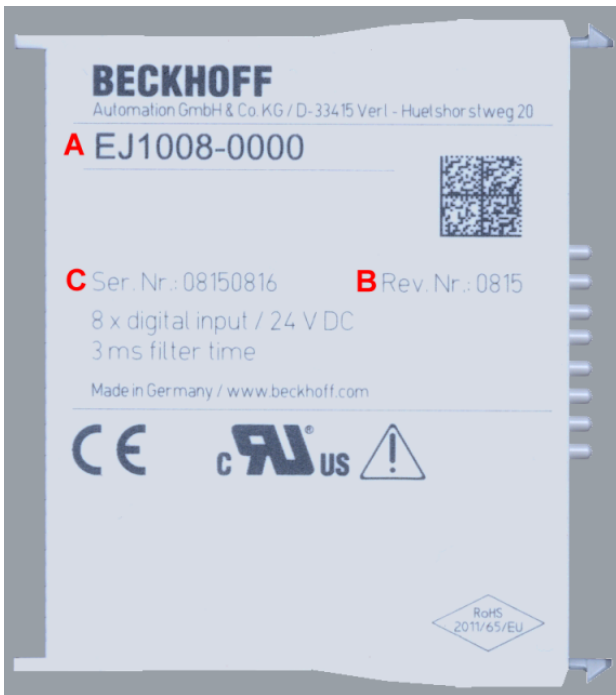

Fig. 1: Order identifier (A), Revision number (B) and serial number (C) using the example of EJ1008

Product group	Example		
	Product designation	Version	Revision
EtherCAT Coupler EJ11xx	EJ1101	-0022 (Coupler with external connectors, power supply module and optional ID switches)	-0016
Digital input modules EJ1xxx	EJ1008 8-channel	-0000 (basic type)	-0017
Digital output modules EJ2xxx	EJ2521 1-channel	-0224 (2 x 24 V outputs)	-0016
Analog input modules EJ3xxx	EJ3318 8-channel thermocouple	-0000 (basic type)	-0017
Analog output modules EJ4xxx	EJ4134 4-channel	-0000 (basic type)	-0019
Special function modules EJ5xxx, EJ6xxx	EJ6224 IO-Link master	-0090 (with TwinSAFE SC)	-0016
Motion modules EJ7xxx	EJ7211 servomotor	-9414 (with ECT, STO and TwinSAFE SC)	-0029

**Notes**

- The elements mentioned above result in the **technical designation**. EJ1008-0000-0017 is used in the example below.
- EJ1008-0000 is the **order identifier**, in the case of “-0000” usually abbreviated to EJ1008.
- The **revision** -0017 shows the technical progress, such as the extension of features with regard to the EtherCAT communication, and is managed by Beckhoff.  
In principle, a device with a higher revision can replace a device with a lower revision, unless specified otherwise, e.g. in the documentation.  
Associated and synonymous with each revision there is usually a description (ESI, EtherCAT Slave Information) in the form of an XML file, which is available for [download](#) from the Beckhoff web site.
- The product designation, version and revision are read as decimal numbers, even if they are technically saved in hexadecimal.

**Serial number**

The serial number for EtherCAT plug-in modules is usually the 8-digit number printed on the side of the module (see following illustration C). The serial number indicates the configuration in delivery state and therefore refers to a whole production batch, without distinguishing the individual modules of a batch.

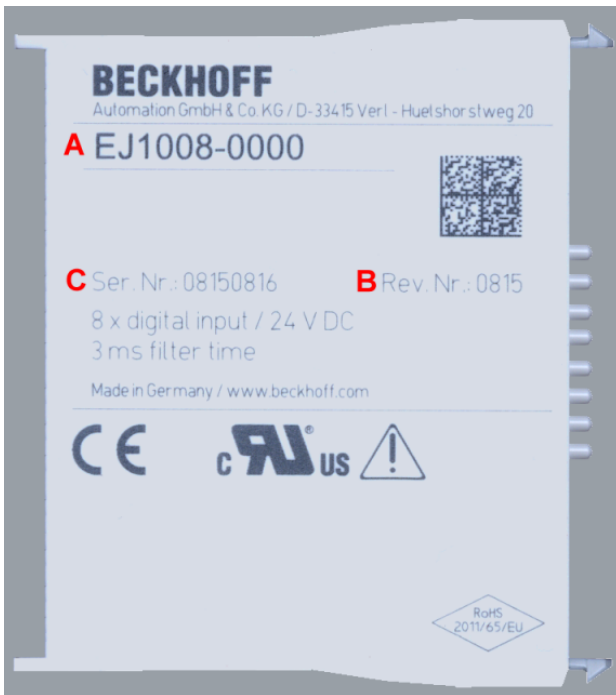

Fig. 2: Order identifier (A), revision number (B) and serial number (C) using the example of EJ1008

Serial number	Example serial number: 08 15 08 16
KK - week of production (CW, calendar week)	08 - week of production: 08
YY - year of production	15 - year of production: 2015
FF - firmware version	08 - firmware version: 08
HH - hardware version	16 - hardware version: 16

### 1.8.1 Beckhoff Identification Code (BIC)

The Beckhoff Identification Code (BIC) is increasingly being applied to Beckhoff products to uniquely identify the product. The BIC is represented as a Data Matrix Code (DMC, code scheme ECC200), the content is based on the ANSI standard MH10.8.2-2016.



Fig. 3: BIC as data matrix code (DMC, code scheme ECC200)

The BIC will be introduced step by step across all product groups.

Depending on the product, it can be found in the following places:

- on the packaging unit
- directly on the product (if space suffices)
- on the packaging unit and the product

The BIC is machine-readable and contains information that can also be used by the customer for handling and product management.

Each piece of information can be uniquely identified using the so-called data identifier (ANSI MH10.8.2-2016). The data identifier is followed by a character string. Both together have a maximum length according to the table below. If the information is shorter, it shall be replaced by spaces. The data under positions 1-4 are always available.

The following information is contained:

Item no.	Type of information	Explanation	Data identifier	Number of digits incl. data identifier	Example
1	Beckhoff order number	<b>Beckhoff order number</b>	1P	8	<b>1P</b> 072222
2	Beckhoff Traceability Number (BTN)	<b>Unique serial number, see note below</b>	S	12	<b>SBTNk4p562d7</b>
3	Article description	<b>Beckhoff article description, e.g. EL1008</b>	1K	32	<b>1KEL</b> 1809
4	Quantity	<b>Quantity in packaging unit, e.g. 1, 10, etc.</b>	Q	6	<b>Q1</b>
5	Batch number	Optional: Year and week of production	2P	14	<b>2P</b> 401503180016
6	ID/serial number	Optional: Present-day serial number system, e.g. with safety products	51S	12	<b>51S</b> 678294104
7	Variant number	Optional: Product variant number on the basis of standard products	30P	32	<b>30P</b> F971 , 2*K183
...					

Further types of information and data identifiers are used by Beckhoff and serve internal processes.

### Structure of the BIC

Example of composite information from items 1 - 4 and with the above given example value on position 6. The data identifiers are marked in bold font for better display:

**1P**072222**SBTNk4p562d7****1KEL**1809 **Q1** **51S**678294

Accordingly as DMC:



Fig. 4: Example DMC **1P072222SBTNk4p562d71KEL1809 Q1 51S678294**

### BTN

An important component of the BIC is the Beckhoff Traceability Number (BTN, item no. 2). The BTN is a unique serial number consisting of eight characters that will replace all other serial number systems at Beckhoff in the long term (e.g. batch designations on IO components, previous serial number range for safety products, etc.). The BTN will also be introduced step by step, so it may happen that the BTN is not yet coded in the BIC.

### NOTICE

This information has been carefully prepared. However, the procedure described is constantly being further developed. We reserve the right to revise and change procedures and documentation at any time and without prior notice. No claims for changes can be made from the information, illustrations and descriptions in this information.

## 1.8.2 Electronic access to the BIC (eBIC)

### Electronic BIC (eBIC)

The Beckhoff Identification Code (BIC) is applied to the outside of Beckhoff products in a visible place. If possible, it should also be electronically readable.

Decisive for the electronic readout is the interface via which the product can be electronically addressed.

### K-bus devices (IP20, IP67)

Currently, no electronic storage and readout is planned for these devices.

### EtherCAT devices (IP20, IP67)

All Beckhoff EtherCAT devices have a so-called ESI-EEPROM, which contains the EtherCAT identity with the revision number. Stored in it is the EtherCAT slave information, also colloquially known as ESI/XML configuration file for the EtherCAT master. See the corresponding chapter in the EtherCAT system manual ([Link](#)) for the relationships.

The eBIC is also stored in the ESI-EEPROM. The eBIC was introduced into the Beckhoff I/O production (terminals, box modules) from 2020; widespread implementation is expected in 2021.

The user can electronically access the eBIC (if existent) as follows:

- With all EtherCAT devices, the EtherCAT master (TwinCAT) can read the eBIC from the ESI-EEPROM
  - From TwinCAT 3.1 build 4024.11, the eBIC can be displayed in the online view.
  - To do this, check the checkbox "Show Beckhoff Identification Code (BIC)" under EtherCAT → Advanced Settings → Diagnostics:

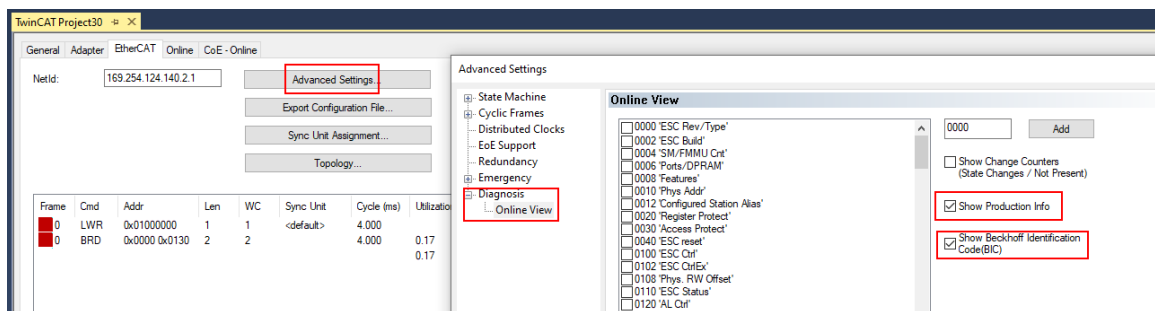

- The BTN and its contents are then displayed:

No	Addr	Name	State	CRC	Fw	Hw	Production Data	ItemNo	BTN	Description	Quantity	BatchNo	SerialNo
1	1001	Term 1 (EK1100)	OP	0,0	0	0	—	—	—	—	—	—	—
2	1002	Term 2 (EL1018)	OP	0,0	0	0	2020 KW36 Fr	072222	k4p562d7	EL1809	1	—	678294
3	1003	Term 3 (EL3204)	OP	0,0	7	6	2012 KW24 Sa	—	—	—	—	—	—
4	1004	Term 4 (EL2004)	OP	0,0	0	0	—	072223	k4p562d7	EL2004	1	—	678295
5	1005	Term 5 (EL1008)	OP	0,0	0	0	—	—	—	—	—	—	—
6	1006	Term 6 (EL2008)	OP	0,0	0	12	2014 KW14 Mo	—	—	—	—	—	—
7	1007	Term 7 (EK1110)	OP	0	1	8	2012 KW25 Mo	—	—	—	—	—	—

- Note: as can be seen in the illustration, the production data HW version, FW version and production date, which have been programmed since 2012, can also be displayed with "Show Production Info".
- From TwinCAT 3.1. build 4024.24 the functions *FB\_EcReadBIC* and *FB\_EcReadBTN* for reading into the PLC and further eBIC auxiliary functions are available in the Tc2\_EtherCAT Library from v3.3.19.0.
- In the case of EtherCAT devices with CoE directory, the object 0x10E2:01 can additionally be used to display the device's own eBIC; the PLC can also simply access the information here:

- The device must be in PREOP/SAFEOP/OP for access:

Index	Name	Flags	Value
1000	Device type	RO	0x015E1389 (22942601)
1008	Device name	RO	ELM3704-0000
1009	Hardware version	RO	00
100A	Software version	RO	01
100B	Bootloader version	RO	J0.1.27.0
1011:0	Restore default parameters	RO	> 1 <
1018:0	Identity	RO	> 4 <
10E2:0	Manufacturer-specific Identification C...	RO	> 1 <
10E2:01	SubIndex 001	RO	1P158442SBTN0008jekp1KELM3704 Q1 2P482001000016
10F0:0	Backup parameter handling	RO	> 1 <
10F3:0	Diagnosis History	RO	> 21 <
10F8	Actual Time Stamp	RO	0x170fb277e

- the object 0x10E2 will be introduced into stock products in the course of a necessary firmware revision.
- From TwinCAT 3.1. build 4024.24 the functions *FB\_EcCoEReadBIC* and *FB\_EcCoEReadBTN* for reading into the PLC and further eBIC auxiliary functions are available in the *Tc2\_EtherCAT Library* from v3.3.19.0.
- Note: in the case of electronic further processing, the BTN is to be handled as a string(8); the identifier "SBTN" is not part of the BTN.
- Technical background  
The new BIC information is additionally written as a category in the ESI-EEPROM during the device production. The structure of the ESI content is largely dictated by the ETG specifications, therefore the additional vendor-specific content is stored with the help of a category according to ETG.2010. ID 03 indicates to all EtherCAT masters that they must not overwrite these data in case of an update or restore the data after an ESI update.  
The structure follows the content of the BIC, see there. This results in a memory requirement of approx. 50..200 bytes in the EEPROM.
- Special cases
  - If multiple, hierarchically arranged ESCs are installed in a device, only the top-level ESC carries the eBIC Information.
  - If multiple, non-hierarchically arranged ESCs are installed in a device, all ESCs carry the eBIC Information.
  - If the device consists of several sub-devices with their own identity, but only the top-level device is accessible via EtherCAT, the eBIC of the top-level device is located in the CoE object directory 0x10E2:01 and the eBICs of the sub-devices follow in 0x10E2:nn.

### PROFIBUS, PROFINET, DeviceNet devices etc.

Currently, no electronic storage and readout is planned for these devices.

### 1.8.3 Certificates

- The EtherCAT plug-in modules meet the requirements of the EMC and Low Voltage Directive. The CE mark is printed on the side of the modules.
- The cRUus imprint identifies devices that meet product safety requirements according to U.S. and Canadian regulations.
- The warning symbol is a request to read the corresponding documentation. The documentations for EtherCAT plug-in modules can be downloaded from the Beckhoff [homepage](#).



Fig. 5: Marking for CE and UL using EJ1008 as an example

## 2 System overview

Electronically, the EJxxxx EtherCAT plug-in modules are based on the EtherCAT I/O system. The EJ system consists of the signal distribution board and EtherCAT plug-in modules. It is also possible to connect an IPC to the EJ system.

The EJ system is suitable for mass production applications, applications with small footprint and applications requiring a low total weight.

The machine complexity can be extended by means of the following:

- reserve slots,
- the use of placeholder modules,
- linking of EtherCAT Terminals and EtherCAT Boxes via an EtherCAT connection.

The following diagram illustrates an EJ system. The components shown are schematic, to illustrate the functionality.

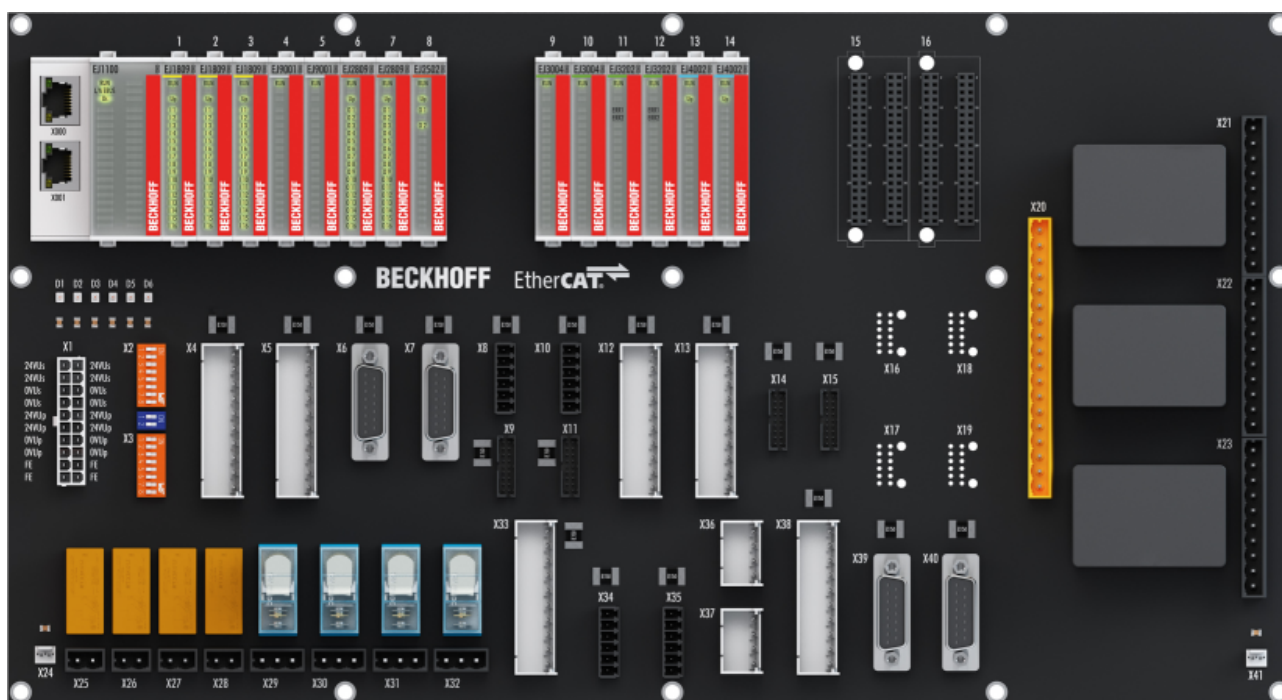

Fig. 6: EJ system sample

### Signal distribution board

The signal distribution board distributes the signals and the power supply to individual application-specific plug connectors, in order to connect the controller to further machine modules. Using pre-assembled cable harnesses avoids the need for time-consuming connection of individual wires. Coded components reduce the unit costs and the risk of miswiring.

Beckhoff offers development of signal distribution boards as an engineering service. Customers have the option to develop their own signal distribution board, based on the design guide.

### EtherCAT plug-in modules

Similar to the EtherCAT Terminal system, a module strand consists of a bus coupler and I/O modules. Almost all of the EtherCAT Terminals can also be manufactured in the EJ design as EtherCAT plug-in modules. The EJ modules are directly attached to the signal distribution board. The communication, signal distribution and supply take place via the contact pins at the rear of the modules and the PCB tracks of the signal distribution board. The coding pins at the rear serve as mechanical protection against incorrect connection. Color coding on the housing facilitates distinguishing of the modules.



## 3 EJ7037 - Product description

### 3.1 Introduction

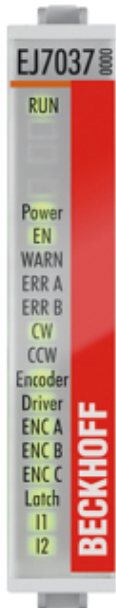

Fig. 7: EJ7037

#### **Stepper motor terminal, 24 V<sub>DC</sub>, 1.5 A, with incremental encoder, vector control**

The EJ7037 stepper motor module is designed for the direct connection of stepper motors in the medium power range up to 1.5 A. The compact stepper motor output stage is accommodated in the EtherCAT plug-in module together with two digital inputs for limit switches.

The EJ7037 can be adapted to the motor to be operated and the application requirements through parameterization. A particularly smooth and precise motor run is ensured by 64-fold microstepping.

In combination with a corresponding stepper motor, the EJ7037 represents a cost-effective compact drive solution. With its torsion-proof, integrated encoder (1024 inc/rev), the AS2000 stepper motor is ideal for the closed-loop control of the EJ7037.

## 3.2 Technical data

Technical data	EJ7037
Technology	Compact Drive Technology
Connection method	direct motor connection + feedback
Number of inputs	2 x end position, 1 x encoder
Load type	2-phase stepper motors (uni- or bipolar)
Number of channels	1
Number of outputs	1 stepper motor, 1 x motor brake
Supply voltage electronics	24 V <sub>DC</sub> (-15% / +20%) (via distribution board)
Supply voltage power	24 V <sub>DC</sub> (via distribution board)
Output current max.	1.5 A (overload- and short-circuit-proof)
Operating modes	Standard mode (velocity direct / position controller) Field-oriented control (extended velocity mode / extended position mode) Sensorless operation Travel distance control (positioning interface)
Maximum step frequency	1000, 2000, 4000, 8000 or 16000 full steps/s (configurable)
Step pattern	64-fold micro stepping (automatic switching, speed-dependent)
Current controller frequency	approx. 30 kHz
Encoder pulse frequency	maximum 400,000 increments/s (4-fold evaluation)
Encoder input signal	5 V <sub>DC</sub> ... 24 V <sub>DC+</sub> , single-ended
Input current	typ. 5 mA
Resolution	approx. 5,000 positions in typical applications (per revolution)
Current consumption from the E-bus	typ. 140 mA
Current consumption load voltage (Up contacts)	typ. 70 mA (via distribution board)
Distributed clocks (DC)	yes
Electrical isolation	500 V (E-bus/signal voltage)
Special features	Travel distance control, encoder input, vector control
Support NoCoEStorage	yes
Permissible ambient temperature range during operation	0°C ... +55°C
Permissible ambient temperature range during storage	-25°C ... + 85°C
Permissible relative humidity	95 %, no condensation
Operation altitude	max. 2.000 m
Dimensions (W x H x D)	approx. 12 mm x 66 mm x 55 mm
Weight	approx. 30 g
Installation	on signal distribution board
Pollution degree	2
Installation position	Standard see <a href="#">note [► 31]!</a>
Position of coding pins [► 34]	1 and 8
Color coding	orange
Vibration/shock resistance	conforms to EN 60068-2-6 / EN 60068-2-27 (with corresponding signal distribution board)
EMC immunity/emission	according to EN 61000-6-2 / EN 61000-6-4 (with corresponding signal distribution board) according to IEC/EN 61800-3 (with corresponding signal distribution board)
EMC category	category C3 - standard category C2, C1 - auxiliary filter required
Protection class	EJ module: IP20 EJ system: dependent on signal distribution board and housing
Approvals/markings*	CE, EAC, UKCA

\*) Real applicable approvals/markings see type plate on the side (product marking).



### CE approval

The CE Marking refers to the EtherCAT plug-in module mentioned above. If the EtherCAT plug-in module is used in the production of a ready-to-use end product (PCB in conjunction with a housing), the manufacturer of the end product must check compliance of the overall system with relevant directives and CE certification. To operate the EtherCAT plug-in modules, they must be installed in a housing.

**UL notice - Compact Motion**

---

**● Notes on motion devices****• *Motor overtemperature***

Motor overtemperature sensing is not provided by the drive.

**• *Application for compact motion devices***

The modules are intended for use only within Beckhoff's Programmable Controller system Listed in File E172151.

**• *Galvanic isolation from the supply***

The modules are intended for operation within circuits not connected directly to the supply mains (galvanically isolated from the supply, i.e. on transformer secondary).

**• *Requirements for environmental conditions***

For use in Pollution Degree 2 Environment only.

---

### 3.3 Pinout

EJ7037			
Pin#		Signal	
1	2	U <sub>EBUS</sub>	U <sub>EBUS</sub>
3	4	GND	GND
5	6	RX0+	TX1+
7	8	RX0-	TX1-
9	10	GND	GND
11	12	TX0+	RX1+
13	14	TX0-	RX1-
15	16	GND	GND
17	18	MotorA A1	MotorA A1
19	20	MotorA A2	MotorA A2
21	22	MotorA B1	MotorA B1
23	24	MotorA B2	MotorA B2
25	26	EncA A	DI 1
27	28	EncA B	DI 2
29	30	GND Sensor	24V Sensor
31	32	EncA C	Latch
33	34	0V Up	0V Up
35	36	0V Up	24V Up
37	38	24V Up	24V Up
39	40	SGND	SGND

**E-Bus contacts**  
The power supply U<sub>EBUS</sub> is provided by the coupler and supplied from the supply voltage U<sub>S</sub> of the EtherCAT coupler.

**Signals and power supply of the sensor**

**U<sub>P</sub>-Contacts**  
The peripheral voltage U<sub>P</sub> supplies the electronics on the field side.

Signal	Description
U <sub>EBUS</sub>	E-Bus power supply 3.3 V
GND	E-Bus GND signal. Don't connect with 0V Up!
RXn+	Positive E-Bus receive signal
RXn-	Negative E-Bus receive signal
TXn+	Positive E-Bus transmit signal
TXn-	Negative E-Bus transmit signal
MotorA A1	Motor winding A
MotorA A2	Motor winding A
MotorA B1	Motor winding B
MotorA B2	Motor winding B
EncA A	Encoder-Input A
EncA B	Encoder-Input B
GND Sensor	0 V encoder supply
24V Sensor	24 V encoder supply
EncA C	Encoder-Input C
Latch	Latch Input
DI 1 ... DI2	Digital Input 1 ... 2
0V Up	Field side GND signal
24V Up	Field side power supply 24 V
SGND	Shield Ground

Fig. 8: EJ7037 - Pinout

The PCB footprint can be downloaded from Beckhoff [homepage](#).

NOTICE	
	<p><b>Damage to devices possible!</b></p> <p>Before installation and commissioning read the chapters <a href="#">Installation of EJ modules [► 27]</a> and <a href="#">Commissioning [► 42]!</a></p>



#### Shielding

Feedback signal, sensors and actuators should always be connected with shielded, twisted paired wires.

### 3.4 LEDs

LED No.	EJ7037
A	RUN
B	
C	
1	
2	Power
3	EN
4	WARN
5	ERR A
6	ERR B
7	CW
8	CCW
9	Encoder
10	Driver
11	ENC A
12	ENC B
13	ENC C
14	Latch
15	I 1
16	I 2

Fig. 9: EJ7037 - LEDs

LED	Color	Display	State	Meaning
RUN	green	off	Init	State of the EtherCAT State Machine: <b>INIT</b> = Initialization of the terminal or <b>BOOTSTRAP</b> = Function for firmware updates of the terminal
		blinking	Pre-Operational	State of the EtherCAT State Machine: <b>PREOP</b> = Setting for mailbox communication and variant standard settings
		single flash	Safe-Operational	State of the EtherCAT State Machine: <b>SAFEOP</b> = Channel checking of the <u>Sync-Manager</u> and the Distributed Clocks. Outputs stay in safe operation mode.
		on	Operational	State of the EtherCAT State Machine: <b>OP</b> = Normal operation mode, mailbox- and process data communication possible
		flickering	Bootstrap	State of the EtherCAT State Machine: <b>BOOTSTRAP</b> = function for <u>firmware updates</u> of the plug-in module
Power	green	off		The power supply voltage (24 V <sub>DC</sub> ) is absent or the motor control is blocked (Index 0x6010:02 is not set)
		on		The power supply voltage (24 V <sub>DC</sub> ) is present
EN	green	off		The motor control is blocked (Index 0x6010:02 is not set) or EJ7037 is not ready for operation.
		on		The motor control is activated (Index 0x6010:02 is set) or EJ7037 is ready for operation.
WARN	yellow	off		No errors
		on		Configuration error, e.g.: <ul style="list-style-type: none"> <li>• Motor power supply not connected</li> <li>• 80°C temperature exceeded</li> <li>• 100% duty cycle reached</li> <li>• ...</li> </ul>
ERR A ERR B	red	on		Configuration error of output stage A or B, e.g.: <ul style="list-style-type: none"> <li>• 100°C temperature exceeded</li> <li>• short circuit</li> <li>• ...</li> </ul>
CW	green	on		Motor is triggered clockwise
CCW	green	on		Motor is triggered counter clockwise
Encoder	green	on		Encoder ready for operation
Driver	green	on		Driver stage ready for operation
ENC A/B/C	green	on		Signal at encoder input A/B/C
Latch	green	on		Signal at latch input
I 1	green	on		Signal at digital input 1
I 2	green	on		Signal at digital input 2

## 4 EJ7047 - Product description

### 4.1 Introduction

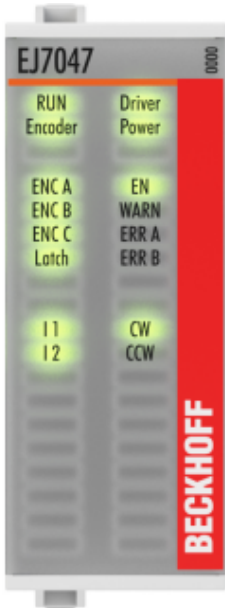

Fig. 10: EJ7047

#### **Stepper motor terminal, 48 V<sub>DC</sub>, 5 A, with incremental encoder, vector control**

The EJ7047 EtherCAT plug-in module is intended for stepper motors with medium performance range. The PWM output stages cover a wide range of voltages and currents. Together with two inputs for limit switches, they are located in the EtherCAT plug-in module. The second input can also be configured as an output, thus enabling the use of a holding brake.

The EJ7047 can be adjusted to the motor and the application by changing just a few parameters. With its torsion-proof, integrated encoder (1,024 inc/rev), the AS2000 stepper motor is ideal for the closed-loop control of the EJ7047.

The LEDs indicate status, warning and error messages as well as possibly active limitations.

## 4.2 Technical data

Technical data	EJ7047
Technology	Compact Drive Technology
Number of outputs	1 stepper motor, 2 phases, 1 x motor brake (configurable, 0.5 A)
Number of digital inputs	2 end position, 4 for an encoder system
Number of channels	1 stepper motor, encoder input, 2 digital inputs (Input 2 configurable for motor brake)
Connection method	direct motor connection
Load type	uni- or bipolar stepper motors
Supply voltage electronics	24 V <sub>DC</sub> (via distribution board)
Supply voltage power	8 ... 48 V <sub>DC</sub> (via distribution board)
Output current max.	5 A (overload- and short-circuit-proof)
Maximum step frequency	1000, 2000, 4000, 8000 or 16000 full steps/s (configurable)
Step pattern	64-fold micro stepping
Current controller frequency	approx. 64 kHz
Diagnostics LED	error phase A and B, power, enable
Resolution	approx. 5,000 positions in typical applications (per revolution)
Electrical isolation	500 V (E-bus/signal voltage)
Current consumption load voltage (Up contacts)	typ. 70 mA (via distribution board)
Current consumption from the E-bus	typ. 140 mA
Distributed clocks (DC)	yes
Encoder input signal	5 V <sub>DC</sub> ... 24 V <sub>DC</sub> , 5 mA typ., single-ended
Encoder pulse frequency	maximum 400,000 increments/s (4-fold evaluation)
Support NoCoEStorage	yes
Permissible ambient temperature range during operation	0°C ... +55°C
Permissible ambient temperature range during storage	-25°C ... + 85°C
Permissible relative humidity	95 %, no condensation
Operation altitude	max. 2.000 m
Dimensions (W x H x D)	approx. 24 mm x 66 mm x 55 mm
Weight	approx. 50 g
Installation	on signal distribution board
Pollution degree	2
Installation position	Standard see <a href="#">note [► 31]</a> !
Position of coding pins <a href="#">[► 34]</a>	1 and 8
Color coding	orange
Vibration/shock resistance	conforms to EN 60068-2-6 / EN 60068-2-27 (with corresponding distribution board)
EMC immunity/emission	according to EN 61000-6-2 / EN 61000-6-4 (with corresponding distribution board) according to IEC/EN 61800-3 (with corresponding signal distribution board)
EMC category	category C3 - standard category C2, C1 - auxiliary filter required
Protection class	EJ module: IP20 EJ system: dependent on signal distribution board and housing
Approvals/markings*	CE, EAC, UKCA UL (see <a href="#">note [► 24]</a> )

\*) Real applicable approvals/markings see type plate on the side (product marking).

### **i** CE approval

The CE Marking refers to the EtherCAT plug-in module mentioned above. If the EtherCAT plug-in module is used in the production of a ready-to-use end product (PCB in conjunction with a housing), the manufacturer of the end product must check compliance of the overall system with relevant directives and CE certification. To operate the EtherCAT plug-in modules, they must be installed in a housing.

**UL notice - Compact Motion**

---

**● Notes on motion devices****• *Motor overtemperature***

Motor overtemperature sensing is not provided by the drive.

**• *Application for compact motion devices***

The modules are intended for use only within Beckhoff's Programmable Controller system Listed in File E172151.

**• *Galvanic isolation from the supply***

The modules are intended for operation within circuits not connected directly to the supply mains (galvanically isolated from the supply, i.e. on transformer secondary).

**• *Requirements for environmental conditions***

For use in Pollution Degree 2 Environment only.

---



### 4.3 Pinout

EJ7047 Left connector (Encoder)				EJ7047 Right connector (Motor)				E-Bus contacts  The power supply $U_{E\text{BUS}}$ is provided by the coupler and supplied from the supply voltage $U_S$ of the EtherCAT coupler.
Pin#		Signal		Pin#		Signal		
1	2	$U_{E\text{BUS}}$	$U_{E\text{BUS}}$	1	2	NC	NC	
3	4	GND	GND	3	4	GND	GND	
5	6	RX0+	TX1+	5	6	NC	NC	
7	8	RX0-	TX1-	7	8	NC	NC	
9	10	GND	GND	9	10	GND	GND	
11	12	TX0+	RX1+	11	12	NC	NC	
13	14	TX0-	RX1-	13	14	NC	NC	
15	16	GND	GND	15	16	GND	GND	
17	18	NC	Enc A	17	18	MotorA A1	MotorA A1	
19	20	NC	Enc B	19	20	MotorA A2	MotorA A2	
21	22	NC	Enc C	21	22	MotorB B1	MotorB B1	
23	24	NC	Latch	23	24	MotorB B2	MotorB B2	
25	26	NC	DI 1	25	26	48V_Motor	48V_Motor	
27	28	NC	DI 2	27	28	48V_Motor	48V_Motor	
29	30	GND Sensor	24V Sensor	29	30	GND_Motor	GND_Motor	
31	32	NC	NC	31	32	GND_Motor	GND_Motor	
33	34	0V Up	0V Up	33	34	0V Up	0V Up	
35	36	0V Up	24V Up	35	36	0V Up	24V Up	
37	38	24V Up	24V Up	37	38	24V Up	24V Up	
39	40	SGND	SGND	39	40	SGND	SGND	

The power supply  $U_{E\text{BUS}}$  is provided by the coupler and supplied from the supply voltage  $U_S$  of the EtherCAT coupler.

Signals and power supply of motor and sensor

U<sub>F</sub>-Contacts

The peripheral voltage  $U_F$  supplies the electronics on the field side.

Left connector (Encoder)		Right connector (Motor)	
Signal	Description	Signal	Description
$U_{E\text{BUS}}$	E-Bus power supply 3.3 V	NC	Do not connect
GND	E-Bus GND signal. Don't connect with 0V Up!	GND	E-Bus GND signal. Don't connect with 0V Up!
RXn+	Positive E-Bus receive signal		
RXn-	Negative E-Bus receive signal		
TXn+	Positive E-Bus transmit signal		
TXn-	Negative E-Bus transmit signal		
NC	Do not connect	MotorA A1	Motor winding A
Enc A	Encoder-Input A	MotorA A2	Motor winding A
Enc B	Encoder-Input B	MotorB B1	Motor winding B
Enc C	Encoder-Input C	MotorB B2	Motor winding B
Latch	Latch Input	48V_Motor	Feeding for output stage max. +48 V <sub>DC</sub>
DI 1 ... DI2	Digital Input 1 ... 2	GND_Motor	Feeding for output stage 0 V <sub>DC</sub>
GND Sensor	0 V Encoder Supply		
24V Sensor	24 V Encoder Supply		
0V Up	Field side GND signal	0V Up	Field side GND signal
24V Up	Field side power supply 24 V	24V Up	Field side power supply 24 V
SGND	Shield Ground	SGND	Shield Ground

Fig. 11: EJ7047 - Pinout

The PCB footprint can be downloaded from Beckhoff [homepage](#).

NOTICE	
	<p><b>Damage to devices possible!</b></p> <ul style="list-style-type: none"> <li>• The pins named with “NC” must not be connected.</li> <li>• Before installation and commissioning read the chapters <a href="#">Installation of EJ modules</a> [▶ 27] and <a href="#">Commissioning</a> [▶ 42]!</li> </ul>

**Shielding**

**i** Feedback signal, sensors and actuators should always be connected with shielded, twisted paired wires.

## 4.4 LEDs

LED No.	EJ7047	
	Left	Right
A	RUN	Driver
B	Encoder	Power
C		
1	ENC A	EN
2	ENC B	WARN
3	ENC C	ERR A
4	Latch	ERR B
5		
6		
7	I 1	CW
8	I 2	CCW
9		
10		
11		
12		
13		
14		
15		
16		

Fig. 12: EJ7047 - LEDs

LEDs (left side)				
LED	Color	Display	State	Meaning
RUN	green	off	Init	State of the EtherCAT State Machine: <b>INIT</b> = Initialization of the terminal or <b>BOOTSTRAP</b> = Function for firmware updates of the terminal
		blinking	Pre-Operational	State of the EtherCAT State Machine: <b>PREOP</b> = Setting for mailbox communication and variant standard settings
		single flash	Safe-Operational	State of the EtherCAT State Machine: <b>SAFEOP</b> = Channel checking of the <u>Sync-Manager</u> and the Distributed Clocks. Outputs stay in safe operation mode.
		on	Operational	State of the EtherCAT State Machine: <b>OP</b> = Normal operation mode, mailbox- and process data communication possible
		flickering	Bootstrap	State of the EtherCAT State Machine: <b>BOOTSTRAP</b> = function for <u>firmware updates</u> of the plug-in module
Encoder	green	on	-	Encoder ready for operation
ENC A	green	on	-	Signal at encoder input A
ENC B	green	on	-	Signal at encoder input B
ENC C	green	on	-	Signal at encoder input C
Latch	green	on	-	Signal at latch input
I 1	green	on	-	Signal at digital input 1
I 2	green	on	-	Signal at digital input 2

LEDs (right side)			
LED	Color	Display	Meaning
Driver	green	on	Driver stage ready for operation
Power	green	off	The power supply voltage (48 V <sub>DC</sub> ) is absent or the motor control is blocked (Index 0x6010:02 is not set)
		on	The power supply voltage (48 V <sub>DC</sub> ) is present
EN	green	off	The motor control is blocked (Index 0x6010:02 is not set) or EJ7047 is not ready for operation.
		on	The motor control is activated (Index 0x6010:02 is set) or EJ7047 is ready for operation.
WARN	yellow	off	No errors
		on	Configuration error, e.g.: <ul style="list-style-type: none"> <li>• Motor power supply not connected</li> <li>• 80°C temperature exceeded</li> <li>• 100% duty cycle reached</li> <li>•...</li> </ul>
ERR A ERR B	red	on	Configuration error of output stage A or B, e.g.: <ul style="list-style-type: none"> <li>• 100°C temperature exceeded</li> <li>• short circuit</li> <li>•...</li> </ul>
CW	green	on	Motor is triggered clockwise
CCW	green	on	Motor is triggered counter clockwise

## 5 Installation of EJ modules

### 5.1 Power supply for the EtherCAT plug-in modules

**⚠ WARNING**

**Power supply from SELV/PELV power supply unit!**

SELV/PELV circuits (Safety Extra Low Voltage, Protective Extra Low Voltage) according to IEC 61010-2-201 must be used to supply this device.

Notes:

- SELV/PELV circuits may give rise to further requirements from standards such as IEC 60204-1 et al, for example with regard to cable spacing and insulation.
- A SELV (Safety Extra Low Voltage) supply provides safe electrical isolation and limitation of the voltage without a connection to the protective conductor, a PELV (Protective Extra Low Voltage) supply also requires a safe connection to the protective conductor.

The signal distribution board should have a power supply designed for the maximum possible current load of the module string. Information on the current required from the E-bus supply can be found for each module in the respective documentation in section “Technical data”, online and in the catalog. The power requirement of the module string is displayed in the TwinCAT System Manager.

#### E-bus power supply with EJ1100 or EJ1101-0022 and EJ940x

The EJ1100 Bus Coupler supplies the connected EJ modules with the E-bus system voltage of 3.3 V. The Coupler can accommodate a load up to 2.2 A. If a higher current is required, a combination of the coupler EJ1101-0022 and the power supply units EJ9400 (2.5 A) or EJ9404 (12 A) should be used. The EJ940x power supply units can be used as additional supply modules in the module string.

Depending on the application, the following combinations for the E-bus supply are available:

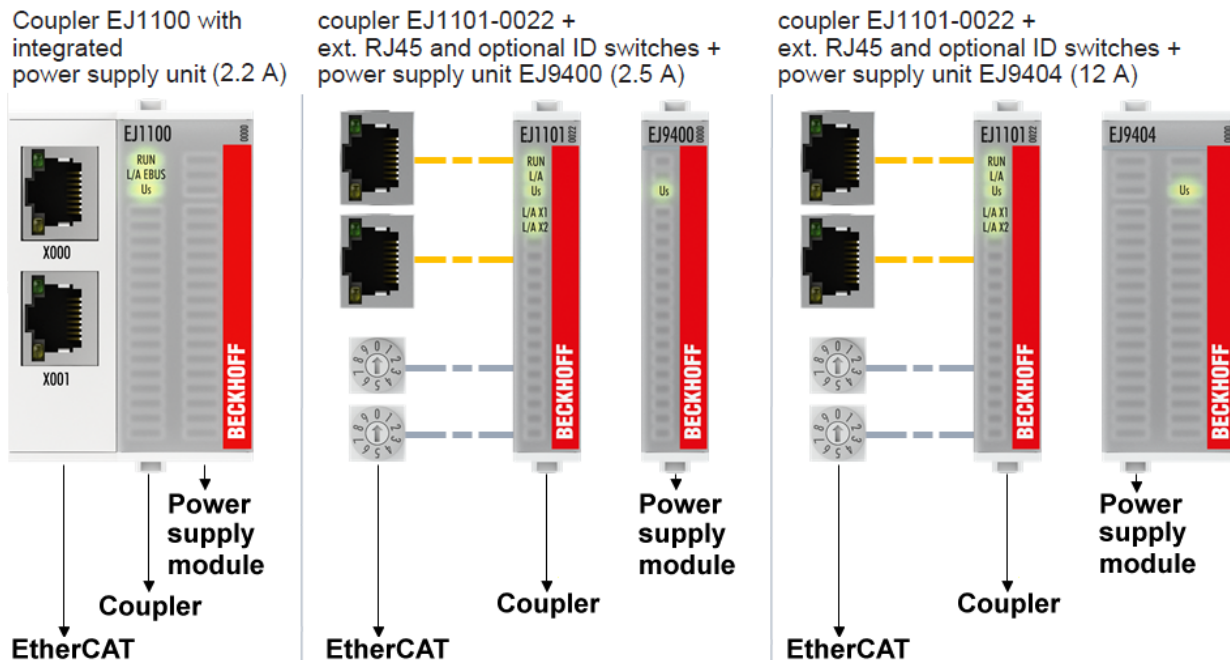

Fig. 13: E-bus power supply with EJ1100 or EJ1101-0022 + EJ940x

In the EJ1101-0022 coupler, the RJ45 connectors and optional ID switches are external and can be positioned anywhere on the signal distribution board, as required. This facilitates feeding through a housing.

The EJ940x power supply plug-in modules provide an optional reset function (see chapter Connection of the documentation for EJ9400 and EJ9404)

## E-bus power supply with CXxxxx and EK1110-004x

The Embedded PC supplies the attached EtherCAT Terminals and the EtherCAT EJ coupler

- with a supply voltage  $U_s$  of 24 V<sub>DC</sub> (-15 %/+20 %). This voltage supplies the E-bus and the bus terminal electronics.  
The CXxxxx units supply the E-bus with up to 2,000 mA E-bus current. If a higher current is required due to the attached terminals, power feed terminals or power supply plug-in modules must be used for the E-bus supply.
- with a peripheral voltage  $U_p$  of 24 V<sub>DC</sub> to supply the field electronics.

The EK1110-004x EtherCAT EJ couplers relay the following parameters to the signal distribution board via the rear connector:

- the E-bus signals,
- the E-bus voltage  $U_{EBUS}$  (3.3 V) and
- the peripheral voltage  $U_p$  (24 V<sub>DC</sub>).



Fig. 14: PCB with Embedded PC, EK1110-0043 and EJxxxx, rear view EK1110-0043

## 5.2 Note on load voltage supply

### ⚠ WARNING

#### Load voltage supply

Some devices permit an additional load voltage, e.g. 48 V DC, to be connected for the operation of a motor. In order to avoid stray currents on the protective conductor during operation, EN 60204-1:2018 provides for the possibility that the negative pole of the load voltage does not necessarily have to be connected to the protective conductor system (SELV).

Therefore, the load voltage supply should be designed as an SELV supply.

### 5.3 EJxxxx - dimensions

The EJ modules are compact and lightweight thanks to their design. Their volume is approx. 50 % smaller than the volume of the EL terminals. A distinction is made between four different module types, depending on the width and the height:

Module type	Dimensions (W x H x D)	Sample in figure below
Coupler	44 mm x 66 mm x 55 mm	EJ1100 (ej_44_2xjr45_coupler)
Single module	12 mm x 66 mm x 55 mm	EJ1809 (ej_12_16pin_code13)
Double module	24 mm x 66 mm x 55 mm	EJ7342 (ej_24_2x16pin_code18)
Single module (long)	12 mm x 152 mm x 55 mm	EJ1957 (ej_12_2x16pin_extended_code4747)

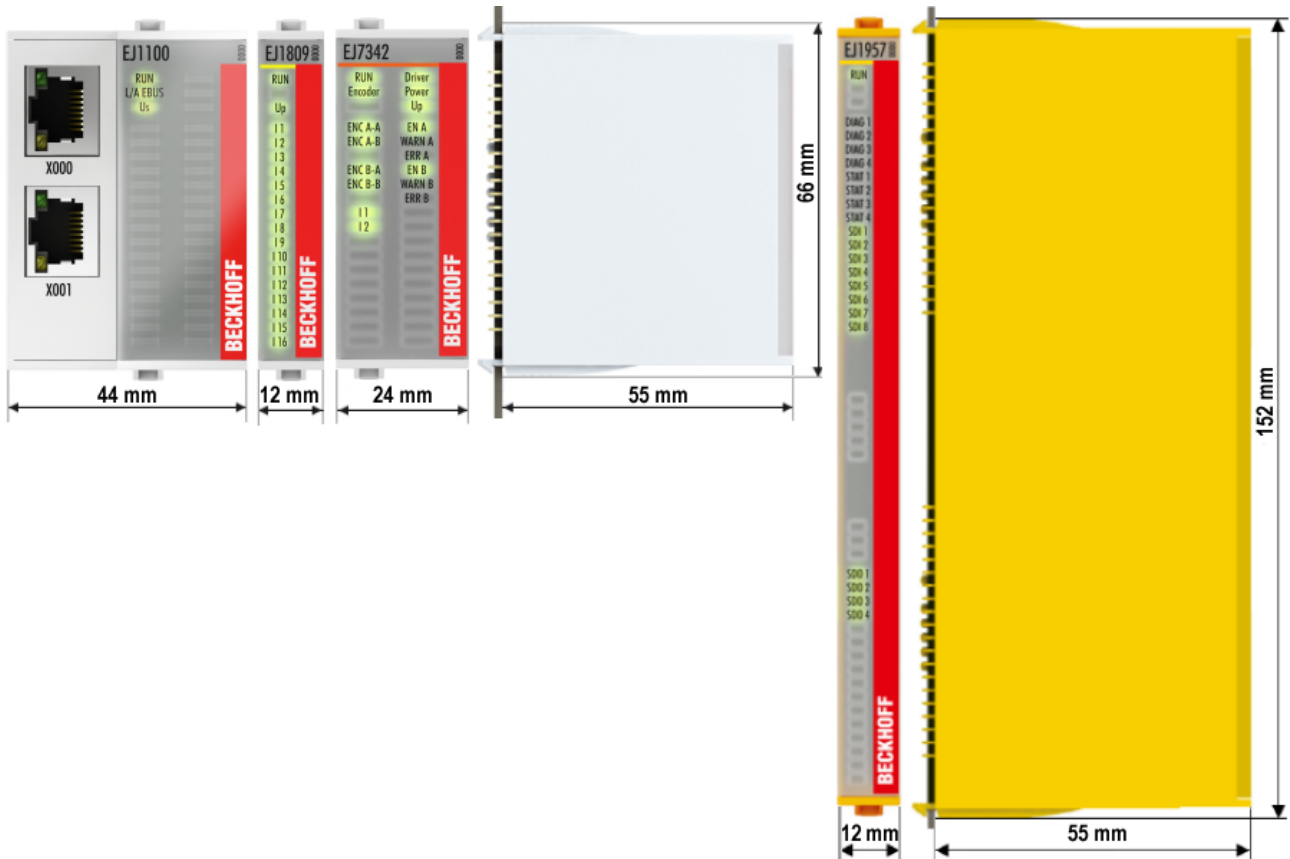

Fig. 15: EJxxxx - Dimensions

The technical drawings can be downloaded from the Beckhoff [homepage](#). The drawings are named as described in the drawing below.

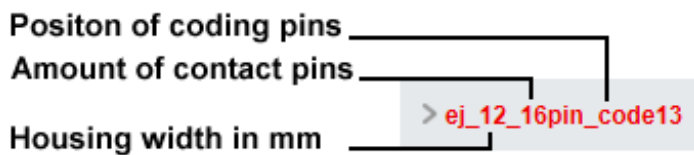

Fig. 16: Naming of the technical drawings

## 5.4 Installation positions and minimum distances

### 5.4.1 Minimum distances for ensuring installability

Note the dimensions shown in the following diagram for the design of the signal distribution board to ensure safe latching and simple assembly / disassembly of the modules.

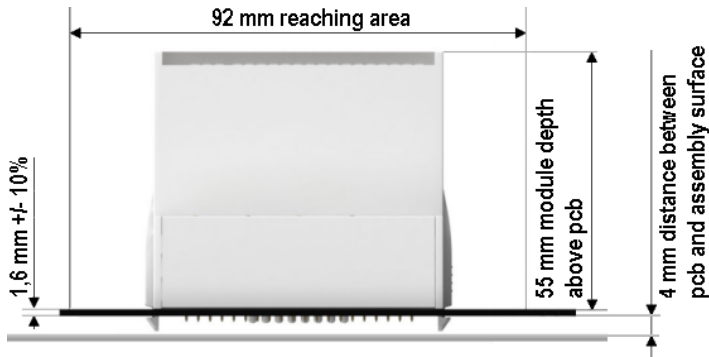

Fig. 17: Mounting distances EJ module - PCB

#### **i** Observing the reaching area

A minimum reaching area of 92 mm is required for assembly / disassembly, in order to be able to reach the mounting tabs with the fingers.

Adherence to the recommended minimum distances for ventilation (see [section Installation position \[▶ 31\]](#)) ensures an adequate reaching area.

The signal distribution board must have a thickness of 1.6 mm and a minimum distance of 4 mm from the mounting surface, in order to ensure latching of the modules on the board.



### 5.4.2 Installation positions

**NOTICE**

**Constraints regarding installation position and operating temperature range**

Please refer to the [technical data \[▶\\_23\]](#) for the installed components to ascertain whether any restrictions regarding the mounting position and/or the operating temperature range have been specified. During installation of modules with increased thermal dissipation, ensure adequate distance above and below the modules to other components in order to ensure adequate ventilation of the modules during operation!

The standard installation position is recommended. If a different installation position is used, check whether additional ventilation measures are required.

Ensure that the specified conditions (see Technical data) are adhered to!

**Optimum installation position (standard)**

For the optimum installation position the signal distribution board is installed horizontally, and the fronts of the EJ modules face forward (see Fig. *Recommended distances for standard installation position*). The modules are ventilated from below, which enables optimum cooling of the electronics through convection. “From below” is relative to the acceleration of gravity.

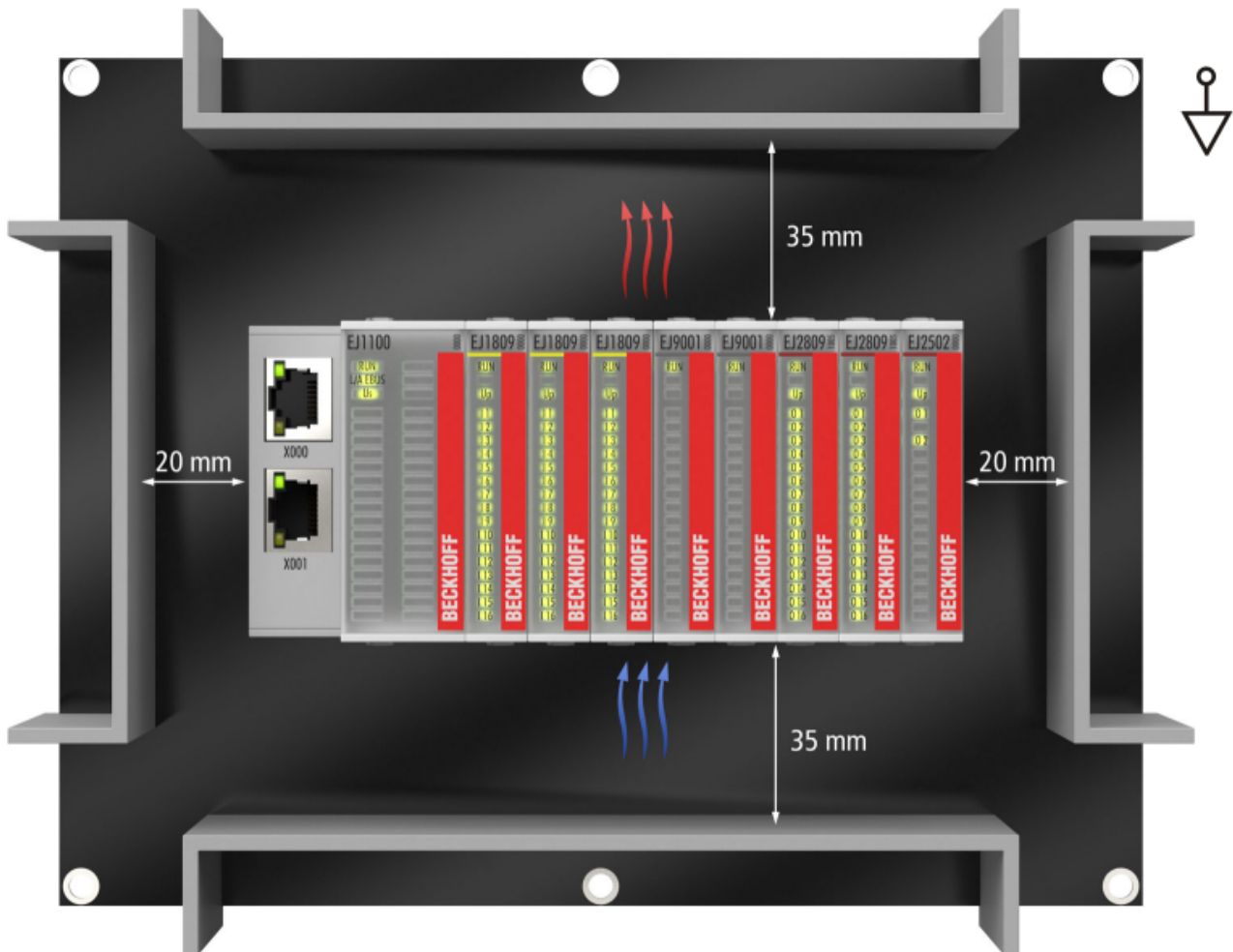

Fig. 18: Recommended distances for standard installation position

Compliance with the distances shown in Fig. *Recommended distances for standard installation position* is recommended. The recommended minimum distances should not be regarded as restricted areas for other components. The customer is responsible for verifying compliance with the environmental conditions described in the technical data. Additional cooling measures must be provided, if required.

**Other installation positions**

All other installation positions are characterized by a different spatial position of the signal distribution board, see Fig. *Other installation positions*.

The minimum distances to ambient specified above also apply to these installation positions.

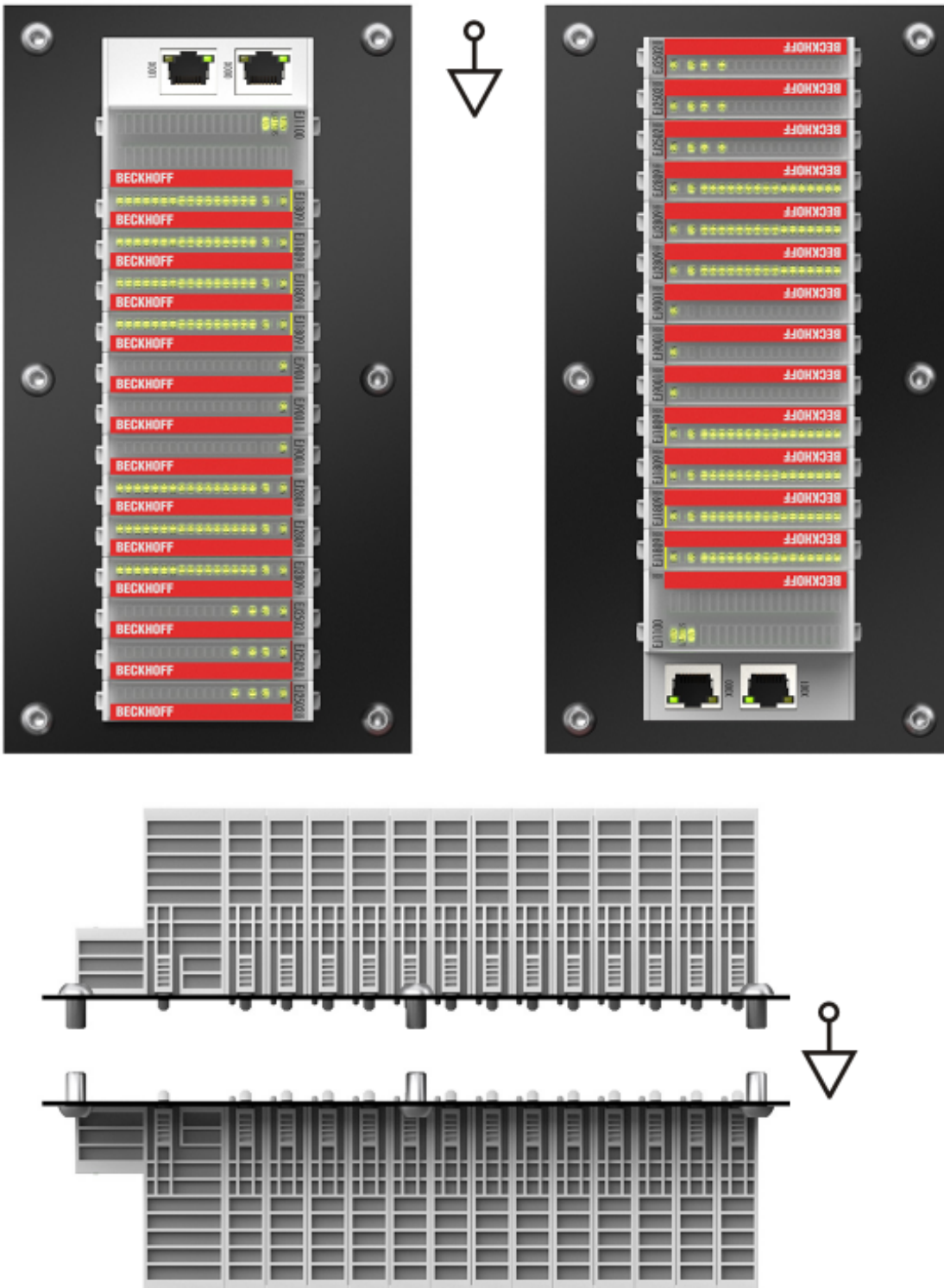

Fig. 19: Other installation positions



## 5.5 Codings

### 5.5.1 Color coding

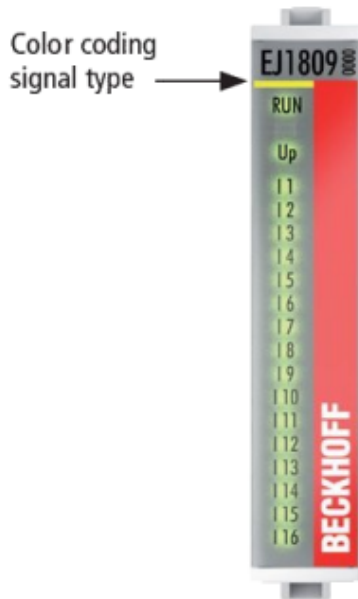

Fig. 20: EJ modules color code; sample: EJ1809

The EJ modules are color-coded for a better overview in the control cabinet (see diagram above). The color code indicates the signal type. The following table provides an overview of the signal types with corresponding color coding.

Signal type	Modules	Color
Coupler	EJ11xx	No color coding
Digital input	EJ1xxx	Yellow
Digital output	EJ2xxx	Red
Analog input	EJ3xxx	Green
Analog output	EJ4xxx	Blue
Position measurement	EJ5xxx	grey
Communication	EJ6xxx	grey
Motion	EJ7xxx	orange
System	EJ9xxx	grey

### 5.5.2 Mechanical position coding

The modules have two signal-specific coding pins on the underside (see Figs. B1 and B2 below). In conjunction with the coding holes in the signal distribution board (see Figs. A1 and A2 below), the coding pins provide an option for mechanical protection against incorrect connection. This significantly reduces the risk of error during installation and service.

Couplers and placeholder modules have no coding pins.

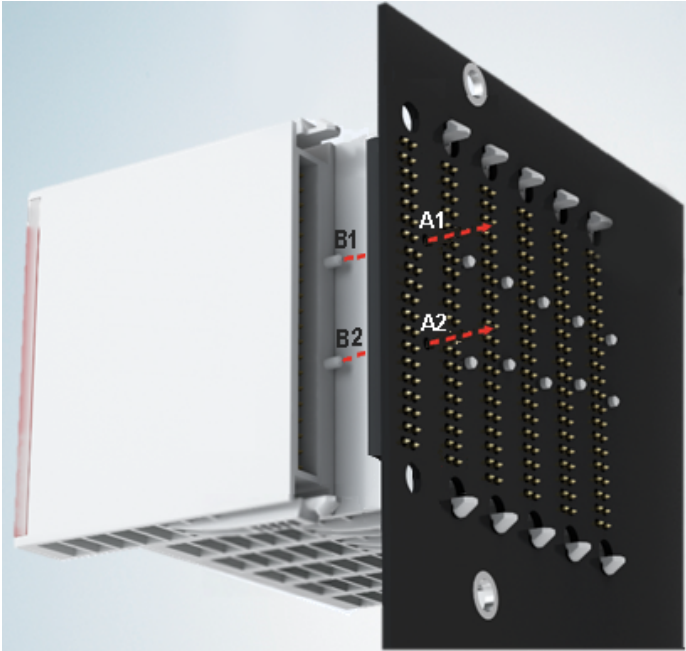

Fig. 21: Mechanical position coding with coding pins (B1 and B2) and coding holes (A1 and A2)

The following diagram shows the position of the position coding with position numbers on the left-hand side. Modules with the same signal type have the same coding. For sample, all digital input modules have the coding pins at positions one and three. There is no plug protection between modules with the same signal type. During installation the module type should therefore be verified based on the device name.

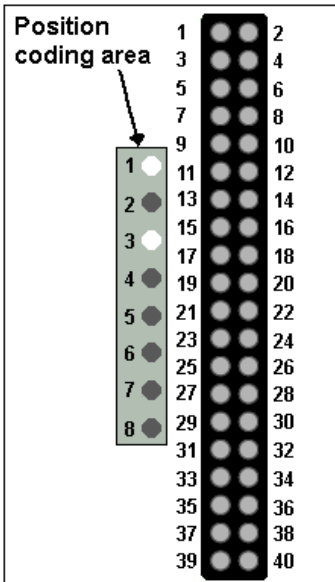

Fig. 22: Pin coding; sample: digital input modules

## 5.6 Installation on the signal distribution board

EJ modules are installed on the signal distribution board. The electrical connections between coupler and EJ modules are realized via the pin contacts and the signal distribution board.

The EJ components must be installed in a control cabinet or enclosure which must provide protection against fire hazards, environmental conditions and mechanical impact.

**⚠ WARNING**

**Risk of injury through electric shock and damage to the device!**

Bring the module system into a safe, de-energized state before starting installation, disassembly or wiring of the modules.

**NOTICE**

**Risk of damage to components through electrostatic discharge!**

Observe the regulations for ESD protection.

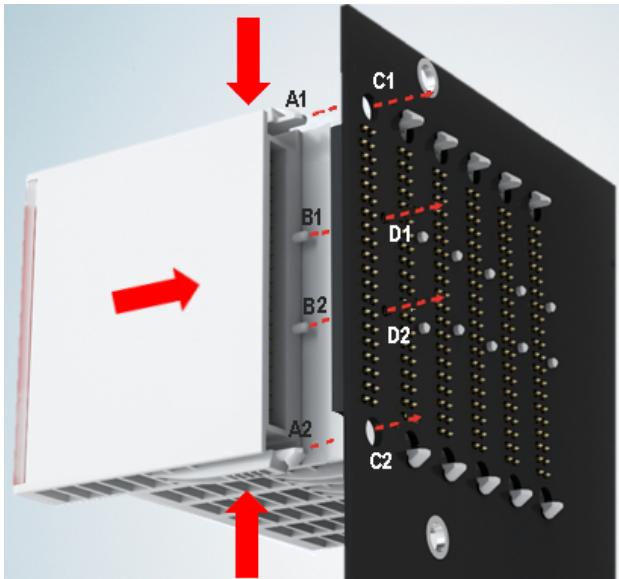

Fig. 23: Installation of EJ modules

A1 / A2	Latching lugs top / bottom	C1 / C2	Mounting holes
B1 / B2	Coding pins	D1 / D2	Coding holes

To install the modules on the signal distribution board proceed as follows:

1. Before the installation, ensure that the signal distribution board is securely connected to the mounting surface. Installation on an unsecured signal distribution board may result in damage to the board.
2. If necessary, check whether the positions of the coding pins (B) match the corresponding holes in the signal distribution board (D).
3. Compare the device name on the module with the information in the installation drawing.
4. Press the upper and the lower mounting tabs simultaneously and push the module onto the board while gently moving it up and down, until the module is latched securely.  
The required contact pressure can only be established and the maximum current carrying capacity ensured if the module is latched securely.
5. Use placeholder modules (EJ9001) to fill gaps in the module strand.

**NOTICE**

- During installation ensure safe latching of the modules on the signal distribution board! The consequences of inadequate contact pressure include:
  - ⇒ loss of quality of the transferred signals,
  - ⇒ increased power dissipation of the contacts,
  - ⇒ impairment of the service life.

## 5.7 Extension options

Three options are available for modifications and extensions of the EJ system.

- Replacing the placeholder modules with the function modules provided for the respective slot
- Assigning function modules specified for the respective slots for the reserve slots at the end of the module string
- Linking with EtherCAT Terminals and EtherCAT Box modules via an Ethernet/EtherCAT connection

### 5.7.1 Using placeholder modules for unused slots

The EJ9001 placeholder modules are used to close temporary gaps in the module strands (see Fig. A1 below). Gaps in the module strand cause interruption in EtherCAT communication and must be equipped with placeholder modules.

In contrast to the passive terminals of the EL series, the placeholder modules actively participate in the data exchange. Several placeholder modules can therefore be connected in series, without impairing the data exchange.

Unused slots at the end of the module strand can be left as reserve slots (see Fig. B1 below).

The machine complexity is extended (extended version) by allocating unused slots (see Figs. A2 below - Exchanging placeholder modules and B2 - Assigning reserve slots) according to the specifications for the signal distribution board.

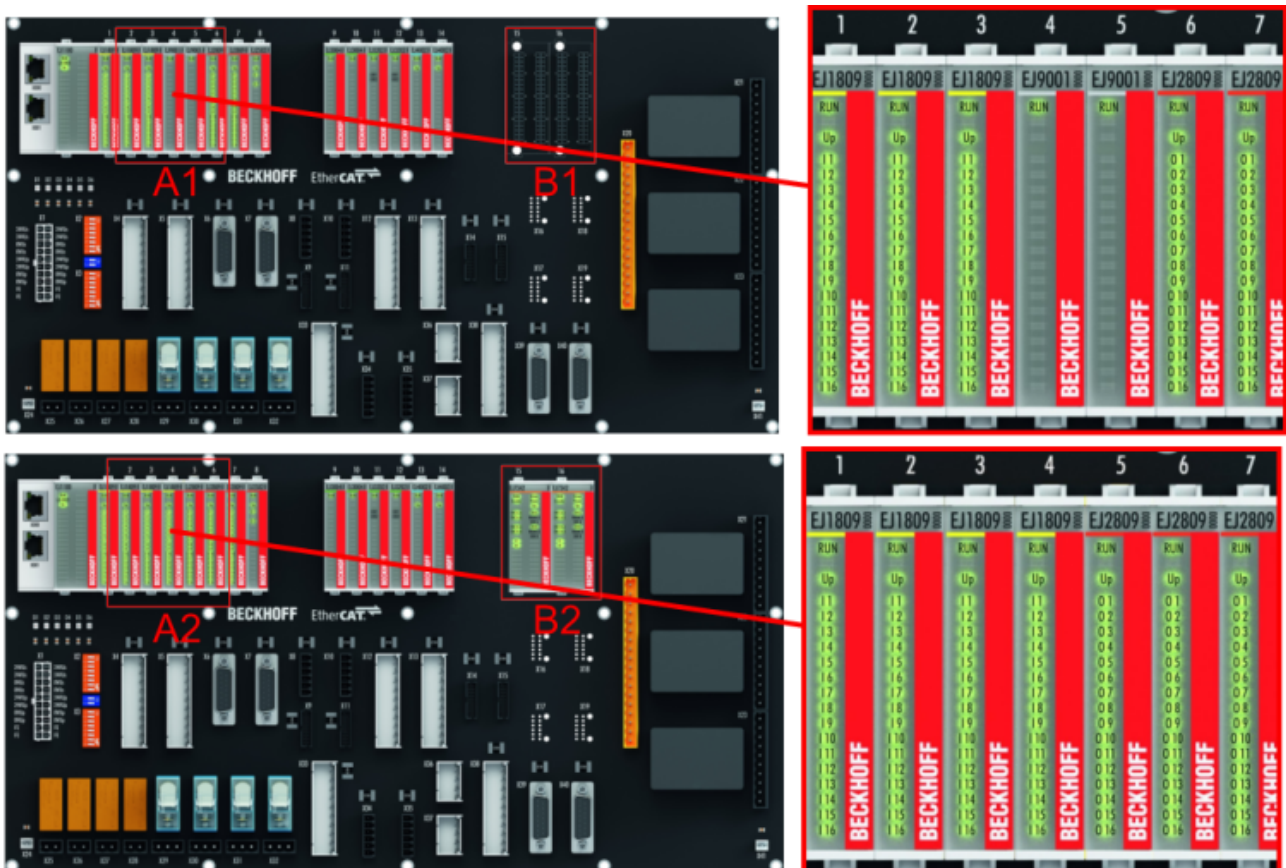

Fig. 24: Sample: Exchanging placeholder modules and assigning reserve slots

#### ● E-bus supply

**i** Exchange the placeholder modules with other modules changes the current input from the E-Bus. Ensure that adequate power supply is provided.

### 5.7.2 Linking with EtherCAT Terminals and EtherCAT Box modules via an Ethernet/EtherCAT connection

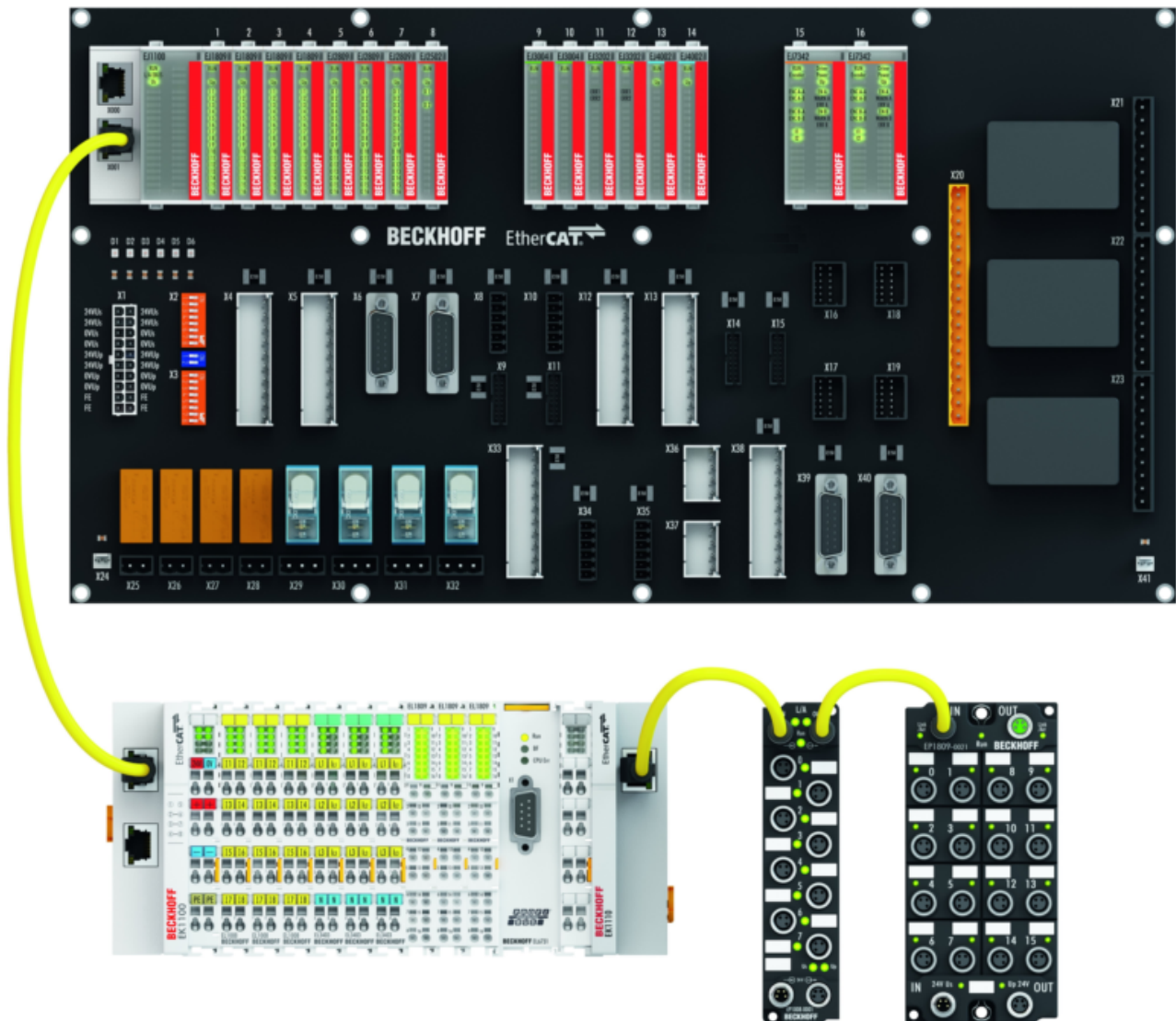

Fig. 25: Example of extension via an Ethernet/EtherCAT connection



## 5.8 IPC integration

### Connection of CX and EL terminals via the EK1110-004x EtherCAT EJ coupler

The EK1110-0043 and EK1110-0044 EtherCAT EJ couplers connect the compact DIN-rail PCs of the CX series and attached EtherCAT Terminals (ELxxx) with the EJ modules on the signal distribution board.

The EK1110-004x are supplied from the power supply unit of the Embedded PC.

The E-bus signals and the supply voltage of the field side  $U_p$  are routed directly to the PCB via a plug connector at the rear of the EtherCAT EJ couplers.

Due to the direct coupling of the Embedded PC and the EL terminals with the EJ modules on the PCB, no EtherCAT Extension (EK1110) or EtherCAT Coupler (EJ1100) is required.

The Embedded PC can be expanded with EtherCAT Terminals that are not yet available in the EJ system, for example.



Fig. 26: Example PCB with Embedded PC, EK1110-0043 and EJxxx, rear view EK1110-0043

**Connection of C6015 / C6017 via the EJ110x-00xx EtherCAT Coupler**

Thanks to their ultra-compact design and versatile mounting options, the C6015 and C6017 IPCs are ideally suited for connection to an EJ system.

In combination with the ZS5000-0003 mounting set, it is possible to place the C6015 and C6017 IPCs compactly on the signal distribution board.

The EJ system is optimally connected to the IPC via the corresponding EtherCAT Cable (see following Fig. [A]).

The IPC can be supplied directly via the signal distribution board using the enclosed power plug (see Fig. [B] below).

**NOTICE**



**Positioning on the signal distribution board**

The dimensions and distances for placement and other details can be found in the Design Guide and the documentation for the individual components.

The figure below shows the connection of a C6015 IPC to an EJ system as an example. The components shown are schematic, to illustrate the functionality.



Fig. 27: Example for the connection of a C6015 IPC to an EJ system

## 5.9 Disassembly of the signal distribution board

### ⚠ WARNING

#### Risk of injury through electric shock and damage to the device!

Bring the module system into a safe, de-energized state before starting installation, disassembly or wiring of the modules.

Each module is secured through latching on the distribution board, which has to be released for disassembly.

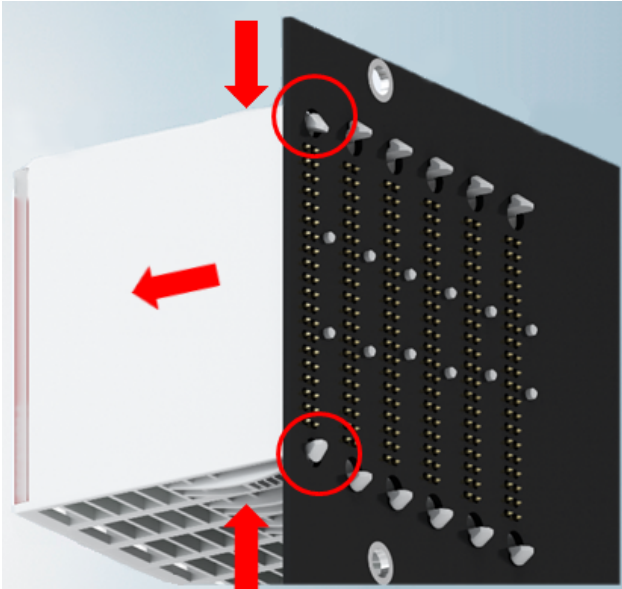

Fig. 28: Disassembly of EJ modules

To disassemble the module from the signal distribution board proceed as follows:

1. Before disassembly, ensure that the signal distribution board is securely connected to the mounting surface. Disassembly of an unsecured signal distribution board may result in damage to the board.
2. Press the upper and lower mounting tabs simultaneously and pull the module from board while gently moving it up and down.

## 5.10 Disposal



Products marked with a crossed-out wheeled bin shall not be discarded with the normal waste stream. The device is considered as waste electrical and electronic equipment. The national regulations for the disposal of waste electrical and electronic equipment must be observed.



## 6 EtherCAT basics

Please refer to the [EtherCAT System Documentation](#) for the EtherCAT fieldbus basics.

## 7 EJ7037 - Commissioning

### 7.1 Note on EL70x7 documentation

A detailed documentation for the commissioning of the EJ70x7 modules is in preparation.

#### NOTICE



#### Damage to devices or loss of data

The descriptions and instructions for commissioning the EL70x7 EtherCAT Terminals can be transferred to the EJ70x7 EtherCAT plug-in modules.

Before commissioning, read the detailed description of the process data, operation modes and parameterization in the [EL70x7](#) documentation.

### 7.2 EJ7037 - Object description and parameterization

#### ● EtherCAT XML Device Description



The display matches that of the CoE objects from the EtherCAT [XML](#) Device Description. We recommend downloading the latest XML file from the download area of the Beckhoff website and installing it according to installation instructions.

#### NOTICE



#### Parameterization via the CoE list (CAN over EtherCAT)

The EtherCAT device is parameterized via the CoE - Online tab (with a double click on the respective object) or via the Process Data tab (assignment of PDOs). A detailed description can be found in the EtherCAT System-Documentation in chapter "[EtherCAT subscriber configuration](#)"

Please note the general CoE notes in the EtherCAT System Documentation in chapter "[CoE-interface](#)" when using/manipulating the CoE parameters:

- Keep a startup list if components have to be replaced
- Differentiation between online/offline dictionary,
- existence of current XML description
- use "CoE reload" for resetting changes

#### NOTICE

#### Risk of damage to the device!

We strongly advise not to change settings in the CoE objects while the axis is active, since this could impair the control.

#### Introduction

The CoE overview contains objects for different intended applications:

- Objects required for parameterization during commissioning:
  - [Restore object](#) [[▶ 43](#)] object index 0x1011
  - [Configuration data](#) [[▶ 43](#)] index 0x80nn
  - [Vendor configuration data \(device-specific\)](#) [[▶ 47](#)] index 0xF80F
- Profile-specific objects:
  - [Input data](#) [[▶ 48](#)] index 0x60n0
  - [Output data](#) [[▶ 49](#)] index 0x70nn
  - [Information and diagnostic data](#) [[▶ 52](#)] Index 0x9010 .. 0xFB40
  - [Command object](#) [[▶ 47](#)] Index 0xFB00

- [Standard objects \(0x1000-0x1FFF\) \[► 54\]](#)

The following section first describes the objects required for normal operation, followed by a complete overview of missing objects.

## 7.2.1 Restore object

### Index 1011 Restore default parameters

Index (hex)	Name	Meaning	Data type	Flags	Default
1011:0	Restore default parameters	Restore default parameters	UINT8	RO	0x01 (1 <sub>dec</sub> )
1011:01	SubIndex 001	If this object is set to “ <b>0x64616F6C</b> ” in the set value dialog, all backup objects are reset to their delivery state.	UINT32	RW	0x00000000 (0 <sub>dec</sub> )

## 7.2.2 Configuration data

### Index 8000 ENC Settings Ch.1

Index (hex)	Name	Meaning	Data type	Flags	Default
8000:0	ENC Settings Ch.1	Length of this object	UINT8	RO	0x0E (14 <sub>dec</sub> )
8000:08	Disable filter	Deactivates the input filters	BOOLEAN	RW	0x00 (0 <sub>dec</sub> )
8000:0A	Enable micro increments	The lower 8 bits of the counter value are extrapolated.	BOOLEAN	RW	0x00 (0 <sub>dec</sub> )
8000:0E	Reversion of rotation	Activates reversion of rotation of the encoder	BOOLEAN	RW	0x00 (0 <sub>dec</sub> )

### Index 8010 STM Motor Settings Ch.1

Index (hex)	Name	Meaning	Data type	Flags	Default
8010:0	STM Motor Settings Ch.1	Length of this object	UINT8	RO	0x11 (17 <sub>dec</sub> )
8010:01	Maximal current	Maximum permanent motor coil current <b>Unit:</b> 1 mA	UINT16	RW	0x05DC (1500 <sub>dec</sub> )
8010:02	Reduced current	reduced coil current <b>Unit:</b> 1 mA.	UINT16	RW	0x01F4 (2500 <sub>dec</sub> )
8010:03	Nominal voltage	Nominal voltage (supply voltage) of the motor <b>Unit:</b> 10 mV	UINT16	RW	0x0960 (2400 <sub>dec</sub> )
8010:04	Motor coil resistance	Internal resistance of the motor <b>Unit:</b> 10 mOhm	UINT16	RW	0x0064 (100 <sub>dec</sub> )
8010:05	Motor EMF	Countervoltage of the motor <b>Unit:</b> 1 mV / (rad/s)	UINT16	RW	0x0000 (0 <sub>dec</sub> )
8010:06	Motor fullsteps	Number of full motor steps	UINT16	RW	0x00C8 (200 <sub>dec</sub> )
8010:07	Encoder increments (4fold)	Number of encoder increments per revolution with 4-fold evaluation	UINT16	RW	0x1000 (4096 <sub>dec</sub> )
8010:09	Start velocity	Minimum starting velocity of the motor <b>Unit:</b> 10000 corresponds to 100%	UINT16	RW	0x0000 (0 <sub>dec</sub> )
8010:0A	Motor coil inductance	Inductance of the motor <b>Unit:</b> 0.01 mH	UINT16	RW	0x0000 (0 <sub>dec</sub> )
8010:10	Drive on delay time	Delay between activation of the driver stage and Ready = 1 <b>Unit:</b> 1 ms	UINT16	RW	0x0064 (100 <sub>dec</sub> )
8010:11	Drive off delay time	Delay between Ready = 0 and deactivation of the driver stage <b>Unit:</b> 1 ms	UINT16	RW	0x0096 (150 <sub>dec</sub> )

**Index 8011 STM Controller Settings Ch.1**

Index (hex)	Name	Meaning	Data type	Flags	Default
8011:0	STM Controller Settings Ch.1	Length of this object	UINT8	RO	0x02 (2 <sub>dec</sub> )
8011:01	Kp factor (curr.)	Kp control factor of the current controller	UINT16	RW	0x0096 (150 <sub>dec</sub> )
8011:02	Ki factor (curr.)	Ki control factor of the current controller	UINT16	RW	0x000A (10 <sub>dec</sub> )

**Index 8012 STM Features Ch.1**

Index (hex)	Name	Meaning	Data type	Flags	Default
8012:0	STM Features Ch.1	Length of this object	UINT8	RO	0x3A (58 <sub>dec</sub> )
8012:01	Operation mode	Permitted values: 0: Automatic 1: Velocity direct 3: Position controller 4: Ext. Velocity mode 5: Ext. Position mode 6: Velocity sensorless	BIT4	RW	0x00 (0 <sub>dec</sub> )
8012:05	Speed range	Permitted values: 0: 1000 full steps / s 1: 2000 full steps / s 2: 4000 full steps / s 3: 8000 full steps / s 4: 16000 full steps / s 5: 32000 full steps / s	BIT3	RW	0x01 (1 <sub>dec</sub> )
8012:08	Feedback type	Permitted values: 0: Encoder 1: Internal counter	BIT1	RW	0x01 (1 <sub>dec</sub> )
8012:09	Invert motor polarity	Invert the direction of rotation of the motor	BOOLEAN	RW	0x00 (0 <sub>dec</sub> )
8012:0A	Error on step lost	Error on loss of step	BOOLEAN	RW	0x00 (0 <sub>dec</sub> )
8012:0B	Fan cartridge present	Fan cartridge present	BOOLEAN	RW	0x00 (0 <sub>dec</sub> )
8012:11	Select info data 1	Permitted values: 0: Status word 7: Motor velocity 11: Motor load 13: Motor dc current 101: Internal temperature 103: Control voltage 104: Motor supply voltage 150: Drive - Status word 151: Drive - State 152: Drive - Position lag (low word) 153: Drive - Position lag (high word)	UINT8	RW	0x0B (11 <sub>dec</sub> )
8012:19	Select info data 2	Permitted values: 0: Status word 7: Motor velocity 11: Motor load 13: Motor dc current 101: Internal temperature 103: Control voltage 104: Motor supply voltage 150: Drive - Status word 151: Drive - State 152: Drive - Position lag (low word) 153: Drive - Position lag (high word)	UINT8	RW	0x0D (13 <sub>dec</sub> )
8012:30	Invert digital input 1	Invert digital input	BOOLEAN	RW	0x00 (0 <sub>dec</sub> )
8012:31	Invert digital input 2	Invert digital input	BOOLEAN	RW	0x00 (0 <sub>dec</sub> )
8012:32	Function for input 1	Permitted values: 0: Normal input 1: Hardware enable 2: PLC cam 3: Auto start	BIT4	RW	0x00 (0 <sub>dec</sub> )
8012:36	Function for input 2	Permitted values: 0: Normal input 1: Hardware enable 2: PLC cam 3: Auto start	BIT4	RW	0x00 (0 <sub>dec</sub> )
8012:3A	Function for output 1	Permitted values: 0: Normal output 1: Break (linked with driver enable) 15: Disabled	BIT4	RW	0x0F (15 <sub>dec</sub> )

## Index 8014 STM Controller Settings 3 Ch.1

Index (hex)	Name	Meaning	Data type	Flags	Default
8014:0	STM Controller Settings 3 Ch.1	Length of this object	UINT8	RO	0x09 (9 <sub>dec</sub> )
8014:01	Feed forward (pos.)	Pilot control of the position controller	UINT32	RW	0x000186A0 (10000 <sub>dec</sub> )
8014:02	Kp factor (pos.)	Kp control factor of the position controller	UINT16	RW	0x01F4 (500 <sub>dec</sub> )
8014:03	Kp factor (velo.)	Kp control factor of the velocity controller <b>Unit:</b> 0.01 ms	UINT32	RW	0x00000032 (50 <sub>dec</sub> )
8014:04	Tn (velo.)	Time constant Tn of the velocity controller <b>Unit:</b> 0.1 mA/(rad/s)	UINT16	RW	0xC350 (50000 <sub>dec</sub> )
8014:05	Sensorless param 1	First parameter (sensorless control)	UINT16	RW	0x0000 (0 <sub>dec</sub> )
8014:06	Sensorless param 2	Second parameter (sensorless control)	UINT16	RW	0x0000 (0 <sub>dec</sub> )
8014:07	Cross over velocity 1	First velocity transition (sensorless control) <b>Unit:</b> 0.1 rad/s	UINT16	RW	0x0000 (0 <sub>dec</sub> )
8014:08	Cross over velocity 2	Second velocity transition (sensorless control) <b>Unit:</b> 0.1 rad/s	UINT16	RW	0x0000 (0 <sub>dec</sub> )
8014:09	Cross over velocity 3	Third velocity transition (sensorless control) <b>Unit:</b> 0.1 rad/s	UINT16	RW	0x0000 (0 <sub>dec</sub> )

## Index 8020 POS Settings Ch.1

Index (hex)	Name	Meaning	Data type	Flags	Default
8020:0	POS Settings Ch.1	Length of this object	UINT8	RO	0x11 (17 <sub>dec</sub> )
8020:01	Velocity min.	Minimum set velocity (range: 0-10000)	INT16	RW	0x0064 (100 <sub>dec</sub> )
8020:02	Velocity max.	Maximum set velocity (range: 0-10000)	INT16	RW	0x2710 (10000 <sub>dec</sub> )
8020:03	Acceleration pos.	Acceleration time in positive direction of rotation <b>Unit:</b> 1 ms	UINT16	RW	0x03E8 (1000 <sub>dec</sub> )
8020:04	Acceleration neg.	Acceleration time in negative direction of rotation <b>Unit:</b> 1 ms	UINT16	RW	0x03E8 (1000 <sub>dec</sub> )
8020:05	Deceleration pos.	Deceleration time in positive direction of rotation <b>Unit:</b> 1 ms	UINT16	RW	0x03E8 (1000 <sub>dec</sub> )
8020:06	Deceleration neg.	Deceleration time in negative direction of rotation <b>Unit:</b> 1 ms	UINT16	RW	0x03E8 (1000 <sub>dec</sub> )
8020:07	Emergency deceleration	Emergency deceleration time (both directions of rotation) <b>Unit:</b> 1 ms	UINT16	RW	0x0064 (100 <sub>dec</sub> )
8020:08	Calibration position	Calibration position	UINT32	RW	0x00000000 (0 <sub>dec</sub> )
8020:09	Calibration velocity (towards plc cam)	Calibration velocity towards the cam (range: 0-10000)	INT16	RW	0x0064 (100 <sub>dec</sub> )
8020:0A	Calibration velocity (off plc cam)	Calibration velocity away from the cam (range: 0-10000)	INT16	RW	0x000A (10 <sub>dec</sub> )
8020:0B	Target window	Target window	UINT16	RW	0x000A (10 <sub>dec</sub> )
8020:0C	In-Target timeout	Target position timeout <b>Unit:</b> 1 ms	UINT16	RW	0x03E8 (1000 <sub>dec</sub> )
8020:0D	Dead time compensation	Dead time compensation <b>Unit:</b> 1 µs	INT16	RW	0x0032 (50 <sub>dec</sub> )
8020:0E	Modulo factor	Modulo factor/position	UINT32	RW	0x00000000 (0 <sub>dec</sub> )
8020:0F	Modulo tolerance window	Tolerance window for modulo positioning	UINT32	RW	0x00000000 (0 <sub>dec</sub> )
8020:10	Position lag max.	Maximum allowable step error	UINT16	RW	0x0000 (0 <sub>dec</sub> )
8020:11	Calibration acceleration (around plc cam)	Acceleration and braking ramps for homing runs	UINT16	RW	0x0000 (0 <sub>dec</sub> )

**Index 8021 POS Features Ch.1**

Index (hex)	Name	Meaning	Data type	Flags	Default
8021:0	POS Features Ch.1	Length of this object	UINT8	RO	0x16 (22 <sub>dec</sub> )
8021:01	Start type	permitted values: 0: Idle 1: Absolute 2: Relative 3: Endless plus 4: Endless minus 6: Additive 24832: Calibration (Hardware sync) 2457: Calibration (Plc cam) 28416: Calibration (Clear manual) 28160: Calibration (Set manual) 28161: Calibration (Set manual auto) 1029: Modulo current 773: Modulo minus 517: Modulo plus 261: Modulo short	UINT16	RW	0x0001 (1 <sub>dec</sub> )
8021:11	Time information	permitted values: 0: Elapsed time current drive time since start of the motion command	BIT2	RW	0x00 (0 <sub>dec</sub> )
8021:13	Invert calibration cam search direction	Inversion of the direction of rotation towards the cam	BOOLEAN	RW	0x01 (1 <sub>dec</sub> )
8021:14	Invert sync impulse search direction	Inversion of the direction of rotation away from the cam	BOOLEAN	RW	0x00 (0 <sub>dec</sub> )
8021:15	Emergency stop on position lag error	Triggers an emergency stop if the maximum following error is exceeded	BOOLEAN	RW	0x00 (0 <sub>dec</sub> )
8021:16	Enhanced diag history	Provides detailed messages about the status of the positioning interface in the diag history	BOOLEAN	RW	0x00 (0 <sub>dec</sub> )

**7.2.3 Vendor configuration data (device-specific)**

**Index F80F STM Vendor data**

Index (hex)	Name	Meaning	Data type	Flags	Default
F80F:0	STM Vendor data	General information for the modular device profile	UINT8	RO	0x05 (5 <sub>dec</sub> )
F80F:04	Warning temperature	Temperature warning threshold Unit: 1°C	INT8	RW	0x50 (80 <sub>dec</sub> )
F80F:05	Switch off temperature	Switch-off temperature Unit: 1°C	INT8	RW	0x64 (100 <sub>dec</sub> )

**7.2.4 Command object**

**Index FB00 STM Command**

Index (hex)	Name	Meaning	Data type	Flags	Default
FB00:0	STM Command	General information for the modular device profile	UINT8	RO	0x03 (3 <sub>dec</sub> )
FB00:01	Request	Requesting a command 0x8000: Software reset	OCTET-STRING[2]	RW	{0}
FB00:02	Status	Status of the command: 0: no error, without return value 1: no error, with return value 2: with error, no return value 3: with error, with return value .... reserved 255: Command execution active	UINT8	RO	0x00 (0 <sub>dec</sub> )
FB00:03	Response	Return value of the executed command	OCTET STRING[4]	RO	{0}

## 7.2.5 Input data

### Index 6000 ENC Inputs Ch.1

Index (hex)	Name	Meaning	Data type	Flags	Default
6000:0	ENC Inputs Ch.1	Length of this object	UINT8	RO	0x16 (22 <sub>dec</sub> )
6000:01	Latch C valid	The counter value was interlocked with the C-track.	BOOLEAN	RO	0x00 (0 <sub>dec</sub> )
6000:02	Latch extern valid	The counter value was stored via the external latch.	BOOLEAN	RO	0x00 (0 <sub>dec</sub> )
6000:03	Set counter done	The counter was set.	BOOLEAN	RO	0x00 (0 <sub>dec</sub> )
6000:04	Counter underflow	Counter underflow.	BOOLEAN	RO	0x00 (0 <sub>dec</sub> )
6000:05	Counter overflow	Counter overflow.	BOOLEAN	RO	0x00 (0 <sub>dec</sub> )
6000:08	Extrapolation stall	The extrapolated part of the counter is invalid	BOOLEAN	RO	0x00 (0 <sub>dec</sub> )
6000:09	Status of input A	Status of the A-input	BOOLEAN	RO	0x00 (0 <sub>dec</sub> )
6000:0A	Status of input B	Status of the B-input	BOOLEAN	RO	0x00 (0 <sub>dec</sub> )
6000:0B	Status of input C	Status of the C-input	BOOLEAN	RO	0x00 (0 <sub>dec</sub> )
6000:0D	Status of extern latch	The status of the external latch input	BOOLEAN	RO	0x00 (0 <sub>dec</sub> )
6000:0E	Sync error	The Sync error bit is only required for DC mode. It indicates whether a synchronization error has occurred during the previous cycle.	BOOLEAN	RO	0x00 (0 <sub>dec</sub> )
6000:10	TxPDO Toggle	The TxPDO toggle is toggled by the slave when the data of the associated TxPDO is updated.	BOOLEAN	RO	0x00 (0 <sub>dec</sub> )
6000:11	Counter value	The counter value	UINT32	RO	0x00000000 (0 <sub>dec</sub> )
6000:12	Latch value	The latch value	UINT32	RO	0x00000000 (0 <sub>dec</sub> )
6000:16	Timestamp	Timestamp of the last counter change	UINT32	RO	0x00000000 (0 <sub>dec</sub> )

### Index 6010 STM Inputs Ch. 1

Index (hex)	Name	Meaning	Data type	Flags	Default
6010:0	STM Inputs Ch. 1	Length of this object	UINT8	RO	0x15 (21 <sub>dec</sub> )
6010:01	Ready to enable	Driver stage is ready for enabling	BOOLEAN	RO	0x00 (0 <sub>dec</sub> )
6010:02	Ready	Driver stage is ready for operation	BOOLEAN	RO	0x00 (0 <sub>dec</sub> )
6010:03	Warning	a warning has occurred (see Index 0xA010 [► 53]) was activated.	BOOLEAN	RO	0x00 (0 <sub>dec</sub> )
6010:04	Error	an error has occurred (see Index 0xA010 [► 53]) was activated.	BOOLEAN	RO	0x00 (0 <sub>dec</sub> )
6010:05	Moving positive	Driver stage is activated in positive direction	BOOLEAN	RO	0x00 (0 <sub>dec</sub> )
6010:06	Moving negative	Driver stage is activated in negative direction	BOOLEAN	RO	0x00 (0 <sub>dec</sub> )
6010:07	Torque reduced	Reduced torque is active	BOOLEAN	RO	0x00 (0 <sub>dec</sub> )
6010:08	Motor stall	A loss of step has occurred	BOOLEAN	RO	0x00 (0 <sub>dec</sub> )
6010:0C	Digital input 1	Digital input 1	BOOLEAN	RO	0x00 (0 <sub>dec</sub> )
6010:0D	Digital input 2	Digital input 2	BOOLEAN	RO	0x00 (0 <sub>dec</sub> )
6010:0E	Sync error	The Sync error bit is only required for DC mode. It indicates whether a synchronization error has occurred during the previous cycle.	BOOLEAN	RO	0x00 (0 <sub>dec</sub> )
6010:10	TxPDO Toggle	The TxPDO toggle is toggled by the slave when the data of the associated TxPDO is updated	BOOLEAN	RO	0x00 (0 <sub>dec</sub> )
6010:11	Info data 1	Synchronous information (selection via subindex 0x8012:11 [► 45])	UINT16	RO	0x0000 (0 <sub>dec</sub> )
6010:12	Info data 2	Synchronous information (selection via subindex 0x8012:19 [► 45])	UINT16	RO	0x0000 (0 <sub>dec</sub> )
6010:13	Motor load	Current motor load <b>Unit:</b> 0.01°	INT16	RO	0x0000 (0 <sub>dec</sub> )
6010:14	Internal position	Internal microstep position	UINT32	RO	0x00000000 (0 <sub>dec</sub> )
6010:15	External position	Encoder position	UINT32	RO	0x00000000 (0 <sub>dec</sub> )



**Index 6020 POS Inputs Ch. 1**

Index (hex)	Name	Meaning	Data type	Flags	Default
6020:0	POS Inputs Ch. 1	Length of this object	UINT8	RO	0x23 (35 <sub>dec</sub> )
6020:01	Busy	A current motion command is active	BOOLEAN	RO	0x00 (0 <sub>dec</sub> )
6020:02	In-Target	Motor has arrived at target	BOOLEAN	RO	0x00 (0 <sub>dec</sub> )
6020:03	Warning	A warning has occurred	BOOLEAN	RO	0x00 (0 <sub>dec</sub> )
6020:04	Error	An error has occurred	BOOLEAN	RO	0x00 (0 <sub>dec</sub> )
6020:05	Calibrated	Motor is calibrated	BOOLEAN	RO	0x00 (0 <sub>dec</sub> )
6020:06	Accelerate	Motor is in the acceleration phase	BOOLEAN	RO	0x00 (0 <sub>dec</sub> )
6020:07	Decelerate	Motor is in the deceleration phase	BOOLEAN	RO	0x00 (0 <sub>dec</sub> )
6020:08	Ready to execute	ready for motion command	BOOLEAN	RO	0x00 (0 <sub>dec</sub> )
6020:11	Actual position	Current set position of the motion command generator	UINT32	RO	0x00000000 (0 <sub>dec</sub> )
6020:21	Actual velocity	Current set velocity of the motion command generator	INT16	RO	0x0000 (0 <sub>dec</sub> )
6020:22	Actual drive time	Motion command time information (see subindex 0x8021:11 [▶ 47])	UINT32	RO	0x00000000 (0 <sub>dec</sub> )
6020:23	Actual position lag	Following error	INT32	RO	0x00000000 (0 <sub>dec</sub> )

**7.2.6 Output data**

**Index 7000 ENC Outputs Ch. 1**

Index (hex)	Name	Meaning	Data type	Flags	Default
7000:0	ENC Outputs Ch. 1	Maximum subindex	UINT8	RO	0x11 (17 <sub>dec</sub> )
7000:01	Enable latch C	Activate saving via input "C".	BOOLEAN	RO	0x00 (0 <sub>dec</sub> )
7000:02	Enable latch extern on positive edge	Activate external latch with positive edge.	BOOLEAN	RO	0x00 (0 <sub>dec</sub> )
7000:03	Set counter	Set counter value	BOOLEAN	RO	0x00 (0 <sub>dec</sub> )
7000:04	Enable latch extern on negative edge	Activate external latch with negative edge.	BOOLEAN	RO	0x00 (0 <sub>dec</sub> )
7000:11	Set counter value	The counter value to be set via "Set counter" (Index 0x7000:03).	UINT32	RO	0x00000000 (0 <sub>dec</sub> )

**Index 7010 STM Outputs Ch. 1**

Index (hex)	Name	Meaning	Data type	Flags	Default
7010:0	STM Outputs Ch. 1	Maximum subindex	UINT8	RO	0x21 (33 <sub>dec</sub> )
7010:01	Enable	activates the output stage	BOOLEAN	RO	0x00 (0 <sub>dec</sub> )
7010:02	Reset	all errors that may have occurred are reset by setting this bit (rising edge)	BOOLEAN	RO	0x00 (0 <sub>dec</sub> )
7010:03	Reduce torque	Reduced torque (coil current) is active (see Subindex 0x8010:02 [▶ 43])	BOOLEAN	RO	0x00 (0 <sub>dec</sub> )
7010:0C	Digital output 1	Digital output 1	BOOLEAN	RO	0x00 (0 <sub>dec</sub> )
7010:11	Position	Set position specification <b>Unit:</b> Increments	UINT32	RO	0x00000000 (0 <sub>dec</sub> )
7010:21	Velocity	Set velocity specification <b>Unit:</b> ±32767 corresponds to ±100%	INT16	RO	0x0000 (0 <sub>dec</sub> )

## Index 7020 POS Outputs Ch. 1

Index (hex)	Name	Meaning	Data type	Flags	Default																																												
7020:0	POS Outputs Ch. 1	Maximum subindex	UINT8	RO	0x24 (36 <sub>dec</sub> )																																												
7020:01	Execute	Start motion command (rising edge), or prematurely abort motion command (falling edge)	BOOLEAN	RO	0x00 (0 <sub>dec</sub> )																																												
7020:02	Emergency Stop	Prematurely abort motion command with an emergency ramp (rising edge)	BOOLEAN	RO	0x00 (0 <sub>dec</sub> )																																												
7020:11	Target position	Specification of the target position	UINT32	RO	0x00000000 (0 <sub>dec</sub> )																																												
7020:21	Velocity	Specification of the maximum step velocity	INT16	RO	0x0000 (0 <sub>dec</sub> )																																												
7020:22	Start type	<table border="1"> <tbody> <tr> <td>0x0000 Idle</td> <td>No motion command is being executed</td> </tr> <tr> <td>0x0001 Absolute</td> <td>Absolute target position</td> </tr> <tr> <td>0x1001 Absolute (change)</td> <td>Change during an active motion command</td> </tr> <tr> <td>0x0002 Relative</td> <td>Target position relative to the current position</td> </tr> <tr> <td>0x1002 Relative (change)</td> <td>Change during an active motion command</td> </tr> <tr> <td>0x0003 Endless plus</td> <td>Endless driving in positive direction of rotation</td> </tr> <tr> <td>0x0004 Endless minus</td> <td>Endless driving in negative direction of rotation</td> </tr> <tr> <td>0x0105 Modulo short</td> <td>Shortest distance to the next modulo position</td> </tr> <tr> <td>0x0115 Modulo short extended</td> <td>Shortest distance to the next modulo position (without modulo window)</td> </tr> <tr> <td>0x0205 Modulo plus</td> <td>Drive in positive direction of rotation to the next modulo position</td> </tr> <tr> <td>0x0215 Modulo plus extended</td> <td>Drive in positive direction of rotation to the next modulo position (without modulo window)</td> </tr> <tr> <td>0x0305 Modulo minus</td> <td>Drive in negative direction of rotation to the next modulo position</td> </tr> <tr> <td>0x0315 Modulo minus extended</td> <td>Drive in negative direction of rotation to the next modulo position (without modulo window)</td> </tr> <tr> <td>0x0405 Modulo current</td> <td>Drive in the last implemented direction of rotation to the next modulo position</td> </tr> <tr> <td>0x0415 Modulo current extended</td> <td>Drive in the last implemented direction of rotation to the next modulo position (without modulo window)</td> </tr> <tr> <td>0x0006 Additive</td> <td>New target position relative/additive to the last target position</td> </tr> <tr> <td>0x1006 Additive (change)</td> <td>Change during an active motion command</td> </tr> <tr> <td>0x6000 Calibration, PLC cam</td> <td>Calibration with cam</td> </tr> <tr> <td>0x6100 Calibration, HW sync</td> <td>Calibration with cam and C-track</td> </tr> <tr> <td>0x6E00 Calibration, set manual</td> <td>Set calibration manually</td> </tr> <tr> <td>0x6E01 Calibration, set manual auto</td> <td>Set calibration automatically, with "Enable=1"</td> </tr> <tr> <td>0x6F00 Calibration, clear manual</td> <td>Clear calibration manually</td> </tr> </tbody> </table>	0x0000 Idle	No motion command is being executed	0x0001 Absolute	Absolute target position	0x1001 Absolute (change)	Change during an active motion command	0x0002 Relative	Target position relative to the current position	0x1002 Relative (change)	Change during an active motion command	0x0003 Endless plus	Endless driving in positive direction of rotation	0x0004 Endless minus	Endless driving in negative direction of rotation	0x0105 Modulo short	Shortest distance to the next modulo position	0x0115 Modulo short extended	Shortest distance to the next modulo position (without modulo window)	0x0205 Modulo plus	Drive in positive direction of rotation to the next modulo position	0x0215 Modulo plus extended	Drive in positive direction of rotation to the next modulo position (without modulo window)	0x0305 Modulo minus	Drive in negative direction of rotation to the next modulo position	0x0315 Modulo minus extended	Drive in negative direction of rotation to the next modulo position (without modulo window)	0x0405 Modulo current	Drive in the last implemented direction of rotation to the next modulo position	0x0415 Modulo current extended	Drive in the last implemented direction of rotation to the next modulo position (without modulo window)	0x0006 Additive	New target position relative/additive to the last target position	0x1006 Additive (change)	Change during an active motion command	0x6000 Calibration, PLC cam	Calibration with cam	0x6100 Calibration, HW sync	Calibration with cam and C-track	0x6E00 Calibration, set manual	Set calibration manually	0x6E01 Calibration, set manual auto	Set calibration automatically, with "Enable=1"	0x6F00 Calibration, clear manual	Clear calibration manually	UINT16	RO	0x0000 (0 <sub>dec</sub> )
0x0000 Idle	No motion command is being executed																																																
0x0001 Absolute	Absolute target position																																																
0x1001 Absolute (change)	Change during an active motion command																																																
0x0002 Relative	Target position relative to the current position																																																
0x1002 Relative (change)	Change during an active motion command																																																
0x0003 Endless plus	Endless driving in positive direction of rotation																																																
0x0004 Endless minus	Endless driving in negative direction of rotation																																																
0x0105 Modulo short	Shortest distance to the next modulo position																																																
0x0115 Modulo short extended	Shortest distance to the next modulo position (without modulo window)																																																
0x0205 Modulo plus	Drive in positive direction of rotation to the next modulo position																																																
0x0215 Modulo plus extended	Drive in positive direction of rotation to the next modulo position (without modulo window)																																																
0x0305 Modulo minus	Drive in negative direction of rotation to the next modulo position																																																
0x0315 Modulo minus extended	Drive in negative direction of rotation to the next modulo position (without modulo window)																																																
0x0405 Modulo current	Drive in the last implemented direction of rotation to the next modulo position																																																
0x0415 Modulo current extended	Drive in the last implemented direction of rotation to the next modulo position (without modulo window)																																																
0x0006 Additive	New target position relative/additive to the last target position																																																
0x1006 Additive (change)	Change during an active motion command																																																
0x6000 Calibration, PLC cam	Calibration with cam																																																
0x6100 Calibration, HW sync	Calibration with cam and C-track																																																
0x6E00 Calibration, set manual	Set calibration manually																																																
0x6E01 Calibration, set manual auto	Set calibration automatically, with "Enable=1"																																																
0x6F00 Calibration, clear manual	Clear calibration manually																																																
7020:23	Acceleration	Acceleration specification	UINT16	RO	0x0000 (0 <sub>dec</sub> )																																												
7020:24	Deceleration	Deceleration specification	UINT16	RO	0x0000 (0 <sub>dec</sub> )																																												

**Index 7021 POS Outputs 2 Ch. 1**

Index (hex)	Name	Meaning	Data type	Flags	Default																																												
7021:0	POS Outputs 2 Ch. 1	Maximum subindex	UINT8	RO	0x24 (36 <sub>dec</sub> )																																												
7021:03	Enable auto start	Enable auto-start function	BOOLEAN	RO	0x00 (0 <sub>dec</sub> )																																												
7021:11	Target position	Specification of the target position	UINT32	RO	0x00000000 (0 <sub>dec</sub> )																																												
7021:21	Velocity	Specification of the maximum set velocity	INT16	RO	0x0000 (0 <sub>dec</sub> )																																												
7021:22	Start type	<table border="1"> <tr> <td>0x0000 Idle</td> <td>No motion command is being executed</td> </tr> <tr> <td>0x0001 Absolute</td> <td>Absolute target position</td> </tr> <tr> <td>0x1001 Absolute (change)</td> <td>Change during an active motion command</td> </tr> <tr> <td>0x0002 Relative</td> <td>Target position relative to the current position</td> </tr> <tr> <td>0x1002 Relative (change)</td> <td>Change during an active motion command</td> </tr> <tr> <td>0x0003 Endless plus</td> <td>Endless driving in positive direction of rotation</td> </tr> <tr> <td>0x0004 Endless minus</td> <td>Endless driving in negative direction of rotation</td> </tr> <tr> <td>0x0105 Modulo short</td> <td>Shortest distance to the next modulo position</td> </tr> <tr> <td>0x0115 Modulo short extended</td> <td>Shortest distance to the next modulo position (without modulo window)</td> </tr> <tr> <td>0x0205 Modulo plus</td> <td>Drive in positive direction of rotation to the next modulo position</td> </tr> <tr> <td>0x0215 Modulo plus extended</td> <td>Drive in positive direction of rotation to the next modulo position (without modulo window)</td> </tr> <tr> <td>0x0305 Modulo minus</td> <td>Drive in negative direction of rotation to the next modulo position</td> </tr> <tr> <td>0x0315 Modulo minus extended</td> <td>Drive in negative direction of rotation to the next modulo position (without modulo window)</td> </tr> <tr> <td>0x0405 Modulo current</td> <td>Drive in the last implemented direction of rotation to the next modulo position</td> </tr> <tr> <td>0x0415 Modulo current extended</td> <td>Drive in the last implemented direction of rotation to the next modulo position (without modulo window)</td> </tr> <tr> <td>0x0006 Additive</td> <td>New target position relative/additive to the last target position</td> </tr> <tr> <td>0x1006 Additive (change)</td> <td>Change during an active motion command</td> </tr> <tr> <td>0x6000 Calibration, PLC cam</td> <td>Calibration with cam</td> </tr> <tr> <td>0x6100 Calibration, HW sync</td> <td>Calibration with cam and C-track</td> </tr> <tr> <td>0x6E00 Calibration, set manual</td> <td>Set calibration manually</td> </tr> <tr> <td>0x6E01 Calibration, set manual auto</td> <td>Set calibration automatically, with "Enable=1"</td> </tr> <tr> <td>0x6F00 Calibration, clear manual</td> <td>Clear calibration manually</td> </tr> </table>	0x0000 Idle	No motion command is being executed	0x0001 Absolute	Absolute target position	0x1001 Absolute (change)	Change during an active motion command	0x0002 Relative	Target position relative to the current position	0x1002 Relative (change)	Change during an active motion command	0x0003 Endless plus	Endless driving in positive direction of rotation	0x0004 Endless minus	Endless driving in negative direction of rotation	0x0105 Modulo short	Shortest distance to the next modulo position	0x0115 Modulo short extended	Shortest distance to the next modulo position (without modulo window)	0x0205 Modulo plus	Drive in positive direction of rotation to the next modulo position	0x0215 Modulo plus extended	Drive in positive direction of rotation to the next modulo position (without modulo window)	0x0305 Modulo minus	Drive in negative direction of rotation to the next modulo position	0x0315 Modulo minus extended	Drive in negative direction of rotation to the next modulo position (without modulo window)	0x0405 Modulo current	Drive in the last implemented direction of rotation to the next modulo position	0x0415 Modulo current extended	Drive in the last implemented direction of rotation to the next modulo position (without modulo window)	0x0006 Additive	New target position relative/additive to the last target position	0x1006 Additive (change)	Change during an active motion command	0x6000 Calibration, PLC cam	Calibration with cam	0x6100 Calibration, HW sync	Calibration with cam and C-track	0x6E00 Calibration, set manual	Set calibration manually	0x6E01 Calibration, set manual auto	Set calibration automatically, with "Enable=1"	0x6F00 Calibration, clear manual	Clear calibration manually	UINT16	RO	0x0000 (0 <sub>dec</sub> )
0x0000 Idle	No motion command is being executed																																																
0x0001 Absolute	Absolute target position																																																
0x1001 Absolute (change)	Change during an active motion command																																																
0x0002 Relative	Target position relative to the current position																																																
0x1002 Relative (change)	Change during an active motion command																																																
0x0003 Endless plus	Endless driving in positive direction of rotation																																																
0x0004 Endless minus	Endless driving in negative direction of rotation																																																
0x0105 Modulo short	Shortest distance to the next modulo position																																																
0x0115 Modulo short extended	Shortest distance to the next modulo position (without modulo window)																																																
0x0205 Modulo plus	Drive in positive direction of rotation to the next modulo position																																																
0x0215 Modulo plus extended	Drive in positive direction of rotation to the next modulo position (without modulo window)																																																
0x0305 Modulo minus	Drive in negative direction of rotation to the next modulo position																																																
0x0315 Modulo minus extended	Drive in negative direction of rotation to the next modulo position (without modulo window)																																																
0x0405 Modulo current	Drive in the last implemented direction of rotation to the next modulo position																																																
0x0415 Modulo current extended	Drive in the last implemented direction of rotation to the next modulo position (without modulo window)																																																
0x0006 Additive	New target position relative/additive to the last target position																																																
0x1006 Additive (change)	Change during an active motion command																																																
0x6000 Calibration, PLC cam	Calibration with cam																																																
0x6100 Calibration, HW sync	Calibration with cam and C-track																																																
0x6E00 Calibration, set manual	Set calibration manually																																																
0x6E01 Calibration, set manual auto	Set calibration automatically, with "Enable=1"																																																
0x6F00 Calibration, clear manual	Clear calibration manually																																																
7021:23	Acceleration	Acceleration specification	UINT16	RO	0x0000 (0 <sub>dec</sub> )																																												
7021:24	Deceleration	Deceleration specification	UINT16	RO	0x0000 (0 <sub>dec</sub> )																																												

## 7.2.7 Information and diagnostic data

### Channel-specific:

#### Index 9010 STM Info data Ch.1

Index (hex)	Name	Meaning	Data type	Flags	Default
9010:0	STM Info data Ch.1	General information for the modular device profile	UINT8	RO	0x13 (19 <sub>dec</sub> )
9010:01	Status word	Status word (see index 0xA010 [► 53])	UINT16	RO	0x0000 (0 <sub>dec</sub> )
9010:08	Motor velocity	Current motor velocity	INT16	RO	0x0000 (0 <sub>dec</sub> )
9010:09	Internal position	Internal position (micro increments)	UINT32	RO	0x00000000 (0 <sub>dec</sub> )
9010:0B	Motor load	Current motor load <b>Unit:</b> 0.01°	INT16	RO	0x0000 (0 <sub>dec</sub> )
9010:0D	Motor dc current	Current motor current (DC vector) <b>Unit:</b> 1 mA	INT16	RO	0x0000 (0 <sub>dec</sub> )
9010:0E	Tn (curr.)	Internally calculated time constant of the current controller <b>Unit:</b> 0.01 ms	UINT16	RO	0x0000 (0 <sub>dec</sub> )
9010:13	External position	external position (connected encoder)	UINT32	RO	0x00000000 (0 <sub>dec</sub> )

#### Index 9020 POS Info data Ch.1

Index (hex)	Name	Meaning	Data type	Flags	Default
9020:0	POS Info data Ch.1	General information for the modular device profile	UINT8	RO	0x04 (4 <sub>dec</sub> )
9020:01	Status word	Status word	UINT16	RO	0x0000 (0 <sub>dec</sub> )
9020:03	State (drive controller)	permitted values: 0: Init 1: Idle 16: Start 17: Acceleration 18: Constant 19: Deceleration 20: Deceleration on change 32: Emergency stop 33: Normal stop 256: Calibration start 257: Go cam acceleration 258: On cam deceleration 272: Go cam 273: On cam 274: Back to cam 288: Go sync impulse 289: Leave cam 304: Calibration stop 320: Is calibrated 321: Not calibrated 4096: Pre target 4097: In target 8192: Drive end 8192: Wait for init 16384: Drive warning 32768: Error 65535: Undefined	UINT16	RO	0x0000 (0 <sub>dec</sub> )
9020:04	Actual position lag	Current step error	INT32	RO	0x00000000 (0 <sub>dec</sub> )

**Index A010 STM Diag data Ch.1**

Index (hex)	Name	Meaning	Data type	Flags	Default
A010:0	STM Diag data Ch.1	General information for the modular device profile	UINT8	RO	0x11 (17 <sub>dec</sub> )
A010:01	Saturated	Driver stage operates with maximum duty cycle	BOOLEAN	RO	0x00 (0 <sub>dec</sub> )
A010:02	Over temperature	Internal temperature of the module is higher than 80°C	BOOLEAN	RO	0x00 (0 <sub>dec</sub> )
A010:03	Torque overload	Duty cycle output at 100%	BOOLEAN	RO	0x00 (0 <sub>dec</sub> )
A010:04	Under voltage	Supply voltage is lower than 7 V	BOOLEAN	RO	0x00 (0 <sub>dec</sub> )
A010:05	Over voltage	Supply voltage is 10% higher than the rated voltage (see Index 0x8010:03 ▶ 43)	BOOLEAN	RO	0x00 (0 <sub>dec</sub> )
A010:06	Short circuit	Short circuit of motor coil	BOOLEAN	RO	0x00 (0 <sub>dec</sub> )
A010:08	No control power	No power supply to driver stage	BOOLEAN	RO	0x00 (0 <sub>dec</sub> )
A010:09	Misc error	<ul style="list-style-type: none"> <li>Initialization failed or</li> <li>Internal temperature of the module is higher than 100°C (see Index 0xF80F:05)</li> </ul>	BOOLEAN	RO	0x00 (0 <sub>dec</sub> )
A010:0A	Configuration	CoE change has not yet been adopted into the current configuration	BOOLEAN	RO	0x00 (0 <sub>dec</sub> )
A010:0B	Motor stall	A loss of step has occurred	BOOLEAN	RO	0x00 (0 <sub>dec</sub> )
A010:0C	Open load A		BOOLEAN	RO	0x00 (0 <sub>dec</sub> )
A010:0D	Open load B		BOOLEAN	RO	0x00 (0 <sub>dec</sub> )
A010:11	Actual operation mode	permitted values: 0: Automatic 1: Velocity direct 2: Velocity controller 3: Position controller 4: Ext. Velocity mode 5: Ext. Position mode 6: Velocity sensorless	BOOLEAN	RO	0x00 (0 <sub>dec</sub> )

**Index A020 POS Diag data Ch.1**

Index (hex)	Name	Meaning	Data type	Flags	Default
A020:0	POS Diag data Ch.1	General information for the modular device profile	UINT8	RO	0x06 (6 <sub>dec</sub> )
A020:01	Command rejected	Motion command was rejected	BOOLEAN	RO	0x00 (0 <sub>dec</sub> )
A020:02	Command aborted	Motion command was aborted	BOOLEAN	RO	0x00 (0 <sub>dec</sub> )
A020:03	Target overrun	Target window was overshoot in the opposite direction.	BOOLEAN	RO	0x00 (0 <sub>dec</sub> )
A020:04	Target timeout	The target window was not reached within the In-Target timeout.	BOOLEAN	RO	0x00 (0 <sub>dec</sub> )
A020:05	Position lag	The maximum following error was exceeded.	BOOLEAN	RO	0x00 (0 <sub>dec</sub> )
A020:06	Emergency Stop	An emergency stop was triggered (automatic or manual)	BOOLEAN	RO	0x00 (0 <sub>dec</sub> )

**Device-specific:**

**Index F000 Modular device profile**

Index (hex)	Name	Meaning	Data type	Flags	Default
F000:0	Modular device profile	General information for the modular device profile	UINT8	RO	0x02 (2 <sub>dec</sub> )
F000:01	Module index distance	Index distance of the objects of the individual channels	UINT16	RO	0x0010 (16 <sub>dec</sub> )
F000:02	Maximum number of modules	Number of channels	UINT16	RO	0x0003 (3 <sub>dec</sub> )

**Index F008 Code word**

Index (hex)	Name	Meaning	Data type	Flags	Default
F008:0	Code word	reserved	UINT32	RW	0x00000000 (0 <sub>dec</sub> )

**Index F010 Module list**

Index (hex)	Name	Meaning	Data type	Flags	Default
F010:0	Module list	Length of this object	UINT8	RW	0x03 (3 <sub>dec</sub> )
F010:01	SubIndex 001	-	UINT32	RW	0x000001FF (511 <sub>dec</sub> )
F010:02	SubIndex 002	-	UINT32	RW	0x000002BF (703 <sub>dec</sub> )
F010:03	SubIndex 003	-	UINT32	RW	0x000002C0 (704 <sub>dec</sub> )

**Index F081 Download revision**

Index (hex)	Name	Meaning	Data type	Flags	Default
F081:0	Download revision	General information for the modular device profile	UINT8	RO	0x01 (1 <sub>dec</sub> )
F081:01	Revision number	Revision number	UINT32	RW	0x00000000 (0 <sub>dec</sub> )

**Index F900 STM Info data**

Index (hex)	Name	Meaning	Data type	Flags	Default
F900:0	STM Info data	General information for the modular device profile	UINT8	RO	0x06 (6 <sub>dec</sub> )
F900:01	Software version (driver)	Software version of the output driver	STRING	RO	
F900:02	Internal temperature	Internal module temperature <b>Unit:</b> 1°C	INT8	RO	0x00 (0 <sub>dec</sub> )
F900:04	Control voltage	Control voltage <b>Unit:</b> 1 mV, 10 mV with field-oriented control	UINT16	RO	0x0000 (0 <sub>dec</sub> )
F900:05	Motor supply voltage	Motor supply voltage <b>Unit:</b> 1 mV, 10 mV with field-oriented control	UINT16	RO	0x0000 (0 <sub>dec</sub> )
F900:06	Cycle time	current cycle time <b>Unit:</b> 1 µs	UINT16	RO	0x0000 (0 <sub>dec</sub> )

**Index FB40 Memory interface**

Index (hex)	Name	Meaning	Data type	Flags	Default
FB40:0	Memory interface	General information for the modular device profile	UINT8	RO	0x03 (3 <sub>dec</sub> )
FB40:01	Address	reserved	UINT32	RW	0x00000000 (0 <sub>dec</sub> )
FB40:02	Length	reserved	UINT16	RW	0x0000 (0 <sub>dec</sub> )
FB40:03	Data	reserved	OCTET STRING[8]	RW	{0}

**7.2.8 Standard objects (0x1000-0x1FFF)**

The standard objects have the same meaning for all EtherCAT slaves.

**Index 1000 Device type**

Index (hex)	Name	Meaning	Data type	Flags	Default
1000:0	Device type	Device type of the EtherCAT slave: The Lo-Word contains the CoE profile used (5001). The Hi-Word contains the module profile according to the modular device profile.	UINT32	RO	0x00001389 (5001 <sub>dec</sub> )

**Index 1008 Device name**

Index (hex)	Name	Meaning	Data type	Flags	Default
1008:0	Device name	Device name of the EtherCAT slave	STRING	RO	EJ7037

**Index 1009 Hardware version**

Index (hex)	Name	Meaning	Data type	Flags	Default
1009:0	Hardware version	Hardware version of the EtherCAT slave	STRING	RO	00

**Index 100A Software version**

Index (hex)	Name	Meaning	Data type	Flags	Default
100A:0	Software version	Firmware version of the EtherCAT slave	STRING	RO	01

**Index 1018 Identity**

Index (hex)	Name	Meaning	Data type	Flags	Default
1018:0	Identity	Information for identifying the slave	UINT8	RO	0x04 (4 <sub>dec</sub> )
1018:01	Vendor ID	Vendor ID of the EtherCAT slave	UINT32	RO	0x00000002 (2 <sub>dec</sub> )
1018:02	Product code	Product code of the EtherCAT slave	UINT32	RO	0x1B7D2852 (461187154 <sub>dec</sub> )
1018:03	Revision	Revision number of the EtherCAT slave; the Low Word (bit 0-15) indicates the special terminal number, the High Word (bit 16-31) refers to the device description	UINT32	RO	0x00000000 (0 <sub>dec</sub> )
1018:04	Serial number	Serial number of the EtherCAT slave; the Low Byte (bit 0-7) of the Low Word contains the year of production, the High Byte (bit 8-15) of the Low Word contains the week of production, the High Word (bit 16-31) is 0	UINT32	RO	0x00000000 (0 <sub>dec</sub> )

**Index 10F0 Backup parameter handling**

Index (hex)	Name	Meaning	Data type	Flags	Default
10F0:0	Backup parameter handling	Information for standardized loading and saving of backup entries	UINT8	RO	0x01 (1 <sub>dec</sub> )
10F0:01	Checksum	Checksum across all backup entries of the EtherCAT slave	UINT32	RO	0x00000000 (0 <sub>dec</sub> )

**Index 10F3 Diagnosis History**

Index (hex)	Name	Meaning	Data type	Flags	Default
10F3:0	Diagnosis History	Max. Subindex	UINT8	RO	0x37 (55 <sub>dec</sub> )
10F3:01	Maximum Messages	Maximum number of stored messages. A maximum of 16 messages can be stored	UINT32	RO	0x00000000 (0 <sub>dec</sub> )
10F3:02	Newest Message	Subindex of the latest message	UINT8	RO	0x00 (0 <sub>dec</sub> )
10F3:03	Newest Acknowledged Message	Subindex of the last confirmed message	UINT8	RO	0x00 (0 <sub>dec</sub> )
10F3:04	New Message available	Indicates that a new message is available	BOOLEAN	RO	0x00 (0 <sub>dec</sub> )
10F3:05	Flags	not used	UINT16	RO	0x0000 (0 <sub>dec</sub> )
10F3:06	Diagnosis Message 001	Message 1	OCTET STRING[28]	RO	{0}
...	...	...	...	...	...
10F3:37	Diagnosis Message 050	Message 50	OCTET STRING[28]	RO	{0}

**Index 10F8 Actual Time Stamp**

Index (hex)	Name	Meaning	Data type	Flags	Default
10F8:0	Actual Time Stamp	Timestamp	UINT64	RO	



**Index 1400 ENC RxPDO-Par Control compact**

Index (hex)	Name	Meaning	Data type	Flags	Default
1400:0	ENC RxPDO-Par Control compact	PDO Parameter RxPDO 1	UINT8	RO	0x06 (6 <sub>dec</sub> )
1400:06	Exclude RxPDOs	Specifies the RxPDOs (index of RxPDO mapping objects) that must not be transferred together with RxPDO 1.	OCTET-STRING[6]	RO	01 16 00 00 00 00

**Index 1401 ENC RxPDO-Par Control**

Index (hex)	Name	Meaning	Data type	Flags	Default
1401:0	ENC RxPDO-Par Control	PDO Parameter RxPDO 2	UINT8	RO	0x06 (6 <sub>dec</sub> )
1401:06	Exclude RxPDOs	Specifies the RxPDOs (index of RxPDO mapping objects) that must not be transferred together with RxPDO 2.	OCTET-STRING[6]	RO	00 16 00 00 00 00

**Index 1403 STM RxPDO-Par Position**

Index (hex)	Name	Meaning	Data type	Flags	Default
1403:0	STM RxPDO-Par Position	PDO Parameter RxPDO 4	UINT8	RO	0x06 (6 <sub>dec</sub> )
1403:06	Exclude RxPDOs	Specifies the RxPDOs (index of RxPDO mapping objects) that must not be transferred together with RxPDO 4.	OCTET-STRING[6]	RO	04 16 05 16 06 16

**Index 1404 STM RxPDO-Par Velocity**

Index (hex)	Name	Meaning	Data type	Flags	Default
1404:0	STM RxPDO-Par Velocity	PDO Parameter RxPDO 5	UINT8	RO	0x06 (6 <sub>dec</sub> )
1404:06	Exclude RxPDOs	Specifies the RxPDOs (index of RxPDO mapping objects) that must not be transferred together with RxPDO 5.	OCTET-STRING[6]	RO	03 16 05 16 06 16

**Index 1405 POS RxPDO-Par Control compact**

Index (hex)	Name	Meaning	Data type	Flags	Default
1405:0	POS RxPDO-Par Control compact	PDO Parameter RxPDO 6	UINT8	RO	0x06 (6 <sub>dec</sub> )
1405:06	Exclude RxPDOs	Specifies the RxPDOs (index of RxPDO mapping objects) that must not be transferred together with RxPDO 6.	OCTET-STRING[6]	RO	03 16 04 16 06 16

**Index 1406 POS RxPDO-Par Control**

Index (hex)	Name	Meaning	Data type	Flags	Default
1406:0	POS RxPDO-Par Control	PDO Parameter RxPDO 7	UINT8	RO	0x06 (6 <sub>dec</sub> )
1406:06	Exclude RxPDOs	Specifies the RxPDOs (index of RxPDO mapping objects) that must not be transferred together with RxPDO 7.	OCTET-STRING[6]	RO	03 16 04 16 05 16

**Index 1407 POS RxPDO-Par Control 2**

Index (hex)	Name	Meaning	Data type	Flags	Default
1407:0	POS RxPDO-Par Control 2	PDO Parameter RxPDO 8	UINT8	RO	0x06 (6 <sub>dec</sub> )
1407:06	Exclude RxPDOs	Specifies the RxPDOs (index of RxPDO mapping objects) that must not be transferred together with RxPDO 8	OCTET-STRING[6]	RO	03 16 04 16 05 16

**Index 1600 ENC RxPDO-Map Control compact**

Index (hex)	Name	Meaning	Data type	Flags	Default
1600:0	ENC RxPDO-Map Control compact	PDO Mapping RxPDO 1	UINT8	RO	0x06 (6 <sub>dec</sub> )
1600:01	SubIndex 001	1. PDO Mapping entry (object 0x7000 (ENC Outputs Ch.1), entry 0x01 (Enable latch C))	UINT32	RO	0x7000:01, 1
1600:02	SubIndex 002	2. PDO Mapping entry (object 0x7000 (ENC Outputs Ch.1), entry 0x02 (Enable latch extern on positive edge))	UINT32	RO	0x7000:02, 1
1600:03	SubIndex 003	3. PDO Mapping entry (object 0x7000 (ENC Outputs Ch.1), entry 0x03 (Set counter))	UINT32	RO	0x7000:03, 1
1600:04	SubIndex 004	4. PDO Mapping entry (object 0x7000 (ENC Outputs Ch.1), entry 0x04 (Enable latch extern on negative edge))	UINT32	RO	0x7000:04, 1
1600:05	SubIndex 005	5. PDO Mapping entry (12 bits align)	UINT32	RO	0x0000:00, 12
1600:06	SubIndex 006	6. PDO Mapping entry (object 0x7000 (ENC Outputs Ch.1), entry 0x11 (Set counter value))	UINT32	RO	0x7000:11, 16

**Index 1601 ENC RxPDO-Map Control**

Index (hex)	Name	Meaning	Data type	Flags	Default
1601:0	ENC RxPDO-Map Control	PDO Mapping RxPDO 2	UINT8	RO	0x06 (6 <sub>dec</sub> )
1601:01	SubIndex 001	1. PDO Mapping entry (object 0x7000 (ENC Outputs Ch.1), entry 0x01 (Enable latch C))	UINT32	RO	0x7000:01, 1
1601:02	SubIndex 002	2. PDO Mapping entry (object 0x7000 (ENC Outputs Ch.1), entry 0x02 (Enable latch extern on positive edge))	UINT32	RO	0x7000:02, 1
1601:03	SubIndex 003	3. PDO Mapping entry (object 0x7000 (ENC Outputs Ch.1), entry 0x03 (Set counter))	UINT32	RO	0x7000:03, 1
1601:04	SubIndex 004	4. PDO Mapping entry (object 0x7000 (ENC Outputs Ch.1), entry 0x04 (Enable latch extern on negative edge))	UINT32	RO	0x7000:04, 1
1601:05	SubIndex 005	5. PDO Mapping entry (12 bits align)	UINT32	RO	0x0000:00, 12
1601:06	SubIndex 006	6. PDO Mapping entry (object 0x7000 (ENC Outputs Ch.1), entry 0x11 (Set counter value))	UINT32	RO	0x7000:11, 32

**Index 1602 STM RxPDO-Map Control**

Index (hex)	Name	Meaning	Data type	Flags	Default
1602:0	STM RxPDO-Map Control	PDO Mapping RxPDO 3	UINT8	RO	0x06 (6 <sub>dec</sub> )
1602:01	SubIndex 001	1. PDO Mapping entry (object 0x7010 (STM Outputs Ch.1), entry 0x01 (Enable))	UINT32	RO	0x7010:01, 1
1602:02	SubIndex 002	2. PDO Mapping entry (object 0x7010 (STM Outputs Ch.1), entry 0x02 (Reset))	UINT32	RO	0x7010:02, 1
1602:03	SubIndex 003	3. PDO Mapping entry (object 0x7010 (STM Outputs Ch.1), entry 0x03 (Reduce torque))	UINT32	RO	0x7010:03, 1
1602:04	SubIndex 004	4. PDO Mapping entry (8 bits align)	UINT32	RO	0x0000:00, 8
1602:05	SubIndex 005	5. PDO Mapping entry (object 0x7010 (STM Outputs Ch.1), entry 0x0C (Digital output 1))	UINT32	RO	0x7010:0C, 1
1602:06	SubIndex 006	6. PDO Mapping entry (4 bits align)	UINT32	RO	0x0000:00, 4

**Index 1603 STM RxPDO-Map Position**

Index (hex)	Name	Meaning	Data type	Flags	Default
1603:0	STM RxPDO-Map Position	PDO Mapping RxPDO 4	UINT8	RO	0x01 (1 <sub>dec</sub> )
1603:01	SubIndex 001	1. PDO Mapping entry (object 0x7010 (STM Outputs Ch.1), entry 0x11 (Position))	UINT32	RO	0x7010:11, 32

**Index 1604 STM RxPDO-Map Velocity**

Index (hex)	Name	Meaning	Data type	Flags	Default
1604:0	STM RxPDO-Map Velocity	PDO Mapping RxPDO 5	UINT8	RO	0x01 (1 <sub>dec</sub> )
1604:01	SubIndex 001	1. PDO Mapping entry (object 0x7010 (STM Outputs Ch.1), entry 0x21 (Velocity))	UINT32	RO	0x7010:21, 16

**Index 1605 POS RxPDO-Map Control compact**

Index (hex)	Name	Meaning	Data type	Flags	Default
1605:0	POS RxPDO-Map Control compact	PDO Mapping RxPDO 6	UINT8	RO	0x04 (4 <sub>dec</sub> )
1605:01	SubIndex 001	1. PDO Mapping entry (object 0x7020 (POS Outputs Ch.1), entry 0x01 (Execute))	UINT32	RO	0x7020:01, 1
1605:02	SubIndex 002	2. PDO Mapping entry (object 0x7020 (POS Outputs Ch.1), entry 0x02 (Emergency stop))	UINT32	RO	0x7020:02, 1
1605:03	SubIndex 003	3. PDO Mapping entry (14 bits align)	UINT32	RO	0x0000:00, 14
1605:04	SubIndex 004	4. PDO Mapping entry (object 0x7020 (POS Outputs Ch.1), entry 0x11 (Target position))	UINT32	RO	0x7020:11, 32

**Index 1606 POS RxPDO-Map Control**

Index (hex)	Name	Meaning	Data type	Flags	Default
1606:0	POS RxPDO-Map Control	PDO Mapping RxPDO 7	UINT8	RO	0x08 (8 <sub>dec</sub> )
1606:01	SubIndex 001	1. PDO Mapping entry (object 0x7020 (POS Outputs Ch.1), entry 0x01 (Execute))	UINT32	RO	0x7020:01, 1
1606:02	SubIndex 002	2. PDO Mapping entry (object 0x7020 (POS Outputs Ch.1), entry 0x02 (Emergency stop))	UINT32	RO	0x7020:02, 1
1606:03	SubIndex 003	3. PDO Mapping entry (14 bits align)	UINT32	RO	0x0000:00, 14
1606:04	SubIndex 004	4. PDO Mapping entry (object 0x7020 (POS Outputs Ch.1), entry 0x11 (Target position))	UINT32	RO	0x7020:11, 32
1606:05	SubIndex 005	5. PDO Mapping entry (object 0x7020 (POS Outputs Ch.1), entry 0x21 (Velocity))	UINT32	RO	0x7020:21, 16
1606:06	SubIndex 006	6. PDO Mapping entry (object 0x7020 (POS Outputs Ch.1), entry 0x22 (Start type))	UINT32	RO	0x7020:22, 16
1606:07	SubIndex 007	7. PDO Mapping entry (object 0x7020 (POS Outputs Ch.1), entry 0x23 (Acceleration))	UINT32	RO	0x7020:23, 16
1606:08	SubIndex 008	8. PDO Mapping entry (object 0x7020 (POS Outputs Ch.1), entry 0x24 (Deceleration))	UINT32	RO	0x7020:24, 16

**Index 1607 POS RxPDO-Map Control 2**

Index (hex)	Name	Meaning	Data type	Flags	Default
1607:0	POS RxPDO-Map Control 2	PDO Mapping RxPDO 8	UINT8	RO	0x08 (8 <sub>dec</sub> )
1607:01	SubIndex 001	1. PDO Mapping entry (2 bits align)	UINT32	RO	0x0000:00,2
1607:02	SubIndex 002	2. PDO Mapping entry (object 0x7021 (POS Outputs 2 Ch.1), entry 0x03 (Enable auto start))	UINT32	RO	0x7021:03, 1
1607:03	SubIndex 003	3. PDO Mapping entry (13 bits align)	UINT32	RO	0x0000:00, 13
1607:04	SubIndex 004	4. PDO Mapping entry (object 0x7021 (POS Outputs 2 Ch.1), entry 0x11 (Target position))	UINT32	RO	0x7021:11, 32
1607:05	SubIndex 005	5. PDO Mapping entry (object 0x7021 (POS Outputs 2 Ch.1), entry 0x21 (Velocity))	UINT32	RO	0x7021:21, 16
1607:06	SubIndex 006	6. PDO Mapping entry (object 0x7021 (POS Outputs 2 Ch.1), entry 0x22 (Start type))	UINT32	RO	0x7021:22, 16
1607:07	SubIndex 007	7. PDO Mapping entry (object 0x7021 (POS Outputs 2 Ch.1), entry 0x23 (Acceleration))	UINT32	RO	0x7021:23, 16
1607:08	SubIndex 008	8. PDO Mapping entry (object 0x7021 (POS Outputs 2 Ch.1), entry 0x24 (Deceleration))	UINT32	RO	0x7021:24, 16

**Index 1800 ENC TxPDO-Par Status compact**

Index (hex)	Name	Meaning	Data type	Flags	Default
1800:0	ENC TxPDO-Par Status compact	PDO parameter TxPDO 1	UINT8	RO	0x06 (6 <sub>dec</sub> )
1800:06	Exclude TxPDOs	Specifies the TxPDOs (index of TxPDO mapping objects) that must not be transferred together with TxPDO 1	OCTET-STRING[2]	RO	01 1A

**Index 1801 ENC TxPDO-Par Status**

Index (hex)	Name	Meaning	Data type	Flags	Default
1801:0	ENC TxPDO-Par Status	PDO parameter TxPDO 2	UINT8	RO	0x06 (6 <sub>dec</sub> )
1801:06	Exclude TxPDOs	Specifies the TxPDOs (index of TxPDO mapping objects) that must not be transferred together with TxPDO 2.	OCTET-STRING[2]	RO	00 1A

**Index 1806 POS TxPDO-Par Status compact**

Index (hex)	Name	Meaning	Data type	Flags	Default
1806:0	POS TxPDO-Par Status compact	PDO parameter TxPDO 7	UINT8	RO	0x06 (6 <sub>dec</sub> )
1806:06	Exclude TxPDOs	Specifies the TxPDOs (index of TxPDO mapping objects) that must not be transferred together with TxPDO 7.	OCTET-STRING[2]	RO	07 1A

**Index 1807 POS TxPDO-Par Status**

Index (hex)	Name	Meaning	Data type	Flags	Default value
1807:0	POS TxPDO-Par Status	PDO parameter TxPDO 8	UINT8	RO	0x06 (6 <sub>dec</sub> )
1807:06	Exclude TxPDOs	Specifies the TxPDOs (index of TxPDO mapping objects) that must not be transferred together with TxPDO 8.	OCTET-STRING[2]	RO	06 1A

## Index 1A00 ENC TxPDO-Map Status compact

Index (hex)	Name	Meaning	Data type	Flags	Default
1A00:0	ENC TxPDO-Map Status compact	PDO Mapping TxPDO 1	UINT8	RO	0x11 (17 <sub>dec</sub> )
1A00:01	SubIndex 001	1. PDO Mapping entry (object 0x6000 (ENC Inputs Ch. 1), entry 0x01 (Latch C valid))	UINT32	RO	0x6000:01, 1
1A00:02	SubIndex 002	2. PDO Mapping entry (object 0x6000 (ENC Inputs Ch. 1), entry 0x02 (Latch extern valid))	UINT32	RO	0x6000:02, 1
1A00:03	SubIndex 003	3. PDO Mapping entry (object 0x6000 (ENC Inputs Ch. 1), entry 0x03 (Set counter done))	UINT32	RO	0x6000:03, 1
1A00:04	SubIndex 004	4. PDO Mapping entry (object 0x6000 (ENC Inputs Ch. 1), entry 0x04 (Counter underflow))	UINT32	RO	0x6000:04, 1
1A00:05	SubIndex 005	5. PDO Mapping entry (object 0x6000 (ENC Inputs Ch. 1), entry 0x05 (Counter overflow))	UINT32	RO	0x6000:05, 1
1A00:06	SubIndex 006	6. PDO Mapping entry (2 bits align)	UINT32	RO	0x0000:00, 2
1A00:07	SubIndex 007	7. PDO Mapping entry (object 0x6000 (ENC Inputs Ch. 1), entry 0x08 (Extrapolation stall))	UINT32	RO	0x6000:08, 1
1A00:08	SubIndex 008	8. PDO Mapping entry (object 0x6000 (ENC Inputs Ch. 1), entry 0x09 (Status of input A))	UINT32	RO	0x6000:09, 1
1A00:09	SubIndex 009	9. PDO Mapping entry (object 0x6000 (ENC Inputs Ch. 1), entry 0x0A (Status of input B))	UINT32	RO	0x6000:0A, 1
1A00:0A	SubIndex 010	10. PDO Mapping entry (object 0x6000 (ENC Inputs Ch. 1), entry 0x0B (Status of input C))	UINT32	RO	0x6000:0B, 1
1A00:0B	SubIndex 011	11. PDO Mapping entry (1 bit align)	UINT32	RO	0x0000:00, 1
1A00:0C	SubIndex 012	12. PDO Mapping entry (object 0x6000 (ENC Inputs Ch. 1), entry 0x0D (Status of extern latch))	UINT32	RO	0x6000:0D, 1
1A00:0D	SubIndex 013	13. PDO Mapping entry (object 0x6000 (ENC Inputs Ch. 1), entry 0x0E (Sync error))	UINT32	RO	0x6000:0E, 1
1A00:0E	SubIndex 014	14. PDO Mapping entry (1 bits align)	UINT32	RO	0x0000:00, 1
1A00:0F	SubIndex 015	15. PDO Mapping entry (object 0x6000 (ENC Inputs Ch. 1), entry 0x10 (TxPDO Toggle))	UINT32	RO	0x6000:10, 1
1A00:10	SubIndex 016	16. PDO Mapping entry (object 0x6000 (ENC Inputs Ch. 1), entry 0x11 (Counter value))	UINT32	RO	0x6000:11, 16
1A00:11	SubIndex 017	17. PDO Mapping entry (object 0x6000 (ENC Inputs Ch. 1), entry 0x12 (Latch value))	UINT32	RO	0x6000:12, 16

**Index 1A01 ENC TxPDO-Map Status**

Index (hex)	Name	Meaning	Data type	Flags	Default
1A01:0	ENC TxPDO-Map Status compact	PDO Mapping TxPDO 1	UINT8	RO	0x11 (17 <sub>dec</sub> )
1A01:01	SubIndex 001	1. PDO Mapping entry (object 0x6000 (ENC Inputs Ch. 1), entry 0x01 (Latch C valid))	UINT32	RO	0x6000:01, 1
1A01:02	SubIndex 002	2. PDO Mapping entry (object 0x6000 (ENC Inputs Ch. 1), entry 0x02 (Latch extern valid))	UINT32	RO	0x6000:02, 1
1A01:03	SubIndex 003	3. PDO Mapping entry (object 0x6000 (ENC Inputs Ch. 1), entry 0x03 (Set counter done))	UINT32	RO	0x6000:03, 1
1A01:04	SubIndex 004	4. PDO Mapping entry (object 0x6000 (ENC Inputs Ch. 1), entry 0x04 (Counter underflow))	UINT32	RO	0x6000:04, 1
1A01:05	SubIndex 005	5. PDO Mapping entry (object 0x6000 (ENC Inputs Ch. 1), entry 0x05 (Counter overflow))	UINT32	RO	0x6000:05, 1
1A01:06	SubIndex 006	6. PDO Mapping entry (2 bits align)	UINT32	RO	0x0000:00, 2
1A01:07	SubIndex 007	7. PDO Mapping entry (object 0x6000 (ENC Inputs Ch. 1), entry 0x08 (Extrapolation stall))	UINT32	RO	0x6000:08, 1
1A01:08	SubIndex 008	8. PDO Mapping entry (object 0x6000 (ENC Inputs Ch. 1), entry 0x09 (Status of input A))	UINT32	RO	0x6000:09, 1
1A01:09	SubIndex 009	9. PDO Mapping entry (object 0x6000 (ENC Inputs Ch. 1), entry 0x0A (Status of input B))	UINT32	RO	0x6000:0A, 1
1A01:0A	SubIndex 010	10. PDO Mapping entry (object 0x6000 (ENC Inputs Ch. 1), entry 0x0B (Status of input C))	UINT32	RO	0x6000:0B, 1
1A01:0B	SubIndex 011	11. PDO Mapping entry (1 bit align)	UINT32	RO	0x0000:00, 1
1A01:0C	SubIndex 012	12. PDO Mapping entry (object 0x6000 (ENC Inputs Ch. 1), entry 0x0D (Status of extern latch))	UINT32	RO	0x6000:0D, 1
1A01:0D	SubIndex 013	13. PDO Mapping entry (object 0x6000 (ENC Inputs Ch. 1), entry 0x0E (Sync error))	UINT32	RO	0x6000:0E, 1
1A01:0E	SubIndex 014	14. PDO Mapping entry (1 bit align)	UINT32	RO	0x0000:00, 1
1A01:0F	SubIndex 015	15. PDO Mapping entry (object 0x6000 (ENC Inputs Ch. 1), entry 0x10 (TxPDO Toggle))	UINT32	RO	0x6000:10, 1
1A01:10	SubIndex 016	16. PDO Mapping entry (object 0x6000 (ENC Inputs Ch. 1), entry 0x11 (Counter value))	UINT32	RO	0x6000:11, 32
1A01:11	SubIndex 017	17. PDO Mapping entry (object 0x6000 (ENC Inputs Ch. 1), entry 0x12 (Latch value))	UINT32	RO	0x6000:12, 32

**Index 1A02 ENC TxPDO-Map Timest. compact**

Index (hex)	Name	Meaning	Data type	Flags	Default
1A02:0	ENC TxPDO-Map Timest. compact	PDO Mapping TxPDO 3	UINT8	RO	0x01 (1 <sub>dec</sub> )
1A02:01	SubIndex 001	1. PDO Mapping entry (object 0x6000 (ENC Inputs Ch.1), entry 0x16 (Timestamp))	UINT32	RO	0x6000:16, 32

**Index 1A03 STM TxPDO-Map Status**

Index (hex)	Name	Meaning	Data type	Flags	Default
1A03:0	STM TxPDO-Map Status	PDO Mapping TxPDO 4	UINT8	RO	0x0E (14 <sub>dec</sub> )
1A03:01	SubIndex 001	1. PDO Mapping entry (object 0x6010 (STM Inputs Ch.1), entry 0x01 (Ready to enable))	UINT32	RO	0x6010:01, 1
1A03:02	SubIndex 002	2. PDO Mapping entry (object 0x6010 (STM Inputs Ch.1), entry 0x02 (Ready))	UINT32	RO	0x6010:02, 1
1A03:03	SubIndex 003	3. PDO Mapping entry (object 0x6010 (STM Inputs Ch.1), entry 0x03 (Warning))	UINT32	RO	0x6010:03, 1
1A03:04	SubIndex 004	4. PDO Mapping entry (object 0x6010 (STM Inputs Ch.1), entry 0x04 (Error))	UINT32	RO	0x6010:04, 1
1A03:05	SubIndex 005	5. PDO Mapping entry (object 0x6010 (STM Inputs Ch.1), entry 0x05 (Moving positive))	UINT32	RO	0x6010:05, 1
1A03:06	SubIndex 006	6. PDO Mapping entry (object 0x6010 (STM Inputs Ch.1), entry 0x06 (Moving negative))	UINT32	RO	0x6010:06, 1
1A03:07	SubIndex 007	7. PDO Mapping entry (object 0x6010 (STM Inputs Ch.1), entry 0x07 (Torque reduced))	UINT32	RO	0x6010:07, 1
1A03:08	SubIndex 008	8. PDO Mapping entry (object 0x6010 (STM Inputs Ch.1), entry 0x08 (Motor stall))	UINT32	RO	0x6010:08, 1
1A03:09	SubIndex 009	9. PDO Mapping entry (3 bits align)	UINT32	RO	0x0000:00, 3
1A03:0A	SubIndex 010	10. PDO Mapping entry (object 0x6010 (STM Inputs Ch.1), entry 0x0C (Digital input 1))	UINT32	RO	0x6010:0C, 1
1A03:0B	SubIndex 011	11. PDO Mapping entry (object 0x6010 (STM Inputs Ch.1), entry 0x0D (Digital input 2))	UINT32	RO	0x6010:0D, 1
1A03:0C	SubIndex 012	12. PDO Mapping entry (object 0x6010 (STM Inputs Ch.1), entry 0x0E (Sync error))	UINT32	RO	0x6010:0E, 1
1A03:0D	SubIndex 013	13. PDO Mapping entry (1 bit align)	UINT32	RO	0x0000:00, 1
1A03:0E	SubIndex 014	14. PDO Mapping entry (object 0x6010 (STM Inputs Ch.1), entry 0x10 (TxPDO Toggle))	UINT32	RO	0x6010:10, 1

**Index 1A04 STM TxPDO-Map Synchron info data**

Index (hex)	Name	Meaning	Data type	Flags	Default
1A04:0	STM TxPDO-Map Synchron info data	PDO Mapping TxPDO 5	UINT8	RO	0x02 (2 <sub>dec</sub> )
1A04:01	SubIndex 001	1. PDO Mapping entry (object 0x6010 (STM Inputs Ch.1), entry 0x11 (Info data 1))	UINT32	RO	0x6010:11, 16
1A04:02	SubIndex 002	2. PDO Mapping entry (object 0x6010 (STM Inputs Ch.1), entry 0x12 (Info data 2))	UINT32	RO	0x6010:12, 16

**Index 1A05 STM TxPDO-Map Motor load**

Index (hex)	Name	Meaning	Data type	Flags	Default
1A05:0	STM TxPDO-Map Motor load	PDO Mapping TxPDO 6	UINT8	RO	0x01 (1 <sub>dec</sub> )
1A05:01	SubIndex 001	1. PDO Mapping entry (object 0x6010 (STM Inputs Ch.1), entry 0x13 (Motor load))	UINT32	RO	0x6010:13, 16



**Index 1A06 POS TxPDO-Map Status compact**

Index (hex)	Name	Meaning	Data type	Flags	Default
1A06:0	POS TxPDO-Map Status compact	PDO Mapping TxPDO 7	UINT8	RO	0x09 (9 <sub>dec</sub> )
1A06:01	SubIndex 001	1. PDO Mapping entry (object 0x6020 (POS Inputs Ch.1), entry 0x01 (Busy))	UINT32	RO	0x6020:01, 1
1A06:02	SubIndex 002	2. PDO Mapping entry (object 0x6020 (POS Inputs Ch.1), entry 0x02 (In target))	UINT32	RO	0x6020:02, 1
1A06:03	SubIndex 003	3. PDO Mapping entry (object 0x6020 (POS Inputs Ch.1), entry 0x03 (Warning))	UINT32	RO	0x6020:03, 1
1A06:04	SubIndex 004	4. PDO Mapping entry (object 0x6020 (POS Inputs Ch.1), entry 0x04 (Error))	UINT32	RO	0x6020:04, 1
1A06:05	SubIndex 005	5. PDO Mapping entry (object 0x6020 (POS Inputs Ch.1), entry 0x05 (Calibrated))	UINT32	RO	0x6020:05, 1
1A06:06	SubIndex 006	6. PDO Mapping entry (object 0x6020 (POS Inputs Ch.1), entry 0x06 (Accelerate))	UINT32	RO	0x6020:06, 1
1A06:07	SubIndex 007	7. PDO Mapping entry (object 0x6020 (POS Inputs Ch.1), entry 0x07 (Decelerate))	UINT32	RO	0x6020:07, 1
1A06:08	SubIndex 008	8. PDO Mapping entry (object 0x6020 (POS Inputs Ch.1), entry 0x08 (Ready to execute))	UINT32	RO	0x6020:08, 1
1A06:09	SubIndex 009	9. PDO Mapping entry (8 bits align)	UINT32	RO	0x0000:00, 8

**Index 1A07 POS TxPDO-Map Status**

Index (hex)	Name	Meaning	Data type	Flags	Default
1A07:0	POS TxPDO-Map Status	PDO Mapping TxPDO 8	UINT8	RO	0x0C (12 <sub>dec</sub> )
1A07:01	SubIndex 001	1. PDO Mapping entry (object 0x6020 (POS Inputs Ch.1), entry 0x01 (Busy))	UINT32	RO	0x6020:01, 1
1A07:02	SubIndex 002	2. PDO Mapping entry (object 0x6020 (POS Inputs Ch.1), entry 0x02 (In target))	UINT32	RO	0x6020:02, 1
1A07:03	SubIndex 003	3. PDO Mapping entry (object 0x6020 (POS Inputs Ch.1), entry 0x03 (Warning))	UINT32	RO	0x6020:03, 1
1A07:04	SubIndex 004	4. PDO Mapping entry (object 0x6020 (POS Inputs Ch.1), entry 0x04 (Error))	UINT32	RO	0x6020:04, 1
1A07:05	SubIndex 005	5. PDO Mapping entry (object 0x6020 (POS Inputs Ch.1), entry 0x05 (Calibrated))	UINT32	RO	0x6020:05, 1
1A07:06	SubIndex 006	6. PDO Mapping entry (object 0x6020 (POS Inputs Ch.1), entry 0x06 (Accelerate))	UINT32	RO	0x6020:06, 1
1A07:07	SubIndex 007	7. PDO Mapping entry (object 0x6020 (POS Inputs Ch.1), entry 0x07 (Decelerate))	UINT32	RO	0x6020:07, 1
1A07:08	SubIndex 008	8. PDO Mapping entry (object 0x6020 (POS Inputs Ch.1), entry 0x08 (Ready to execute))	UINT32	RO	0x6020:08, 1
1A07:09	SubIndex 009	9. PDO Mapping entry (8 bits align)	UINT32	RO	0x0000:00, 8
1A07:0A	SubIndex 010	10. PDO Mapping entry (object 0x6020 (POS Inputs Ch.1), entry 0x11 (Actual position))	UINT32	RO	0x6020:11, 32
1A07:0B	SubIndex 011	11. PDO Mapping entry (object 0x6020 (POS Inputs Ch.1), entry 0x21 (Actual velocity))	UINT32	RO	0x6020:21, 16
1A07:0C	SubIndex 012	12. PDO Mapping entry (object 0x6020 (POS Inputs Ch.1), entry 0x22 (Actual drive time))	UINT32	RO	0x6020:22, 32

**Index 1A08 STM TxPDO-Map Internal position**

Index (hex)	Name	Meaning	Data type	Flags	Default
1A08:0	STM TxPDO-Map Internal position	PDO Mapping TxPDO 9	UINT8	RO	0x01 (1 <sub>dec</sub> )
1A08:01	SubIndex 001	1. PDO Mapping entry (object 0x6010 (STM Inputs Ch.1), entry 0x14 (Internal position))	UINT32	RO	0x6010:14, 32

**Index 1A09 STM TxPDO-Map External position**

Index (hex)	Name	Meaning	Data type	Flags	Default
1A09:0	STM TxPDO-Map External position	PDO Mapping TxPDO 10	UINT8	RO	0x01 (1 <sub>dec</sub> )
1A09:01	SubIndex 001	1. PDO Mapping entry (object 0x6010 (STM Inputs Ch.1), entry 0x15 (External position))	UINT32	RO	0x6010:15, 32

**Index 1A0A POS TxPDO-Map Actual position lag**

Index (hex)	Name	Meaning	Data type	Flags	Default
1A0A:0	POS TxPDO-Map Actual position lag	PDO Mapping TxPDO 11	UINT8	RO	0x01 (1 <sub>dec</sub> )
1A0A:01	SubIndex 001	1. PDO Mapping entry (object 0x6020 (POS Inputs Ch.1), entry 0x23 (Actual position lag))	UINT32	RO	0x6020:23, 32

**Index 1C00 Sync manager type**

Index (hex)	Name	Meaning	Data type	Flags	Default
1C00:0	Sync manager type	Using the Sync Managers	UINT8	RO	0x04 (4 <sub>dec</sub> )
1C00:01	SubIndex 001	Sync-Manager Type Channel 1: Mailbox Write	UINT8	RO	0x01 (1 <sub>dec</sub> )
1C00:02	SubIndex 002	Sync-Manager Type Channel 2: Mailbox Read	UINT8	RO	0x02 (2 <sub>dec</sub> )
1C00:03	SubIndex 003	Sync-Manager Type Channel 3: Process Data Write (Outputs)	UINT8	RO	0x03 (3 <sub>dec</sub> )
1C00:04	SubIndex 004	Sync-Manager Type Channel 4: Process Data Read (Inputs)	UINT8	RO	0x04 (4 <sub>dec</sub> )

**Index 1C12 RxPDO assign**

Index (hex)	Name	Meaning	Data type	Flags	Default
1C12:0	RxPDO assign	Using the Sync Managers	UINT8	RW	0x03 (3 <sub>dec</sub> )
1C12:01	SubIndex 001	1. allocated RxPDO (contains the index of the associated RxPDO mapping object)	UINT16	RW	0x1600 (5632 <sub>dec</sub> )
1C12:02	SubIndex 002	2. allocated RxPDO (contains the index of the associated RxPDO mapping object)	UINT16	RW	0x1602 (5634 <sub>dec</sub> )
1C12:03	SubIndex 003	3. allocated RxPDO (contains the index of the associated RxPDO mapping object)	UINT16	RW	0x1604 (5636 <sub>dec</sub> )

**Index 1C13 TxPDO assign**

Index (hex)	Name	Meaning	Data type	Flags	Default
1C13:0	TxPDO assign	PDO Assign Inputs	UINT8	RO	0x02 (2 <sub>dec</sub> )
1C13:01	SubIndex 001	1. allocated TxPDO (contains the index of the associated TxPDO mapping object)	UINT16	RO	0x1A00 (6656 <sub>dec</sub> )
1C13:02	SubIndex 002	2. allocated TxPDO (contains the index of the associated TxPDO mapping object)	UINT16	RO	0x1A03 (6659 <sub>dec</sub> )

**Index 1C32 SM output parameter**

Index (hex)	Name	Meaning	Data type	Flags	Default
1C32:0	SM output parameter	Synchronization parameters for the outputs	UINT8	RO	0x20 (32 <sub>dec</sub> )
1C32:01	Sync mode	Current synchronization mode: <ul style="list-style-type: none"> <li>• 0: Free Run</li> <li>• 1: Synchron with SM 2 Event</li> <li>• 2: DC-Mode - Synchron with SYNC0 Event</li> <li>• 3: DC-Mode - Synchron with SYNC1 Event</li> </ul>	UINT16	RW	0x0001 (1 <sub>dec</sub> )
1C32:02	Cycle time	Cycle time (in ns): <ul style="list-style-type: none"> <li>• Free Run: Cycle time of the local timer</li> <li>• Synchron with SM 2 Event: Master cycle time</li> <li>• DC mode: SYNC0/SYNC1 Cycle Time</li> </ul>	UINT32	RW	0x000F4240 (1000000 <sub>dec</sub> )
1C32:03	Shift time	Time between SYNC0 event and output of the outputs (in ns, DC mode only)	UINT32	RO	0x00000000 (0 <sub>dec</sub> )
1C32:04	Sync modes supported	Supported synchronization modes: <ul style="list-style-type: none"> <li>• Bit 0 = 1: free run is supported</li> <li>• Bit 1 = 1: Synchron with SM 2 Event is supported</li> <li>• Bit 2-3 = 01: DC mode is supported</li> <li>• Bit 4-5 = 10: Output Shift with SYNC1 event (only DC mode)</li> <li>• Bit 14 = 1: dynamic times (measurement through writing of 0x1C32:08)</li> </ul>	UINT16	RO	0x0807 (2055 <sub>dec</sub> )
1C32:05	Minimum cycle time	Minimum cycle time (in ns)	UINT32	RO	0x0003D090 (250000 <sub>dec</sub> )
1C32:06	Calc and copy time	Minimum time between SYNC0 and SYNC1 event (in ns, DC mode only)	UINT32	RO	0x00000000 (0 <sub>dec</sub> )
1C32:07	Minimum delay time	Min. time between SYNC1 event and output of the outputs (in ns, DC mode only)	UINT32	RO	0x00000000 (0 <sub>dec</sub> )
1C32:08	Command	<ul style="list-style-type: none"> <li>• 0: Measurement of the local cycle time is stopped</li> <li>• 1: Measurement of the local cycle time is started</li> </ul> Entries 0x1C32:03, 0x1C32:05, 0x1C32:06, 0x1C32:07, 0x1C32:09, 0x1C33:03, 0x1C33:06, 0x1C33:09 are updated with the maximum measured values. For a subsequent measurement the measured values are reset.	UINT16	RW	0x0000 (0 <sub>dec</sub> )
1C32:09	Maximum delay time	Max. time between SYNC1 event and output of the outputs (in ns, DC mode only)	UINT32	RO	0x00000000 (0 <sub>dec</sub> )
1C32:0B	SM event missed counter	Number of missed SM events in OPERATIONAL (DC mode only)	UINT16	RO	0x0000 (0 <sub>dec</sub> )
1C32:0C	Cycle exceeded counter	Number of occasions the cycle time was exceeded in OPERATIONAL (cycle was not completed in time or the next cycle began too early)	UINT16	RO	0x0000 (0 <sub>dec</sub> )
1C32:0D	Shift too short counter	Number of occasions that the interval between SYNC0 and SYNC1 event was too short (DC mode only)	UINT16	RO	0x0000 (0 <sub>dec</sub> )
1C32:14	Frame repeat time		UINT32	RW	0x00000000 (0 <sub>dec</sub> )
1C32:20	Sync error	The synchronization was not correct in the last cycle (outputs were output too late; DC mode only)	BOOLEAN	RO	0x00 (0 <sub>dec</sub> )

## Index 1C33 SM input parameter

Index (hex)	Name	Meaning	Data type	Flags	Default
1C33:0	SM input parameter	Synchronization parameters for the inputs	UINT8	RO	0x20 (32 <sub>dec</sub> )
1C33:01	Sync mode	Current synchronization mode: <ul style="list-style-type: none"> <li>0: Free Run</li> <li>1: Synchron with SM 3 Event (no outputs available)</li> <li>2: DC - Synchron with SYNC0 Event</li> <li>3: DC - Synchron with SYNC1 Event</li> <li>34: Synchron with SM 2 Event (outputs available)</li> </ul>	UINT16	RW	0x0022 (34 <sub>dec</sub> )
1C33:02	Cycle time	Cycle time (in ns): <ul style="list-style-type: none"> <li>Free Run: Cycle time of the local timer</li> <li>Synchron with SM 2 Event: Master cycle time</li> <li>DC mode: SYNC0/SYNC1 Cycle Time</li> </ul>	UINT32	RW	0x000F4240 (1000000 <sub>dec</sub> )
1C33:03	Shift time	Time between SYNC0 event and reading of the inputs (in ns, only DC mode)	UINT32	RO	0x00000000 (0 <sub>dec</sub> )
1C33:04	Sync modes supported	Supported synchronization modes: <ul style="list-style-type: none"> <li>Bit 0: free run is supported</li> <li>Bit 1: Synchron with SM 2 Event is supported (outputs available)</li> <li>Bit 1: Synchron with SM 3 Event is supported (no outputs available)</li> <li>Bit 2-3 = 01: DC mode is supported</li> <li>Bit 4-5 = 01: Input Shift through local event (outputs available)</li> <li>Bit 4-5 = 10: Input Shift with SYNC1 Event (no outputs available)</li> <li>Bit 14 = 1: dynamic times (measurement through writing of 0x1C33:08)</li> </ul>	UINT16	RO	0x0807 (2055 <sub>dec</sub> )
1C33:05	Minimum cycle time	Minimum cycle time (in ns)	UINT32	RO	0x0003D090 (250000 <sub>dec</sub> )
1C33:06	Calc and copy time	Time between reading of the inputs and availability of the inputs for the master (in ns, only DC mode)	UINT32	RO	0x0003D090 (250000 <sub>dec</sub> )
1C33:07	Minimum delay time	Min. time between SYNC1 event and the reading of the inputs (in ns, DC mode only)	UINT32	RO	0x00000000 (0 <sub>dec</sub> )
1C33:08	Command	With this entry the real required process data provision time can be measured. <ul style="list-style-type: none"> <li>0: Measurement of the local cycle time is stopped</li> <li>1: Measurement of the local cycle time is started</li> </ul> The entries 0x1C33:03, 0x1C33:06, 0x1C33:09 are updated with the maximum measured values. For a subsequent measurement the measured values are reset	UINT16	RW	0x0000 (0 <sub>dec</sub> )
1C33:09	Maximum Delay time	Time between SYNC1 event and reading of the inputs (in ns, only DC mode)	UINT32	RO	0x00000000 (0 <sub>dec</sub> )
1C33:0B	SM event missed counter	Number of missed SM events in OPERATIONAL (DC mode only)	UINT16	RO	0x0000 (0 <sub>dec</sub> )
1C33:0C	Cycle exceeded counter	Number of occasions the cycle time was exceeded in OPERATIONAL (cycle was not completed in time or the next cycle began too early)	UINT16	RO	0x0000 (0 <sub>dec</sub> )
1C33:0D	Shift too short counter	Number of occasions that the interval between SYNC0 and SYNC1 event was too short (DC mode only)	UINT16	RO	0x0000 (0 <sub>dec</sub> )
1C33:14	Frame repeat time		BOOLEAN	RO	0x00 (0 <sub>dec</sub> )
1C33:20	Sync error	The synchronization was not correct in the last cycle (outputs were output too late; DC mode only)	BOOLEAN	RO	0x00 (0 <sub>dec</sub> )

## 8 EJ7047 - Commissioning

### 8.1 Note on EL70x7 documentation

A detailed documentation for the commissioning of the EJ70x7 modules is in preparation.

#### NOTICE



##### Damage to devices or loss of data

The descriptions and instructions for commissioning the EL70x7 EtherCAT Terminals can be transferred to the EJ70x7 EtherCAT plug-in modules.

Before commissioning, read the detailed description of the process data, operation modes and parameterization in the [EL70x7](#) documentation.

### 8.2 EJ7047 - Object description and parameterization

#### ● EtherCAT XML Device Description



The display matches that of the CoE objects from the EtherCAT [XML](#) Device Description. We recommend downloading the latest XML file from the download area of the Beckhoff website and installing it according to installation instructions.

#### NOTICE



##### Parameterization via the CoE list (CAN over EtherCAT)

The EtherCAT device is parameterized via the CoE - Online tab (with a double click on the respective object) or via the Process Data tab (assignment of PDOs). A detailed description can be found in the EtherCAT System-Documentation in chapter "[EtherCAT subscriber configuration](#)"

Please note the general CoE notes in the EtherCAT System Documentation in chapter "[CoE-interface](#)" when using/manipulating the CoE parameters:

- Keep a startup list if components have to be replaced
- Differentiation between online/offline dictionary,
- existence of current XML description
- use "CoE reload" for resetting changes

#### NOTICE

##### Risk of damage to the device!

We strongly advise not to change settings in the CoE objects while the axis is active, since this could impair the control.

#### Introduction

The CoE overview contains objects for different intended applications:

- Objects required for parameterization during commissioning:
  - [Restore](#) [[▶ 68](#)] object index 0x1011
  - [Configuration data](#) [[▶ 68](#)] index 0x80nn
  - [Configuration data \(vendor-specific\)](#) [[▶ 72](#)] index 0xF80F
- Profile-specific objects:
  - [Input data](#) [[▶ 73](#)] index 0x60n0
  - [Output data](#) [[▶ 74](#)] index 0x70nn
  - [Information and diagnostic data](#) [[▶ 77](#)] Index 0x9010 .. 0xFB40
  - [Command object](#) [[▶ 72](#)] Index 0xFB00

- [Standard objects](#) [▶ 79]

The following section first describes the objects required for normal operation, followed by a complete overview of missing objects.

## 8.2.1 Restore object

### Index 1011 Restore default parameters

Index (hex)	Name	Meaning	Data type	Flags	Default
1011:0	Restore default parameters	Restore default parameters	UINT8	RO	0x01 (1 <sub>dec</sub> )
1011:01	SubIndex 001	If this object is set to "0x64616F6C" in the set value dialog, all backup objects are reset to their delivery state.	UINT32	RW	0x00000000 (0 <sub>dec</sub> )

## 8.2.2 Configuration data

### Index 8000 ENC Settings Ch.1

Index (hex)	Name	Meaning	Data type	Flags	Default
8000:0	ENC Settings Ch.1	Length of this object	UINT8	RO	0x0E (14 <sub>dec</sub> )
8000:08	Disable filter	Deactivates the input filters	BOOLEAN	RW	0x00 (0 <sub>dec</sub> )
8000:0A	Enable micro increments	The lower 8 bits of the counter value are extrapolated.	BOOLEAN	RW	0x00 (0 <sub>dec</sub> )
8000:0E	Reversion of rotation	Activates reversion of rotation of the encoder	BOOLEAN	RW	0x00 (0 <sub>dec</sub> )

### Index 8010 STM Motor Settings Ch.1

Index (hex)	Name	Meaning	Data type	Flags	Default
8010:0	STM Motor Settings Ch.1	Length of this object	UINT8	RO	0x11 (17 <sub>dec</sub> )
8010:01	Maximal current	Maximum permanent motor coil current <b>Unit:</b> 1 mA	UINT16	RW	0x1388 (5000 <sub>dec</sub> )
8010:02	Reduced current	reduced coil current <b>Unit:</b> 1 mA.	UINT16	RW	0x09C4 (2500 <sub>dec</sub> )
8010:03	Nominal voltage	Nominal voltage (supply voltage) of the motor <b>Unit:</b> 10 mV	UINT16	RW	0x1388 (5000 <sub>dec</sub> )
8010:04	Motor coil resistance	Internal resistance of the motor <b>Unit:</b> 10 mOhm	UINT16	RW	0x0064 (100 <sub>dec</sub> )
8010:05	Motor EMF	Countervoltage of the motor <b>Unit:</b> 1 mV / (rad/s)	UINT16	RW	0x0000 (0 <sub>dec</sub> )
8010:06	Motor fullsteps	Number of full motor steps	UINT16	RW	0x00C8 (200 <sub>dec</sub> )
8010:07	Encoder increments (4fold)	Number of encoder increments per revolution with 4-fold evaluation	UINT16	RW	0x1000 (4096 <sub>dec</sub> )
8010:09	Start velocity	Minimum starting velocity of the motor <b>Unit:</b> 10000 corresponds to 100%	UINT16	RW	0x0000 (0 <sub>dec</sub> )
8010:0A	Motor coil inductance	Inductance of the motor <b>Unit:</b> 0.01 mH	UINT16	RW	0x0000 (0 <sub>dec</sub> )
8010:10	Drive on delay time	Delay between activation of the driver stage and Ready = 1 <b>Unit:</b> 1 ms	UINT16	RW	0x0064 (100 <sub>dec</sub> )
8010:11	Drive off delay time	Delay between Ready = 0 and deactivation of the driver stage <b>Unit:</b> 1 ms	UINT16	RW	0x0096 (150 <sub>dec</sub> )

**Index 8011 STM Controller Settings Ch.1**

Index (hex)	Name	Meaning	Data type	Flags	Default
8011:0	STM Controller Settings Ch.1	Length of this object	UINT8	RO	0x02 (2 <sub>dec</sub> )
8011:01	Kp factor (curr.)	Kp control factor of the current controller	UINT16	RW	0x0096 (150 <sub>dec</sub> )
8011:02	Ki factor (curr.)	Ki control factor of the current controller	UINT16	RW	0x000A (10 <sub>dec</sub> )

## Index 8012 STM Features Ch.1

Index (hex)	Name	Meaning	Data type	Flags	Default
8012:0	STM Features Ch.1	Length of this object	UINT8	RO	0x3A (58 <sub>dec</sub> )
8012:01	Operation mode	Permitted values: 0: Automatic 1: Velocity direct 3: Position controller 4: Ext. Velocity mode 5: Ext. Position mode 6: Velocity sensorless	BIT4	RW	0x00 (0 <sub>dec</sub> )
8012:05	Speed range	Permitted values: 0: 1000 full steps / s 1: 2000 full steps / s 2: 4000 full steps / s 3: 8000 full steps / s 4: 16000 full steps / s 5: 32000 full steps / s	BIT3	RW	0x01 (1 <sub>dec</sub> )
8012:08	Feedback type	Permitted values: 0: Encoder 1: Internal counter	BIT1	RW	0x01 (1 <sub>dec</sub> )
8012:09	Invert motor polarity	Invert the direction of rotation of the motor	BOOLEAN	RW	0x00 (0 <sub>dec</sub> )
8012:0A	Error on step lost	Error on loss of step	BOOLEAN	RW	0x00 (0 <sub>dec</sub> )
8012:0B	Fan cartridge present	Fan cartridge present	BOOLEAN	RW	0x00 (0 <sub>dec</sub> )
8012:11	Select info data 1	Permitted values: 0: Status word 7: Motor velocity 11: Motor load 13: Motor dc current 101: Internal temperature 103: Control voltage 104: Motor supply voltage 150: Drive - Status word 151: Drive - State 152: Drive - Position lag (low word) 153: Drive - Position lag (high word)	UINT8	RW	0x0B (11 <sub>dec</sub> )
8012:19	Select info data 2	Permitted values: 0: Status word 7: Motor velocity 11: Motor load 13: Motor dc current 101: Internal temperature 103: Control voltage 104: Motor supply voltage 150: Drive - Status word 151: Drive - State 152: Drive - Position lag (low word) 153: Drive - Position lag (high word)	UINT8	RW	0x0D (13 <sub>dec</sub> )
8012:30	Invert digital input 1	Invert digital input	BOOLEAN	RW	0x00 (0 <sub>dec</sub> )
8012:31	Invert digital input 2	Invert digital input	BOOLEAN	RW	0x00 (0 <sub>dec</sub> )
8012:32	Function for input 1	Permitted values: 0: Normal input 1: Hardware enable 2: PLC cam 3: Auto start	BIT4	RW	0x00 (0 <sub>dec</sub> )
8012:36	Function for input 2	Permitted values: 0: Normal input 1: Hardware enable 2: PLC cam 3: Auto start	BIT4	RW	0x00 (0 <sub>dec</sub> )
8012:3A	Function for output 1	Permitted values: 0: Normal output 1: Break (linked with driver enable) 15: Disabled	BIT4	RW	0x0F (15 <sub>dec</sub> )



**Index 8014 STM Controller Settings 3 Ch.1**

Index (hex)	Name	Meaning	Data type	Flags	Default
8014:0	STM Controller Settings 3 Ch.1	Length of this object	UINT8	RO	0x09 (9 <sub>dec</sub> )
8014:01	Feed forward (pos.)	Pilot control of the position controller	UINT32	RW	0x000186A0 (10000 <sub>dec</sub> )
8014:02	Kp factor (pos.)	Kp control factor of the position controller	UINT16	RW	0x01F4 (500 <sub>dec</sub> )
8014:03	Kp factor (velo.)	Kp control factor of the velocity controller <b>Unit:</b> 0.01 ms	UINT32	RW	0x00000032 (50 <sub>dec</sub> )
8014:04	Tn (velo.)	Time constant Tn of the velocity controller <b>Unit:</b> 0.1 mA/(rad/s)	UINT16	RW	0xC350 (50000 <sub>dec</sub> )
8014:05	Sensorless param 1	First parameter (sensorless control)	UINT16	RW	0x0000 (0 <sub>dec</sub> )
8014:06	Sensorless param 2	Second parameter (sensorless control)	UINT16	RW	0x0000 (0 <sub>dec</sub> )
8014:07	Cross over velocity 1	First velocity transition (sensorless control) <b>Unit:</b> 0.1 rad/s	UINT16	RW	0x0000 (0 <sub>dec</sub> )
8014:08	Cross over velocity 2	Second velocity transition (sensorless control) <b>Unit:</b> 0.1 rad/s	UINT16	RW	0x0000 (0 <sub>dec</sub> )
8014:09	Cross over velocity 3	Third velocity transition (sensorless control) <b>Unit:</b> 0.1 rad/s	UINT16	RW	0x0000 (0 <sub>dec</sub> )

**Index 8020 POS Settings Ch.1**

Index (hex)	Name	Meaning	Data type	Flags	Default
8020:0	POS Settings Ch.1	Length of this object	UINT8	RO	0x11 (17 <sub>dec</sub> )
8020:01	Velocity min.	Minimum set velocity (range: 0-10000)	INT16	RW	0x0064 (100 <sub>dec</sub> )
8020:02	Velocity max.	Maximum set velocity (range: 0-10000)	INT16	RW	0x2710 (10000 <sub>dec</sub> )
8020:03	Acceleration pos.	Acceleration time in positive direction of rotation <b>Unit:</b> 1 ms	UINT16	RW	0x03E8 (1000 <sub>dec</sub> )
8020:04	Acceleration neg.	Acceleration time in negative direction of rotation <b>Unit:</b> 1 ms	UINT16	RW	0x03E8 (1000 <sub>dec</sub> )
8020:05	Deceleration pos.	Deceleration time in positive direction of rotation <b>Unit:</b> 1 ms	UINT16	RW	0x03E8 (1000 <sub>dec</sub> )
8020:06	Deceleration neg.	Deceleration time in negative direction of rotation <b>Unit:</b> 1 ms	UINT16	RW	0x03E8 (1000 <sub>dec</sub> )
8020:07	Emergency deceleration	Emergency deceleration time (both directions of rotation) <b>Unit:</b> 1 ms	UINT16	RW	0x0064 (100 <sub>dec</sub> )
8020:08	Calibration position	Calibration position	UINT32	RW	0x00000000 (0 <sub>dec</sub> )
8020:09	Calibration velocity (towards plc cam)	Calibration velocity towards the cam (range: 0-10000)	INT16	RW	0x0064 (100 <sub>dec</sub> )
8020:0A	Calibration velocity (off plc cam)	Calibration velocity away from the cam (range: 0-10000)	INT16	RW	0x000A (10 <sub>dec</sub> )
8020:0B	Target window	Target window	UINT16	RW	0x000A (10 <sub>dec</sub> )
8020:0C	In-Target timeout	Target position timeout <b>Unit:</b> 1 ms	UINT16	RW	0x03E8 (1000 <sub>dec</sub> )
8020:0D	Dead time compensation	Dead time compensation <b>Unit:</b> 1 µs	INT16	RW	0x0032 (50 <sub>dec</sub> )
8020:0E	Modulo factor	Modulo factor/position	UINT32	RW	0x00000000 (0 <sub>dec</sub> )
8020:0F	Modulo tolerance window	Tolerance window for modulo positioning	UINT32	RW	0x00000000 (0 <sub>dec</sub> )
8020:10	Position lag max.	Maximum allowable step error	UINT16	RW	0x0000 (0 <sub>dec</sub> )

## Index 8021 POS Features Ch.1

Index (hex)	Name	Meaning	Data type	Flags	Default
8021:0	POS Features Ch.1	Length of this object	UINT8	RO	0x16 (22 <sub>dec</sub> )
8021:01	Start type	permitted values: 0: Idle 1: Absolute 2: Relative 3: Endless plus 4: Endless minus 6: Additive 24832: Calibration (Hardware sync) 2457: Calibration (Plc cam) 28416: Calibration (Clear manual) 28160: Calibration (Set manual) 28161: Calibration (Set manual auto) 1029: Modulo current 773: Modulo minus 517: Modulo plus 261: Modulo short	UINT16	RW	0x0001 (1 <sub>dec</sub> )
8021:11	Time information	permitted values: 0: Elapsed time current drive time since start of the motion command	BIT2	RW	0x00 (0 <sub>dec</sub> )
8021:13	Invert calibration cam search direction	Inversion of the direction of rotation towards the cam	BOOLEAN	RW	0x01 (1 <sub>dec</sub> )
8021:14	Invert sync impulse search direction	Inversion of the direction of rotation away from the cam	BOOLEAN	RW	0x00 (0 <sub>dec</sub> )
8021:15	Emergency stop on position lag error	Triggers an emergency stop if the maximum following error is exceeded	BOOLEAN	RW	0x00 (0 <sub>dec</sub> )
8021:16	Enhanced diag history	Provides detailed messages about the status of the positioning interface in the diag history	BOOLEAN	RW	0x00 (0 <sub>dec</sub> )

## 8.2.3 Vendor configuration data (device-specific)

## Index F80F STM Vendor data

Index (hex)	Name	Meaning	Data type	Flags	Default
F80F:0	STM Vendor data	General information for the modular device profile	UINT8	RO	0x05 (5 <sub>dec</sub> )
F80F:04	Warning temperature	Temperature warning threshold Unit: 1°C	INT8	RW	0x50 (80 <sub>dec</sub> )
F80F:05	Switch off temperature	Switch-off temperature Unit: 1°C	INT8	RW	0x64 (100 <sub>dec</sub> )

## 8.2.4 Command object

## Index FB00 STM Command

Index (hex)	Name	Meaning	Data type	Flags	Default
FB00:0	STM Command	General information for the modular device profile	UINT8	RO	0x03 (3 <sub>dec</sub> )
FB00:01	Request	Requesting a command 0x8000: Software reset	OCTET-STRING[2]	RW	{0}
FB00:02	Status	Status of the command: 0: no error, without return value 1: no error, with return value 2: with error, no return value 3: with error, with return value .... reserved 255: Command execution active	UINT8	RO	0x00 (0 <sub>dec</sub> )
FB00:03	Response	Return value of the executed command	OCTET STRING[4]	RO	{0}

## 8.2.5 Input data

### Index 6000 ENC Inputs Ch.1

Index (hex)	Name	Meaning	Data type	Flags	Default
6000:0	ENC Inputs Ch.1	Length of this object	UINT8	RO	0x16 (22 <sub>dec</sub> )
6000:01	Latch C valid	The counter value was interlocked with the C-track.	BOOLEAN	RO	0x00 (0 <sub>dec</sub> )
6000:02	Latch extern valid	The counter value was stored via the external latch.	BOOLEAN	RO	0x00 (0 <sub>dec</sub> )
6000:03	Set counter done	The counter was set.	BOOLEAN	RO	0x00 (0 <sub>dec</sub> )
6000:04	Counter underflow	Counter underflow.	BOOLEAN	RO	0x00 (0 <sub>dec</sub> )
6000:05	Counter overflow	Counter overflow.	BOOLEAN	RO	0x00 (0 <sub>dec</sub> )
6000:08	Extrapolation stall	The extrapolated part of the counter is invalid	BOOLEAN	RO	0x00 (0 <sub>dec</sub> )
6000:09	Status of input A	Status of the A-input	BOOLEAN	RO	0x00 (0 <sub>dec</sub> )
6000:0A	Status of input B	Status of the B-input	BOOLEAN	RO	0x00 (0 <sub>dec</sub> )
6000:0B	Status of input C	Status of the C-input	BOOLEAN	RO	0x00 (0 <sub>dec</sub> )
6000:0D	Status of extern latch	The status of the external latch input	BOOLEAN	RO	0x00 (0 <sub>dec</sub> )
6000:0E	Sync error	The Sync error bit is only required for DC mode. It indicates whether a synchronization error has occurred during the previous cycle.	BOOLEAN	RO	0x00 (0 <sub>dec</sub> )
6000:10	TxPDO Toggle	The TxPDO toggle is toggled by the slave when the data of the associated TxPDO is updated.	BOOLEAN	RO	0x00 (0 <sub>dec</sub> )
6000:11	Counter value	The counter value	UINT32	RO	0x00000000 (0 <sub>dec</sub> )
6000:12	Latch value	The latch value	UINT32	RO	0x00000000 (0 <sub>dec</sub> )
6000:16	Timestamp	Timestamp of the last counter change	UINT32	RO	0x00000000 (0 <sub>dec</sub> )

### Index 6010 STM Inputs Ch. 1

Index (hex)	Name	Meaning	Data type	Flags	Default
6010:0	STM Inputs Ch. 1	Length of this object	UINT8	RO	0x15 (21 <sub>dec</sub> )
6010:01	Ready to enable	Driver stage is ready for enabling	BOOLEAN	RO	0x00 (0 <sub>dec</sub> )
6010:02	Ready	Driver stage is ready for operation	BOOLEAN	RO	0x00 (0 <sub>dec</sub> )
6010:03	Warning	a warning has occurred (see Index 0xA010 [► 78]) was activated.	BOOLEAN	RO	0x00 (0 <sub>dec</sub> )
6010:04	Error	an error has occurred (see Index 0xA010 [► 78]) was activated.	BOOLEAN	RO	0x00 (0 <sub>dec</sub> )
6010:05	Moving positive	Driver stage is activated in positive direction	BOOLEAN	RO	0x00 (0 <sub>dec</sub> )
6010:06	Moving negative	Driver stage is activated in negative direction	BOOLEAN	RO	0x00 (0 <sub>dec</sub> )
6010:07	Torque reduced	Reduced torque is active	BOOLEAN	RO	0x00 (0 <sub>dec</sub> )
6010:08	Motor stall	A loss of step has occurred	BOOLEAN	RO	0x00 (0 <sub>dec</sub> )
6010:0C	Digital input 1	Digital input 1	BOOLEAN	RO	0x00 (0 <sub>dec</sub> )
6010:0D	Digital input 2	Digital input 2	BOOLEAN	RO	0x00 (0 <sub>dec</sub> )
6010:0E	Sync error	The Sync error bit is only required for DC mode. It indicates whether a synchronization error has occurred during the previous cycle.	BOOLEAN	RO	0x00 (0 <sub>dec</sub> )
6010:10	TxPDO Toggle	The TxPDO toggle is toggled by the slave when the data of the associated TxPDO is updated	BOOLEAN	RO	0x00 (0 <sub>dec</sub> )
6010:11	Info data 1	Synchronous information (selection via subindex 0x8012:11 [► 70])	UINT16	RO	0x0000 (0 <sub>dec</sub> )
6010:12	Info data 2	Synchronous information (selection via subindex 0x8012:19 [► 70])	UINT16	RO	0x0000 (0 <sub>dec</sub> )
6010:13	Motor load	Current motor load <b>Unit:</b> 0.01°	INT16	RO	0x0000 (0 <sub>dec</sub> )
6010:14	Internal position	Internal microstep position	UINT32	RO	0x00000000 (0 <sub>dec</sub> )
6010:15	External position	Encoder position	UINT32	RO	0x00000000 (0 <sub>dec</sub> )

## Index 6020 POS Inputs Ch. 1

Index (hex)	Name	Meaning	Data type	Flags	Default
6020:0	POS Inputs Ch. 1	Length of this object	UINT8	RO	0x23 (35 <sub>dec</sub> )
6020:01	Busy	A current motion command is active	BOOLEAN	RO	0x00 (0 <sub>dec</sub> )
6020:02	In-Target	Motor has arrived at target	BOOLEAN	RO	0x00 (0 <sub>dec</sub> )
6020:03	Warning	A warning has occurred	BOOLEAN	RO	0x00 (0 <sub>dec</sub> )
6020:04	Error	An error has occurred	BOOLEAN	RO	0x00 (0 <sub>dec</sub> )
6020:05	Calibrated	Motor is calibrated	BOOLEAN	RO	0x00 (0 <sub>dec</sub> )
6020:06	Accelerate	Motor is in the acceleration phase	BOOLEAN	RO	0x00 (0 <sub>dec</sub> )
6020:07	Decelerate	Motor is in the deceleration phase	BOOLEAN	RO	0x00 (0 <sub>dec</sub> )
6020:08	Ready to execute	ready for motion command	BOOLEAN	RO	0x00 (0 <sub>dec</sub> )
6020:11	Actual position	Current set position of the motion command generator	UINT32	RO	0x00000000 (0 <sub>dec</sub> )
6020:21	Actual velocity	Current set velocity of the motion command generator	INT16	RO	0x0000 (0 <sub>dec</sub> )
6020:22	Actual drive time	Motion command time information (see subindex 0x8021:11 <a href="#">▶ 721</a> )	UINT32	RO	0x00000000 (0 <sub>dec</sub> )
6020:23	Actual position lag	Following error	INT32	RO	0x00000000 (0 <sub>dec</sub> )

## 8.2.6 Output data

## Index 7000 ENC Outputs Ch. 1

Index (hex)	Name	Meaning	Data type	Flags	Default
7000:0	ENC Outputs Ch. 1	Maximum subindex	UINT8	RO	0x11 (17 <sub>dec</sub> )
7000:01	Enable latch C	Activate saving via input "C".	BOOLEAN	RO	0x00 (0 <sub>dec</sub> )
7000:02	Enable latch extern on positive edge	Activate external latch with positive edge.	BOOLEAN	RO	0x00 (0 <sub>dec</sub> )
7000:03	Set counter	Set counter value	BOOLEAN	RO	0x00 (0 <sub>dec</sub> )
7000:04	Enable latch extern on negative edge	Activate external latch with negative edge.	BOOLEAN	RO	0x00 (0 <sub>dec</sub> )
7000:11	Set counter value	The counter value to be set via "Set counter" (Index 0x7000:03).	UINT32	RO	0x00000000 (0 <sub>dec</sub> )

## Index 7010 STM Outputs Ch. 1

Index (hex)	Name	Meaning	Data type	Flags	Default
7010:0	STM Outputs Ch. 1	Maximum subindex	UINT8	RO	0x21 (33 <sub>dec</sub> )
7010:01	Enable	activates the output stage	BOOLEAN	RO	0x00 (0 <sub>dec</sub> )
7010:02	Reset	all errors that may have occurred are reset by setting this bit (rising edge)	BOOLEAN	RO	0x00 (0 <sub>dec</sub> )
7010:03	Reduce torque	Reduced torque (coil current) is active (see Subindex 0x8010:02 <a href="#">▶ 681</a> )	BOOLEAN	RO	0x00 (0 <sub>dec</sub> )
7010:0C	Digital output 1	Digital output 1	BOOLEAN	RO	0x00 (0 <sub>dec</sub> )
7010:11	Position	Set position specification <b>Unit:</b> Increments	UINT32	RO	0x00000000 (0 <sub>dec</sub> )
7010:21	Velocity	Set velocity specification <b>Unit:</b> $\pm 32767$ corresponds to $\pm 100\%$	INT16	RO	0x0000 (0 <sub>dec</sub> )

**Index 7020 POS Outputs Ch. 1**

Index (hex)	Name	Meaning	Data type	Flags	Default																																												
7020:0	POS Outputs Ch. 1	Maximum subindex	UINT8	RO	0x24 (36 <sub>dec</sub> )																																												
7020:01	Execute	Start motion command (rising edge), or prematurely abort motion command (falling edge)	BOOLEAN	RO	0x00 (0 <sub>dec</sub> )																																												
7020:02	Emergency Stop	Prematurely abort motion command with an emergency ramp (rising edge)	BOOLEAN	RO	0x00 (0 <sub>dec</sub> )																																												
7020:11	Target position	Specification of the target position	UINT32	RO	0x00000000 (0 <sub>dec</sub> )																																												
7020:21	Velocity	Specification of the maximum step velocity	INT16	RO	0x0000 (0 <sub>dec</sub> )																																												
7020:22	Start type	<table border="1"> <tr> <td>0x0000 Idle</td> <td>No motion command is being executed</td> </tr> <tr> <td>0x0001 Absolute</td> <td>Absolute target position</td> </tr> <tr> <td>0x1001 Absolute (change)</td> <td>Change during an active motion command</td> </tr> <tr> <td>0x0002 Relative</td> <td>Target position relative to the current position</td> </tr> <tr> <td>0x1002 Relative (change)</td> <td>Change during an active motion command</td> </tr> <tr> <td>0x0003 Endless plus</td> <td>Endless driving in positive direction of rotation</td> </tr> <tr> <td>0x0004 Endless minus</td> <td>Endless driving in negative direction of rotation</td> </tr> <tr> <td>0x0105 Modulo short</td> <td>Shortest distance to the next modulo position</td> </tr> <tr> <td>0x0115 Modulo short extended</td> <td>Shortest distance to the next modulo position (without modulo window)</td> </tr> <tr> <td>0x0205 Modulo plus</td> <td>Drive in positive direction of rotation to the next modulo position</td> </tr> <tr> <td>0x0215 Modulo plus extended</td> <td>Drive in positive direction of rotation to the next modulo position (without modulo window)</td> </tr> <tr> <td>0x0305 Modulo minus</td> <td>Drive in negative direction of rotation to the next modulo position</td> </tr> <tr> <td>0x0315 Modulo minus extended</td> <td>Drive in negative direction of rotation to the next modulo position (without modulo window)</td> </tr> <tr> <td>0x0405 Modulo current</td> <td>Drive in the last implemented direction of rotation to the next modulo position</td> </tr> <tr> <td>0x0415 Modulo current extended</td> <td>Drive in the last implemented direction of rotation to the next modulo position (without modulo window)</td> </tr> <tr> <td>0x0006 Additive</td> <td>New target position relative/additive to the last target position</td> </tr> <tr> <td>0x1006 Additive (change)</td> <td>Change during an active motion command</td> </tr> <tr> <td>0x6000 Calibration, PLC cam</td> <td>Calibration with cam</td> </tr> <tr> <td>0x6100 Calibration, HW sync</td> <td>Calibration with cam and C-track</td> </tr> <tr> <td>0x6E00 Calibration, set manual</td> <td>Set calibration manually</td> </tr> <tr> <td>0x6E01 Calibration, set manual auto</td> <td>Set calibration automatically, with "Enable=1"</td> </tr> <tr> <td>0x6F00 Calibration, clear manual</td> <td>Clear calibration manually</td> </tr> </table>	0x0000 Idle	No motion command is being executed	0x0001 Absolute	Absolute target position	0x1001 Absolute (change)	Change during an active motion command	0x0002 Relative	Target position relative to the current position	0x1002 Relative (change)	Change during an active motion command	0x0003 Endless plus	Endless driving in positive direction of rotation	0x0004 Endless minus	Endless driving in negative direction of rotation	0x0105 Modulo short	Shortest distance to the next modulo position	0x0115 Modulo short extended	Shortest distance to the next modulo position (without modulo window)	0x0205 Modulo plus	Drive in positive direction of rotation to the next modulo position	0x0215 Modulo plus extended	Drive in positive direction of rotation to the next modulo position (without modulo window)	0x0305 Modulo minus	Drive in negative direction of rotation to the next modulo position	0x0315 Modulo minus extended	Drive in negative direction of rotation to the next modulo position (without modulo window)	0x0405 Modulo current	Drive in the last implemented direction of rotation to the next modulo position	0x0415 Modulo current extended	Drive in the last implemented direction of rotation to the next modulo position (without modulo window)	0x0006 Additive	New target position relative/additive to the last target position	0x1006 Additive (change)	Change during an active motion command	0x6000 Calibration, PLC cam	Calibration with cam	0x6100 Calibration, HW sync	Calibration with cam and C-track	0x6E00 Calibration, set manual	Set calibration manually	0x6E01 Calibration, set manual auto	Set calibration automatically, with "Enable=1"	0x6F00 Calibration, clear manual	Clear calibration manually	UINT16	RO	0x0000 (0 <sub>dec</sub> )
0x0000 Idle	No motion command is being executed																																																
0x0001 Absolute	Absolute target position																																																
0x1001 Absolute (change)	Change during an active motion command																																																
0x0002 Relative	Target position relative to the current position																																																
0x1002 Relative (change)	Change during an active motion command																																																
0x0003 Endless plus	Endless driving in positive direction of rotation																																																
0x0004 Endless minus	Endless driving in negative direction of rotation																																																
0x0105 Modulo short	Shortest distance to the next modulo position																																																
0x0115 Modulo short extended	Shortest distance to the next modulo position (without modulo window)																																																
0x0205 Modulo plus	Drive in positive direction of rotation to the next modulo position																																																
0x0215 Modulo plus extended	Drive in positive direction of rotation to the next modulo position (without modulo window)																																																
0x0305 Modulo minus	Drive in negative direction of rotation to the next modulo position																																																
0x0315 Modulo minus extended	Drive in negative direction of rotation to the next modulo position (without modulo window)																																																
0x0405 Modulo current	Drive in the last implemented direction of rotation to the next modulo position																																																
0x0415 Modulo current extended	Drive in the last implemented direction of rotation to the next modulo position (without modulo window)																																																
0x0006 Additive	New target position relative/additive to the last target position																																																
0x1006 Additive (change)	Change during an active motion command																																																
0x6000 Calibration, PLC cam	Calibration with cam																																																
0x6100 Calibration, HW sync	Calibration with cam and C-track																																																
0x6E00 Calibration, set manual	Set calibration manually																																																
0x6E01 Calibration, set manual auto	Set calibration automatically, with "Enable=1"																																																
0x6F00 Calibration, clear manual	Clear calibration manually																																																
7020:23	Acceleration	Acceleration specification	UINT16	RO	0x0000 (0 <sub>dec</sub> )																																												
7020:24	Deceleration	Deceleration specification	UINT16	RO	0x0000 (0 <sub>dec</sub> )																																												

## Index 7021 POS Outputs 2 Ch. 1

Index (hex)	Name	Meaning	Data type	Flags	Default																																																																		
7021:0	POS Outputs 2 Ch. 1	Maximum subindex	UINT8	RO	0x24 (36 <sub>dec</sub> )																																																																		
7021:03	Enable auto start	Enable auto-start function	BOOLEAN	RO	0x00 (0 <sub>dec</sub> )																																																																		
7021:11	Target position	Specification of the target position	UINT32	RO	0x00000000 (0 <sub>dec</sub> )																																																																		
7021:21	Velocity	Specification of the maximum set velocity	INT16	RO	0x0000 (0 <sub>dec</sub> )																																																																		
7021:22	Start type	<table border="1"> <tbody> <tr> <td>0x0000</td> <td>Idle</td> <td>No motion command is being executed</td> </tr> <tr> <td>0x0001</td> <td>Absolute</td> <td>Absolute target position</td> </tr> <tr> <td>0x1001</td> <td>Absolute (change)</td> <td>Change during an active motion command</td> </tr> <tr> <td>0x0002</td> <td>Relative</td> <td>Target position relative to the current position</td> </tr> <tr> <td>0x1002</td> <td>Relative (change)</td> <td>Change during an active motion command</td> </tr> <tr> <td>0x0003</td> <td>Endless plus</td> <td>Endless driving in positive direction of rotation</td> </tr> <tr> <td>0x0004</td> <td>Endless minus</td> <td>Endless driving in negative direction of rotation</td> </tr> <tr> <td>0x0105</td> <td>Modulo short</td> <td>Shortest distance to the next modulo position</td> </tr> <tr> <td>0x0115</td> <td>Modulo short extended</td> <td>Shortest distance to the next modulo position (without modulo window)</td> </tr> <tr> <td>0x0205</td> <td>Modulo plus</td> <td>Drive in positive direction of rotation to the next modulo position</td> </tr> <tr> <td>0x0215</td> <td>Modulo plus extended</td> <td>Drive in positive direction of rotation to the next modulo position (without modulo window)</td> </tr> <tr> <td>0x0305</td> <td>Modulo minus</td> <td>Drive in negative direction of rotation to the next modulo position</td> </tr> <tr> <td>0x0315</td> <td>Modulo minus extended</td> <td>Drive in negative direction of rotation to the next modulo position (without modulo window)</td> </tr> <tr> <td>0x0405</td> <td>Modulo current</td> <td>Drive in the last implemented direction of rotation to the next modulo position</td> </tr> <tr> <td>0x0415</td> <td>Modulo current extended</td> <td>Drive in the last implemented direction of rotation to the next modulo position (without modulo window)</td> </tr> <tr> <td>0x0006</td> <td>Additive</td> <td>New target position relative/additive to the last target position</td> </tr> <tr> <td>0x1006</td> <td>Additive (change)</td> <td>Change during an active motion command</td> </tr> <tr> <td>0x6000</td> <td>Calibration, PLC cam</td> <td>Calibration with cam</td> </tr> <tr> <td>0x6100</td> <td>Calibration, HW sync</td> <td>Calibration with cam and C-track</td> </tr> <tr> <td>0x6E00</td> <td>Calibration, set manual</td> <td>Set calibration manually</td> </tr> <tr> <td>0x6E01</td> <td>Calibration, set manual auto</td> <td>Set calibration automatically, with "Enable=1"</td> </tr> <tr> <td>0x6F00</td> <td>Calibration, clear manual</td> <td>Clear calibration manually</td> </tr> </tbody> </table>	0x0000	Idle	No motion command is being executed	0x0001	Absolute	Absolute target position	0x1001	Absolute (change)	Change during an active motion command	0x0002	Relative	Target position relative to the current position	0x1002	Relative (change)	Change during an active motion command	0x0003	Endless plus	Endless driving in positive direction of rotation	0x0004	Endless minus	Endless driving in negative direction of rotation	0x0105	Modulo short	Shortest distance to the next modulo position	0x0115	Modulo short extended	Shortest distance to the next modulo position (without modulo window)	0x0205	Modulo plus	Drive in positive direction of rotation to the next modulo position	0x0215	Modulo plus extended	Drive in positive direction of rotation to the next modulo position (without modulo window)	0x0305	Modulo minus	Drive in negative direction of rotation to the next modulo position	0x0315	Modulo minus extended	Drive in negative direction of rotation to the next modulo position (without modulo window)	0x0405	Modulo current	Drive in the last implemented direction of rotation to the next modulo position	0x0415	Modulo current extended	Drive in the last implemented direction of rotation to the next modulo position (without modulo window)	0x0006	Additive	New target position relative/additive to the last target position	0x1006	Additive (change)	Change during an active motion command	0x6000	Calibration, PLC cam	Calibration with cam	0x6100	Calibration, HW sync	Calibration with cam and C-track	0x6E00	Calibration, set manual	Set calibration manually	0x6E01	Calibration, set manual auto	Set calibration automatically, with "Enable=1"	0x6F00	Calibration, clear manual	Clear calibration manually	UINT16	RO	0x0000 (0 <sub>dec</sub> )
0x0000	Idle	No motion command is being executed																																																																					
0x0001	Absolute	Absolute target position																																																																					
0x1001	Absolute (change)	Change during an active motion command																																																																					
0x0002	Relative	Target position relative to the current position																																																																					
0x1002	Relative (change)	Change during an active motion command																																																																					
0x0003	Endless plus	Endless driving in positive direction of rotation																																																																					
0x0004	Endless minus	Endless driving in negative direction of rotation																																																																					
0x0105	Modulo short	Shortest distance to the next modulo position																																																																					
0x0115	Modulo short extended	Shortest distance to the next modulo position (without modulo window)																																																																					
0x0205	Modulo plus	Drive in positive direction of rotation to the next modulo position																																																																					
0x0215	Modulo plus extended	Drive in positive direction of rotation to the next modulo position (without modulo window)																																																																					
0x0305	Modulo minus	Drive in negative direction of rotation to the next modulo position																																																																					
0x0315	Modulo minus extended	Drive in negative direction of rotation to the next modulo position (without modulo window)																																																																					
0x0405	Modulo current	Drive in the last implemented direction of rotation to the next modulo position																																																																					
0x0415	Modulo current extended	Drive in the last implemented direction of rotation to the next modulo position (without modulo window)																																																																					
0x0006	Additive	New target position relative/additive to the last target position																																																																					
0x1006	Additive (change)	Change during an active motion command																																																																					
0x6000	Calibration, PLC cam	Calibration with cam																																																																					
0x6100	Calibration, HW sync	Calibration with cam and C-track																																																																					
0x6E00	Calibration, set manual	Set calibration manually																																																																					
0x6E01	Calibration, set manual auto	Set calibration automatically, with "Enable=1"																																																																					
0x6F00	Calibration, clear manual	Clear calibration manually																																																																					
7021:23	Acceleration	Acceleration specification	UINT16	RO	0x0000 (0 <sub>dec</sub> )																																																																		
7021:24	Deceleration	Deceleration specification	UINT16	RO	0x0000 (0 <sub>dec</sub> )																																																																		

## 8.2.7 Information and diagnostic data

Channel-specific:

### Index 9010 STM Info data Ch.1

Index (hex)	Name	Meaning	Data type	Flags	Default
9010:0	STM Info data Ch.1	General information for the modular device profile	UINT8	RO	0x13 (19 <sub>dec</sub> )
9010:01	Status word	Status word (see index 0xA010 [► 78])	UINT16	RO	0x0000 (0 <sub>dec</sub> )
9010:08	Motor velocity	Current motor velocity	INT16	RO	0x0000 (0 <sub>dec</sub> )
9010:09	Internal position	Internal position (micro increments)	UINT32	RO	0x00000000 (0 <sub>dec</sub> )
9010:0B	Motor load	Current motor load <b>Unit:</b> 0.01°	INT16	RO	0x0000 (0 <sub>dec</sub> )
9010:0D	Motor dc current	Current motor current (DC vector) <b>Unit:</b> 1 mA	INT16	RO	0x0000 (0 <sub>dec</sub> )
9010:0E	Tn (curr.)	Internally calculated time constant of the current controller <b>Unit:</b> 0.01 ms	UINT16	RO	0x0000 (0 <sub>dec</sub> )
9010:13	External position	external position (connected encoder)	UINT32	RO	0x00000000 (0 <sub>dec</sub> )

### Index 9020 POS Info data Ch.1

Index (hex)	Name	Meaning	Data type	Flags	Default
9020:0	POS Info data Ch.1	General information for the modular device profile	UINT8	RO	0x04 (4 <sub>dec</sub> )
9020:01	Status word	Status word	UINT16	RO	0x0000 (0 <sub>dec</sub> )
9020:03	State (drive controller)	permitted values: 0: Init 1: Idle 16: Start 17: Acceleration 18: Constant 19: Deceleration 32: Emergency stop 33: Normal stop 256: Calibration start 272: Go cam 273: On cam 288: Go sync impulse 289: Leave cam 304: Calibration stop 320: Is calibrated 321: Not calibrated 4096: Pre target 4097: In target 8192: Drive end 8192: Wait for init 16384: Drive warning 32768: Error 65535: Undefined	UINT16	RO	0x0000 (0 <sub>dec</sub> )
9020:04	Actual position lag	Current step error	INT32	RO	0x00000000 (0 <sub>dec</sub> )

## Index A010 STM Diag data Ch.1

Index (hex)	Name	Meaning	Data type	Flags	Default
A010:0	STM Diag data Ch.1	General information for the modular device profile	UINT8	RO	0x11 (17 <sub>dec</sub> )
A010:01	Saturated	Driver stage operates with maximum duty cycle	BOOLEAN	RO	0x00 (0 <sub>dec</sub> )
A010:02	Over temperature	Internal temperature of the module is higher than 80°C	BOOLEAN	RO	0x00 (0 <sub>dec</sub> )
A010:03	Torque overload	Duty cycle output at 100%	BOOLEAN	RO	0x00 (0 <sub>dec</sub> )
A010:04	Under voltage	Supply voltage is lower than 7 V	BOOLEAN	RO	0x00 (0 <sub>dec</sub> )
A010:05	Over voltage	Supply voltage is 10% higher than the rated voltage (see Index 0x8010:03 ▶ 68)	BOOLEAN	RO	0x00 (0 <sub>dec</sub> )
A010:06	Short circuit	Short circuit of motor coil	BOOLEAN	RO	0x00 (0 <sub>dec</sub> )
A010:08	No control power	No power supply to driver stage	BOOLEAN	RO	0x00 (0 <sub>dec</sub> )
A010:09	Misc error	<ul style="list-style-type: none"> <li>Initialization failed or</li> <li>Internal temperature of the module is higher than 100°C (see Index 0xF80F:05)</li> </ul>	BOOLEAN	RO	0x00 (0 <sub>dec</sub> )
A010:0A	Configuration	CoE change has not yet been adopted into the current configuration	BOOLEAN	RO	0x00 (0 <sub>dec</sub> )
A010:0B	Motor stall	A loss of step has occurred	BOOLEAN	RO	0x00 (0 <sub>dec</sub> )
A010:0C	Open load A		BOOLEAN	RO	0x00 (0 <sub>dec</sub> )
A010:0D	Open load B		BOOLEAN	RO	0x00 (0 <sub>dec</sub> )
A010:11	Actual operation mode	permitted values: 0: Automatic 1: Velocity direct 2: Velocity controller 3: Position controller 4: Ext. Velocity mode 5: Ext. Position mode 6: Velocity sensorless	BOOLEAN	RO	0x00 (0 <sub>dec</sub> )

## Index A020 POS Diag data Ch.1

Index (hex)	Name	Meaning	Data type	Flags	Default
A020:0	POS Diag data Ch.1	General information for the modular device profile	UINT8	RO	0x06 (6 <sub>dec</sub> )
A020:01	Command rejected	Motion command was rejected	BOOLEAN	RO	0x00 (0 <sub>dec</sub> )
A020:02	Command aborted	Motion command was aborted	BOOLEAN	RO	0x00 (0 <sub>dec</sub> )
A020:03	Target overrun	Target window was overshoot in the opposite direction.	BOOLEAN	RO	0x00 (0 <sub>dec</sub> )
A020:04	Target timeout	The target window was not reached within the In-Target timeout.	BOOLEAN	RO	0x00 (0 <sub>dec</sub> )
A020:05	Position lag	The maximum following error was exceeded.	BOOLEAN	RO	0x00 (0 <sub>dec</sub> )
A020:06	Emergency Stop	An emergency stop was triggered (automatic or manual)	BOOLEAN	RO	0x00 (0 <sub>dec</sub> )

## Device-specific:

## Index F000 Modular device profile

Index (hex)	Name	Meaning	Data type	Flags	Default
F000:0	Modular device profile	General information for the modular device profile	UINT8	RO	0x02 (2 <sub>dec</sub> )
F000:01	Module index distance	Index distance of the objects of the individual channels	UINT16	RO	0x0010 (16 <sub>dec</sub> )
F000:02	Maximum number of modules	Number of channels	UINT16	RO	0x0003 (3 <sub>dec</sub> )

## Index F008 Code word

Index (hex)	Name	Meaning	Data type	Flags	Default
F008:0	Code word	reserved	UINT32	RW	0x00000000 (0 <sub>dec</sub> )



**Index F010 Module list**

Index (hex)	Name	Meaning	Data type	Flags	Default
F010:0	Module list	Length of this object	UINT8	RW	0x03 (3 <sub>dec</sub> )
F010:01	SubIndex 001	-	UINT32	RW	0x000001FF (511 <sub>dec</sub> )
F010:02	SubIndex 002	-	UINT32	RW	0x000002BF (703 <sub>dec</sub> )
F010:03	SubIndex 003	-	UINT32	RW	0x000002C0 (704 <sub>dec</sub> )

**Index F081 Download revision**

Index (hex)	Name	Meaning	Data type	Flags	Default
F081:0	Download revision	General information for the modular device profile	UINT8	RO	0x01 (1 <sub>dec</sub> )
F081:01	Revision number	Revision number	UINT32	RW	0x00000000 (0 <sub>dec</sub> )

**Index F900 STM Info data**

Index (hex)	Name	Meaning	Data type	Flags	Default
F900:0	STM Info data	General information for the modular device profile	UINT8	RO	0x06 (6 <sub>dec</sub> )
F900:01	Software version (driver)	Software version of the output driver	STRING	RO	
F900:02	Internal temperature	Internal module temperature <b>Unit:</b> 1°C	INT8	RO	0x00 (0 <sub>dec</sub> )
F900:04	Control voltage	Control voltage <b>Unit:</b> 1 mV, 10 mV with field-oriented control	UINT16	RO	0x0000 (0 <sub>dec</sub> )
F900:05	Motor supply voltage	Motor supply voltage <b>Unit:</b> 1 mV, 10 mV with field-oriented control	UINT16	RO	0x0000 (0 <sub>dec</sub> )
F900:06	Cycle time	current cycle time <b>Unit:</b> 1 µs	UINT16	RO	0x0000 (0 <sub>dec</sub> )

**Index FB40 Memory interface**

Index (hex)	Name	Meaning	Data type	Flags	Default
FB40:0	Memory interface	General information for the modular device profile	UINT8	RO	0x03 (3 <sub>dec</sub> )
FB40:01	Address	reserved	UINT32	RW	0x00000000 (0 <sub>dec</sub> )
FB40:02	Length	reserved	UINT16	RW	0x0000 (0 <sub>dec</sub> )
FB40:03	Data	reserved	OCTET STRING[8]	RW	{0}

**8.2.8 Standard objects (0x1000-0x1FFF)**

The standard objects have the same meaning for all EtherCAT slaves.

**Index 1000 Device type**

Index (hex)	Name	Meaning	Data type	Flags	Default
1000:0	Device type	Device type of the EtherCAT slave: The Lo-Word contains the CoE profile used (5001). The Hi-Word contains the module profile according to the modular device profile.	UINT32	RO	0x00001389 (5001 <sub>dec</sub> )

**Index 1008 Device name**

Index (hex)	Name	Meaning	Data type	Flags	Default
1008:0	Device name	Device name of the EtherCAT slave	STRING	RO	EJ7047

**Index 1009 Hardware version**

Index (hex)	Name	Meaning	Data type	Flags	Default
1009:0	Hardware version	Hardware version of the EtherCAT slave	STRING	RO	00

**Index 100A Software version**

Index (hex)	Name	Meaning	Data type	Flags	Default
100A:0	Software version	Firmware version of the EtherCAT slave	STRING	RO	01

**Index 1018 Identity**

Index (hex)	Name	Meaning	Data type	Flags	Default
1018:0	Identity	Information for identifying the slave	UINT8	RO	0x04 (4 <sub>dec</sub> )
1018:01	Vendor ID	Vendor ID of the EtherCAT slave	UINT32	RO	0x00000002 (2 <sub>dec</sub> )
1018:02	Product code	Product code of the EtherCAT slave	UINT32	RO	0x1B872852 (461842514 <sub>dec</sub> )
1018:03	Revision	Revision number of the EtherCAT slave; the Low Word (bit 0-15) indicates the special terminal number, the High Word (bit 16-31) refers to the device description	UINT32	RO	0x00000000 (0 <sub>dec</sub> )
1018:04	Serial number	Serial number of the EtherCAT slave; the Low Byte (bit 0-7) of the Low Word contains the year of production, the High Byte (bit 8-15) of the Low Word contains the week of production, the High Word (bit 16-31) is 0	UINT32	RO	0x00000000 (0 <sub>dec</sub> )

**Index 10F0 Backup parameter handling**

Index (hex)	Name	Meaning	Data type	Flags	Default
10F0:0	Backup parameter handling	Information for standardized loading and saving of backup entries	UINT8	RO	0x01 (1 <sub>dec</sub> )
10F0:01	Checksum	Checksum across all backup entries of the EtherCAT slave	UINT32	RO	0x00000000 (0 <sub>dec</sub> )

**Index 10F3 Diagnosis History**

Index (hex)	Name	Meaning	Data type	Flags	Default
10F3:0	Diagnosis History	Max. Subindex	UINT8	RO	0x37 (55 <sub>dec</sub> )
10F3:01	Maximum Messages	Maximum number of stored messages. A maximum of 16 messages can be stored	UINT32	RO	0x00000000 (0 <sub>dec</sub> )
10F3:02	Newest Message	Subindex of the latest message	UINT8	RO	0x00 (0 <sub>dec</sub> )
10F3:03	Newest Acknowledged Message	Subindex of the last confirmed message	UINT8	RO	0x00 (0 <sub>dec</sub> )
10F3:04	New Message available	Indicates that a new message is available	BOOLEAN	RO	0x00 (0 <sub>dec</sub> )
10F3:05	Flags	not used	UINT16	RO	0x0000 (0 <sub>dec</sub> )
10F3:06	Diagnosis Message 001	Message 1	OCTET STRING[28]	RO	{0}
...	...	...	...	...	...
10F3:37	Diagnosis Message 050	Message 50	OCTET STRING[28]	RO	{0}

**Index 10F8 Actual Time Stamp**

Index (hex)	Name	Meaning	Data type	Flags	Default
10F8:0	Actual Time Stamp	Timestamp	UINT64	RO	

**Index 1400 ENC RxPDO-Par Control compact**

Index (hex)	Name	Meaning	Data type	Flags	Default
1400:0	ENC RxPDO-Par Control compact	PDO Parameter RxPDO 1	UINT8	RO	0x06 (6 <sub>dec</sub> )
1400:06	Exclude RxPDOs	Specifies the RxPDOs (index of RxPDO mapping objects) that must not be transferred together with RxPDO 1.	OCTET-STRING[6]	RO	01 16 00 00 00 00

**Index 1401 ENC RxPDO-Par Control**

Index (hex)	Name	Meaning	Data type	Flags	Default
1401:0	ENC RxPDO-Par Control	PDO Parameter RxPDO 2	UINT8	RO	0x06 (6 <sub>dec</sub> )
1401:06	Exclude RxPDOs	Specifies the RxPDOs (index of RxPDO mapping objects) that must not be transferred together with RxPDO 2.	OCTET-STRING[6]	RO	00 16 00 00 00 00

**Index 1403 STM RxPDO-Par Position**

Index (hex)	Name	Meaning	Data type	Flags	Default
1403:0	STM RxPDO-Par Position	PDO Parameter RxPDO 4	UINT8	RO	0x06 (6 <sub>dec</sub> )
1403:06	Exclude RxPDOs	Specifies the RxPDOs (index of RxPDO mapping objects) that must not be transferred together with RxPDO 4.	OCTET-STRING[6]	RO	04 16 05 16 06 16

**Index 1404 STM RxPDO-Par Velocity**

Index (hex)	Name	Meaning	Data type	Flags	Default
1404:0	STM RxPDO-Par Velocity	PDO Parameter RxPDO 5	UINT8	RO	0x06 (6 <sub>dec</sub> )
1404:06	Exclude RxPDOs	Specifies the RxPDOs (index of RxPDO mapping objects) that must not be transferred together with RxPDO 5.	OCTET-STRING[6]	RO	03 16 05 16 06 16

**Index 1405 POS RxPDO-Par Control compact**

Index (hex)	Name	Meaning	Data type	Flags	Default
1405:0	POS RxPDO-Par Control compact	PDO Parameter RxPDO 6	UINT8	RO	0x06 (6 <sub>dec</sub> )
1405:06	Exclude RxPDOs	Specifies the RxPDOs (index of RxPDO mapping objects) that must not be transferred together with RxPDO 6.	OCTET-STRING[6]	RO	03 16 04 16 06 16

**Index 1406 POS RxPDO-Par Control**

Index (hex)	Name	Meaning	Data type	Flags	Default
1406:0	POS RxPDO-Par Control	PDO Parameter RxPDO 7	UINT8	RO	0x06 (6 <sub>dec</sub> )
1406:06	Exclude RxPDOs	Specifies the RxPDOs (index of RxPDO mapping objects) that must not be transferred together with RxPDO 7.	OCTET-STRING[6]	RO	03 16 04 16 05 16

**Index 1407 POS RxPDO-Par Control 2**

Index (hex)	Name	Meaning	Data type	Flags	Default
1407:0	POS RxPDO-Par Control 2	PDO Parameter RxPDO 8	UINT8	RO	0x06 (6 <sub>dec</sub> )
1407:06	Exclude RxPDOs	Specifies the RxPDOs (index of RxPDO mapping objects) that must not be transferred together with RxPDO 8	OCTET-STRING[6]	RO	03 16 04 16 05 16

**Index 1600 ENC RxPDO-Map Control compact**

Index (hex)	Name	Meaning	Data type	Flags	Default
1600:0	ENC RxPDO-Map Control compact	PDO Mapping RxPDO 1	UINT8	RO	0x06 (6 <sub>dec</sub> )
1600:01	SubIndex 001	1. PDO Mapping entry (object 0x7000 (ENC Outputs Ch.1), entry 0x01 (Enable latch C))	UINT32	RO	0x7000:01, 1
1600:02	SubIndex 002	2. PDO Mapping entry (object 0x7000 (ENC Outputs Ch.1), entry 0x02 (Enable latch extern on positive edge))	UINT32	RO	0x7000:02, 1
1600:03	SubIndex 003	3. PDO Mapping entry (object 0x7000 (ENC Outputs Ch.1), entry 0x03 (Set counter))	UINT32	RO	0x7000:03, 1
1600:04	SubIndex 004	4. PDO Mapping entry (object 0x7000 (ENC Outputs Ch.1), entry 0x04 (Enable latch extern on negative edge))	UINT32	RO	0x7000:04, 1
1600:05	SubIndex 005	5. PDO Mapping entry (12 bits align)	UINT32	RO	0x0000:00, 12
1600:06	SubIndex 006	6. PDO Mapping entry (object 0x7000 (ENC Outputs Ch.1), entry 0x11 (Set counter value))	UINT32	RO	0x7000:11, 16

**Index 1601 ENC RxPDO-Map Control**

Index (hex)	Name	Meaning	Data type	Flags	Default
1601:0	ENC RxPDO-Map Control	PDO Mapping RxPDO 2	UINT8	RO	0x06 (6 <sub>dec</sub> )
1601:01	SubIndex 001	1. PDO Mapping entry (object 0x7000 (ENC Outputs Ch.1), entry 0x01 (Enable latch C))	UINT32	RO	0x7000:01, 1
1601:02	SubIndex 002	2. PDO Mapping entry (object 0x7000 (ENC Outputs Ch.1), entry 0x02 (Enable latch extern on positive edge))	UINT32	RO	0x7000:02, 1
1601:03	SubIndex 003	3. PDO Mapping entry (object 0x7000 (ENC Outputs Ch.1), entry 0x03 (Set counter))	UINT32	RO	0x7000:03, 1
1601:04	SubIndex 004	4. PDO Mapping entry (object 0x7000 (ENC Outputs Ch.1), entry 0x04 (Enable latch extern on negative edge))	UINT32	RO	0x7000:04, 1
1601:05	SubIndex 005	5. PDO Mapping entry (12 bits align)	UINT32	RO	0x0000:00, 12
1601:06	SubIndex 006	6. PDO Mapping entry (object 0x7000 (ENC Outputs Ch.1), entry 0x11 (Set counter value))	UINT32	RO	0x7000:11, 32

**Index 1602 STM RxPDO-Map Control**

Index (hex)	Name	Meaning	Data type	Flags	Default
1602:0	STM RxPDO-Map Control	PDO Mapping RxPDO 3	UINT8	RO	0x06 (6 <sub>dec</sub> )
1602:01	SubIndex 001	1. PDO Mapping entry (object 0x7010 (STM Outputs Ch.1), entry 0x01 (Enable))	UINT32	RO	0x7010:01, 1
1602:02	SubIndex 002	2. PDO Mapping entry (object 0x7010 (STM Outputs Ch.1), entry 0x02 (Reset))	UINT32	RO	0x7010:02, 1
1602:03	SubIndex 003	3. PDO Mapping entry (object 0x7010 (STM Outputs Ch.1), entry 0x03 (Reduce torque))	UINT32	RO	0x7010:03, 1
1602:04	SubIndex 004	4. PDO Mapping entry (8 bits align)	UINT32	RO	0x0000:00, 8
1602:05	SubIndex 005	5. PDO Mapping entry (object 0x7010 (STM Outputs Ch.1), entry 0x0C (Digital output 1))	UINT32	RO	0x7010:0C, 1
1602:06	SubIndex 006	6. PDO Mapping entry (4 bits align)	UINT32	RO	0x0000:00, 4

**Index 1603 STM RxPDO-Map Position**

Index (hex)	Name	Meaning	Data type	Flags	Default
1603:0	STM RxPDO-Map Position	PDO Mapping RxPDO 4	UINT8	RO	0x01 (1 <sub>dec</sub> )
1603:01	SubIndex 001	1. PDO Mapping entry (object 0x7010 (STM Outputs Ch.1), entry 0x11 (Position))	UINT32	RO	0x7010:11, 32

**Index 1604 STM RxPDO-Map Velocity**

Index (hex)	Name	Meaning	Data type	Flags	Default
1604:0	STM RxPDO-Map Velocity	PDO Mapping RxPDO 5	UINT8	RO	0x01 (1 <sub>dec</sub> )
1604:01	SubIndex 001	1. PDO Mapping entry (object 0x7010 (STM Outputs Ch.1), entry 0x21 (Velocity))	UINT32	RO	0x7010:21, 16

**Index 1605 POS RxPDO-Map Control compact**

Index (hex)	Name	Meaning	Data type	Flags	Default
1605:0	POS RxPDO-Map Control compact	PDO Mapping RxPDO 6	UINT8	RO	0x04 (4 <sub>dec</sub> )
1605:01	SubIndex 001	1. PDO Mapping entry (object 0x7020 (POS Outputs Ch.1), entry 0x01 (Execute))	UINT32	RO	0x7020:01, 1
1605:02	SubIndex 002	2. PDO Mapping entry (object 0x7020 (POS Outputs Ch.1), entry 0x02 (Emergency stop))	UINT32	RO	0x7020:02, 1
1605:03	SubIndex 003	3. PDO Mapping entry (14 bits align)	UINT32	RO	0x0000:00, 14
1605:04	SubIndex 004	4. PDO Mapping entry (object 0x7020 (POS Outputs Ch.1), entry 0x11 (Target position))	UINT32	RO	0x7020:11, 32

**Index 1606 POS RxPDO-Map Control**

Index (hex)	Name	Meaning	Data type	Flags	Default
1606:0	POS RxPDO-Map Control	PDO Mapping RxPDO 7	UINT8	RO	0x08 (8 <sub>dec</sub> )
1606:01	SubIndex 001	1. PDO Mapping entry (object 0x7020 (POS Outputs Ch.1), entry 0x01 (Execute))	UINT32	RO	0x7020:01, 1
1606:02	SubIndex 002	2. PDO Mapping entry (object 0x7020 (POS Outputs Ch.1), entry 0x02 (Emergency stop))	UINT32	RO	0x7020:02, 1
1606:03	SubIndex 003	3. PDO Mapping entry (14 bits align)	UINT32	RO	0x0000:00, 14
1606:04	SubIndex 004	4. PDO Mapping entry (object 0x7020 (POS Outputs Ch.1), entry 0x11 (Target position))	UINT32	RO	0x7020:11, 32
1606:05	SubIndex 005	5. PDO Mapping entry (object 0x7020 (POS Outputs Ch.1), entry 0x21 (Velocity))	UINT32	RO	0x7020:21, 16
1606:06	SubIndex 006	6. PDO Mapping entry (object 0x7020 (POS Outputs Ch.1), entry 0x22 (Start type))	UINT32	RO	0x7020:22, 16
1606:07	SubIndex 007	7. PDO Mapping entry (object 0x7020 (POS Outputs Ch.1), entry 0x23 (Acceleration))	UINT32	RO	0x7020:23, 16
1606:08	SubIndex 008	8. PDO Mapping entry (object 0x7020 (POS Outputs Ch.1), entry 0x24 (Deceleration))	UINT32	RO	0x7020:24, 16

**Index 1607 POS RxPDO-Map Control 2**

Index (hex)	Name	Meaning	Data type	Flags	Default
1607:0	POS RxPDO-Map Control 2	PDO Mapping RxPDO 8	UINT8	RO	0x08 (8 <sub>dec</sub> )
1607:01	SubIndex 001	1. PDO Mapping entry (2 bits align)	UINT32	RO	0x0000:00,2
1607:02	SubIndex 002	2. PDO Mapping entry (object 0x7021 (POS Outputs 2 Ch.1), entry 0x03 (Enable auto start))	UINT32	RO	0x7021:03, 1
1607:03	SubIndex 003	3. PDO Mapping entry (13 bits align)	UINT32	RO	0x0000:00, 13
1607:04	SubIndex 004	4. PDO Mapping entry (object 0x7021 (POS Outputs 2 Ch.1), entry 0x11 (Target position))	UINT32	RO	0x7021:11, 32
1607:05	SubIndex 005	5. PDO Mapping entry (object 0x7021 (POS Outputs 2 Ch.1), entry 0x21 (Velocity))	UINT32	RO	0x7021:21, 16
1607:06	SubIndex 006	6. PDO Mapping entry (object 0x7021 (POS Outputs 2 Ch.1), entry 0x22 (Start type))	UINT32	RO	0x7021:22, 16
1607:07	SubIndex 007	7. PDO Mapping entry (object 0x7021 (POS Outputs 2 Ch.1), entry 0x23 (Acceleration))	UINT32	RO	0x7021:23, 16
1607:08	SubIndex 008	8. PDO Mapping entry (object 0x7021 (POS Outputs 2 Ch.1), entry 0x24 (Deceleration))	UINT32	RO	0x7021:24, 16

**Index 1800 ENC TxPDO-Par Status compact**

Index (hex)	Name	Meaning	Data type	Flags	Default
1800:0	ENC TxPDO-Par Status compact	PDO parameter TxPDO 1	UINT8	RO	0x06 (6 <sub>dec</sub> )
1800:06	Exclude TxPDOs	Specifies the TxPDOs (index of TxPDO mapping objects) that must not be transferred together with TxPDO 1	OCTET-STRING[2]	RO	01 1A

**Index 1801 ENC TxPDO-Par Status**

Index (hex)	Name	Meaning	Data type	Flags	Default
1801:0	ENC TxPDO-Par Status	PDO parameter TxPDO 2	UINT8	RO	0x06 (6 <sub>dec</sub> )
1801:06	Exclude TxPDOs	Specifies the TxPDOs (index of TxPDO mapping objects) that must not be transferred together with TxPDO 2.	OCTET-STRING[2]	RO	00 1A

**Index 1806 POS TxPDO-Par Status compact**

Index (hex)	Name	Meaning	Data type	Flags	Default
1806:0	POS TxPDO-Par Status compact	PDO parameter TxPDO 7	UINT8	RO	0x06 (6 <sub>dec</sub> )
1806:06	Exclude TxPDOs	Specifies the TxPDOs (index of TxPDO mapping objects) that must not be transferred together with TxPDO 7.	OCTET-STRING[2]	RO	07 1A

**Index 1807 POS TxPDO-Par Status**

Index (hex)	Name	Meaning	Data type	Flags	Default value
1807:0	POS TxPDO-Par Status	PDO parameter TxPDO 8	UINT8	RO	0x06 (6 <sub>dec</sub> )
1807:06	Exclude TxPDOs	Specifies the TxPDOs (index of TxPDO mapping objects) that must not be transferred together with TxPDO 8.	OCTET-STRING[2]	RO	06 1A

**Index 1A00 ENC TxPDO-Map Status compact**

Index (hex)	Name	Meaning	Data type	Flags	Default
1A00:0	ENC TxPDO-Map Status compact	PDO Mapping TxPDO 1	UINT8	RO	0x11 (17 <sub>dec</sub> )
1A00:01	SubIndex 001	1. PDO Mapping entry (object 0x6000 (ENC Inputs Ch. 1), entry 0x01 (Latch C valid))	UINT32	RO	0x6000:01, 1
1A00:02	SubIndex 002	2. PDO Mapping entry (object 0x6000 (ENC Inputs Ch. 1), entry 0x02 (Latch extern valid))	UINT32	RO	0x6000:02, 1
1A00:03	SubIndex 003	3. PDO Mapping entry (object 0x6000 (ENC Inputs Ch. 1), entry 0x03 (Set counter done))	UINT32	RO	0x6000:03, 1
1A00:04	SubIndex 004	4. PDO Mapping entry (object 0x6000 (ENC Inputs Ch. 1), entry 0x04 (Counter underflow))	UINT32	RO	0x6000:04, 1
1A00:05	SubIndex 005	5. PDO Mapping entry (object 0x6000 (ENC Inputs Ch. 1), entry 0x05 (Counter overflow))	UINT32	RO	0x6000:05, 1
1A00:06	SubIndex 006	6. PDO Mapping entry (2 bits align)	UINT32	RO	0x0000:00, 2
1A00:07	SubIndex 007	7. PDO Mapping entry (object 0x6000 (ENC Inputs Ch. 1), entry 0x08 (Extrapolation stall))	UINT32	RO	0x6000:08, 1
1A00:08	SubIndex 008	8. PDO Mapping entry (object 0x6000 (ENC Inputs Ch. 1), entry 0x09 (Status of input A))	UINT32	RO	0x6000:09, 1
1A00:09	SubIndex 009	9. PDO Mapping entry (object 0x6000 (ENC Inputs Ch. 1), entry 0x0A (Status of input B))	UINT32	RO	0x6000:0A, 1
1A00:0A	SubIndex 010	10. PDO Mapping entry (object 0x6000 (ENC Inputs Ch. 1), entry 0x0B (Status of input C))	UINT32	RO	0x6000:0B, 1
1A00:0B	SubIndex 011	11. PDO Mapping entry (1 bit align)	UINT32	RO	0x0000:00, 1
1A00:0C	SubIndex 012	12. PDO Mapping entry (object 0x6000 (ENC Inputs Ch. 1), entry 0x0D (Status of extern latch))	UINT32	RO	0x6000:0D, 1
1A00:0D	SubIndex 013	13. PDO Mapping entry (object 0x6000 (ENC Inputs Ch. 1), entry 0x0E (Sync error))	UINT32	RO	0x6000:0E, 1
1A00:0E	SubIndex 014	14. PDO Mapping entry (1 bit align)	UINT32	RO	0x0000:00, 1
1A00:0F	SubIndex 015	15. PDO Mapping entry (object 0x6000 (ENC Inputs Ch. 1), entry 0x10 (TxPDO Toggle))	UINT32	RO	0x6000:10, 1
1A00:10	SubIndex 016	16. PDO Mapping entry (object 0x6000 (ENC Inputs Ch. 1), entry 0x11 (Counter value))	UINT32	RO	0x6000:11, 16
1A00:11	SubIndex 017	17. PDO Mapping entry (object 0x6000 (ENC Inputs Ch. 1), entry 0x12 (Latch value))	UINT32	RO	0x6000:12, 16

## Index 1A01 ENC TxPDO-Map Status

Index (hex)	Name	Meaning	Data type	Flags	Default
1A01:0	ENC TxPDO-Map Status compact	PDO Mapping TxPDO 1	UINT8	RO	0x11 (17 <sub>dec</sub> )
1A01:01	SubIndex 001	1. PDO Mapping entry (object 0x6000 (ENC Inputs Ch. 1), entry 0x01 (Latch C valid))	UINT32	RO	0x6000:01, 1
1A01:02	SubIndex 002	2. PDO Mapping entry (object 0x6000 (ENC Inputs Ch. 1), entry 0x02 (Latch extern valid))	UINT32	RO	0x6000:02, 1
1A01:03	SubIndex 003	3. PDO Mapping entry (object 0x6000 (ENC Inputs Ch. 1), entry 0x03 (Set counter done))	UINT32	RO	0x6000:03, 1
1A01:04	SubIndex 004	4. PDO Mapping entry (object 0x6000 (ENC Inputs Ch. 1), entry 0x04 (Counter underflow))	UINT32	RO	0x6000:04, 1
1A01:05	SubIndex 005	5. PDO Mapping entry (object 0x6000 (ENC Inputs Ch. 1), entry 0x05 (Counter overflow))	UINT32	RO	0x6000:05, 1
1A01:06	SubIndex 006	6. PDO Mapping entry (2 bits align)	UINT32	RO	0x0000:00, 2
1A01:07	SubIndex 007	7. PDO Mapping entry (object 0x6000 (ENC Inputs Ch. 1), entry 0x08 (Extrapolation stall))	UINT32	RO	0x6000:08, 1
1A01:08	SubIndex 008	8. PDO Mapping entry (object 0x6000 (ENC Inputs Ch. 1), entry 0x09 (Status of input A))	UINT32	RO	0x6000:09, 1
1A01:09	SubIndex 009	9. PDO Mapping entry (object 0x6000 (ENC Inputs Ch. 1), entry 0x0A (Status of input B))	UINT32	RO	0x6000:0A, 1
1A01:0A	SubIndex 010	10. PDO Mapping entry (object 0x6000 (ENC Inputs Ch. 1), entry 0x0B (Status of input C))	UINT32	RO	0x6000:0B, 1
1A01:0B	SubIndex 011	11. PDO Mapping entry (1 bit align)	UINT32	RO	0x0000:00, 1
1A01:0C	SubIndex 012	12. PDO Mapping entry (object 0x6000 (ENC Inputs Ch. 1), entry 0x0D (Status of extern latch))	UINT32	RO	0x6000:0D, 1
1A01:0D	SubIndex 013	13. PDO Mapping entry (object 0x6000 (ENC Inputs Ch. 1), entry 0x0E (Sync error))	UINT32	RO	0x6000:0E, 1
1A01:0E	SubIndex 014	14. PDO Mapping entry (1 bit align)	UINT32	RO	0x0000:00, 1
1A01:0F	SubIndex 015	15. PDO Mapping entry (object 0x6000 (ENC Inputs Ch. 1), entry 0x10 (TxPDO Toggle))	UINT32	RO	0x6000:10, 1
1A01:10	SubIndex 016	16. PDO Mapping entry (object 0x6000 (ENC Inputs Ch. 1), entry 0x11 (Counter value))	UINT32	RO	0x6000:11, 32
1A01:11	SubIndex 017	17. PDO Mapping entry (object 0x6000 (ENC Inputs Ch. 1), entry 0x12 (Latch value))	UINT32	RO	0x6000:12, 32

## Index 1A02 ENC TxPDO-Map Timest. compact

Index (hex)	Name	Meaning	Data type	Flags	Default
1A02:0	ENC TxPDO-Map Timest. compact	PDO Mapping TxPDO 3	UINT8	RO	0x01 (1 <sub>dec</sub> )
1A02:01	SubIndex 001	1. PDO Mapping entry (object 0x6000 (ENC Inputs Ch.1), entry 0x16 (Timestamp))	UINT32	RO	0x6000:16, 32



**Index 1A03 STM TxPDO-Map Status**

Index (hex)	Name	Meaning	Data type	Flags	Default
1A03:0	STM TxPDO-Map Status	PDO Mapping TxPDO 4	UINT8	RO	0x0E (14 <sub>dec</sub> )
1A03:01	SubIndex 001	1. PDO Mapping entry (object 0x6010 (STM Inputs Ch.1), entry 0x01 (Ready to enable))	UINT32	RO	0x6010:01, 1
1A03:02	SubIndex 002	2. PDO Mapping entry (object 0x6010 (STM Inputs Ch.1), entry 0x02 (Ready))	UINT32	RO	0x6010:02, 1
1A03:03	SubIndex 003	3. PDO Mapping entry (object 0x6010 (STM Inputs Ch.1), entry 0x03 (Warning))	UINT32	RO	0x6010:03, 1
1A03:04	SubIndex 004	4. PDO Mapping entry (object 0x6010 (STM Inputs Ch.1), entry 0x04 (Error))	UINT32	RO	0x6010:04, 1
1A03:05	SubIndex 005	5. PDO Mapping entry (object 0x6010 (STM Inputs Ch.1), entry 0x05 (Moving positive))	UINT32	RO	0x6010:05, 1
1A03:06	SubIndex 006	6. PDO Mapping entry (object 0x6010 (STM Inputs Ch.1), entry 0x06 (Moving negative))	UINT32	RO	0x6010:06, 1
1A03:07	SubIndex 007	7. PDO Mapping entry (object 0x6010 (STM Inputs Ch.1), entry 0x07 (Torque reduced))	UINT32	RO	0x6010:07, 1
1A03:08	SubIndex 008	8. PDO Mapping entry (object 0x6010 (STM Inputs Ch.1), entry 0x08 (Motor stall))	UINT32	RO	0x6010:08, 1
1A03:09	SubIndex 009	9. PDO Mapping entry (3 bits align)	UINT32	RO	0x0000:00, 3
1A03:0A	SubIndex 010	10. PDO Mapping entry (object 0x6010 (STM Inputs Ch.1), entry 0x0C (Digital input 1))	UINT32	RO	0x6010:0C, 1
1A03:0B	SubIndex 011	11. PDO Mapping entry (object 0x6010 (STM Inputs Ch.1), entry 0x0D (Digital input 2))	UINT32	RO	0x6010:0D, 1
1A03:0C	SubIndex 012	12. PDO Mapping entry (object 0x6010 (STM Inputs Ch.1), entry 0x0E (Sync error))	UINT32	RO	0x6010:0E, 1
1A03:0D	SubIndex 013	13. PDO Mapping entry (1 bit align)	UINT32	RO	0x0000:00, 1
1A03:0E	SubIndex 014	14. PDO Mapping entry (object 0x6010 (STM Inputs Ch.1), entry 0x10 (TxPDO Toggle))	UINT32	RO	0x6010:10, 1

**Index 1A04 STM TxPDO-Map Synchron info data**

Index (hex)	Name	Meaning	Data type	Flags	Default
1A04:0	STM TxPDO-Map Synchron info data	PDO Mapping TxPDO 5	UINT8	RO	0x02 (2 <sub>dec</sub> )
1A04:01	SubIndex 001	1. PDO Mapping entry (object 0x6010 (STM Inputs Ch.1), entry 0x11 (Info data 1))	UINT32	RO	0x6010:11, 16
1A04:02	SubIndex 002	2. PDO Mapping entry (object 0x6010 (STM Inputs Ch.1), entry 0x12 (Info data 2))	UINT32	RO	0x6010:12, 16

**Index 1A05 STM TxPDO-Map Motor load**

Index (hex)	Name	Meaning	Data type	Flags	Default
1A05:0	STM TxPDO-Map Motor load	PDO Mapping TxPDO 6	UINT8	RO	0x01 (1 <sub>dec</sub> )
1A05:01	SubIndex 001	1. PDO Mapping entry (object 0x6010 (STM Inputs Ch.1), entry 0x13 (Motor load))	UINT32	RO	0x6010:13, 16

**Index 1A06 POS TxPDO-Map Status compact**

Index (hex)	Name	Meaning	Data type	Flags	Default
1A06:0	POS TxPDO-Map Status compact	PDO Mapping TxPDO 7	UINT8	RO	0x09 (9 <sub>dec</sub> )
1A06:01	SubIndex 001	1. PDO Mapping entry (object 0x6020 (POS Inputs Ch.1), entry 0x01 (Busy))	UINT32	RO	0x6020:01, 1
1A06:02	SubIndex 002	2. PDO Mapping entry (object 0x6020 (POS Inputs Ch.1), entry 0x02 (In target))	UINT32	RO	0x6020:02, 1
1A06:03	SubIndex 003	3. PDO Mapping entry (object 0x6020 (POS Inputs Ch.1), entry 0x03 (Warning))	UINT32	RO	0x6020:03, 1
1A06:04	SubIndex 004	4. PDO Mapping entry (object 0x6020 (POS Inputs Ch.1), entry 0x04 (Error))	UINT32	RO	0x6020:04, 1
1A06:05	SubIndex 005	5. PDO Mapping entry (object 0x6020 (POS Inputs Ch.1), entry 0x05 (Calibrated))	UINT32	RO	0x6020:05, 1
1A06:06	SubIndex 006	6. PDO Mapping entry (object 0x6020 (POS Inputs Ch.1), entry 0x06 (Accelerate))	UINT32	RO	0x6020:06, 1
1A06:07	SubIndex 007	7. PDO Mapping entry (object 0x6020 (POS Inputs Ch.1), entry 0x07 (Decelerate))	UINT32	RO	0x6020:07, 1
1A06:08	SubIndex 008	8. PDO Mapping entry (object 0x6020 (POS Inputs Ch.1), entry 0x08 (Ready to execute))	UINT32	RO	0x6020:08, 1
1A06:09	SubIndex 009	9. PDO Mapping entry (8 bits align)	UINT32	RO	0x0000:00, 8

**Index 1A07 POS TxPDO-Map Status**

Index (hex)	Name	Meaning	Data type	Flags	Default
1A07:0	POS TxPDO-Map Status	PDO Mapping TxPDO 8	UINT8	RO	0x0C (12 <sub>dec</sub> )
1A07:01	SubIndex 001	1. PDO Mapping entry (object 0x6020 (POS Inputs Ch.1), entry 0x01 (Busy))	UINT32	RO	0x6020:01, 1
1A07:02	SubIndex 002	2. PDO Mapping entry (object 0x6020 (POS Inputs Ch.1), entry 0x02 (In target))	UINT32	RO	0x6020:02, 1
1A07:03	SubIndex 003	3. PDO Mapping entry (object 0x6020 (POS Inputs Ch.1), entry 0x03 (Warning))	UINT32	RO	0x6020:03, 1
1A07:04	SubIndex 004	4. PDO Mapping entry (object 0x6020 (POS Inputs Ch.1), entry 0x04 (Error))	UINT32	RO	0x6020:04, 1
1A07:05	SubIndex 005	5. PDO Mapping entry (object 0x6020 (POS Inputs Ch.1), entry 0x05 (Calibrated))	UINT32	RO	0x6020:05, 1
1A07:06	SubIndex 006	6. PDO Mapping entry (object 0x6020 (POS Inputs Ch.1), entry 0x06 (Accelerate))	UINT32	RO	0x6020:06, 1
1A07:07	SubIndex 007	7. PDO Mapping entry (object 0x6020 (POS Inputs Ch.1), entry 0x07 (Decelerate))	UINT32	RO	0x6020:07, 1
1A07:08	SubIndex 008	8. PDO Mapping entry (object 0x6020 (POS Inputs Ch.1), entry 0x08 (Ready to execute))	UINT32	RO	0x6020:08, 1
1A07:09	SubIndex 009	9. PDO Mapping entry (8 bits align)	UINT32	RO	0x0000:00, 8
1A07:0A	SubIndex 010	10. PDO Mapping entry (object 0x6020 (POS Inputs Ch.1), entry 0x11 (Actual position))	UINT32	RO	0x6020:11, 32
1A07:0B	SubIndex 011	11. PDO Mapping entry (object 0x6020 (POS Inputs Ch.1), entry 0x21 (Actual velocity))	UINT32	RO	0x6020:21, 16
1A07:0C	SubIndex 012	12. PDO Mapping entry (object 0x6020 (POS Inputs Ch.1), entry 0x22 (Actual drive time))	UINT32	RO	0x6020:22, 32

**Index 1A08 STM TxPDO-Map Internal position**

Index (hex)	Name	Meaning	Data type	Flags	Default
1A08:0	STM TxPDO-Map Internal position	PDO Mapping TxPDO 9	UINT8	RO	0x01 (1 <sub>dec</sub> )
1A08:01	SubIndex 001	1. PDO Mapping entry (object 0x6010 (STM Inputs Ch.1), entry 0x14 (Internal position))	UINT32	RO	0x6010:14, 32

**Index 1A09 STM TxPDO-Map External position**

Index (hex)	Name	Meaning	Data type	Flags	Default
1A09:0	STM TxPDO-Map External position	PDO Mapping TxPDO 10	UINT8	RO	0x01 (1 <sub>dec</sub> )
1A09:01	SubIndex 001	1. PDO Mapping entry (object 0x6010 (STM Inputs Ch.1), entry 0x15 (External position))	UINT32	RO	0x6010:15, 32

**Index 1A0A POS TxPDO-Map Actual position lag**

Index (hex)	Name	Meaning	Data type	Flags	Default
1A0A:0	POS TxPDO-Map Actual position lag	PDO Mapping TxPDO 11	UINT8	RO	0x01 (1 <sub>dec</sub> )
1A0A:01	SubIndex 001	1. PDO Mapping entry (object 0x6020 (POS Inputs Ch.1), entry 0x23 (Actual position lag))	UINT32	RO	0x6020:23, 32

**Index 1C00 Sync manager type**

Index (hex)	Name	Meaning	Data type	Flags	Default
1C00:0	Sync manager type	Using the Sync Managers	UINT8	RO	0x04 (4 <sub>dec</sub> )
1C00:01	SubIndex 001	Sync-Manager Type Channel 1: Mailbox Write	UINT8	RO	0x01 (1 <sub>dec</sub> )
1C00:02	SubIndex 002	Sync-Manager Type Channel 2: Mailbox Read	UINT8	RO	0x02 (2 <sub>dec</sub> )
1C00:03	SubIndex 003	Sync-Manager Type Channel 3: Process Data Write (Outputs)	UINT8	RO	0x03 (3 <sub>dec</sub> )
1C00:04	SubIndex 004	Sync-Manager Type Channel 4: Process Data Read (Inputs)	UINT8	RO	0x04 (4 <sub>dec</sub> )

**Index 1C12 RxPDO assign**

Index (hex)	Name	Meaning	Data type	Flags	Default
1C12:0	RxPDO assign	Using the Sync Managers	UINT8	RW	0x03 (3 <sub>dec</sub> )
1C12:01	SubIndex 001	1. allocated RxPDO (contains the index of the associated RxPDO mapping object)	UINT16	RW	0x1600 (5632 <sub>dec</sub> )
1C12:02	SubIndex 002	2. allocated RxPDO (contains the index of the associated RxPDO mapping object)	UINT16	RW	0x1602 (5634 <sub>dec</sub> )
1C12:03	SubIndex 003	3. allocated RxPDO (contains the index of the associated RxPDO mapping object)	UINT16	RW	0x1604 (5636 <sub>dec</sub> )

**Index 1C13 TxPDO assign**

Index (hex)	Name	Meaning	Data type	Flags	Default
1C13:0	TxPDO assign	PDO Assign Inputs	UINT8	RO	0x02 (2 <sub>dec</sub> )
1C13:01	SubIndex 001	1. allocated TxPDO (contains the index of the associated TxPDO mapping object)	UINT16	RO	0x1A00 (6656 <sub>dec</sub> )
1C13:02	SubIndex 002	2. allocated TxPDO (contains the index of the associated TxPDO mapping object)	UINT16	RO	0x1A03 (6659 <sub>dec</sub> )

## Index 1C32 SM output parameter (part 1)

Index (hex)	Name	Meaning	Data type	Flags	Default
1C32:0	SM output parameter	Synchronization parameters for the outputs	UINT8	RO	0x20 (32 <sub>dec</sub> )
1C32:01	Sync mode	Current synchronization mode: <ul style="list-style-type: none"> <li>0: Free Run</li> <li>1: Synchron with SM 2 Event</li> <li>2: DC-Mode - Synchron with SYNC0 Event</li> <li>3: DC-Mode - Synchron with SYNC1 Event</li> </ul>	UINT16	RW	0x0001 (1 <sub>dec</sub> )
1C32:02	Cycle time	Cycle time (in ns): <ul style="list-style-type: none"> <li>Free Run: Cycle time of the local timer</li> <li>Synchron with SM 2 Event: Master cycle time</li> <li>DC mode: SYNC0/SYNC1 Cycle Time</li> </ul>	UINT32	RW	0x000F4240 (1000000 <sub>dec</sub> )
1C32:03	Shift time	Time between SYNC0 event and output of the outputs (in ns, DC mode only)	UINT32	RO	0x00000000 (0 <sub>dec</sub> )
1C32:04	Sync modes supported	Supported synchronization modes: <ul style="list-style-type: none"> <li>Bit 0 = 1: free run is supported</li> <li>Bit 1 = 1: Synchron with SM 2 Event is supported</li> <li>Bit 2-3 = 01: DC mode is supported</li> <li>Bit 4-5 = 10: Output Shift with SYNC1 event (only DC mode)</li> <li>Bit 14 = 1: dynamic times (measurement through writing of 0x1C32:08)</li> </ul>	UINT16	RO	0x0C07 (3079 <sub>dec</sub> )
1C32:05	Minimum cycle time	Minimum cycle time (in ns)	UINT32	RO	0x0003D090 (250000 <sub>dec</sub> )
1C32:06	Calc and copy time	Minimum time between SYNC0 and SYNC1 event (in ns, DC mode only)	UINT32	RO	0x00000000 (0 <sub>dec</sub> )
1C32:07	Minimum delay time	Min. time between SYNC1 event and output of the outputs (in ns, DC mode only)	UINT32	RO	0x00000000 (0 <sub>dec</sub> )
1C32:08	Command	<ul style="list-style-type: none"> <li>0: Measurement of the local cycle time is stopped</li> <li>1: Measurement of the local cycle time is started</li> </ul> <p>Entries 0x1C32:03, 0x1C32:05, 0x1C32:06, 0x1C32:07, 0x1C32:09, 0x1C33:03, 0x1C33:06, 0x1C33:09 are updated with the maximum measured values. For a subsequent measurement the measured values are reset.</p>	UINT16	RW	0x0000 (0 <sub>dec</sub> )
1C32:09	Maximum delay time	Max. time between SYNC1 event and output of the outputs (in ns, DC mode only)	UINT32	RO	0x00000000 (0 <sub>dec</sub> )
1C32:0B	SM event missed counter	Number of missed SM events in OPERATIONAL (DC mode only)	UINT16	RO	0x0000 (0 <sub>dec</sub> )
1C32:0C	Cycle exceeded counter	Number of occasions the cycle time was exceeded in OPERATIONAL (cycle was not completed in time or the next cycle began too early)	UINT16	RO	0x0000 (0 <sub>dec</sub> )
1C32:0D	Shift too short counter	Number of occasions that the interval between SYNC0 and SYNC1 event was too short (DC mode only)	UINT16	RO	0x0000 (0 <sub>dec</sub> )
1C32:14	Frame repeat time		UINT32	RW	0x00000000 (0 <sub>dec</sub> )
1C32:20	Sync error	The synchronization was not correct in the last cycle (outputs were output too late; DC mode only)	BOOLEAN	RO	0x00 (0 <sub>dec</sub> )

**Index 1C33 SM input parameter**

Index (hex)	Name	Meaning	Data type	Flags	Default
1C33:0	SM input parameter	Synchronization parameters for the inputs	UINT8	RO	0x20 (32 <sub>dec</sub> )
1C33:01	Sync mode	Current synchronization mode: <ul style="list-style-type: none"> <li>• 0: Free Run</li> <li>• 1: Synchron with SM 3 Event (no outputs available)</li> <li>• 2: DC - Synchron with SYNC0 Event</li> <li>• 3: DC - Synchron with SYNC1 Event</li> <li>• 34: Synchron with SM 2 Event (outputs available)</li> </ul>	UINT16	RW	0x0022 (34 <sub>dec</sub> )
1C33:02	Cycle time	Cycle time (in ns): <ul style="list-style-type: none"> <li>• Free Run: Cycle time of the local timer</li> <li>• Synchron with SM 2 Event: Master cycle time</li> <li>• DC mode: SYNC0/SYNC1 Cycle Time</li> </ul>	UINT32	RW	0x000F4240 (1000000 <sub>dec</sub> )
1C33:03	Shift time	Time between SYNC0 event and reading of the inputs (in ns, only DC mode)	UINT32	RO	0x00000000 (0 <sub>dec</sub> )
1C33:04	Sync modes supported	Supported synchronization modes: <ul style="list-style-type: none"> <li>• Bit 0: free run is supported</li> <li>• Bit 1: Synchron with SM 2 Event is supported (outputs available)</li> <li>• Bit 1: Synchron with SM 3 Event is supported (no outputs available)</li> <li>• Bit 2-3 = 01: DC mode is supported</li> <li>• Bit 4-5 = 01: Input Shift through local event (outputs available)</li> <li>• Bit 4-5 = 10: Input Shift with SYNC1 Event (no outputs available)</li> <li>• Bit 14 = 1: dynamic times (measurement through writing of 0x1C33:08)</li> </ul>	UINT16	RO	0x0C07 (3079 <sub>dec</sub> )
1C33:05	Minimum cycle time	Minimum cycle time (in ns)	UINT32	RO	0x0003D090 (250000 <sub>dec</sub> )
1C33:06	Calc and copy time	Time between reading of the inputs and availability of the inputs for the master (in ns, only DC mode)	UINT32	RO	0x00000000 (0 <sub>dec</sub> )
1C33:07	Minimum delay time	Min. time between SYNC1 event and the reading of the inputs (in ns, DC mode only)	UINT32	RO	0x00000000 (0 <sub>dec</sub> )
1C33:08	Command	With this entry the real required process data provision time can be measured. <ul style="list-style-type: none"> <li>• 0: Measurement of the local cycle time is stopped</li> <li>• 1: Measurement of the local cycle time is started</li> </ul> The entries 0x1C33:03, 0x1C33:06, 0x1C33:09 are updated with the maximum measured values. For a subsequent measurement the measured values are reset	UINT16	RW	0x0000 (0 <sub>dec</sub> )
1C33:09	Maximum Delay time	Time between SYNC1 event and reading of the inputs (in ns, only DC mode)	UINT32	RO	0x00000000 (0 <sub>dec</sub> )
1C33:0B	SM event missed counter	Number of missed SM events in OPERATIONAL (DC mode only)	UINT16	RO	0x0000 (0 <sub>dec</sub> )
1C33:0C	Cycle exceeded counter	Number of occasions the cycle time was exceeded in OPERATIONAL (cycle was not completed in time or the next cycle began too early)	UINT16	RO	0x0000 (0 <sub>dec</sub> )
1C33:0D	Shift too short counter	Number of occasions that the interval between SYNC0 and SYNC1 event was too short (DC mode only)	UINT16	RO	0x0000 (0 <sub>dec</sub> )
1C33:14	Frame repeat time		BOOLEAN	RO	0x00 (0 <sub>dec</sub> )
1C33:20	Sync error	The synchronization was not correct in the last cycle (outputs were output too late; DC mode only)	BOOLEAN	RO	0x00 (0 <sub>dec</sub> )

## 9 Appendix

### 9.1 Support and Service

Beckhoff and their partners around the world offer comprehensive support and service, making available fast and competent assistance with all questions related to Beckhoff products and system solutions.

#### Beckhoff's branch offices and representatives

Please contact your Beckhoff branch office or representative for local support and service on Beckhoff products!

The addresses of Beckhoff's branch offices and representatives round the world can be found on her internet pages: [www.beckhoff.com](http://www.beckhoff.com)

You will also find further documentation for Beckhoff components there.

#### Support

The Beckhoff Support offers you comprehensive technical assistance, helping you not only with the application of individual Beckhoff products, but also with other, wide-ranging services:

- support
- design, programming and commissioning of complex automation systems
- and extensive training program for Beckhoff system components

Hotline: +49 5246 963 157  
e-mail: [support@beckhoff.com](mailto:support@beckhoff.com)  
web: [www.beckhoff.com/support](http://www.beckhoff.com/support)

#### Service

The Beckhoff Service Center supports you in all matters of after-sales service:

- on-site service
- repair service
- spare parts service
- hotline service

Hotline: +49 5246 963 460  
e-mail: [service@beckhoff.com](mailto:service@beckhoff.com)  
web: [www.beckhoff.com/service](http://www.beckhoff.com/service)

#### Headquarters Germany

Beckhoff Automation GmbH & Co. KG

Hülshorstweg 20  
33415 Verl  
Germany

Phone: +49 5246 963 0  
e-mail: [info@beckhoff.com](mailto:info@beckhoff.com)  
web: [www.beckhoff.com](http://www.beckhoff.com)



More Information:  
[www.beckhoff.com/ej7xxx](http://www.beckhoff.com/ej7xxx)

Beckhoff Automation GmbH & Co. KG  
Hülshorstweg 20  
33415 Verl  
Germany  
Phone: +49 5246 9630  
[info@beckhoff.com](mailto:info@beckhoff.com)  
[www.beckhoff.com](http://www.beckhoff.com)

