

Documentation | EN

# EPP3752-0000

2 x 3-axis accelerometers





# Table of contents

<b>1 Foreword</b> .....	<b>5</b>
1.1 Notes on the documentation .....	5
1.2 Safety instructions .....	6
1.3 Documentation issue status .....	7
<b>2 Product group: EtherCAT P Box modules</b> .....	<b>8</b>
<b>3 Product overview</b> .....	<b>9</b>
3.1 Introduction .....	9
3.2 Technical data .....	10
3.3 Process image .....	12
<b>4 Mounting and cabling</b> .....	<b>13</b>
4.1 Mounting .....	13
4.1.1 Dimensions .....	13
4.1.2 Fixing.....	14
4.1.3 Functional earth (FE) .....	14
4.1.4 Nut torque for connectors.....	14
4.2 EtherCAT P .....	15
4.2.1 Connectors.....	16
4.2.2 Status LEDs .....	17
4.2.3 Conductor losses .....	18
4.3 UL Requirements .....	19
4.4 Disposal .....	20
<b>5 Commissioning/Configuration</b> .....	<b>21</b>
5.1 Integrating into a TwinCAT project.....	21
5.2 Acceleration sensors .....	22
5.2.1 Settings .....	23
5.2.2 Inclination measurement .....	27
5.3 Restore the delivery state .....	29
5.4 Decommissioning.....	30
<b>6 CoE parameters</b> .....	<b>31</b>
6.1 Object overview.....	31
6.2 Object description and parameterization.....	35
<b>7 Appendix</b> .....	<b>46</b>
7.1 General operating conditions .....	46
7.2 Accessories .....	47
7.3 Version identification of EtherCAT devices .....	48
7.3.1 General notes on marking.....	48
7.3.2 Version identification of EP/EPI/EPP/ER/ERI boxes.....	49
7.3.3 Beckhoff Identification Code (BIC).....	50
7.3.4 Electronic access to the BIC (eBIC).....	52
7.4 Support and Service.....	54



# 1 Foreword

## 1.1 Notes on the documentation

### Intended audience

This description is only intended for the use of trained specialists in control and automation engineering who are familiar with the applicable national standards.

It is essential that the documentation and the following notes and explanations are followed when installing and commissioning these components.

It is the duty of the technical personnel to use the documentation published at the respective time of each installation and commissioning.

The responsible staff must ensure that the application or use of the products described satisfy all the requirements for safety, including all the relevant laws, regulations, guidelines and standards.

### Disclaimer

The documentation has been prepared with care. The products described are, however, constantly under development.

We reserve the right to revise and change the documentation at any time and without prior announcement.

No claims for the modification of products that have already been supplied may be made on the basis of the data, diagrams and descriptions in this documentation.

### Trademarks

Beckhoff®, TwinCAT®, TwinCAT/BSD®, TC/BSD®, EtherCAT®, EtherCAT G®, EtherCAT G10®, EtherCAT P®, Safety over EtherCAT®, TwinSAFE®, XFC®, XTS® and XPlanar® are registered trademarks of and licensed by Beckhoff Automation GmbH. Other designations used in this publication may be trademarks whose use by third parties for their own purposes could violate the rights of the owners.

### Patent Pending

The EtherCAT Technology is covered, including but not limited to the following patent applications and patents: EP1590927, EP1789857, EP1456722, EP2137893, DE102015105702 with corresponding applications or registrations in various other countries.



EtherCAT® is registered trademark and patented technology, licensed by Beckhoff Automation GmbH, Germany.

### Copyright

© Beckhoff Automation GmbH & Co. KG, Germany.

The reproduction, distribution and utilization of this document as well as the communication of its contents to others without express authorization are prohibited.

Offenders will be held liable for the payment of damages. All rights reserved in the event of the grant of a patent, utility model or design.

## 1.2 Safety instructions

### Safety regulations

Please note the following safety instructions and explanations!  
Product-specific safety instructions can be found on following pages or in the areas mounting, wiring, commissioning etc.

### Exclusion of liability

All the components are supplied in particular hardware and software configurations appropriate for the application. Modifications to hardware or software configurations other than those described in the documentation are not permitted, and nullify the liability of Beckhoff Automation GmbH & Co. KG.

### Personnel qualification

This description is only intended for trained specialists in control, automation and drive engineering who are familiar with the applicable national standards.

### Description of instructions

In this documentation the following instructions are used.  
These instructions must be read carefully and followed without fail!

#### DANGER

##### Serious risk of injury!

Failure to follow this safety instruction directly endangers the life and health of persons.

#### WARNING

##### Risk of injury!

Failure to follow this safety instruction endangers the life and health of persons.

#### CAUTION

##### Personal injuries!

Failure to follow this safety instruction can lead to injuries to persons.

#### NOTE

##### Damage to environment/equipment or data loss

Failure to follow this instruction can lead to environmental damage, equipment damage or data loss.



##### Tip or pointer

This symbol indicates information that contributes to better understanding.

### 1.3 Documentation issue status

Version	Comment
1.3	<ul style="list-style-type: none"> <li>EtherCAT P status LEDs updated</li> </ul>
1.2	<ul style="list-style-type: none"> <li>Chapter "Scaling of measured values" updated</li> <li>Structure update</li> </ul>
1.1	<ul style="list-style-type: none"> <li>Dimensions updated</li> <li>UL requirements updated</li> </ul>
1.0	<ul style="list-style-type: none"> <li>First release</li> </ul>

#### Firmware and hardware versions

This documentation refers to the firmware and hardware version that was applicable at the time the documentation was written.

The module features are continuously improved and developed further. Modules having earlier production statuses cannot have the same properties as modules with the latest status. However, existing properties are retained and are not changed, so that older modules can always be replaced with new ones.

Documentation	Firmware	Hardware
1.1	02	00
1.0	02	00

The firmware and hardware version (delivery state) can be found in the batch number (D-number) printed on the side of the EtherCAT Box.

#### Syntax of the batch number (D-number)

D: WW YY FF HH

- WW - week of production (calendar week)
- YY - year of production
- FF - firmware version
- HH - hardware version

Example with D no. 29 10 02 01:

- 29 - week of production 29
- 10 - year of production 2010
- 02 - firmware version 02
- 01 - hardware version 01

Further information on this topic: [Version identification of EtherCAT devices \[► 48\]](#).

## 2 Product group: EtherCAT P Box modules

### EtherCAT P

EtherCAT P supplements the EtherCAT technology with a process in which communication and supply voltages are transmitted on a common line. All EtherCAT properties are retained with this process.

Two supply voltages are transmitted per EtherCAT P line. The supply voltages are electrically isolated from each other and can therefore be switched individually. The nominal supply voltage for both is 24 V<sub>DC</sub>.

EtherCAT P uses the same cable structure as EtherCAT: a 4-core Ethernet cable with M8 connectors. The connectors are mechanically coded so that EtherCAT connectors and EtherCAT P connectors cannot be interchanged.

### EtherCAT P Box modules

EtherCAT P Box modules are EtherCAT P slaves with degree of protection IP67. They are designed for operation in wet, dirty or dusty industrial environments.

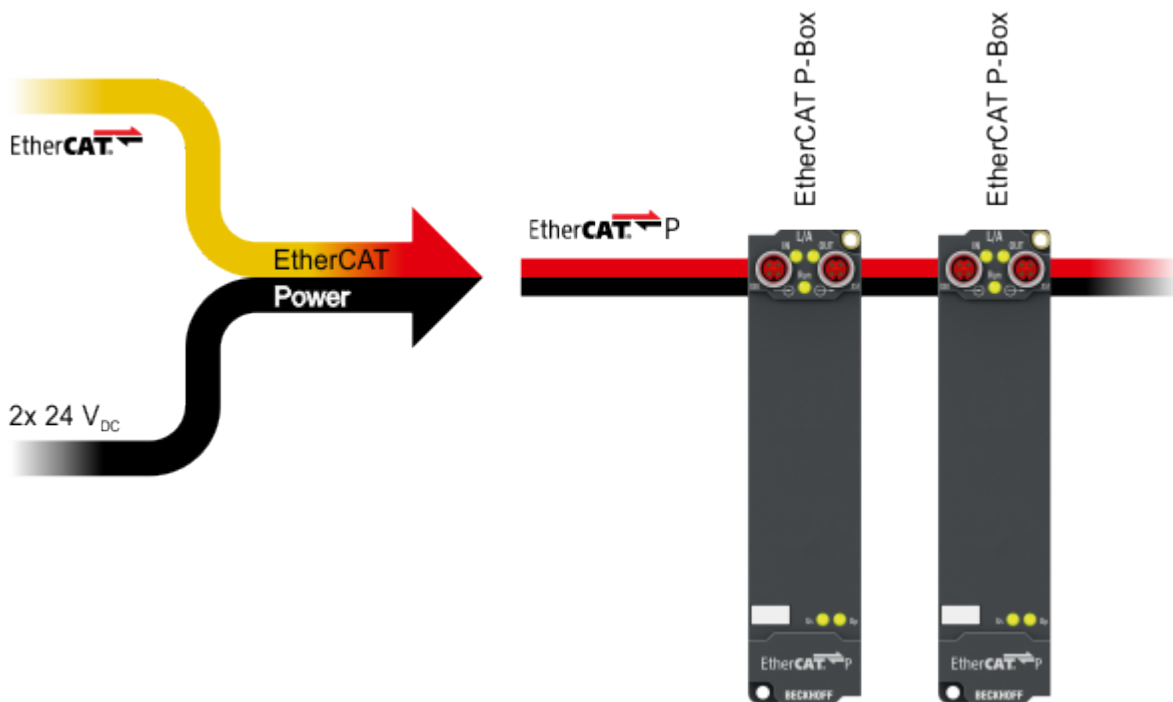

### EtherCAT basics

A detailed description of the EtherCAT system can be found in the [EtherCAT system documentation](#).



### 3 Product overview

#### 3.1 Introduction

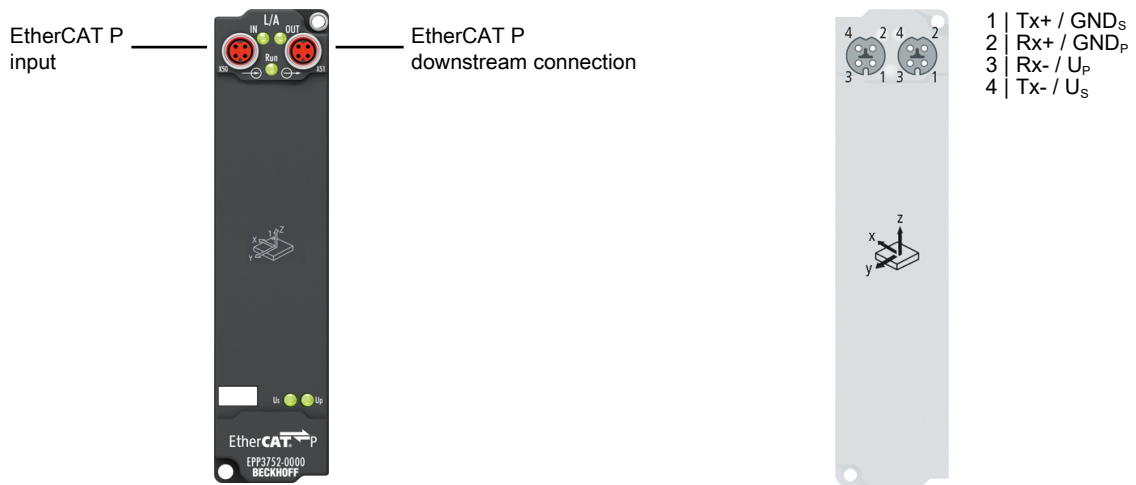

#### 2 x 3-axis accelerometers

The EPP3752-0000 EtherCAT P Box has two internal 3-axis accelerometers with 10 bits and a selectable measuring range of  $\pm 2$  g,  $\pm 4$  g,  $\pm 8$  g and  $\pm 16$  g. The sampling frequency is 1 Hz to 5 kHz. Possible applications include the recording of vibrations and shocks/oscillations, and furthermore inclination measurements in all three axes. Since measurement is carried out with two sensors that are positioned at an angle of  $90^\circ$  to each other, the control system can check measured data for plausibility. Extended integrated filter functions allow measured data to be pre-processed and appropriately scaled in order to filter disturbances and to relieve the workload of the control system.

## 3.2 Technical data

All values are typical values over the entire temperature range, unless stated otherwise.

EtherCAT P	
Connection	2 x M8 socket, 4-pin, P-coded, red
Minimum cycle time	200 µs

Supply voltages	
Connection	See EtherCAT P connection
$U_S$ nominal voltage	24 V <sub>DC</sub> (-15 % / +20 %)
$U_S$ sum current: $I_{S,sum}$	max. 3 A
Current consumption from $U_S$	100 mA
Rated voltage $U_P$	24 V <sub>DC</sub> (-15 % / +20 %)
$U_P$ sum current: $I_{P,sum}$	max. 3 A
Current consumption from $U_P$	None. $U_P$ is only forwarded.

Accelerometers	
Sensor type	Two 3-axis sensors / offset by 90°
Resolution <sup>1) 2)</sup>	Measured values: 4 mg (default) Raw values: 10-bit (default)
Representation <sup>1)</sup>	Measured values: 1 mg / LSB Raw values: 10-bit in 16-bit (left aligned)
Measuring range <sup>1)</sup>	±2 g / ±4 g / ±8 g / ±16 g selectively
Sampling rate	200 Hz to 5 kHz

<sup>1)</sup> Unit of measurement: 1 g = 9.81 m/s<sup>2</sup> (acceleration of gravity). 1 mg = 1/1000 g.

<sup>2)</sup> The resolution depends on the parameterization of the box. See section [Resolution](#) [► 11].

Housing data	
Dimensions W x H x D	30 mm x 126 mm x 26.5 mm (without connectors)
Weight	approx. 165 g
Installation position	variable
Material	PA6 (polyamide)

Environmental conditions	
Ambient temperature during operation	-25 ... +60 °C -25 ... +55 °C according to cULus
Ambient temperature during storage	-40 ... +85 °C
Vibration resistance, shock resistance	conforms to EN 60068-2-6 / EN 60068-2-27 Additional checks [► 11]
EMC immunity / emission	conforms to EN 61000-6-2 / EN 61000-6-4
Protection class	IP65, IP66, IP67 (conforms to EN 60529)

Approvals / markings	
Approvals / markings <sup>*)</sup>	CE, cULus [► 19]

<sup>\*)</sup> Real applicable approvals/markings see type plate on the side (product marking).

**Resolution**

The resolution of measured values and raw values depends on the parameters "Measuring range" and "Sampling rate". The table below shows how these parameters influence the resolution:

Measuring range	Sampling rate / EtherCAT cycle time	Resolution	
		Raw values	Measured values
±2 g	≤ 1 kHz / ≥ 1 ms	10-bit	4 mg
±4 g			8 mg
±8 g			16 mg
±16 g			48 mg
±2 g	> 1 kHz / < 1 ms	8-bit	16 mg
±4 g			32 mg
±8 g			64 mg
±16 g			192 mg

The setting of the "Measuring range" and "Sampling rate" parameters is described in the chapter [Settings](#) [▶ 23].

**Additional tests**

The devices have undergone the following additional tests:

Test	Explanation
Vibration	10 frequency sweeps in 3 axes
	5 Hz < f < 60 Hz displacement 0.35 mm, constant amplitude
	60.1 Hz < f < 500 Hz acceleration 5 g, constant amplitude
Shocks	1000 shocks in each direction, in 3 axes
	35 g, 11 ms

### 3.3 Process image

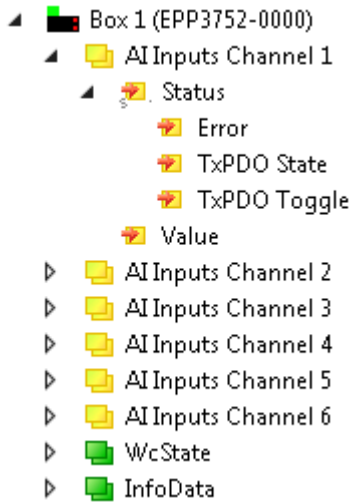

The data for the two accelerometers can be found under **AI Inputs Channel**.

- Status Error: An error occurred during communication with the accelerometer.
- Value: 16-bit acceleration value

The assignment of the process values to the sensor axes can be found in the chapter [Acceleration sensors](#) [► 22].

## 4 Mounting and cabling

### 4.1 Mounting

#### 4.1.1 Dimensions

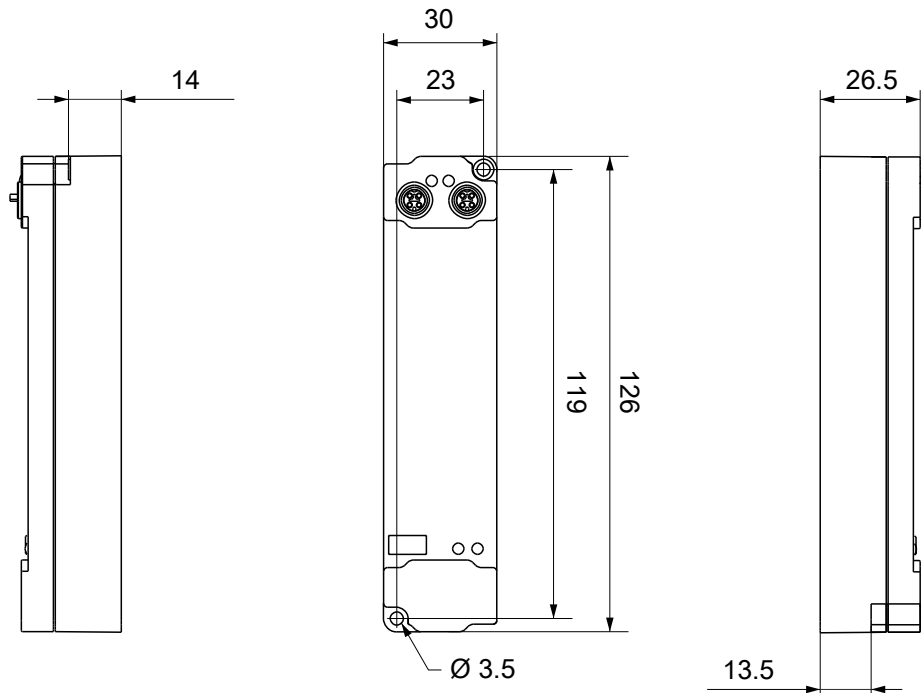

All dimensions are given in millimeters.  
The drawing is not true to scale.

#### Housing features

Housing material	PA6 (polyamide)
Sealing compound	polyurethane
Mounting	two mounting holes Ø 3.5 mm for M3
Metal parts	brass, nickel-plated
Contacts	CuZn, gold-plated
Installation position	variable
Protection class	IP65, IP66, IP67 (conforms to EN 60529) when screwed together
Dimensions (H x W x D)	approx. 126 x 30 x 26.5 mm (without connectors)

## 4.1.2 Fixing

### NOTE

#### Dirt during assembly

Dirty connectors can lead to malfunctions. Protection class IP67 can only be guaranteed if all cables and connectors are connected.

- Protect the plug connectors against dirt during the assembly.

Mount the module with two M3 screws on the mounting holes in the corners of the module. The mounting holes have no thread.

## 4.1.3 Functional earth (FE)

The upper mounting holes also serves as a connection for functional earth (FE).

Make sure that the box is grounded to low impedance via the functional earth (FE) connection. You can achieve this, for example, by mounting the box on a grounded machine bed.



Fig. 1: Connection for functional earth (FE)

## 4.1.4 Nut torque for connectors

Screw M8 connectors tight with a torque wrench. (e.g. ZB8801 from Beckhoff)  
Torque: 0.4 Nm.

## 4.2 EtherCAT P

### ⚠ WARNING

#### Power supply from SELV/PELV power supply unit!

SELV/PELV circuits (Safety Extra Low Voltage, Protective Extra Low Voltage) according to IEC 61010-2-201 must be used to supply the EtherCAT P Power Sourcing Device (PSD).

Notes:

- SELV/PELV circuits may give rise to further requirements from standards such as IEC 60204-1 et al, for example with regard to cable spacing and insulation.
- A SELV (Safety Extra Low Voltage) supply provides safe electrical isolation and limitation of the voltage without a connection to the protective conductor, a PELV (Protective Extra Low Voltage) supply also requires a safe connection to the protective conductor.

### ⚠ CAUTION

#### Observe the UL requirements

- When operating under UL conditions, observe the warnings in the chapter [UL Requirements](#) [▶ 19].

EtherCAT P transmits two supply voltages:

- **Control voltage  $U_s$**   
The following sub-functions are supplied from the control voltage  $U_s$ :
  - the fieldbus
  - the processor logic
  - typically the inputs and the sensors if the EtherCAT P Box has inputs.
- **Peripheral voltage  $U_p$**   
The digital outputs are typically supplied from the peripheral voltage  $U_p$  for EtherCAT P Box modules with digital outputs.  $U_p$  can be supplied separately. If  $U_p$  is switched off, the fieldbus function, the function of the inputs and the supply of the sensors are maintained.

The exact assignment of  $U_s$  and  $U_p$  can be found in the pin assignment of the I/O connections.

#### Redirection of the supply voltages

The supply voltages are passed on internally from the "IN" connection to the "OUT" connection. Hence, the supply voltages  $U_s$  and  $U_p$  can be passed from one EtherCAT P Box to the next EtherCAT P Box in a simple manner.

### NOTE

#### Note the maximum current.

Ensure that the maximum permitted current of 3 A for the M8 connectors is not exceeded when redirecting EtherCAT P.

### 4.2.1 Connectors

**NOTE**

**Risk of damage to the device!**  
 Bring the EtherCAT/EtherCAT P system into a safe, powered down state before starting installation, disassembly or wiring of the modules!

Two M8 sockets at the upper end of the modules are provided for supply and downstream connection of EtherCAT P:

- IN: left M8 socket for EtherCAT P supply
- OUT: right M8 socket for downstream connection of EtherCAT P

The metal threads of the M8 EtherCAT P sockets are internally linked to the FE connection via high impedance RC combination. See chapter [Functional earth \(FE\)](#) [► 14].



Fig. 2: Connectors for EtherCAT P

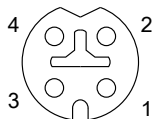

Fig. 3: M8 socket, p-coded

Contact	Signal	Voltage	Core color <sup>1)</sup>
1	Tx +	GND <sub>S</sub>	yellow
2	Rx +	GND <sub>P</sub>	white
3	Rx -	U <sub>p</sub> : peripheral voltage, +24 V <sub>DC</sub>	blue
4	Tx -	U <sub>S</sub> : control voltage, +24 V <sub>DC</sub>	orange
Housing	Shield	Shield	Shield

<sup>1)</sup> The core colors apply to EtherCAT P cables and ECP cables from Beckhoff.



## 4.2.2 Status LEDs

### 4.2.2.1 Supply voltages



EtherCAT P Box modules indicate the status of the supply voltages via two status LEDs. The status LEDs are labeled with the designations of the supply voltages: U<sub>s</sub> and U<sub>p</sub>.

LED	Display	Meaning
U <sub>s</sub> (control voltage)	off	The supply voltage U <sub>s</sub> is not available.
	green illuminated	The supply voltage U <sub>s</sub> is available.
U <sub>p</sub> (peripheral voltage)	off	The supply voltage U <sub>p</sub> is not available.
	green illuminated	The supply voltage U <sub>p</sub> is available.

### 4.2.2.2 EtherCAT



#### L/A (Link/Act)

A green LED labeled "L/A" or "Link/Act" is located next to each EtherCAT/EtherCAT P socket. The LED indicates the communication state of the respective socket:

LED	Meaning
off	no connection to the connected EtherCAT device
lit	LINK: connection to the connected EtherCAT device
flashes	ACT: communication with the connected EtherCAT device

#### Run

Each EtherCAT slave has a green LED labelled "Run". The LED signals the status of the slave in the EtherCAT network:

LED	Meaning
off	Slave is in "Init" state
flashes uniformly	Slave is in "Pre-Operational" state
flashes sporadically	Slave is in "Safe-Operational" state
lit	Slave is in "Operational" state

Description of the EtherCAT slave states

### 4.2.3 Conductor losses

Take into account the voltage drop on the supply line when planning a system. Avoid the voltage drop being so high that the supply voltage at the box lies below the minimum nominal voltage. Variations in the voltage of the power supply unit must also be taken into account.

#### **i** Planning tool for EtherCAT P

You can plan cable lengths, voltages and currents of your EtherCAT P system using TwinCAT 3. The requirement for this is TwinCAT 3 Build 4020 or higher.

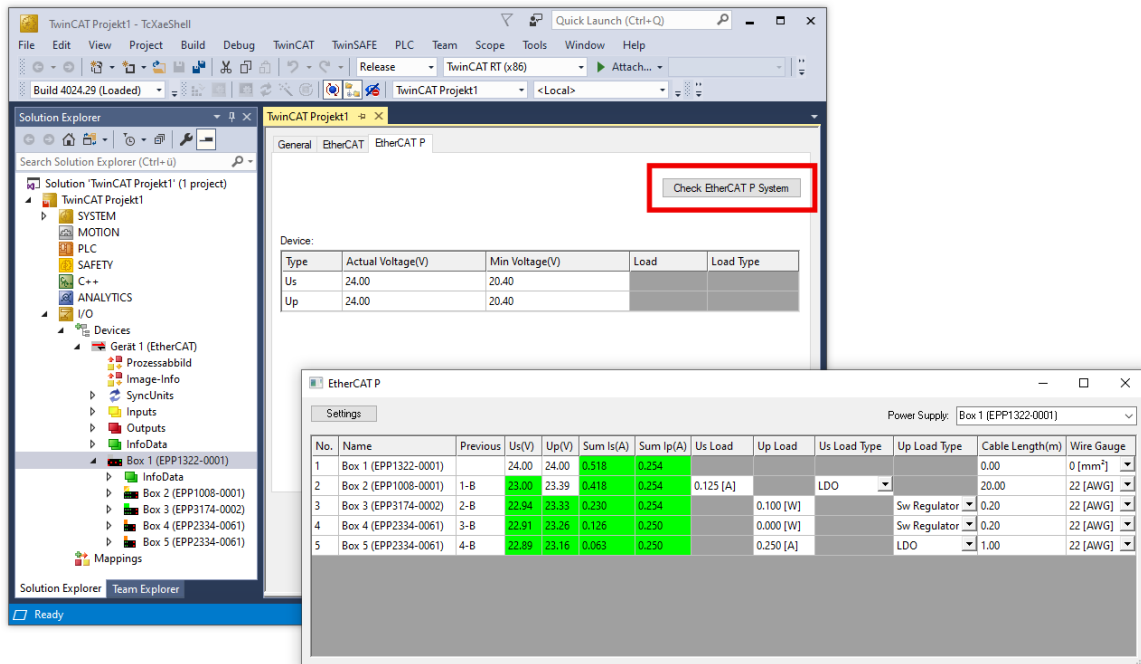

Further information can be found in the quick start guide [IO configuration in TwinCAT](#) in chapter "Configuration of EtherCAT P via TwinCAT".

#### Voltage drop on the supply line

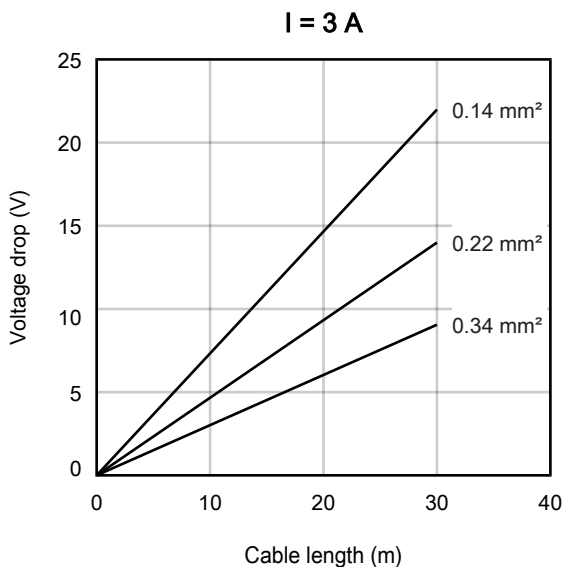

## 4.3 UL Requirements

The installation of the EtherCAT Box Modules certified by UL has to meet the following requirements.

### Supply voltage

#### ⚠ CAUTION

##### CAUTION!

This UL requirements are valid for all supply voltages of all marked EtherCAT Box Modules!  
For the compliance of the UL requirements the EtherCAT Box Modules should only be supplied

- by a 24 V<sub>DC</sub> supply voltage, supplied by an isolating source and protected by means of a fuse (in accordance with UL248), rated maximum 4 Amp, or
- by a 24 V<sub>DC</sub> power source, that has to satisfy *NEC class 2*.  
A *NEC class 2* power supply shall not be connected in series or parallel with another (class 2) power source!

#### ⚠ CAUTION

##### CAUTION!

To meet the UL requirements, the EtherCAT Box Modules must not be connected to unlimited power sources!

### Networks

#### ⚠ CAUTION

##### CAUTION!

To meet the UL requirements, EtherCAT Box Modules must not be connected to telecommunication networks!

### Ambient temperature range

#### ⚠ CAUTION

##### CAUTION!

To meet the UL requirements, EtherCAT Box Modules has to be operated only at an ambient temperature range of -25 °C to +55 °C!

### Marking for UL

All EtherCAT Box Modules certified by UL (Underwriters Laboratories) are marked with the following label.



Fig. 4: UL label

## 4.4 Disposal



Products marked with a crossed-out wheeled bin shall not be discarded with the normal waste stream. The device is considered as waste electrical and electronic equipment. The national regulations for the disposal of waste electrical and electronic equipment must be observed.

## **5 Commissioning/Configuration**

### **5.1 Integrating into a TwinCAT project**

The procedure for integration in a TwinCAT project is described in these [Quick start guide](#).

## 5.2 Acceleration sensors

The EPP3752-0000 has two accelerometers. Each accelerometer measures the acceleration in all three spatial directions.

The accelerometers are offset by 90°. This enables a plausibility check of the measured values.

The measured acceleration values can be converted to inclination angles: see chapter on [Inclination measurement](#) [► 27].

### Assignment of the acceleration axes to the process variables [► 12]

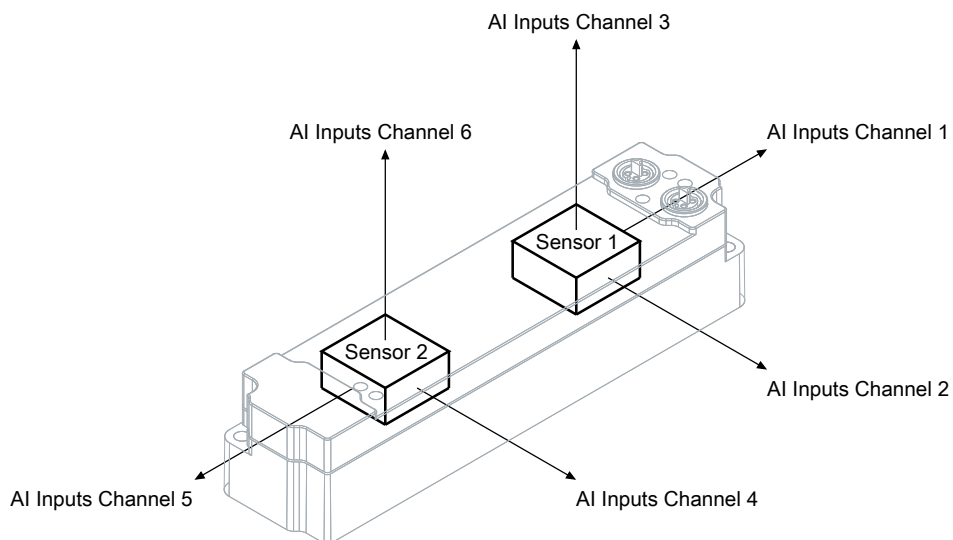

## 5.2.1 Settings

### 5.2.1.1 Measuring range

You can select the measuring range in the CoE parameter 0xF800:11 "Range".

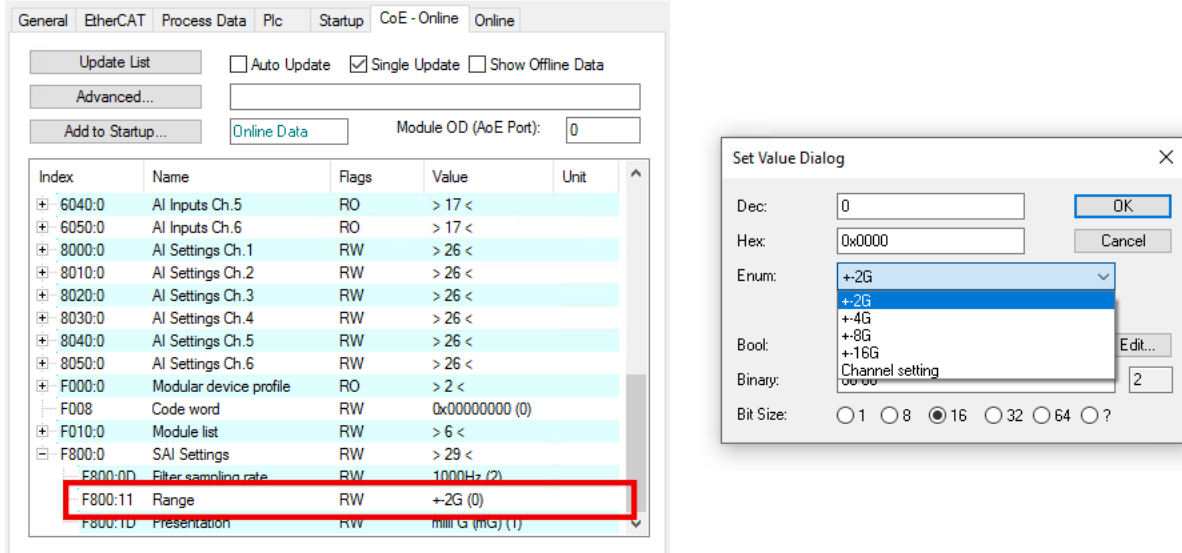

If you select the option "Channel setting", you can set the measuring range for each sensor individually:

- Measuring range for sensor 1: Index 0x8000:19 "Range"
- Measuring range for sensor 2: Index 0x8030:19 "Range"

This setting applies to all axes of the respective sensor. An individual setting for individual axes is not possible.

### 5.2.1.2 Scaling of the measured values

In the factory setting, the measured values are scaled to 1 mg / LSB. You can set the scaling of the measured values in CoE parameter F800:1D "Presentation".

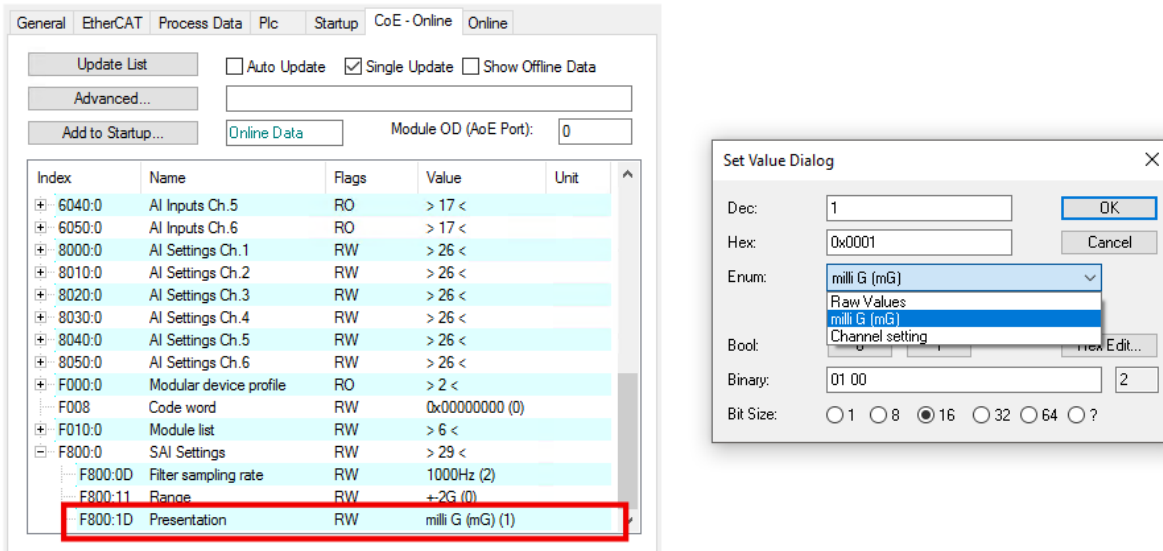

The following options are available:

Option	Description
"Raw Values"	The measured values of all acceleration axes are output without scaling as unprocessed raw values of the accelerometers.  The resolution of the raw values is not higher than the resolution of the measured values in mg. See diagram below.
"milli G (mG)" (default)	The measured values of all acceleration axes are scaled to 1 mg / LSB.
"Channel setting"	This option allows you to set the scaling of the measured values for each axis individually. Set the desired scaling in the CoE parameters 0x80n0:1A.

#### Transfer function

The following diagram shows the transfer function of the box.

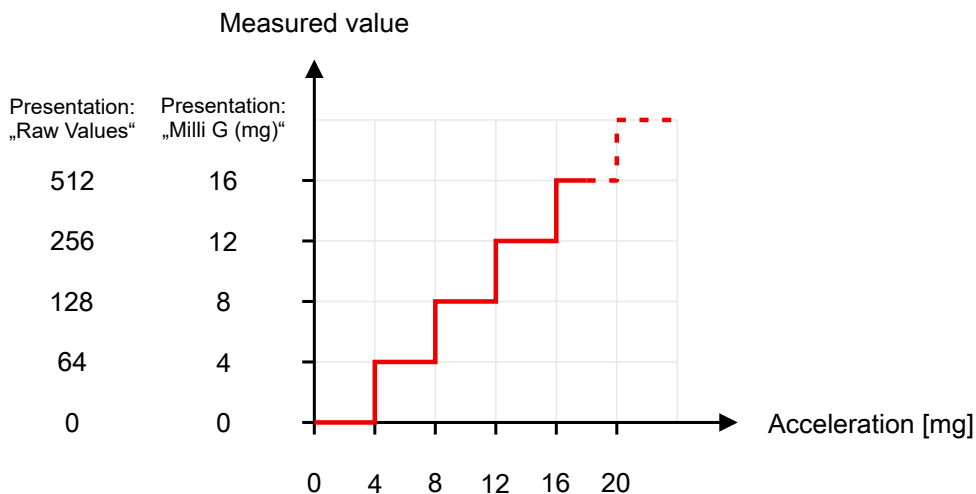

It can be seen that the resolution of the raw values is as high as the resolution of the measured values in mg.



### 5.2.1.3 Filter

#### Filter mode (FIR and IIR)

The EPP3752-0000 is equipped with digital filters which, depending on their settings, can adopt the characteristics of a *Finite Impulse Response filter (FIR filter)*, or of an *Infinite Impulse Response filter (IIR-Filter)*. The filters are deactivated by default. The activation takes place

- individually for each channel via the indices `0x80n0:06` [► 36] from Firmware 02.
- centrally via the 1<sup>st</sup> channel (index `0x8000:06` [► 36]) with Firmware 01.

The filter characteristic is selected individually for each channel via the indices `0x80n0:15` "Filter Settings":

#### FIR

The mean value of the last 32 measurements is calculated. The internal sampling rate (time interval between the individual measured values) can be parameterized via index `0xF800:0D` "Filter sampling rate".

#### IIR1...8

The filter with IIR characteristic can be set to one of 8 levels. The higher the level, the higher the attenuation of the present signal by the filter. The internal sampling rate can be set via index `0xF800:0D` "Filter sampling rate" (unlike other analog boxes in which a fixed cycle time of 1 ms is specified).

#### Setting of the internal sampling rate via index `0xF800:0D`

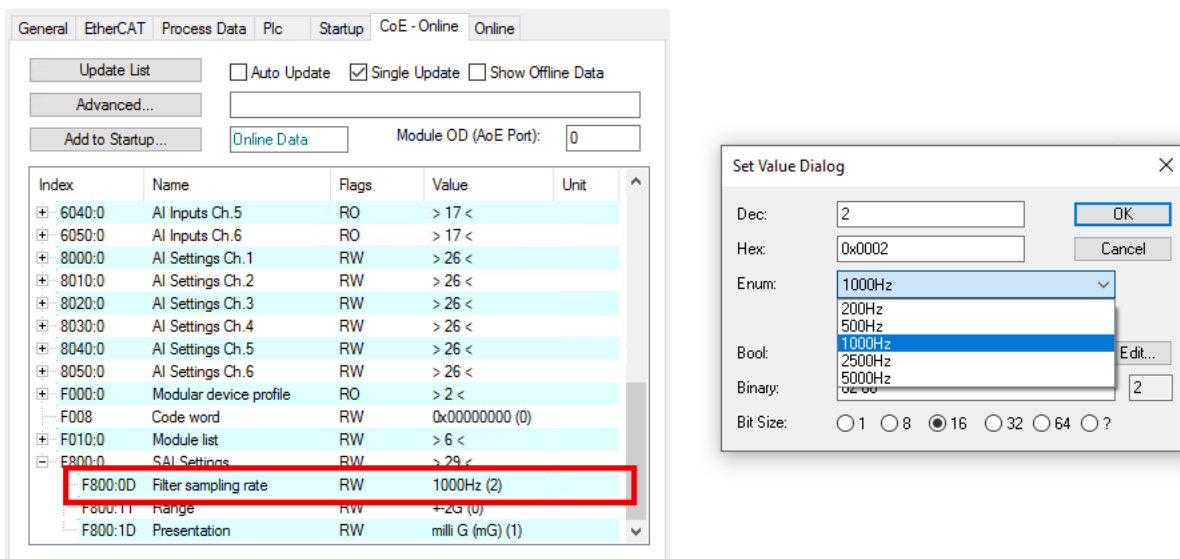

Fig. 5: Setting of the internal sampling rate (index `0xF800:0D`)

The internal sampling rate with filters switched on is set via the index `0xF800:0D`. On delivery this is set to 1000 Hz.

#### **i** Changing the update rate at 2000 Hz and 5000 Hz

The resolution is reduced to 8-bit if the rate is increased to 2500 Hz or 5000 Hz. This is necessary due to the sensors used.

#### 5.2.1.4 Sampling rate and synchronization

The sampling rate depends on whether the box's filters are activated. The filters are disabled by default. They are described in the chapter [Filter \[► 25\]](#).

- If all filters are disabled, the box works SM-synchron. In this mode the EtherCAT cycle time determines the sampling rate: in each EtherCAT cycle the measured values are read out from the sensors. The sensor operates internally with 10 bits up to a cycle time of 1 ms. Below this, the resolution drops to 8 bits. The minimum cycle time is 200  $\mu$ s.
- If at least one filter is enabled, the box runs in FreeRun mode with a sampling rate adjustable via CoE index 0xF800:0D "Filter sampling rate".  
If the sampling rate is increased to 2500 Hz or 5000 Hz, the resolution is reduced to 8-bit.

## 5.2.2 Inclination measurement

The calculation of an angle with higher resolution and accuracy should take place on a PC. The sensors used are capable of an accuracy of less than 0.1°.

Since the angle values are derived from the acceleration values, which are subject to certain noise, they have to be filtered via suitable algorithms.

In simple cases this could be a sliding average value, for example.

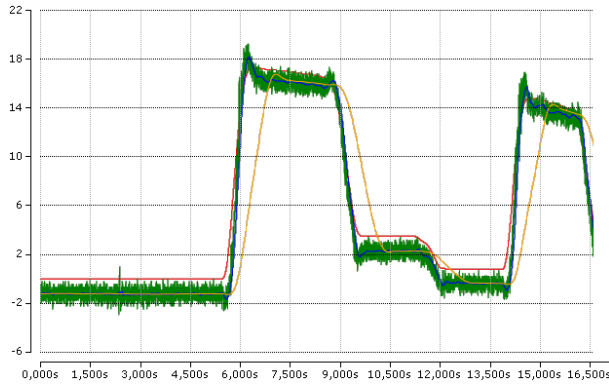

Fig. 6: Angle measurement, process data as acceleration values, calculation on a PC

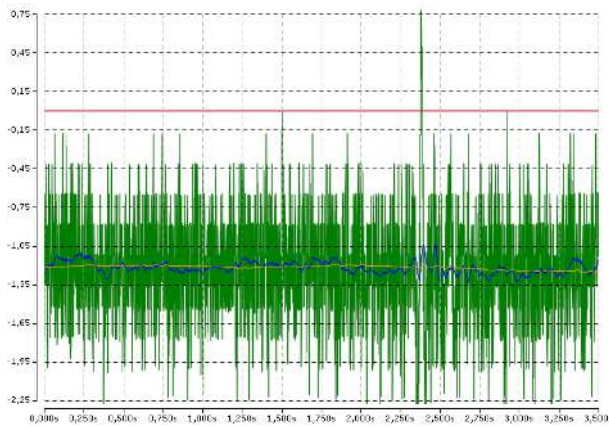
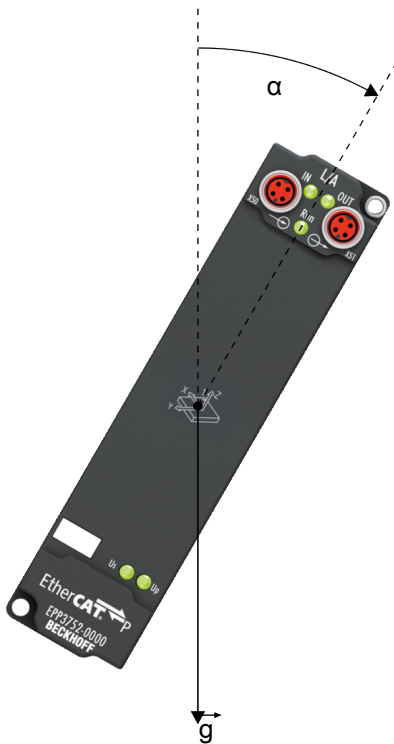

Fig. 7: Signal noise in detail

Color	Meaning
Red	Angle measured with 1024-step encoder / 4-way analysis for reference
Green	Angle trigonometrically calculated on a PC, without noise suppression
blue	Fast algorithm
yellow	Arithmetic mean (1000 sliding values)

## Sample



Equation for calculating the angle  $\alpha$ :

$$\alpha = \tan^{-1} \left( \frac{a_{y1}}{\sqrt{a_{x1}^2 + a_{z1}^2}} \right) \times \frac{360^\circ}{2\pi}$$

Implementation in TwinCAT:

```
alpha := ATAN(a_y1 / (SQRT(a_x1 * a_x1 + a_z1 * a_z1))) * 360 / (2*3.14);
```

## Sample Program

## NOTE

## Using the sample program

This document contains sample applications of our products for certain areas of application. The application notices provided here are based on typical features of our products and only serve as samples. The notices contained in this document explicitly do not refer to specific applications. The customer is therefore responsible for assessing and deciding whether the product is suitable for a particular application. We accept no responsibility for the completeness and correctness of the source code contained in this document. We reserve the right to modify the content of this document at any time and accept no responsibility for errors and missing information.

To download the sample program from this documentation please click on the following link:

 (<https://infosys.beckhoff.com/content/1033/epp3752-0000/Resources/3626380299/.zip>)

### 5.3 Restore the delivery state

You can restore the delivery state of the backup objects as follows:

1. Ensure that TwinCAT is running in Config mode.
2. In CoE object 1011:0 "Restore default parameters" select parameter 1011:01 "Subindex 001".

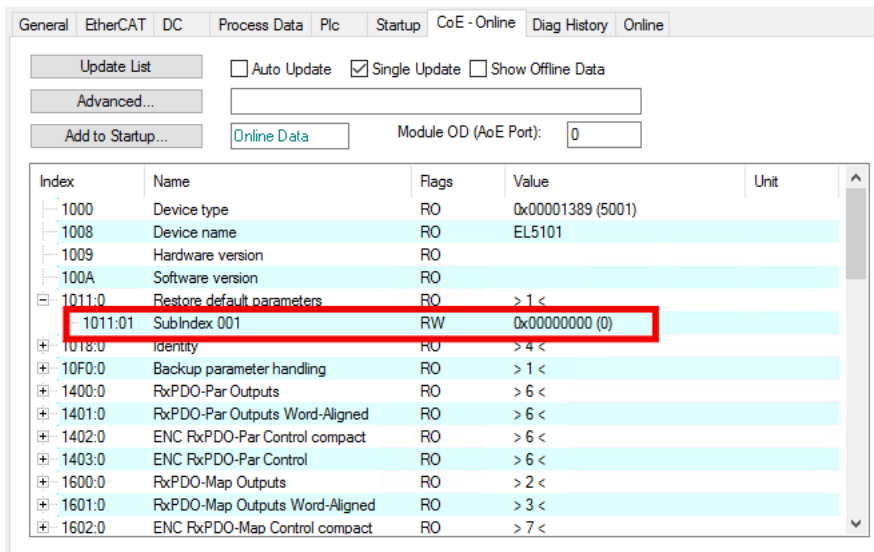

3. Double-click on "Subindex 001".  
⇒ The "Set Value Dialog" dialog box opens.
4. Enter the value 1684107116 in the "Dec" field.  
Alternatively: enter the value 0x64616F6C in the "Hex" field.

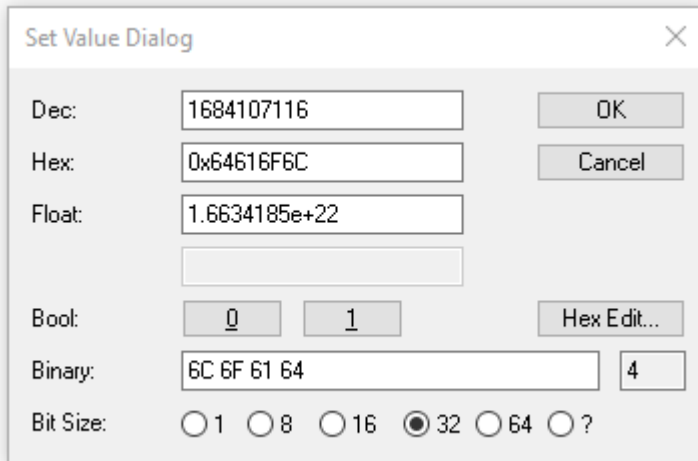

5. Confirm with "OK".  
⇒ All backup objects are reset to the delivery state.

#### **i** Alternative restore value

With some older modules the backup objects can be changed with an alternative restore value:  
 Decimal value: 1819238756  
 Hexadecimal value: 0x6C6F6164

An incorrect entry for the restore value has no effect.

## 5.4 Decommissioning

**⚠ WARNING****Risk of electric shock!**

Bring the bus system into a safe, de-energized state before starting disassembly of the devices!

## 6 CoE parameters

### 6.1 Object overview

---

#### **i** EtherCAT XML Device Description

The display matches that of the CoE objects from the EtherCAT XML Device Description. We recommend downloading the latest XML file from the download area of the Beckhoff website and installing it according to installation instructions.

---

Index (hex)	Name	Flags	Default value	
1000 [▶ 40]	Device type	RO	0x00001389 (5001 <sub>dec</sub> )	
1008 [▶ 40]	Device name	RO	EPP3752-0000	
1009 [▶ 40]	Hardware version	RO	00	
100A [▶ 40]	Software version	RO	00	
1011:0 [▶ 35]	<b>Subindex</b>	Restore default parameters	RO	0x01 (1 <sub>dec</sub> )
	1011:01	SubIndex 001	RW	0x00000000 (0 <sub>dec</sub> )
1018:0	<b>Subindex</b>	Identity	RO	0x04 (4 <sub>dec</sub> )
	1018:01	Vendor ID	RO	0x00000002 (2 <sub>dec</sub> )
	1018:02	Product code	RO	0x0EA84052 (245907538 <sub>dec</sub> )
	1018:03	Revision	RO	0x00100002 (1048578 <sub>dec</sub> )
	1018:04	Serial number	RO	0x00000000 (0 <sub>dec</sub> )
10F0:0 [▶ 40]	<b>Subindex</b>	Backup parameter handling	RO	0x01 (1 <sub>dec</sub> )
	10F0:01	Checksum	RO	0x00000000 (0 <sub>dec</sub> )
1A00:0 [▶ 41]	<b>Subindex</b>	AI TxPDO-Map Inputs Ch.1	RO	0x06 (6 <sub>dec</sub> )
	1A00:01	SubIndex 001	RO	0x0000:00, 6
	1A00:02	SubIndex 002	RO	0x6000:07, 1
	1A00:03	SubIndex 003	RO	0x0000:00, 7
	1A00:04	SubIndex 004	RO	0x6000:0F, 1
	1A00:05	SubIndex 005	RO	0x6000:10, 1
	1A00:06	SubIndex 006	RO	0x6000:11, 16
1A01:0 [▶ 41]	<b>Subindex</b>	AI TxPDO-Map Inputs Ch.2	RO	0x06 (6 <sub>dec</sub> )
	1A01:01	SubIndex 001	RO	0x0000:00, 6
	1A01:02	SubIndex 002	RO	0x6010:07, 1
	1A01:03	SubIndex 003	RO	0x0000:00, 7
	1A01:04	SubIndex 004	RO	0x6010:0F, 1
	1A01:05	SubIndex 005	RO	0x6010:10, 1
	1A01:06	SubIndex 006	RO	0x6010:11, 16
1A02:0 [▶ 41]	<b>Subindex</b>	AI TxPDO-Map Inputs Ch.3	RO	0x06 (6 <sub>dec</sub> )
	1A02:01	SubIndex 001	RO	0x0000:00, 6
	1A02:02	SubIndex 002	RO	0x6020:07, 1
	1A02:03	SubIndex 003	RO	0x0000:00, 7
	1A02:04	SubIndex 004	RO	0x6020:0F, 1
	1A02:05	SubIndex 005	RO	0x6020:10, 1
	1A02:06	SubIndex 006	RO	0x6020:11, 16
1A03:0 [▶ 41]	<b>Subindex</b>	AI TxPDO-Map Inputs Ch.4	RO	0x06 (6 <sub>dec</sub> )
	1A03:01	SubIndex 001	RO	0x0000:00, 6
	1A03:02	SubIndex 002	RO	0x6030:07, 1
	1A03:03	SubIndex 003	RO	0x0000:00, 7
	1A03:04	SubIndex 004	RO	0x6030:0F, 1
	1A03:05	SubIndex 005	RO	0x6030:10, 1
	1A03:06	SubIndex 006	RO	0x6030:11, 16
1A04:0 [▶ 42]	<b>Subindex</b>	AI TxPDO-Map Inputs Ch.5	RO	0x06 (6 <sub>dec</sub> )
	1A04:01	SubIndex 001	RO	0x0000:00, 6
	1A04:02	SubIndex 002	RO	0x6040:07, 1
	1A04:03	SubIndex 003	RO	0x0000:00, 7
	1A04:04	SubIndex 004	RO	0x6040:0F, 1
	1A04:05	SubIndex 005	RO	0x6040:10, 1
	1A04:06	SubIndex 006	RO	0x6040:11, 16



Index (hex)		Name	Flags	Default value
1A05:0 [▶ 42]	<b>Subindex</b>	AI TxPDO-Map Inputs Ch.6	RO	0x06 (6 <sub>dec</sub> )
	1A05:01	SubIndex 001	RO	0x0000:00, 6
	1A05:02	SubIndex 002	RO	0x6050:07, 1
	1A05:03	SubIndex 003	RO	0x0000:00, 7
	1A05:04	SubIndex 004	RO	0x6050:0F, 1
	1A05:05	SubIndex 005	RO	0x6040:10, 1
	1A05:06	SubIndex 006	RO	0x6050:11, 16
	1A05:02	AI TxPDO-Map Inputs Ch.5	RO	0x06 (6 <sub>dec</sub> )
1C00:0 [▶ 42]	<b>Subindex</b>	Sync manager type	RO	0x04 (4 <sub>dec</sub> )
	1C00:01	SubIndex 001	RO	0x01 (1 <sub>dec</sub> )
	1C00:02	SubIndex 002	RO	0x02 (2 <sub>dec</sub> )
	1C00:03	SubIndex 003	RO	0x03 (3 <sub>dec</sub> )
	1C00:04	SubIndex 004	RO	0x04 (4 <sub>dec</sub> )
1C12:0 [▶ 42]	<b>Subindex</b>	RxPDO assign	RW	0x00 (0 <sub>dec</sub> )
1C13:0 [▶ 42]	<b>Subindex</b>	TxPDO assign	RW	0x06 (6 <sub>dec</sub> )
	1C13:01	SubIndex 001	RW	0x1A00 (6656 <sub>dec</sub> )
	1C13:02	SubIndex 002	RW	0x1A02 (6658 <sub>dec</sub> )
	1C13:03	SubIndex 003	RW	0x1A03 (6659 <sub>dec</sub> )
	1C13:04	SubIndex 004	RW	0x1A04 (6660 <sub>dec</sub> )
	1C13:05	SubIndex 005	RW	0x1A05 (6661 <sub>dec</sub> )
	1C13:06	SubIndex 006	RW	0x1A06 (6662 <sub>dec</sub> )
1C33:0 [▶ 43]	<b>Subindex</b>	SM input parameter	RO	0x20 (32 <sub>dec</sub> )
	1C33:01	Sync mode	RW	0x0022 (34 <sub>dec</sub> )
	1C33:02	Cycle time	RW	0x000F4240 (1000000 <sub>dec</sub> )
	1C33:03	Shift time	RO	0x00000000 (0 <sub>dec</sub> )
	1C33:04	Sync modes supported	RO	0x0003 (3 <sub>dec</sub> )
	1C33:05	Minimum cycle time	RO	0x00030D40 (200000 <sub>dec</sub> )
	1C33:06	Calc and copy time	RO	0x00000000 (0 <sub>dec</sub> )
	1C33:07	Minimum delay time	RO	0x00000000 (0 <sub>dec</sub> )
	1C33:08	Command	RW	0x0000 (0 <sub>dec</sub> )
	1C33:09	Maximum Delay time	RO	0x00000000 (0 <sub>dec</sub> )
	1C33:0B	SM event missed counter	RO	0x0000 (0 <sub>dec</sub> )
	1C33:0C	Cycle exceeded counter	RO	0x0000 (0 <sub>dec</sub> )
	1C33:0D	Shift too short counter	RO	0x0000 (0 <sub>dec</sub> )
1C33:20	Sync error	RO	0x00 (0 <sub>dec</sub> )	
6000:0 [▶ 44]	<b>Subindex</b>	AI Inputs Ch.1	RO	0x11 (17 <sub>dec</sub> )
	6000:07	Error	RO	0x00 (0 <sub>dec</sub> )
	6000:0F	TxPDO State	RO	0x00 (0 <sub>dec</sub> )
	6000:10	TxPDO Toggle	RO	0x00 (0 <sub>dec</sub> )
	6000:11	Value	RO	0x0000 (0 <sub>dec</sub> )
6010:0 [▶ 44]	<b>Subindex</b>	AI Inputs Ch.2	RO	0x11 (17 <sub>dec</sub> )
	6010:07	Error	RO	0x00 (0 <sub>dec</sub> )
	6010:0F	TxPDO State	RO	0x00 (0 <sub>dec</sub> )
	6010:10	TxPDO Toggle	RO	0x00 (0 <sub>dec</sub> )
6020:0 [▶ 44]	<b>Subindex</b>	AI Inputs Ch.3	RO	0x11 (17 <sub>dec</sub> )
	6020:07	Error	RO	0x00 (0 <sub>dec</sub> )
	6020:0F	TxPDO State	RO	0x00 (0 <sub>dec</sub> )
	6020:10	TxPDO Toggle	RO	0x00 (0 <sub>dec</sub> )
6030:0 [▶ 44]	<b>Subindex</b>	AI Inputs Ch.4	RO	0x11 (17 <sub>dec</sub> )
	6030:07	Error	RO	0x00 (0 <sub>dec</sub> )
	6030:0F	TxPDO State	RO	0x00 (0 <sub>dec</sub> )
	6030:10	TxPDO Toggle	RO	0x00 (0 <sub>dec</sub> )
6040:0 [▶ 44]	<b>Subindex</b>	AI Inputs Ch.5	RO	0x11 (17 <sub>dec</sub> )
	6040:07	Error	RO	0x00 (0 <sub>dec</sub> )
	6040:0F	TxPDO State	RO	0x00 (0 <sub>dec</sub> )
	6040:10	TxPDO Toggle	RO	0x00 (0 <sub>dec</sub> )

Index (hex)	Name	Flags	Default value	
	6040:10	TxPDO Toggle	RO	0x00 (0 <sub>dec</sub> )
	6040:11	Value	RO	0x0000 (0 <sub>dec</sub> )
6050:0 [▶ 44]	<b>Subindex</b>	AI Inputs Ch.6	RO	0x11 (17 <sub>dec</sub> )
	6050:07	Error	RO	0x00 (0 <sub>dec</sub> )
	6050:0F	TxPDO State	RO	0x00 (0 <sub>dec</sub> )
	6050:10	TxPDO Toggle	RO	0x00 (0 <sub>dec</sub> )
	6050:11	Value	RO	0x0000 (0 <sub>dec</sub> )
8000:0 [▶ 36]	<b>Subindex</b>	AI Settings Ch.1	RW	0x1A (26 <sub>dec</sub> )
	8000:06	Enable filter	RW	0x00 (0 <sub>dec</sub> )
	8000:15	Filter settings	RW	0x0002 (2 <sub>dez</sub> )
	8000:19	Range	RW	0x0000 (0 <sub>dez</sub> )
	8000:1A	Presentation	RW	0x0001 (1 <sub>dez</sub> )
8010:0 [▶ 36]	<b>Subindex</b>	AI Settings Ch.2	RW	0x1A (26 <sub>dec</sub> )
	8010:06	Enable filter	RW	0x00 (0 <sub>dec</sub> )
	8010:15	Filter settings	RW	0x0002 (2 <sub>dez</sub> )
	8010:19	Range	RW	0x0000 (0 <sub>dez</sub> )
	8010:1A	Presentation	RW	0x0001 (1 <sub>dez</sub> )
8020:0 [▶ 37]	<b>Subindex</b>	AI Settings Ch.3	RW	0x1A (26 <sub>dec</sub> )
	8020:06	Enable filter	RW	0x00 (0 <sub>dec</sub> )
	8020:15	Filter settings	RW	0x0002 (2 <sub>dez</sub> )
	8020:19	Range	RW	0x0000 (0 <sub>dez</sub> )
	8020:1A	Presentation	RW	0x0001 (1 <sub>dez</sub> )
8030:0 [▶ 37]	<b>Subindex</b>	AI Settings Ch.4	RW	0x1A (26 <sub>dec</sub> )
	8030:06	Enable filter	RW	0x00 (0 <sub>dec</sub> )
	8030:15	Filter settings	RW	0x0002 (2 <sub>dez</sub> )
	8030:19	Range	RW	0x0000 (0 <sub>dez</sub> )
	8030:1A	Presentation	RW	0x0001 (1 <sub>dez</sub> )
8040:0 [▶ 38]	<b>Subindex</b>	AI Settings Ch.5	RW	0x1A (26 <sub>dec</sub> )
	8040:06	Enable filter	RW	0x00 (0 <sub>dec</sub> )
	8040:15	Filter settings	RW	0x0002 (2 <sub>dez</sub> )
	8040:19	Range	RW	0x0000 (0 <sub>dez</sub> )
	8040:1A	Presentation	RW	0x0001 (1 <sub>dez</sub> )
8050:0 [▶ 38]	<b>Subindex</b>	AI Settings Ch.6	RW	0x1A (26 <sub>dec</sub> )
	8050:06	Enable filter	RW	0x00 (0 <sub>dec</sub> )
	8050:15	Filter settings	RW	0x0002 (2 <sub>dez</sub> )
	8050:19	Range	RW	0x0000 (0 <sub>dez</sub> )
	8050:1A	Presentation	RW	0x0001 (1 <sub>dez</sub> )
8060:0 [▶ 39] (FW01)	<b>Subindex</b>	SAI Settings	RW	0x1D (29 <sub>dec</sub> )
	8060:0D	Filter sampling rate	RW	0x0002 (2 <sub>dez</sub> )
	8060:11	Range	RW	0x0000 (0 <sub>dez</sub> )
	8060:1D	Presentation	RW	0x0001 (1 <sub>dez</sub> )
F000:0 [▶ 45]	<b>Subindex</b>	Modular device profile	RO	0x02 (2 <sub>dec</sub> )
	F000:01	Module index distance	RO	0x0010 (16 <sub>dec</sub> )
	F000:02	Maximum number of modules	RO	0x0002 (2 <sub>dec</sub> )
F008 [▶ 45]		Code word	RW	0x00000000 (0 <sub>dec</sub> )
F010:0 [▶ 45]	<b>Subindex</b>	Module list	RW	0x02 (2 <sub>dec</sub> )
	F010:01	SubIndex 001	RW	0x00000258 (600 <sub>dec</sub> )
	F010:02	SubIndex 002	RW	0x00000258 (600 <sub>dec</sub> )
F800:0 [▶ 39] (from FW02)	<b>Subindex</b>	SAI Settings	RW	0x1D (29 <sub>dec</sub> )
	F800:0D	Filter sampling rate	RW	0x0002 (2 <sub>dez</sub> )
	F800:11	Range	RW	0x0000 (0 <sub>dec</sub> )
	F800:1D	Presentation	RW	0x0001 (1 <sub>dec</sub> )

## Key

Flags:

RO (Read Only): This object can only be read.  
 RW (Read/Write): This object can be read and written to.

## 6.2 Object description and parameterization

### ● EtherCAT XML Device Description

**i** The display matches that of the CoE objects from the EtherCAT XML Device Description. We recommend downloading the latest XML file from the download area of the Beckhoff website and installing it according to installation instructions.

### ● Parameterization via the CoE list (CAN over EtherCAT)

**i** The EtherCAT device is parameterized via the CoE - Online tab (double-click on the respective object) or via the Process Data tab (allocation of PDOs).

### Introduction

The CoE overview contains objects for different intended applications:

- [Objects required for parameterization \[▶ 35\]](#) during commissioning
- [Objects for indicating internal settings \[▶ 40\]](#) (may be fixed)
- Further [profile-specific objects \[▶ 44\]](#) indicating inputs, outputs and status information

The following section first describes the objects required for normal operation, followed by a complete overview of missing objects.

### Objects to be parameterized during commissioning

#### Index 1011 Restore default parameters

Index (hex)	Name	Meaning	Data type	Flags	Default
1011:0	Restore default parameters	Restore default settings	UINT8	RO	0x01 (1 <sub>dec</sub> )
1011:01	SubIndex 001	If this object is set to <b>"0x64616F6C"</b> in the Set Value Dialog, all backup objects are reset to their delivery state.	UINT32	RW	0x00000000 (0 <sub>dec</sub> )

## Index 8000 AI Settings Ch.1

Index (hex)	Name	Meaning	Data type	Flags	Default	
8000:0	AI Settings Ch.1		UINT8	RO	0x1A (26 <sub>dec</sub> )	
8000:06	Enable filter	Activates the filter.	BOOLEAN	RW	0x00 (0 <sub>dec</sub> )	
8000:15	Filter settings	This object determines the filter settings of all channels of the module when it is activated via <i>Enable filter</i> index 0x80n0:06.	UINT16	RW	0x0002 (2 <sub>dec</sub> )	
		0				FIR
		2				IIR1
		3				IIR2
		4				IIR3
		5				IIR4
		6				IIR5
		7				IIR6
		8				IIR7
		9				IIR8
8000:19	Range	Setting the measuring range: <ul style="list-style-type: none"> <li>• 0<sub>dec</sub>: +-2G</li> <li>• 1<sub>dec</sub>: +-4G</li> <li>• 2<sub>dec</sub>: +-8G</li> <li>• 3<sub>dec</sub>: +-16G</li> </ul>	UINT16	RW	0x0000 (0 <sub>dec</sub> )	
8000:1A	Presentation	Representation of the data <ul style="list-style-type: none"> <li>• 0<sub>dec</sub>: Raw values</li> <li>• 1<sub>dec</sub>: milli G (mG)</li> </ul>	UINT16	RW	0x0001 (1 <sub>dec</sub> )	

## Index 8010 AI Settings Ch.2

Index (hex)	Name	Meaning	Data type	Flags	Default	
8010:0	AI Settings Ch.2		UINT8	RO	0x1A (26 <sub>dec</sub> )	
8010:06	Enable filter	Activates the filter.	BOOLEAN	RW	0x00 (0 <sub>dec</sub> )	
8010:15	Filter settings	This object determines the filter settings of all channels of the module when it is activated via <i>Enable filter</i> index 0x80n0:06.	UINT16	RW	0x0002 (2 <sub>dec</sub> )	
		0				FIR
		2				IIR1
		3				IIR2
		4				IIR3
		5				IIR4
		6				IIR5
		7				IIR6
		8				IIR7
		9				IIR8
8010:19	Range	Setting the measuring range: <ul style="list-style-type: none"> <li>• 0<sub>dec</sub>: +-2G</li> <li>• 1<sub>dec</sub>: +-4G</li> <li>• 2<sub>dec</sub>: +-8G</li> <li>• 3<sub>dec</sub>: +-16G</li> </ul>	UINT16	RW	0x0000 (0 <sub>dec</sub> )	
8010:1A	Presentation	Representation of the data <ul style="list-style-type: none"> <li>• 0<sub>dec</sub>: Raw values</li> <li>• 1<sub>dec</sub>: milli G (mG)</li> </ul>	UINT16	RW	0x0001 (1 <sub>dec</sub> )	

**Index 8020 AI Settings Ch.3**

Index (hex)	Name	Meaning	Data type	Flags	Default	
8020:0	AI Settings Ch.3		UINT8	RO	0x1A (26 <sub>dec</sub> )	
8020:06	Enable filter	Activates the filter.	BOOLEAN	RW	0x00 (0 <sub>dec</sub> )	
8020:15	Filter settings	This object determines the filter settings of all channels of the module when it is activated via <i>Enable filter</i> index 0x80n0:06.	UINT16	RW	0x0002 (2 <sub>dec</sub> )	
		0				FIR
		2				IIR1
		3				IIR2
		4				IIR3
		5				IIR4
		6				IIR5
		7				IIR6
		8				IIR7
		9				IIR8
8020:19	Range	Setting the measuring range: <ul style="list-style-type: none"> <li>• 0<sub>dec</sub>: +-2G</li> <li>• 1<sub>dec</sub>: +-4G</li> <li>• 2<sub>dec</sub>: +-8G</li> <li>• 3<sub>dec</sub>: +-16G</li> </ul>	UINT16	RW	0x0000 (0 <sub>dec</sub> )	
8020:1A	Presentation	Representation of the data <ul style="list-style-type: none"> <li>• 0<sub>dec</sub>: Raw values</li> <li>• 1<sub>dec</sub>: milli G (mG)</li> </ul>	UINT16	RW	0x0001 (1 <sub>dec</sub> )	

**Index 8030 AI Settings Ch.4**

Index (hex)	Name	Meaning	Data type	Flags	Default	
8030:0	AI Settings Ch.4		UINT8	RO	0x11 (21 <sub>dec</sub> )	
8030:06	Enable filter	Activates the filter.	BOOLEAN	RW	0x00 (0 <sub>dec</sub> )	
8030:15	Filter settings	This object determines the filter settings of all channels of the module when it is activated via <i>Enable filter</i> index 0x80n0:06.	UINT16	RW	0x0002 (2 <sub>dec</sub> )	
		0				FIR
		2				IIR1
		3				IIR2
		4				IIR3
		5				IIR4
		6				IIR5
		7				IIR6
		8				IIR7
		9				IIR8
8030:19	Range	Setting the measuring range: <ul style="list-style-type: none"> <li>• 0<sub>dec</sub>: +-2G</li> <li>• 1<sub>dec</sub>: +-4G</li> <li>• 2<sub>dec</sub>: +-8G</li> <li>• 3<sub>dec</sub>: +-16G</li> </ul>	UINT16	RW	0x0000 (0 <sub>dec</sub> )	
8030:1A	Presentation	Representation of the data <ul style="list-style-type: none"> <li>• 0<sub>dec</sub>: Raw values</li> <li>• 1<sub>dec</sub>: milli G (mG)</li> </ul>	UINT16	RW	0x0001 (1 <sub>dec</sub> )	

## Index 8040 AI Settings Ch.5

Index (hex)	Name	Meaning	Data type	Flags	Default	
8040:0	AI Settings Ch.5		UINT8	RO	0x1A (26 <sub>dec</sub> )	
8040:06	Enable filter	Activates the filter.	BOOLEAN	RW	0x00 (0 <sub>dec</sub> )	
8040:15	Filter settings	This object determines the filter settings of all channels of the module when it is activated via <i>Enable filter</i> index 0x80n0:06.	UINT16	RW	0x0002 (2 <sub>dec</sub> )	
		0				FIR
		2				IIR1
		3				IIR2
		4				IIR3
		5				IIR4
		6				IIR5
		7				IIR6
		8				IIR7
		9				IIR8
8040:19	Range	Setting the measuring range: <ul style="list-style-type: none"> <li>• 0<sub>dec</sub>: +-2G</li> <li>• 1<sub>dec</sub>: +-4G</li> <li>• 2<sub>dec</sub>: +-8G</li> <li>• 3<sub>dec</sub>: +-16G</li> </ul>	UINT16	RW	0x0000 (0 <sub>dec</sub> )	
8040:1A	Presentation	Representation of the data <ul style="list-style-type: none"> <li>• 0<sub>dec</sub>: Raw values</li> <li>• 1<sub>dec</sub>: milli G (mG)</li> </ul>	UINT16	RW	0x0001 (1 <sub>dec</sub> )	

## Index 8050 AI Settings Ch.6

Index (hex)	Name	Meaning	Data type	Flags	Default	
8050:0	AI Settings Ch.6		UINT8	RO	0x1A (26 <sub>dec</sub> )	
8050:06	Enable filter	Activates the filter.	BOOLEAN	RW	0x00 (0 <sub>dec</sub> )	
8050:15	Filter settings	This object determines the filter settings of all channels of the module when it is activated via <i>Enable filter</i> index 0x80n0:06.	UINT16	RW	0x0002 (2 <sub>dec</sub> )	
		0				FIR
		2				IIR1
		3				IIR2
		4				IIR3
		5				IIR4
		6				IIR5
		7				IIR6
		8				IIR7
		9				IIR8
8050:19	Range	Setting the measuring range: <ul style="list-style-type: none"> <li>• 0<sub>dec</sub>: +-2G</li> <li>• 1<sub>dec</sub>: +-4G</li> <li>• 2<sub>dec</sub>: +-8G</li> <li>• 3<sub>dec</sub>: +-16G</li> </ul>	UINT16	RW	0x0000 (0 <sub>dec</sub> )	
8050:1A	Presentation	Representation of the data <ul style="list-style-type: none"> <li>• 0<sub>dec</sub>: Raw values</li> <li>• 1<sub>dec</sub>: milli G (mG)</li> </ul>	UINT16	RW	0x0001 (1 <sub>dec</sub> )	

**Index 8060 SAI Settings (Firmware 01)**

The object with index 8060 is invisible in the object directory from Firmware 02. However, it can still be read and written via SDO access. This ensures backward compatibility with PLC programs that were written prior to the release of Firmware 02.

The content of index 8060 is mirrored in [index F800 \[▶ 39\]](#) from Firmware 02.

Index (hex)	Name	Meaning	Data type	Flags	Default
8060:0	SAI Settings		UINT8	RO	0x1D (29 <sub>dec</sub> )
8060:0D	Filter sampling rate	Selection of the internal sampling rate: <ul style="list-style-type: none"> <li>• 0<sub>dec</sub>: 200 Hz</li> <li>• 1<sub>dec</sub>: 500 Hz</li> <li>• 2<sub>dec</sub>: 1000 Hz</li> <li>• 3<sub>dec</sub>: 2500 Hz</li> <li>• 4<sub>dec</sub>: 5000 Hz</li> <li>• The sensor resolution is reduced to 8-bit if the rate is increased to 2500 Hz or 5000 Hz.</li> </ul>	UINT16	RW	0x0002 (2 <sub>dec</sub> )
8060:11	Range	Setting the measuring range: <ul style="list-style-type: none"> <li>• 0<sub>dec</sub>: +-2G</li> <li>• 1<sub>dec</sub>: +-4G</li> <li>• 2<sub>dec</sub>: +-8G</li> <li>• 3<sub>dec</sub>: +-16G</li> </ul>	UINT16	RW	0x0000 (0 <sub>dec</sub> )
8060:1D	Presentation	Representation of the data <ul style="list-style-type: none"> <li>• 0<sub>dec</sub>: Raw values</li> <li>• 1<sub>dec</sub>: milli G (mG)</li> </ul>	UINT16	RW	0x0001 (1 <sub>dec</sub> )

**Index F800 SAI Settings (from Firmware 02)**

Index (hex)	Name	Meaning	Data type	Flags	Default
F800:0	SAI Settings		UINT8	RO	0x1D (29 <sub>dec</sub> )
F800:0D	Filter sampling rate	Selection of the internal sampling rate: <ul style="list-style-type: none"> <li>• 0<sub>dec</sub>: 200 Hz</li> <li>• 1<sub>dec</sub>: 500 Hz</li> <li>• 2<sub>dec</sub>: 1000 Hz</li> <li>• 3<sub>dec</sub>: 2500 Hz</li> <li>• 4<sub>dec</sub>: 5000 Hz</li> <li>• The sensor resolution is reduced to 8-bit if the rate is increased to 2500 Hz or 5000 Hz.</li> </ul>	UINT16	RW	0x0002 (2 <sub>dec</sub> )
F800:11	Range	Setting the measuring range: <ul style="list-style-type: none"> <li>• 0<sub>dec</sub>: +-2G</li> <li>• 1<sub>dec</sub>: +-4G</li> <li>• 2<sub>dec</sub>: +-8G</li> <li>• 3<sub>dec</sub>: +-16G</li> <li>• 255<sub>dec</sub>: Channel setting: The measuring range is set individually for each channel via the indices 0x80n0:19.</li> </ul>	UINT16	RW	0x0000 (0 <sub>dec</sub> )
F800:1D	Presentation	Representation of the data <ul style="list-style-type: none"> <li>• 0<sub>dec</sub>: Raw values</li> <li>• 1<sub>dec</sub>: milli G (mG)</li> <li>• 255<sub>dec</sub>: Channel setting: The representation is set channel-wise via the indices 0x80n0:1A.</li> </ul>	UINT16	RW	0x0001 (1 <sub>dec</sub> )

## Additional objects

### Standard objects (0x1000-0x1FFF)

The standard objects have the same meaning for all EtherCAT slaves.

#### Index 1000 Device type

Index (hex)	Name	Meaning	Data type	Flags	Default
1000:0	Device type	Device type of the EtherCAT slave: The Lo-Word contains the CoE profile used (5001). The Hi-Word contains the module profile according to the modular device profile.	UINT32	RO	0x00001389 (5001 <sub>dec</sub> )

#### Index 1008 Device name

Index (hex)	Name	Meaning	Data type	Flags	Default
1008:0	Device name	Device name of the EtherCAT slave	STRING	RO	EP3752-0000

#### Index 1009 Hardware version

Index (hex)	Name	Meaning	Data type	Flags	Default
1009:0	Hardware version	Hardware version of the EtherCAT slave	STRING	RO	00

#### Index 100A Software Version

Index (hex)	Name	Meaning	Data type	Flags	Default
100A:0	Software version	Firmware version of the EtherCAT slave	STRING	RO	00

#### Index 1018 Identity

Index (hex)	Name	Meaning	Data type	Flags	Default
1018:0	Identity	Information for identifying the slave	UINT8	RO	0x04 (4 <sub>dec</sub> )
1018:01	Vendor ID	Vendor ID of the EtherCAT slave	UINT32	RO	0x00000002 (2 <sub>dec</sub> )
1018:02	Product code	Product code of the EtherCAT slave	UINT32	RO	0x6476b088 (1685500040 <sub>dec</sub> )
1018:03	Revision	Revision number of the EtherCAT slave; the Low Word (bit 0-15) indicates the special terminal number, the High Word (bit 16-31) refers to the device description	UINT32	RO	0x00100002 (1048578 <sub>dec</sub> )
1018:04	Serial number	Serial number of the EtherCAT slave; the Low Byte (bit 0-7) of the Low Word contains the year of production, the High Byte (bit 8-15) of the Low Word contains the week of production, the High Word (bit 16-31) is 0	UINT32	RO	0x00000000 (0 <sub>dec</sub> )

#### Index 10F0 Backup parameter handling

Index (hex)	Name	Meaning	Data type	Flags	Default
10F0:0	Backup parameter handling	Information for standardized loading and saving of backup entries	UINT8	RO	0x01 (1 <sub>dec</sub> )
10F0:01	Checksum	Checksum across all backup entries of the EtherCAT slave	UINT32	RO	0x00000000 (0 <sub>dec</sub> )



**Index 1A00 AI TxPDO-Map Inputs Ch.1**

Index (hex)	Name	Meaning	Data type	Flags	Default
1A00:0	AI TxPDO-Map Inputs Ch.1	PDO Mapping TxPDO 1	UINT8	RO	0x06 (6 <sub>dec</sub> )
1A00:01	SubIndex 001	1. PDO Mapping entry (6 bit align)	UINT32	RO	0x0000:00, 6
1A00:02	SubIndex 002	2. PDO Mapping entry (object 0x6000 (AI Inputs Ch.1), entry 0x07 (Error))	UINT32	RO	0x6000:07, 1
1A00:03	SubIndex 003	3. PDO Mapping entry (7 bit align)	UINT32	RO	0x0000:00, 7
1A00:04	SubIndex 004	4. PDO Mapping entry (object 0x6000 (AI Inputs Ch.1), entry 0x0F (TxPDO State))	UINT32	RO	0x6000:0F, 1
1A00:05	SubIndex 005	5. PDO Mapping entry (object 0x6000 (AI Inputs Ch.1), entry 0x10 (TxPDO Toggle))	UINT32	RO	0x6000:10, 1
1A00:06	SubIndex 006	6. PDO Mapping entry (object 0x6000 (AI Inputs Ch.1), entry 0x11 (Value))	UINT32	RO	0x6000:11, 16

**Index 1A01 AI TxPDO-Map Inputs Ch.2**

Index (hex)	Name	Meaning	Data type	Flags	Default
1A01:0	AI TxPDO-Map Inputs Ch.1	PDO Mapping TxPDO 2	UINT8	RO	0x06 (6 <sub>dec</sub> )
1A01:01	SubIndex 001	1. PDO Mapping entry (6 bit align)	UINT32	RO	0x0000:00, 6
1A01:02	SubIndex 002	2. PDO Mapping entry (object 0x6010 (AI Inputs Ch.2), entry 0x07 (Error))	UINT32	RO	0x6010:07, 1
1A01:03	SubIndex 003	3. PDO Mapping entry (7 bit align)	UINT32	RO	0x0010:00, 7
1A01:04	SubIndex 004	4. PDO Mapping entry (object 0x6010 (AI Inputs Ch.2), entry 0x0F (TxPDO State))	UINT32	RO	0x6010:0F, 1
1A01:05	SubIndex 005	5. PDO Mapping entry (object 0x6010 (AI Inputs Ch.2), entry 0x10 (TxPDO Toggle))	UINT32	RO	0x6010:10, 1
1A01:06	SubIndex 006	6. PDO Mapping entry (object 0x6010 (AI Inputs Ch.2), entry 0x11 (Value))	UINT32	RO	0x6010:11, 16

**Index 1A02 AI TxPDO-Map Inputs Ch.3**

Index (hex)	Name	Meaning	Data type	Flags	Default
1A02:0	AI TxPDO-Map Inputs Ch.3	PDO Mapping TxPDO 3	UINT8	RO	0x06 (6 <sub>dec</sub> )
1A02:01	SubIndex 001	1. PDO Mapping entry (6 bit align)	UINT32	RO	0x0000:00, 6
1A02:02	SubIndex 002	2. PDO Mapping entry (object 0x6020 (AI Inputs Ch.3), entry 0x07 (Error))	UINT32	RO	0x6020:07, 1
1A02:03	SubIndex 003	3. PDO Mapping entry (7 bit align)	UINT32	RO	0x0000:00, 7
1A02:04	SubIndex 004	4. PDO Mapping entry (object 0x6020 (AI Inputs Ch.3), entry 0x0F (TxPDO State))	UINT32	RO	0x6020:0F, 1
1A02:05	SubIndex 005	5. PDO Mapping entry (object 0x6020 (AI Inputs Ch.3), entry 0x10 (TxPDO Toggle))	UINT32	RO	0x6020:10, 1
1A02:06	SubIndex 006	6. PDO Mapping entry (object 0x6020 (AI Inputs Ch.3), entry 0x11 (Value))	UINT32	RO	0x6020:11, 16

**Index 1A03 AI TxPDO-Map Inputs Ch.4**

Index (hex)	Name	Meaning	Data type	Flags	Default
1A03:0	AI TxPDO-Map Inputs Ch.4	PDO Mapping TxPDO 4	UINT8	RO	0x06 (6 <sub>dec</sub> )
1A03:01	SubIndex 001	1. PDO Mapping entry (6 bit align)	UINT32	RO	0x0000:00, 6
1A03:02	SubIndex 002	2. PDO Mapping entry (object 0x6030 (AI Inputs Ch.4), entry 0x07 (Error))	UINT32	RO	0x6030:07, 1
1A03:03	SubIndex 003	3. PDO Mapping entry (7 bit align)	UINT32	RO	0x0000:00, 7
1A03:04	SubIndex 004	4. PDO Mapping entry (object 0x6030 (AI Inputs Ch.4), entry 0x0F (TxPDO State))	UINT32	RO	0x6030:0F, 1
1A03:05	SubIndex 005	5. PDO Mapping entry (object 0x6030 (AI Inputs Ch.4), entry 0x10 (TxPDO Toggle))	UINT32	RO	0x6030:10, 1
1A03:06	SubIndex 006	6. PDO Mapping entry (object 0x6030 (AI Inputs Ch.4), entry 0x11 (Value))	UINT32	RO	0x6030:11, 16

**Index 1A04 AI TxPDO-Map Inputs Ch.5**

Index (hex)	Name	Meaning	Data type	Flags	Default
1A04:0	AI TxPDO-Map Inputs Ch.5	PDO Mapping TxPDO 5	UINT8	RO	0x06 (6 <sub>dec</sub> )
1A04:01	SubIndex 001	1. PDO Mapping entry (6 bit align)	UINT32	RO	0x0000:00, 6
1A04:02	SubIndex 002	2. PDO Mapping entry (object 0x6040 (AI Inputs Ch.5), entry 0x07 (Error))	UINT32	RO	0x6040:07, 1
1A04:03	SubIndex 003	3. PDO Mapping entry (7 bit align)	UINT32	RO	0x0000:00, 7
1A04:04	SubIndex 004	4. PDO Mapping entry (object 0x6040 (AI Inputs Ch.5), entry 0x0F (TxPDO State))	UINT32	RO	0x6040:0F, 1
1A04:05	SubIndex 005	5. PDO Mapping entry (object 0x6040 (AI Inputs Ch.5), entry 0x10 (TxPDO Toggle))	UINT32	RO	0x6040:10, 1
1A04:06	SubIndex 006	6. PDO Mapping entry (object 0x6040 (AI Inputs Ch.5), entry 0x11 (Value))	UINT32	RO	0x6040:11, 16

**Index 1A05 AI TxPDO-Map Inputs Ch.6**

Index (hex)	Name	Meaning	Data type	Flags	Default
1A05:0	AI TxPDO-Map Inputs Ch.6	PDO Mapping TxPDO 5	UINT8	RO	0x06 (6 <sub>dec</sub> )
1A05:01	SubIndex 001	1. PDO Mapping entry (6 bit align)	UINT32	RO	0x0000:00, 6
1A05:02	SubIndex 002	2. PDO Mapping entry (object 0x6050 (AI Inputs Ch.6), entry 0x07 (Error))	UINT32	RO	0x6050:07, 1
1A05:03	SubIndex 003	3. PDO Mapping entry (7 bit align)	UINT32	RO	0x0000:00, 7
1A05:04	SubIndex 004	4. PDO Mapping entry (object 0x6050 (AI Inputs Ch.6), entry 0x0F (TxPDO State))	UINT32	RO	0x6050:0F, 1
1A05:05	SubIndex 005	5. PDO Mapping entry (object 0x6050 (AI Inputs Ch.6), entry 0x10 (TxPDO Toggle))	UINT32	RO	0x6050:10, 1
1A05:06	SubIndex 006	6. PDO Mapping entry (object 0x6050 (AI Inputs Ch.6), entry 0x11 (Value))	UINT32	RO	0x6050:11, 16

**Index 1C00 Sync manager type**

Index (hex)	Name	Meaning	Data type	Flags	Default
1C00:0	Sync manager type	Using the Sync Managers	UINT8	RO	0x04 (4 <sub>dec</sub> )
1C00:01	SubIndex 001	Sync-Manager Type Channel 1: Mailbox Write	UINT8	RO	0x01 (1 <sub>dec</sub> )
1C00:02	SubIndex 002	Sync-Manager Type Channel 2: Mailbox Read	UINT8	RO	0x02 (2 <sub>dec</sub> )
1C00:03	SubIndex 003	Sync-Manager Type Channel 3: Process Data Write (Outputs)	UINT8	RO	0x03 (3 <sub>dec</sub> )
1C00:04	SubIndex 004	Sync-Manager Type Channel 4: Process Data Read (Inputs)	UINT8	RO	0x04 (4 <sub>dec</sub> )

**Index 1C12 RxPDO assign**

Index (hex)	Name	Meaning	Data type	Flags	Default
1C12:0	RxPDO assign	PDO Assign Outputs	UINT8	RW	0x00 (0 <sub>dec</sub> )

**Index 1C13 TxPDO assign**

Index (hex)	Name	Meaning	Data type	Flags	Default
1C13:0	TxPDO assign	PDO Assign Inputs	UINT8	RW	0x04 (4 <sub>dec</sub> )
1C13:01	Subindex 001	1. allocated TxPDO (contains the index of the associated TxPDO mapping object)	UINT16	RW	0x1A00 (6656 <sub>dec</sub> )
1C13:02	Subindex 002	2. allocated TxPDO (contains the index of the associated TxPDO mapping object)	UINT16	RW	0x1A01 (6657 <sub>dec</sub> )
1C13:03	Subindex 003	3. allocated TxPDO (contains the index of the associated TxPDO mapping object)	UINT16	RW	0x1A02 (6658 <sub>dec</sub> )
1C13:04	Subindex 004	4. allocated TxPDO (contains the index of the associated TxPDO mapping object)	UINT16	RW	0x1A03 (6659 <sub>dec</sub> )
1C13:05	Subindex 005	5. allocated TxPDO (contains the index of the associated TxPDO mapping object)	UINT16	RW	0x1A04 (6660 <sub>dec</sub> )
1C13:06	Subindex 006	6. allocated TxPDO (contains the index of the associated TxPDO mapping object)	UINT16	RW	0x1A06 (6662 <sub>dec</sub> )

**Index 1C33 SM input parameter**

Index (hex)	Name	Meaning	Data type	Flags	Default
1C33:0	SM input parameter	Synchronization parameters for the inputs	UINT8	RO	0x20 (32 <sub>dec</sub> )
1C33:01	Sync mode	Current synchronization mode: <ul style="list-style-type: none"> <li>• 0: Free Run</li> <li>• 1: Synchron with SM 3 Event (no outputs available)</li> <li>• 2: DC - Synchron with SYNC0 Event</li> <li>• 3: DC - Synchron with SYNC1 Event</li> <li>• 34: Synchron with SM 2 Event (outputs available)</li> </ul>	UINT16	RW	0x0022 (34 <sub>dec</sub> )
1C33:02	Cycle time	Cycle time (in ns): <ul style="list-style-type: none"> <li>• Free Run: Cycle time of the local timer</li> <li>• Synchron with SM 2 Event: Master cycle time</li> <li>• DC mode: SYNC0/SYNC1 Cycle Time</li> </ul>	UINT32	RW	0x000F4240 (1000000 <sub>dec</sub> )
1C33:03	Shift time	Time between SYNC0 event and reading of the inputs (in ns, only DC mode)	UINT32	RO	0x00000000 (0 <sub>dec</sub> )
1C33:04	Sync modes supported	Supported synchronization modes: <ul style="list-style-type: none"> <li>• Bit 0: free run is supported</li> <li>• Bit 1: Synchron with SM 2 Event is supported (outputs available)</li> <li>• Bit 1: Synchron with SM 3 Event is supported (no outputs available)</li> <li>• Bit 2-3 = 01: DC mode is supported</li> <li>• Bit 4-5 = 01: Input Shift through local event (outputs available)</li> <li>• Bit 4-5 = 10: Input Shift with SYNC1 event (no outputs available)</li> <li>• Bit 14 = 1: dynamic times (measurement through writing of 0x1C32:08 or 0x1C33:08)</li> </ul>	UINT16	RO	0x0003 (3 <sub>dec</sub> )
1C33:05	Minimum cycle time	Minimum cycle time supported (in ns)	UINT32	RO	0x0003D040 (20000 <sub>dec</sub> )
1C33:06	Calc and copy time	Time between reading of the inputs and availability of the inputs for the master (in ns, only DC mode)	UINT32	RO	0x00000000 (0 <sub>dec</sub> )
1C33:07	Minimum delay time		UINT32	RO	0x00000000 (0 <sub>dec</sub> )
1C33:08	Command	With this entry the real required process data provision time can be measured. 0: Measurement of the local cycle time is stopped 1: Measurement of the local cycle time is started The entries 0x1C33:03, 0x1C33:06, 0x1C33:09 are updated with the maximum measured values. For a subsequent measurement the measured values are reset	UINT16	RW	0x0000 (0 <sub>dec</sub> )
1C33:09	Maximum Delay time	Time between SYNC1 event and reading of the inputs (in ns, only DC mode)	UINT32	RO	0x00000000 (0 <sub>dec</sub> )
1C33:0B	SM event missed counter	Number of missed SM events in OPERATIONAL (DC mode only)	UINT16	RO	0x0000 (0 <sub>dec</sub> )
1C33:0C	Cycle exceeded counter	Number of occasions the cycle time was exceeded in OPERATIONAL (cycle was not completed in time or the next cycle began too early)	UINT16	RO	0x0000 (0 <sub>dec</sub> )
1C33:0D	Shift too short counter	Number of occasions that the interval between SYNC0 and SYNC1 event was too short (DC mode only)	UINT16	RO	0x0000 (0 <sub>dec</sub> )
1C33:20	Sync error	The synchronization was not correct in the last cycle (outputs were output too late; DC mode only)	BOOLEAN	RO	0x00 (0 <sub>dec</sub> )

**Profile-specific objects (0x6000-0xFFFF)**

The profile-specific objects have the same meaning for all EtherCAT slaves that support the profile 5001.

**Index 6000 AI Inputs Ch.1**

Index (hex)	Name	Meaning	Data type	Flags	Default
6000:0	AI Inputs Ch.1		UINT8	RO	0x11 (17 <sub>dec</sub> )
6000:07	Error		BOOLEAN	RO	0x00 (0 <sub>dec</sub> )
6000:0F	TxPDO State		BOOLEAN	RO	0x00 (0 <sub>dec</sub> )
6000:10	TxPDO Toggle		BOOLEAN	RO	0x00 (0 <sub>dec</sub> )
6000:11	Value		INT16	RO	0x0000 (0 <sub>dec</sub> )

**Index 6010 AI Inputs Ch.2**

Index (hex)	Name	Meaning	Data type	Flags	Default
6010:0	AI Inputs Ch.2		UINT8	RO	0x11 (17 <sub>dec</sub> )
6010:07	Error		BOOLEAN	RO	0x00 (0 <sub>dec</sub> )
6010:0F	TxPDO State		BOOLEAN	RO	0x00 (0 <sub>dec</sub> )
6010:10	TxPDO Toggle		BOOLEAN	RO	0x00 (0 <sub>dec</sub> )
6010:11	Value		INT16	RO	0x0000 (0 <sub>dec</sub> )

**Index 6020 AI Inputs Ch.3**

Index (hex)	Name	Meaning	Data type	Flags	Default
6020:0	AI Inputs Ch.3		UINT8	RO	0x11 (17 <sub>dec</sub> )
6020:07	Error		BOOLEAN	RO	0x00 (0 <sub>dec</sub> )
6020:0F	TxPDO State		BOOLEAN	RO	0x00 (0 <sub>dec</sub> )
6020:10	TxPDO Toggle		BOOLEAN	RO	0x00 (0 <sub>dec</sub> )
6020:11	Value		INT16	RO	0x0000 (0 <sub>dec</sub> )

**Index 6030 AI Inputs Ch.4**

Index (hex)	Name	Meaning	Data type	Flags	Default
6030:0	AI Inputs Ch.4		UINT8	RO	0x11 (17 <sub>dec</sub> )
6030:07	Error		BOOLEAN	RO	0x00 (0 <sub>dec</sub> )
6030:0F	TxPDO State		BOOLEAN	RO	0x00 (0 <sub>dec</sub> )
6030:10	TxPDO Toggle		BOOLEAN	RO	0x00 (0 <sub>dec</sub> )
6030:11	Value		INT16	RO	0x0000 (0 <sub>dec</sub> )

**Index 6040 AI Inputs Ch.5**

Index (hex)	Name	Meaning	Data type	Flags	Default
6040:0	AI Inputs Ch.5		UINT8	RO	0x11 (17 <sub>dec</sub> )
6040:07	Error		BOOLEAN	RO	0x00 (0 <sub>dec</sub> )
6040:0F	TxPDO State		BOOLEAN	RO	0x00 (0 <sub>dec</sub> )
6040:10	TxPDO Toggle		BOOLEAN	RO	0x00 (0 <sub>dec</sub> )
6040:11	Value		INT16	RO	0x0000 (0 <sub>dec</sub> )

**Index 6050 AI Inputs Ch.6**

Index (hex)	Name	Meaning	Data type	Flags	Default
6050:0	AI Inputs Ch.6		UINT8	RO	0x11 (17 <sub>dec</sub> )
6050:07	Error		BOOLEAN	RO	0x00 (0 <sub>dec</sub> )
6050:0F	TxPDO State		BOOLEAN	RO	0x00 (0 <sub>dec</sub> )
6050:10	TxPDO Toggle		BOOLEAN	RO	0x00 (0 <sub>dec</sub> )
6050:11	Value		INT16	RO	0x0000 (0 <sub>dec</sub> )

**Index F000 Modular device profile**

Index (hex)	Name	Meaning	Data type	Flags	Default
F000:0	Modular device profile	General information for the modular device profile	UINT8	RO	0x02 (2 <sub>dec</sub> )
F000:01	Module index distance	Index distance of the objects of the individual channels	UINT16	RO	0x0010 (16 <sub>dec</sub> )
F000:02	Maximum number of modules	Number of channels	UINT16	RO	0x0002 (2 <sub>dec</sub> )

**Index F008 Code word**

Index (hex)	Name	Meaning	Data type	Flags	Default
F008:0	Code word		UINT32	RW	0x00000000 (0 <sub>dec</sub> )

**Index F010 Module list**

Index (hex)	Name	Meaning	Data type	Flags	Default
F010:0	Module list		UINT8	RW	0x02 (2 <sub>dec</sub> )
F010:01	SubIndex 001		UINT32	RW	0x00000258 (600 <sub>dec</sub> )
F010:02	SubIndex 002		UINT32	RW	0x00000258 (600 <sub>dec</sub> )

## 7 Appendix

### 7.1 General operating conditions

#### Protection degrees (IP-Code)

The standard IEC 60529 (DIN EN 60529) defines the degrees of protection in different classes.

1. Number: dust protection and touch guard	Definition
0	Non-protected
1	Protected against access to hazardous parts with the back of a hand. Protected against solid foreign objects of Ø 50 mm
2	Protected against access to hazardous parts with a finger. Protected against solid foreign objects of Ø 12.5 mm.
3	Protected against access to hazardous parts with a tool. Protected against solid foreign objects Ø 2.5 mm.
4	Protected against access to hazardous parts with a wire. Protected against solid foreign objects Ø 1 mm.
5	Protected against access to hazardous parts with a wire. Dust-protected. Intrusion of dust is not totally prevented, but dust shall not penetrate in a quantity to interfere with satisfactory operation of the device or to impair safety.
6	Protected against access to hazardous parts with a wire. Dust-tight. No intrusion of dust.
2. Number: water* protection	Definition
0	Non-protected
1	Protected against water drops
2	Protected against water drops when enclosure tilted up to 15°.
3	Protected against spraying water. Water sprayed at an angle up to 60° on either side of the vertical shall have no harmful effects.
4	Protected against splashing water. Water splashed against the disclosure from any direction shall have no harmful effects
5	Protected against water jets
6	Protected against powerful water jets
7	Protected against the effects of temporary immersion in water. Intrusion of water in quantities causing harmful effects shall not be possible when the enclosure is temporarily immersed in water for 30 min. in 1 m depth.

\*) These protection classes define only protection against water.

#### Chemical Resistance

The Resistance relates to the Housing of the IP67 modules and the used metal parts. In the table below you will find some typical resistance.

Character	Resistance
Steam	at temperatures >100°C: not resistant
Sodium base liquor (ph-Value > 12)	at room temperature: resistant > 40°C: not resistant
Acetic acid	not resistant
Argon (technical clean)	resistant

#### Key

- resistant: Lifetime several months
- non inherently resistant: Lifetime several weeks
- not resistant: Lifetime several hours resp. early decomposition

## 7.2 Accessories

### Mounting

Ordering information	Description	Link
ZS5300-0011	Mounting rail	<a href="#">Website</a>

### Cables

A complete overview of pre-assembled cables for fieldbus components can be found [here](#).

Ordering information	Description	Link
ZK700x-xxxx-xxxx	EtherCAT P cable M8	<a href="#">Website</a>

### Labeling material, protective caps

Ordering information	Description
ZS5000-0010	Protective cap for M8 sockets, IP67 (50 pieces)
ZS5100-0000	Inscription labels, unprinted, 4 strips of 10
ZS5000-xxxx	Printed inscription labels on enquiry

### Tools

Ordering information	Description
ZB8801-0000	Torque wrench for plugs, 0.4...1.0 Nm
ZB8801-0001	Torque cable key for M8 / wrench size 9 for ZB8801-0000



### Further accessories

Further accessories can be found in the price list for fieldbus components from Beckhoff and online at <https://www.beckhoff.com>.

## 7.3 Version identification of EtherCAT devices

### 7.3.1 General notes on marking

#### Designation

A Beckhoff EtherCAT device has a 14-digit designation, made up of

- family key
- type
- version
- revision

Example	Family	Type	Version	Revision
EL3314-0000-0016	EL terminal (12 mm, non-pluggable connection level)	3314 (4-channel thermocouple terminal)	0000 (basic type)	0016
ES3602-0010-0017	ES terminal (12 mm, pluggable connection level)	3602 (2-channel voltage measurement)	0010 (high-precision version)	0017
CU2008-0000-0000	CU device	2008 (8-port fast ethernet switch)	0000 (basic type)	0000

#### Notes

- The elements mentioned above result in the **technical designation**. EL3314-0000-0016 is used in the example below.
- EL3314-0000 is the order identifier, in the case of “-0000” usually abbreviated to EL3314. “-0016” is the EtherCAT revision.
- The **order identifier** is made up of
  - family key (EL, EP, CU, ES, KL, CX, etc.)
  - type (3314)
  - version (-0000)
- The **revision** -0016 shows the technical progress, such as the extension of features with regard to the EtherCAT communication, and is managed by Beckhoff.  
In principle, a device with a higher revision can replace a device with a lower revision, unless specified otherwise, e.g. in the documentation.  
Associated and synonymous with each revision there is usually a description (ESI, EtherCAT Slave Information) in the form of an XML file, which is available for download from the Beckhoff web site.  
From 2014/01 the revision is shown on the outside of the IP20 terminals, see Fig. “EL5021 EL terminal, standard IP20 IO device with batch number and revision ID (since 2014/01)”.
- The type, version and revision are read as decimal numbers, even if they are technically saved in hexadecimal.



### 7.3.2 Version identification of EP/EPI/EPP/ER/ERI boxes

The serial number/ data code for Beckhoff IO devices is usually the 8-digit number printed on the device or on a sticker. The serial number indicates the configuration in delivery state and therefore refers to a whole production batch, without distinguishing the individual modules of a batch.

Structure of the serial number: **KK YY FF HH**

- KK - week of production (CW, calendar week)
- YY - year of production
- FF - firmware version
- HH - hardware version

Example with serial number 12 06 3A 02:

- 12 - production week 12
- 06 - production year 2006
- 3A - firmware version 3A
- 02 - hardware version 02

Exceptions can occur in the **IP67 area**, where the following syntax can be used (see respective device documentation):

Syntax: D ww yy x y z u

- D - prefix designation
- ww - calendar week
- yy - year
- x - firmware version of the bus PCB
- y - hardware version of the bus PCB
- z - firmware version of the I/O PCB
- u - hardware version of the I/O PCB

Example: D.22081501 calendar week 22 of the year 2008 firmware version of bus PCB: 1 hardware version of bus PCB: 5 firmware version of I/O PCB: 0 (no firmware necessary for this PCB) hardware version of I/O PCB: 1

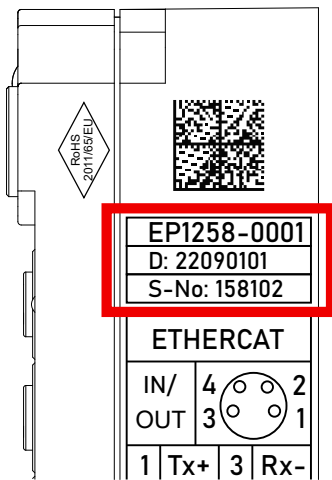

Fig. 8: EP1258-0001 IP67 EtherCAT Box with batch number/DateCode 22090101 and unique serial number 158102

### 7.3.3 Beckhoff Identification Code (BIC)

The Beckhoff Identification Code (BIC) is increasingly being applied to Beckhoff products to uniquely identify the product. The BIC is represented as a Data Matrix Code (DMC, code scheme ECC200), the content is based on the ANSI standard MH10.8.2-2016.

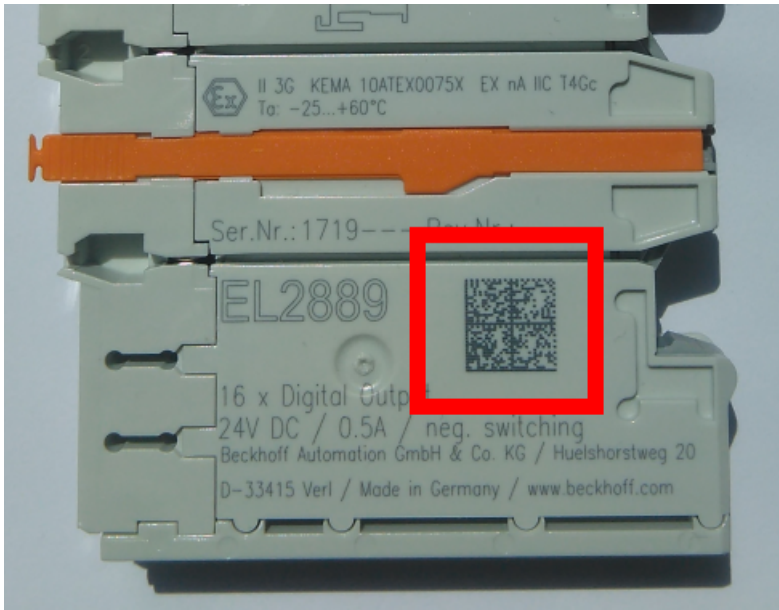

Fig. 9: BIC as data matrix code (DMC, code scheme ECC200)

The BIC will be introduced step by step across all product groups.

Depending on the product, it can be found in the following places:

- on the packaging unit
- directly on the product (if space suffices)
- on the packaging unit and the product

The BIC is machine-readable and contains information that can also be used by the customer for handling and product management.

Each piece of information can be uniquely identified using the so-called data identifier (ANSI MH10.8.2-2016). The data identifier is followed by a character string. Both together have a maximum length according to the table below. If the information is shorter, spaces are added to it.

Following information is possible, positions 1 to 4 are always present, the other according to need of production:

Position	Type of information	Explanation	Data identifier	Number of digits incl. data identifier	Example
1	Beckhoff order number	<b>Beckhoff order number</b>	1P	8	<b>1P</b> 072222
2	Beckhoff Traceability Number (BTN)	<b>Unique serial number, see note below</b>	SBTN	12	<b>SBTN</b> k4p562d7
3	Article description	<b>Beckhoff article description, e.g. EL1008</b>	1K	32	<b>1K</b> EL1809
4	Quantity	<b>Quantity in packaging unit, e.g. 1, 10, etc.</b>	Q	6	<b>Q</b> 1
5	Batch number	Optional: Year and week of production	2P	14	<b>2P</b> 401503180016
6	ID/serial number	Optional: Present-day serial number system, e.g. with safety products	51S	12	<b>51S</b> 678294
7	Variant number	Optional: Product variant number on the basis of standard products	30P	32	<b>30P</b> F971, 2*K183
...					

Further types of information and data identifiers are used by Beckhoff and serve internal processes.

**Structure of the BIC**

Example of composite information from positions 1 to 4 and with the above given example value on position 6. The data identifiers are highlighted in bold font:

**1P**072222**SBTN**k4p562d7**1K**EL1809 **Q**1 **51S**678294

Accordingly as DMC:



Fig. 10: Example DMC **1P**072222**SBTN**k4p562d7**1K**EL1809 **Q**1 **51S**678294

**BTN**

An important component of the BIC is the Beckhoff Traceability Number (BTN, position 2). The BTN is a unique serial number consisting of eight characters that will replace all other serial number systems at Beckhoff in the long term (e.g. batch designations on IO components, previous serial number range for safety products, etc.). The BTN will also be introduced step by step, so it may happen that the BTN is not yet coded in the BIC.

**NOTE**

This information has been carefully prepared. However, the procedure described is constantly being further developed. We reserve the right to revise and change procedures and documentation at any time and without prior notice. No claims for changes can be made from the information, illustrations and descriptions in this information.

## 7.3.4 Electronic access to the BIC (eBIC)

### Electronic BIC (eBIC)

The Beckhoff Identification Code (BIC) is applied to the outside of Beckhoff products in a visible place. If possible, it should also be electronically readable.

Decisive for the electronic readout is the interface via which the product can be electronically addressed.

### K-bus devices (IP20, IP67)

Currently, no electronic storage and readout is planned for these devices.

### EtherCAT devices (IP20, IP67)

All Beckhoff EtherCAT devices have a so-called ESI-EEPROM, which contains the EtherCAT identity with the revision number. Stored in it is the EtherCAT slave information, also colloquially known as ESI/XML configuration file for the EtherCAT master. See the corresponding chapter in the EtherCAT system manual ([Link](#)) for the relationships.

The eBIC is also stored in the ESI-EEPROM. The eBIC was introduced into the Beckhoff I/O production (terminals, box modules) from 2020; widespread implementation is expected in 2021.

The user can electronically access the eBIC (if existent) as follows:

- With all EtherCAT devices, the EtherCAT master (TwinCAT) can read the eBIC from the ESI-EEPROM
  - From TwinCAT 3.1 build 4024.11, the eBIC can be displayed in the online view.
  - To do this, check the checkbox "Show Beckhoff Identification Code (BIC)" under EtherCAT → Advanced Settings → Diagnostics:

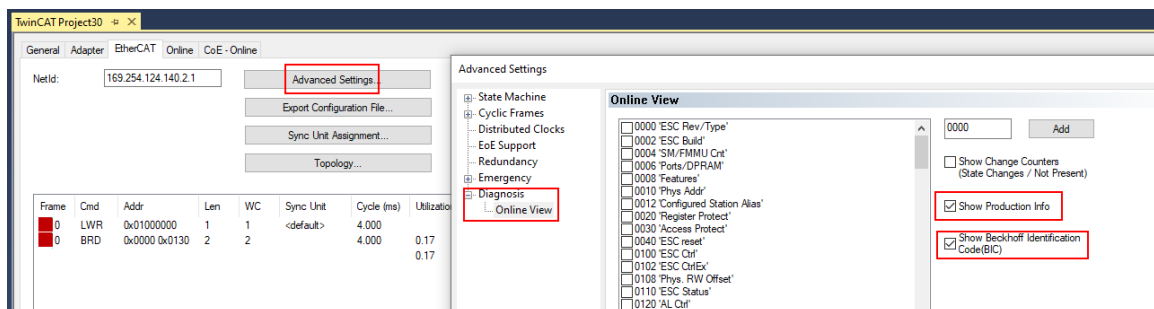

- The BTN and its contents are then displayed:

No	Addr	Name	State	CRC	Fw	Hw	Production Data	ItemNo	BTN	Description	Quantity	BatchNo	SerialNo
1	1001	Term 1 (EK1100)	OP	0,0	0	0	---						
2	1002	Term 2 (EL1018)	OP	0,0	0	0	2020 KW36 Fr	072222	k4p562d7	EL1809	1		678294
3	1003	Term 3 (EL3204)	OP	0,0	7	6	2012 KW24 Sa						
4	1004	Term 4 (EL2004)	OP	0,0	0	0	---	072223	k4p562d7	EL2004	1		678295
5	1005	Term 5 (EL1008)	OP	0,0	0	0	---						
6	1006	Term 6 (EL2008)	OP	0,0	0	12	2014 KW14 Mo						
7	1007	Term 7 (EK1110)	OP	0	1	8	2012 KW25 Mo						

- Note: as can be seen in the illustration, the production data HW version, FW version and production date, which have been programmed since 2012, can also be displayed with "Show Production Info".
- From TwinCAT 3.1. build 4024.24 the functions *FB\_EcReadBIC* and *FB\_EcReadBTN* for reading into the PLC and further eBIC auxiliary functions are available in the Tc2\_EtherCAT Library from v3.3.19.0.
- In the case of EtherCAT devices with CoE directory, the object 0x10E2:01 can additionally be used to display the device's own eBIC; the PLC can also simply access the information here:

- The device must be in PREOP/SAFEOP/OP for access:

Index	Name	Flags	Value
1000	Device type	RO	0x015E1389 (22942601)
1008	Device name	RO	ELM3704-0000
1009	Hardware version	RO	00
100A	Software version	RO	01
100B	Bootloader version	RO	J0.1.27.0
1011:0	Restore default parameters	RO	> 1 <
1018:0	Identity	RO	> 4 <
10E2:0	Manufacturer-specific Identification C...	RO	> 1 <
10E2:01	SubIndex 001	RO	1P158442SBTN0008jekp1KELM3704 Q1 2P482001000016
10F0:0	Backup parameter handling	RO	> 1 <
10F3:0	Diagnosis History	RO	> 21 <
10F8	Actual Time Stamp	RO	0x170bfb277e

- the object 0x10E2 will be introduced into stock products in the course of a necessary firmware revision.
- From TwinCAT 3.1. build 4024.24 the functions *FB\_EcCoEReadBIC* and *FB\_EcCoEReadBTN* for reading into the PLC and further eBIC auxiliary functions are available in the *Tc2\_EtherCAT Library* from v3.3.19.0.
- Note: in the case of electronic further processing, the BTN is to be handled as a string(8); the identifier "SBTN" is not part of the BTN.
- Technical background  
The new BIC information is additionally written as a category in the ESI-EEPROM during the device production. The structure of the ESI content is largely dictated by the ETG specifications, therefore the additional vendor-specific content is stored with the help of a category according to ETG.2010. ID 03 indicates to all EtherCAT masters that they must not overwrite these data in case of an update or restore the data after an ESI update.  
The structure follows the content of the BIC, see there. This results in a memory requirement of approx. 50..200 bytes in the EEPROM.
- Special cases
  - If multiple, hierarchically arranged ESCs are installed in a device, only the top-level ESC carries the eBIC Information.
  - If multiple, non-hierarchically arranged ESCs are installed in a device, all ESCs carry the eBIC Information.
  - If the device consists of several sub-devices with their own identity, but only the top-level device is accessible via EtherCAT, the eBIC of the top-level device is located in the CoE object directory 0x10E2:01 and the eBICs of the sub-devices follow in 0x10E2:nn.

**Profibus/Profinet/DeviceNet... Devices**

Currently, no electronic storage and readout is planned for these devices.

## 7.4 Support and Service

Beckhoff and their partners around the world offer comprehensive support and service, making available fast and competent assistance with all questions related to Beckhoff products and system solutions.

### Beckhoff's branch offices and representatives

Please contact your Beckhoff branch office or representative for local support and service on Beckhoff products!

The addresses of Beckhoff's branch offices and representatives round the world can be found on her internet pages: <https://www.beckhoff.com>

You will also find further documentation for Beckhoff components there.

### Beckhoff Support

Support offers you comprehensive technical assistance, helping you not only with the application of individual Beckhoff products, but also with other, wide-ranging services:

- support
- design, programming and commissioning of complex automation systems
- and extensive training program for Beckhoff system components

Hotline: +49 5246 963 157  
Fax: +49 5246 963 9157  
e-mail: [support@beckhoff.com](mailto:support@beckhoff.com)

### Beckhoff Service

The Beckhoff Service Center supports you in all matters of after-sales service:

- on-site service
- repair service
- spare parts service
- hotline service

Hotline: +49 5246 963 460  
Fax: +49 5246 963 479  
e-mail: [service@beckhoff.com](mailto:service@beckhoff.com)

### Beckhoff Headquarters

Beckhoff Automation GmbH & Co. KG

Huelshorstweg 20  
33415 Verl  
Germany

Phone: +49 5246 963 0  
Fax: +49 5246 963 198  
e-mail: [info@beckhoff.com](mailto:info@beckhoff.com)  
web: <https://www.beckhoff.com>



More Information:  
[www.beckhoff.com/epp3752-0000](http://www.beckhoff.com/epp3752-0000)

Beckhoff Automation GmbH & Co. KG  
Hülshorstweg 20  
33415 Verl  
Germany  
Phone: +49 5246 9630  
[info@beckhoff.com](mailto:info@beckhoff.com)  
[www.beckhoff.com](http://www.beckhoff.com)

