

# Montageanleitung B23

konfektionierbares Steckergehäuse mit Crimpanschluss, axial,  
5x4 mm<sup>2</sup>, PWR: Powerbuchse

## Stückliste

Dichtung	Kabel Außendurchmesser
	Ø13 - <15mm
	Ø15 - 16mm

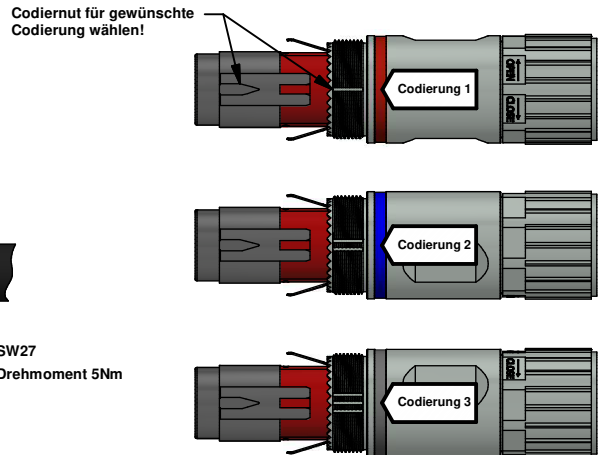
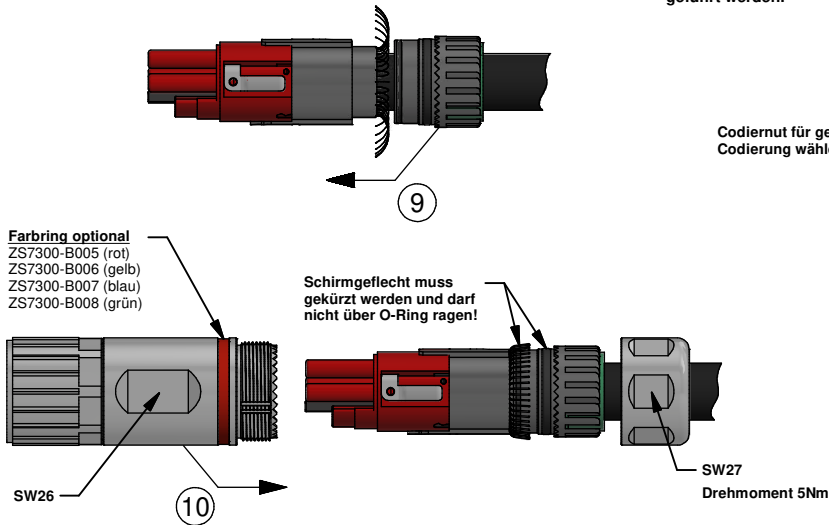
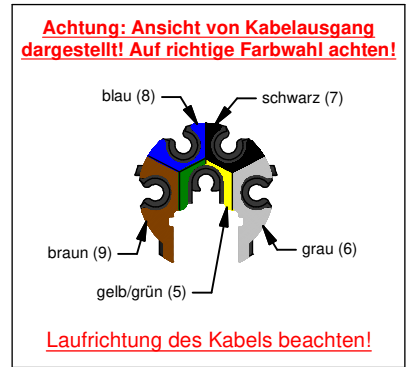
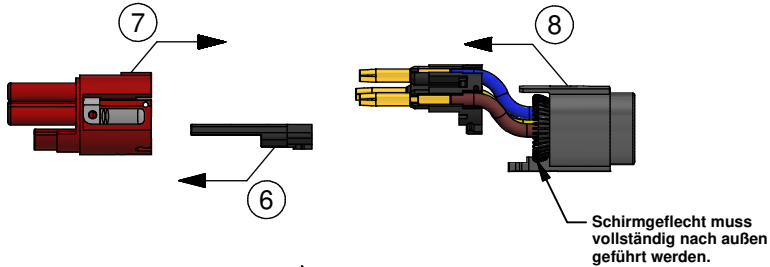
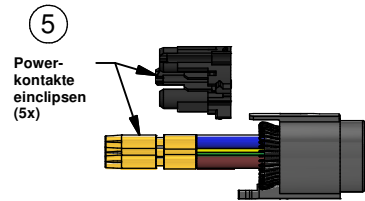
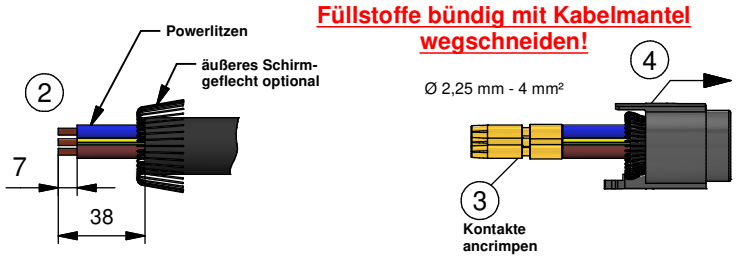
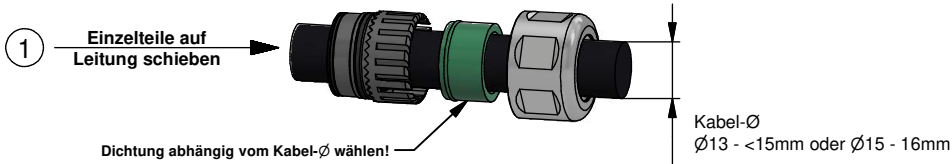

Beckhoff®, TwinCAT®, EtherCAT®, EtherCAT P®, Safety over EtherCAT®, TwinSAFE®, XFC® und XTS® sind eingetragene und lizenzierte Marken der Beckhoff Automation GmbH.  
Die Verwendung anderer in dieser Dokumentation enthaltenen Marken oder Kennzeichen durch Dritte kann zu einer Verletzung von Rechten der Inhaber der entsprechenden Kennzeichen führen.

© Beckhoff Automation GmbH & Co. KG 08/2016

Die Informationen in dieser Druckschrift enthalten lediglich allgemeine Beschreibungen bzw. Leistungsmerkmale, welche im konkreten Anwendungsfall nicht immer in der beschriebenen Form zutreffen bzw. welche sich durch Weiterentwicklung der Produkte ändern können. Die gewünschten Leistungsmerkmale sind nur dann verbindlich, wenn sie bei Vertragsabschluss ausdrücklich vereinbart werden.

790-981800 / 7901A537 Rev. a  
Beckhoff Art.-Nr.: ZS7300 - 0023

Werkzeug / Zubehör	
Crimpzange	Crimpeinsatz / Locator
ZB8810-0000	ZB8810-0002

# Assembly instruction B23

field attachable plug housing with crimp connection, axial,  
5x4 mm<sup>2</sup>, PWR: power (female)

## parts list

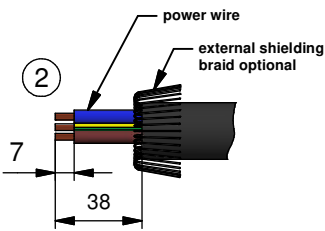
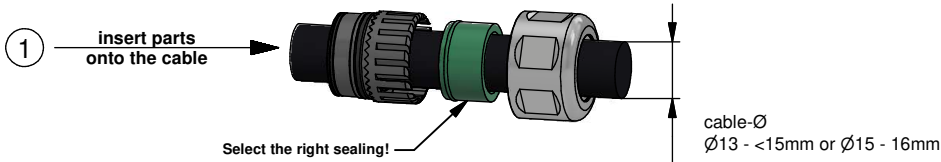
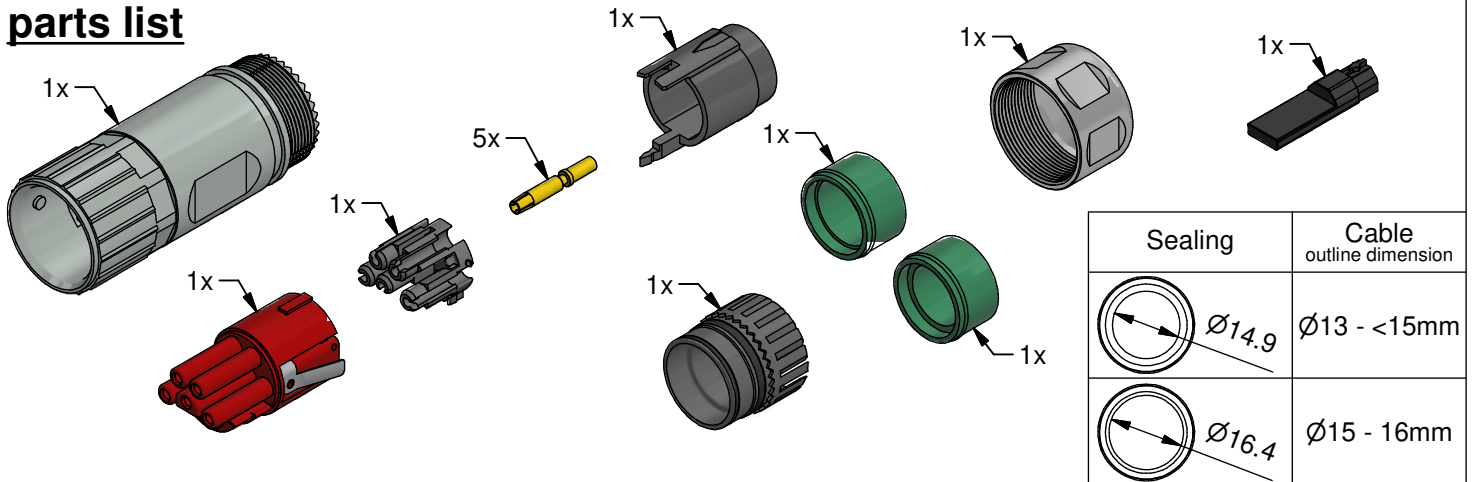

**Cut off the fillers!**

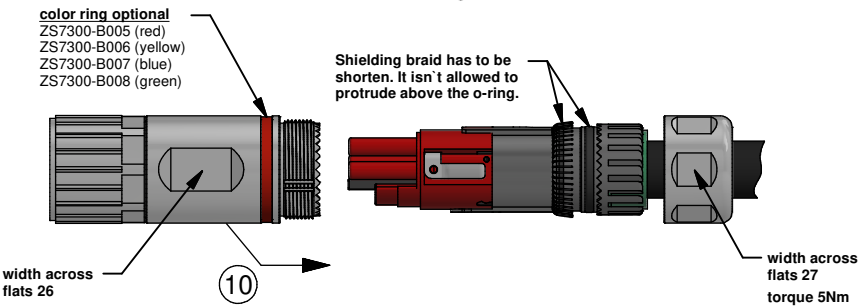
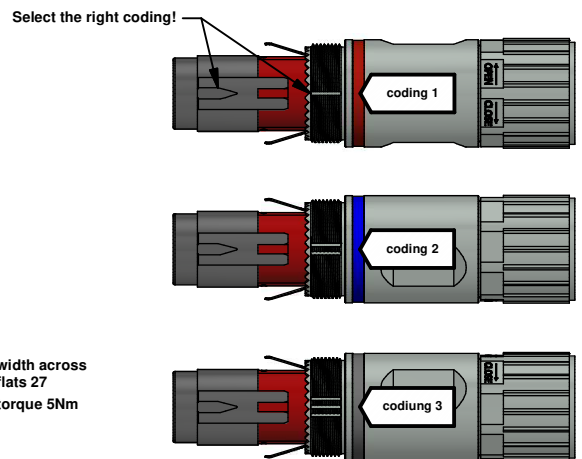
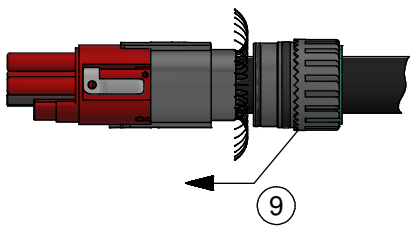
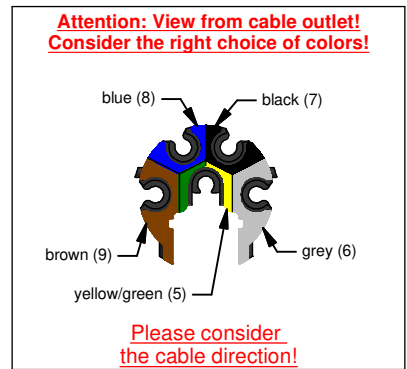
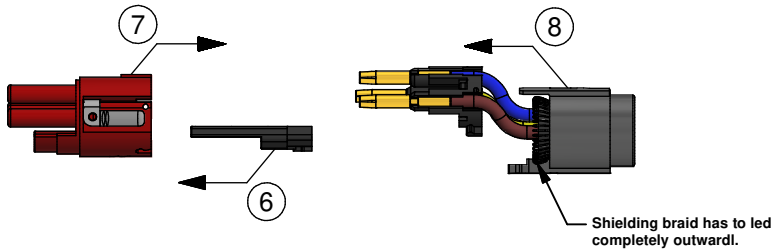
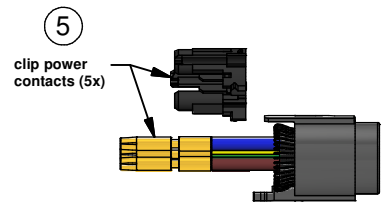
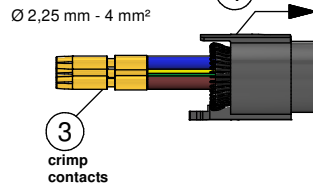

Beckhoff®, TwinCAT®, EtherCAT®, EtherCAT P®, Safety over EtherCAT®, TwinSAFE®, XFC® and XTS® are registered trademarks of and licensed by Beckhoff Automation GmbH. Other designations used in this publication may be trademarks whose use by third parties for their own purposes could violate the rights of the owners.

The information provided in this brochure contains merely general descriptions or characteristics of performance which in case of actual application do not always apply as described or which may change as a result of further development of the products. An obligation to provide the respective characteristics shall only exist if expressly agreed in the terms of contract.

tools / accessory parts	
crimping tool	crimping insert / locator
ZB8810-0000	ZB8810-0002