

bottom view

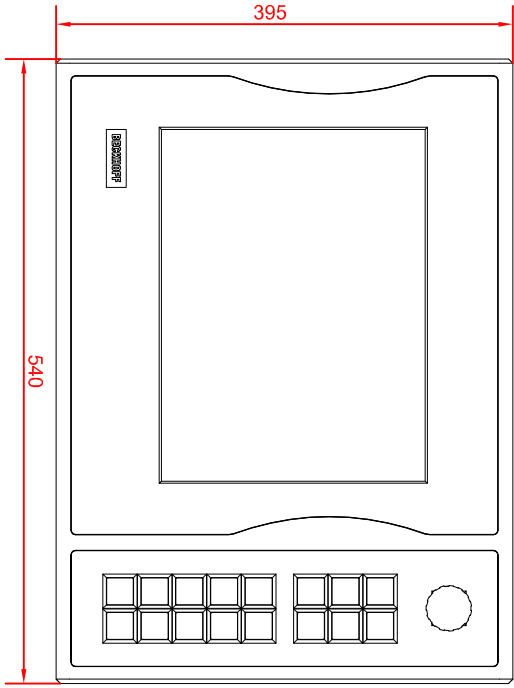

front view

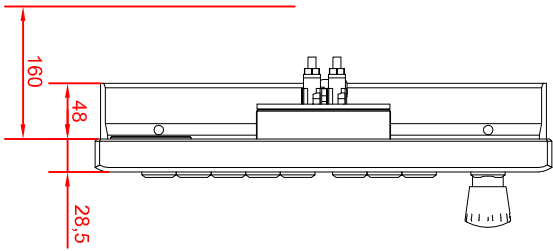

left view

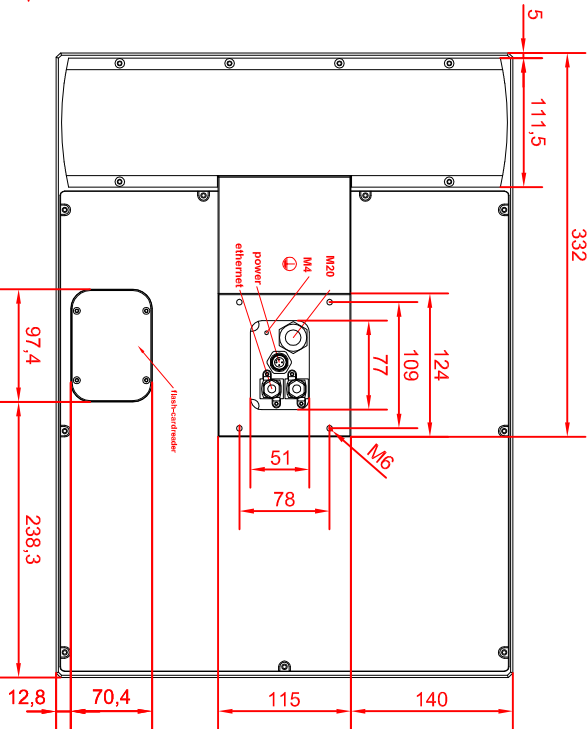

rear view

CP7712-0001-E858  
 arm adapter for  
 Rolec - Tara - suspension adaption  
 146.025.019

main dimensions and  
 fixing points  
 dimensions in mm

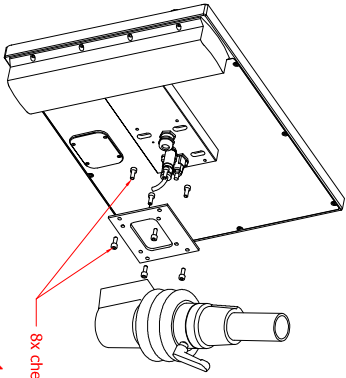

8x cheese head screw M6x16

149.025.013  
 149.025.014

