

bottom view

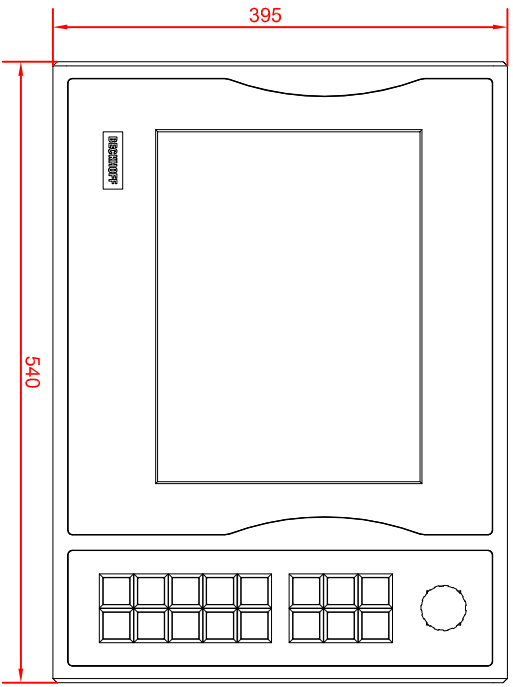

front view

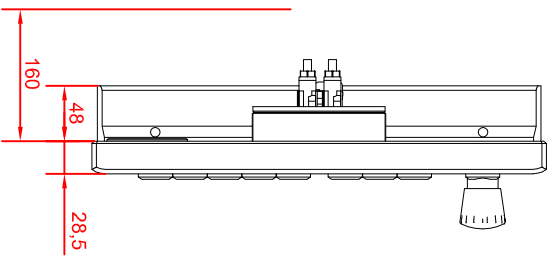

left view

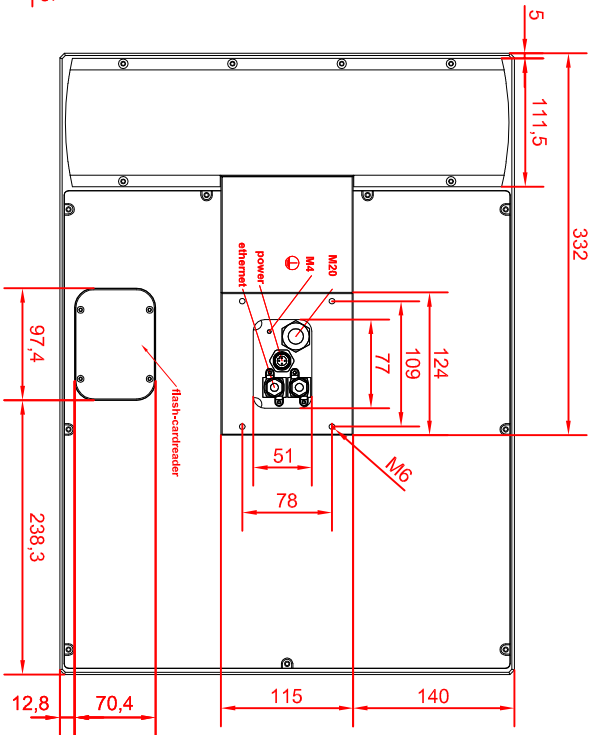

rear view

CP7702-0001-E848  
 arm adapter for  
 Rolec - Tara - suspension adaption  
 149.025.019

main dimensions and  
 fixing points

dimensions in mm

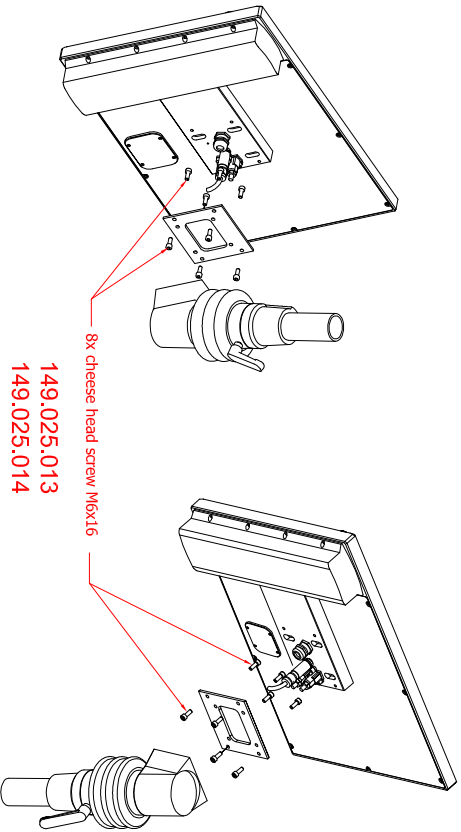

8x cheese head screw M6x16

149.025.013  
 149.025.014