

bottom view

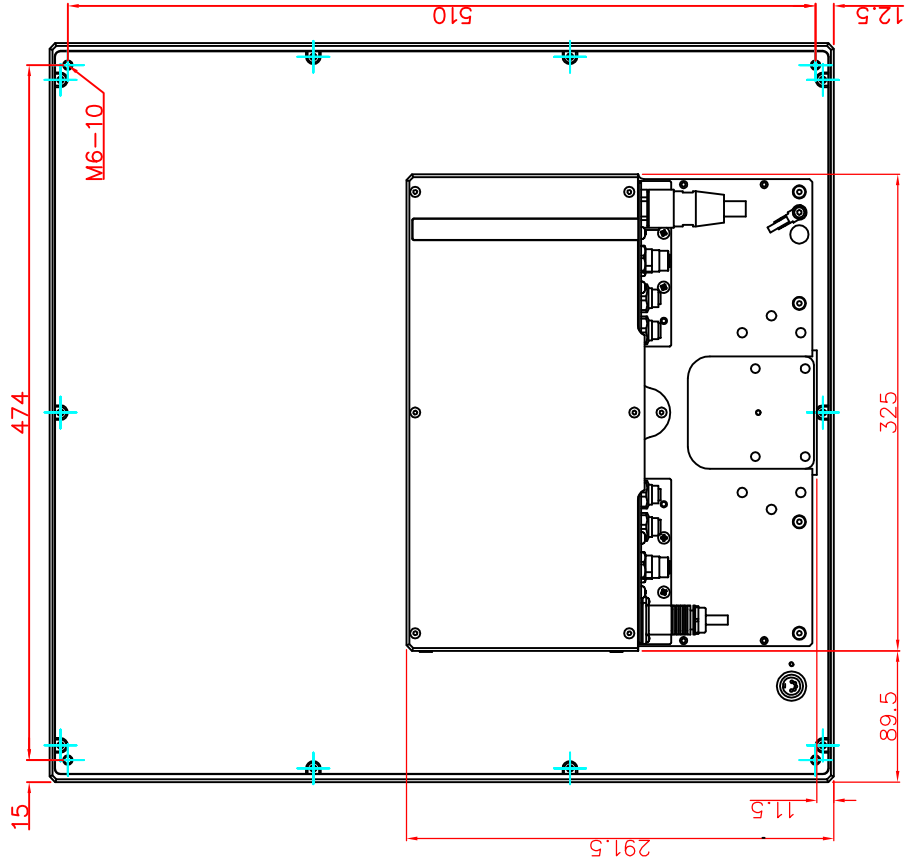

rear view

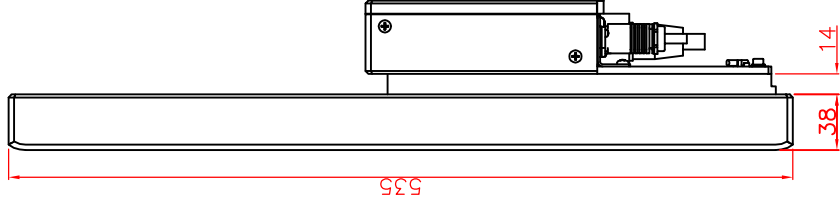

right view

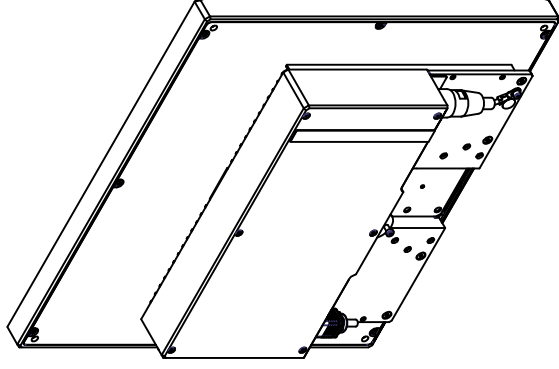

CP7233-0001-M164-E169

main dimensions and fixing
points

dimensions in mm

dimensions in mm