

bottom view

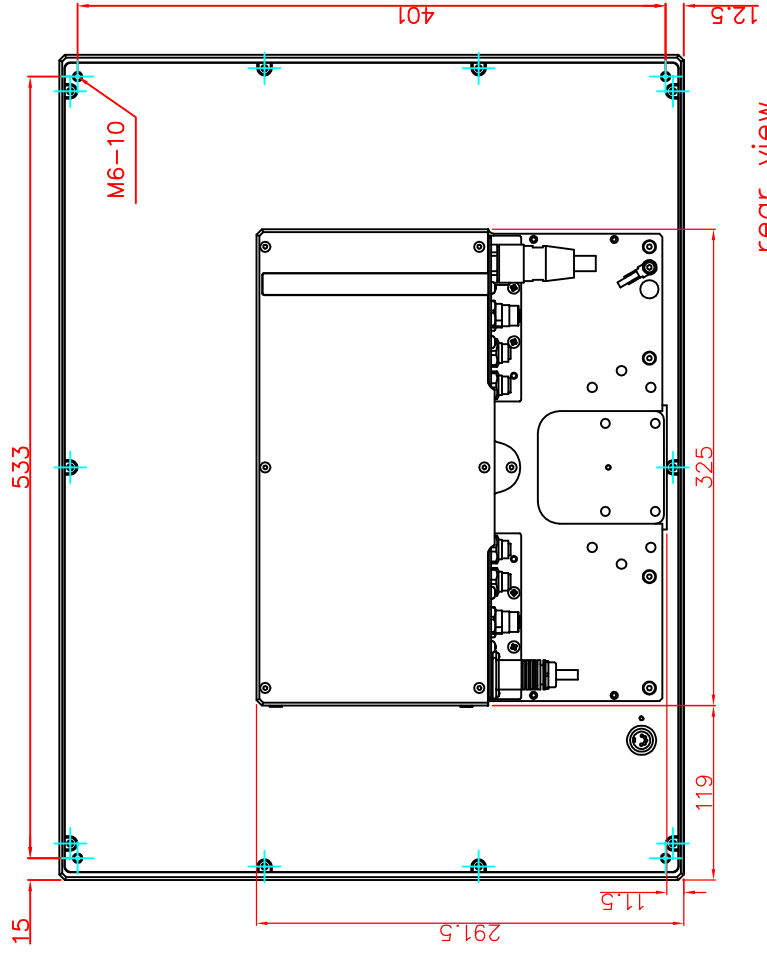

rear view

dimensions in mm

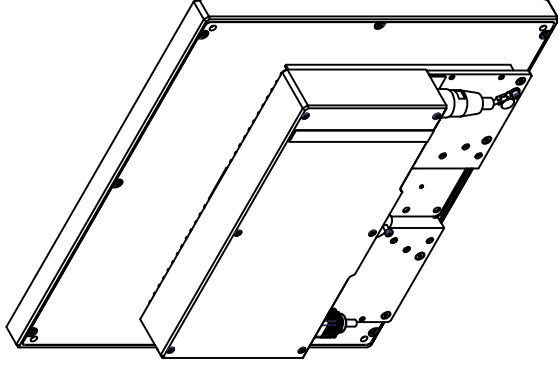

CP7223-0000-M164-E169

main dimensions and fixing points

dimensions in mm

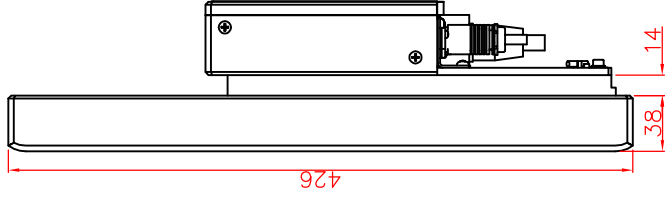

right view