

bottom view

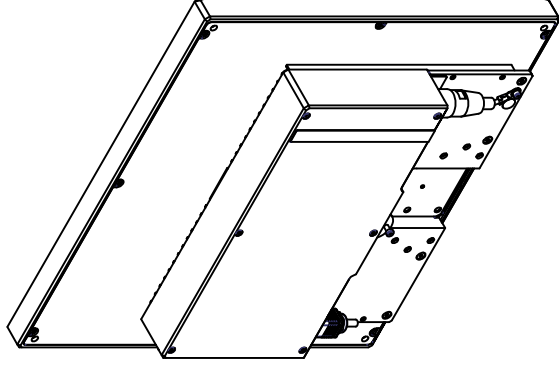

CP7202-0001-M164

main dimensions and fixing points

dimensions in mm

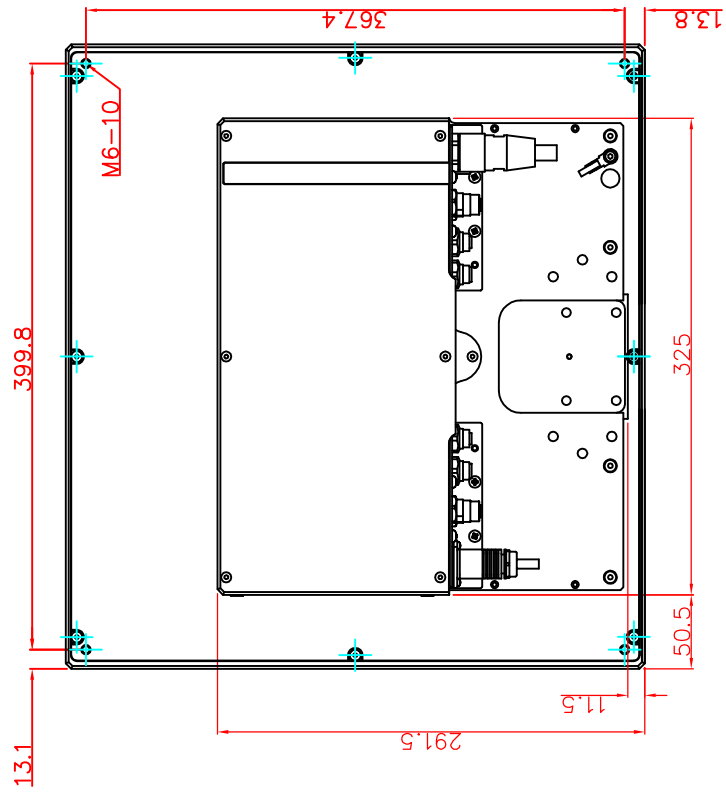

rear view

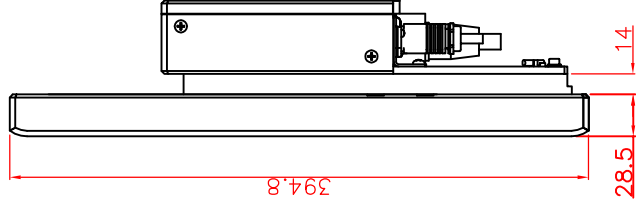

right view

dimensions in mm