

CP6733-0002-0040

main dimensions and
fixing points

dimensions in mm

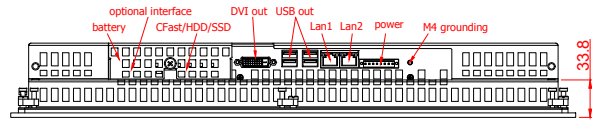

bottom view

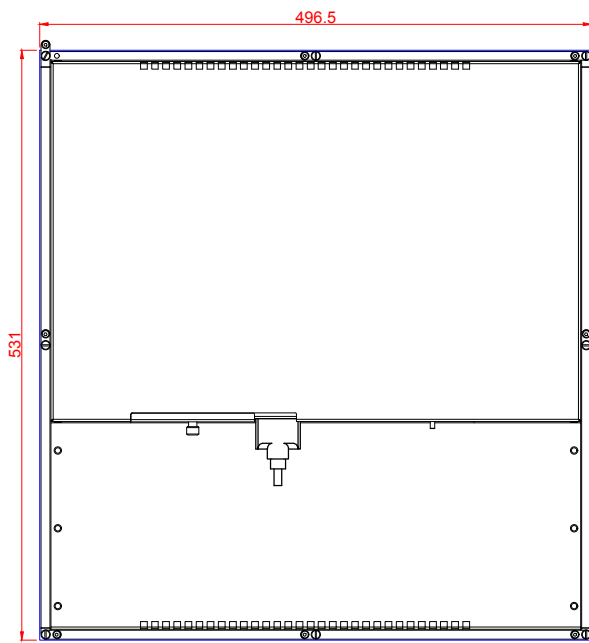

cut out dimensions: 531mm x 496,5mm

rear view

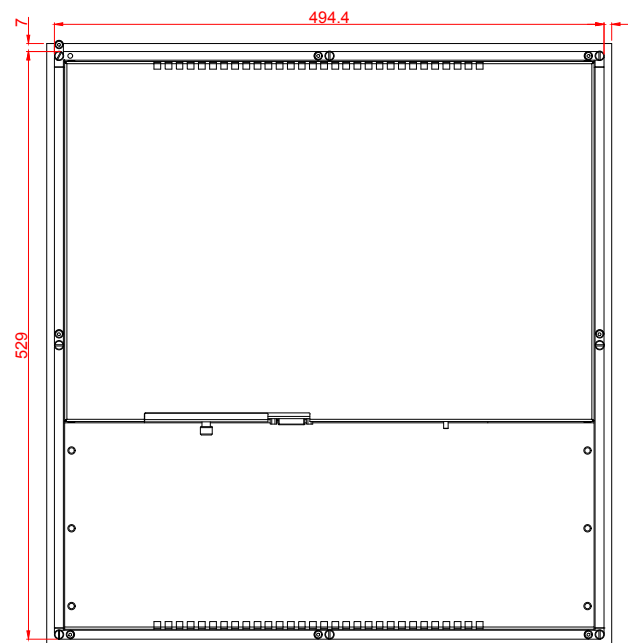

rear view

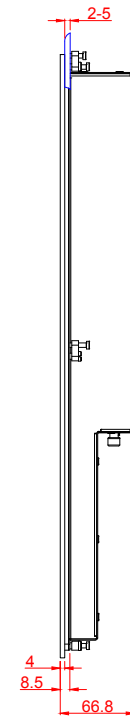

left view

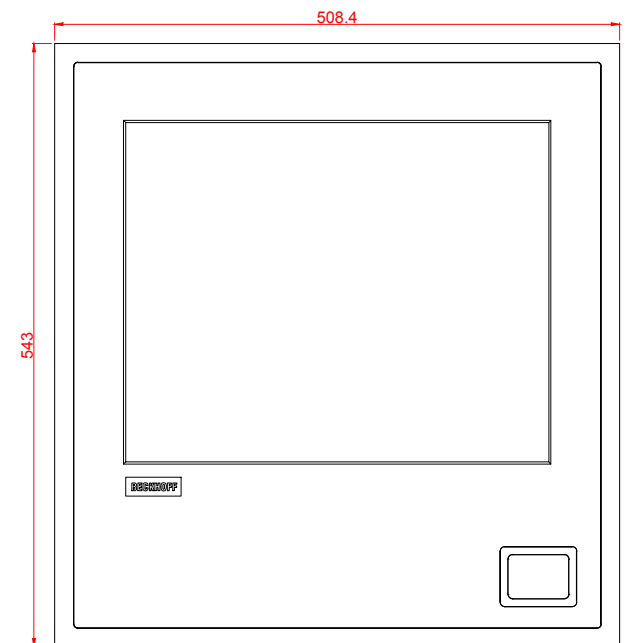

front view