

CP6601-0000

main dimensions an  
fixing points

main dimensions

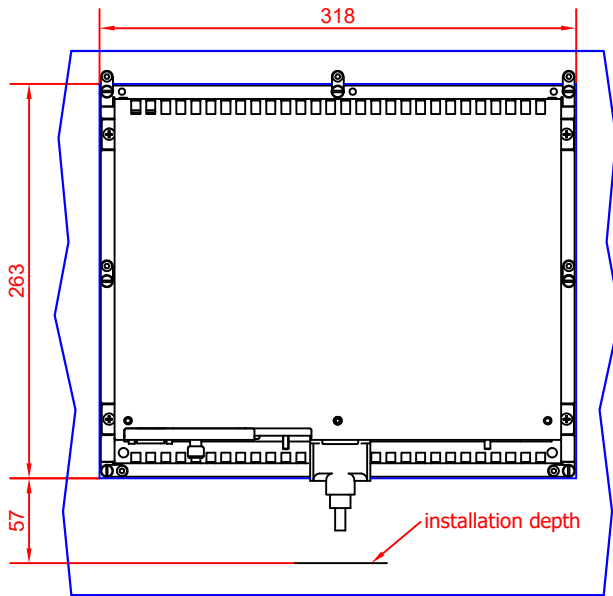

cut out dimension: 263mm x 318mm

rear view

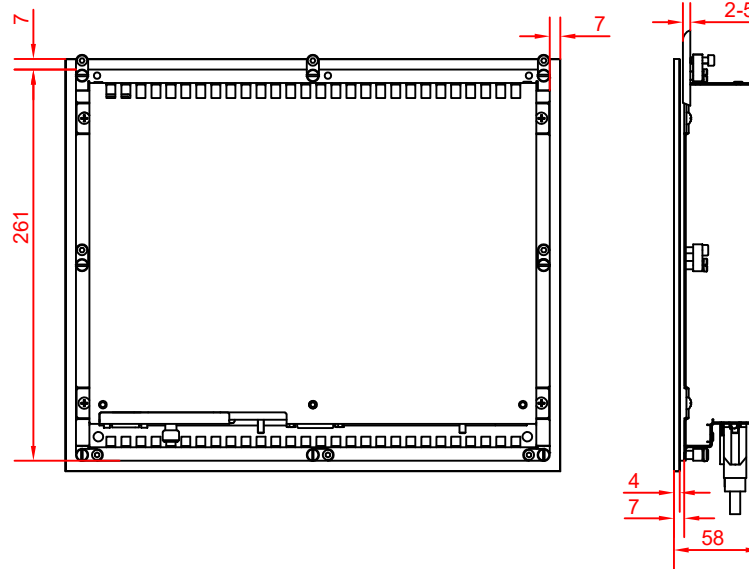

rear view

side view

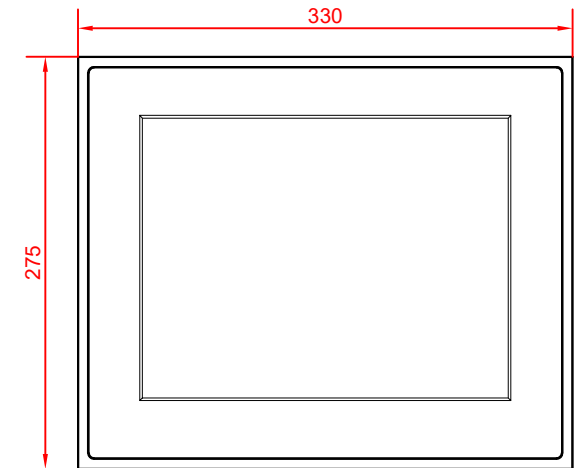

front view

