

CP3219-M184-E281-M406

main dimensions and
fixing points

dimensions in mm

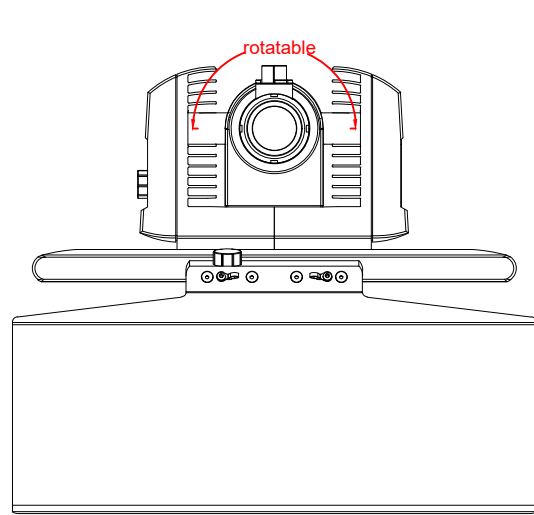

bottom view

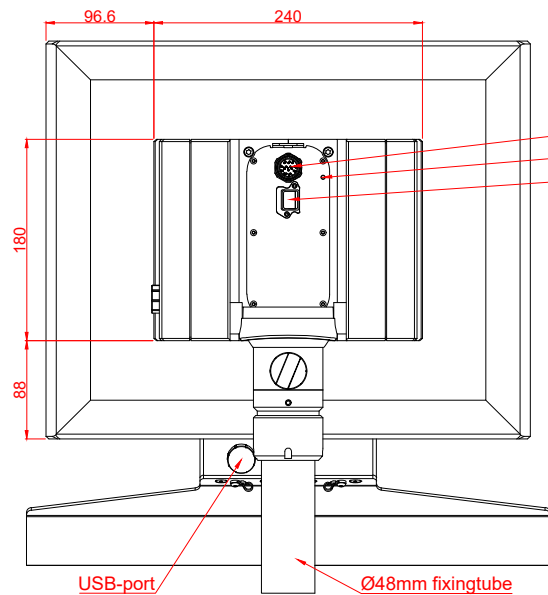
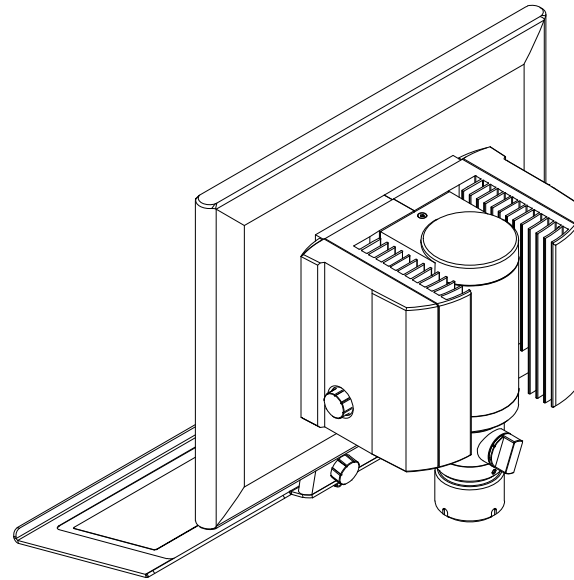

rear view

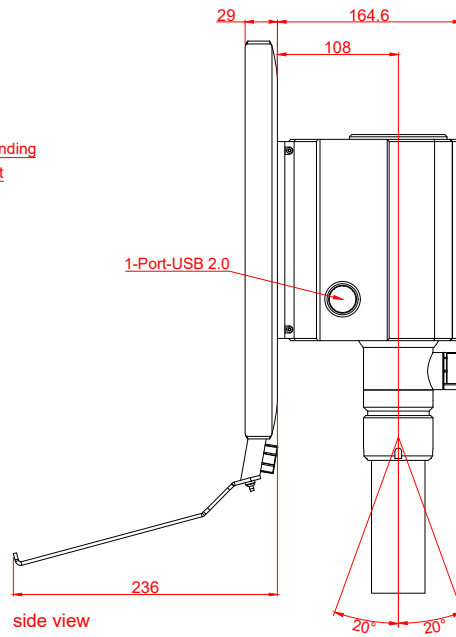

side view

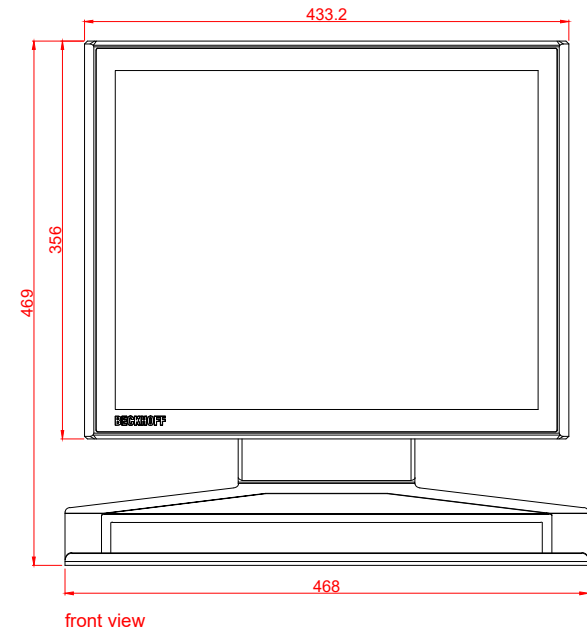

front view