

# CP3218-M184

main dimensions and  
fixing points

dimensions in mm

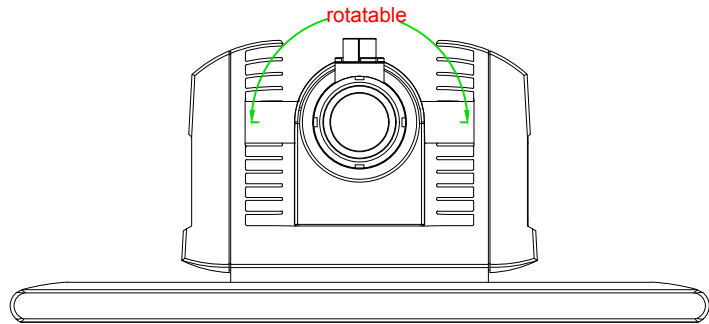

bottom view

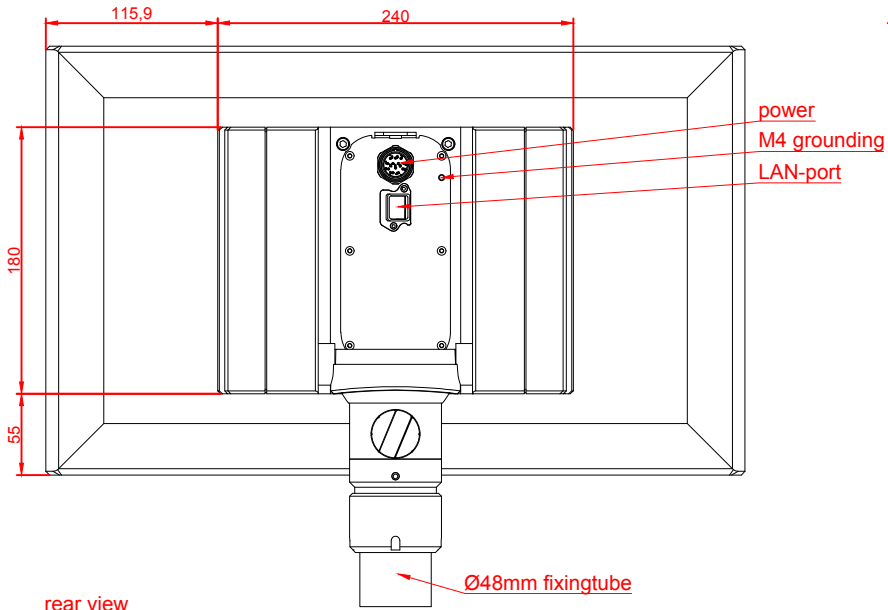
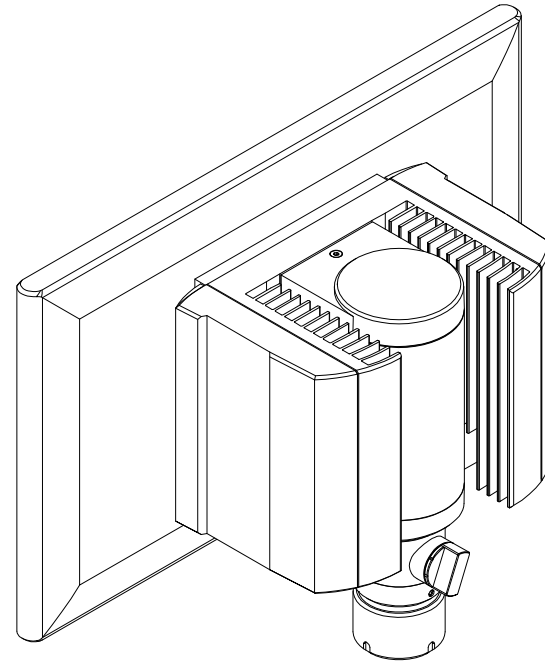

rear view

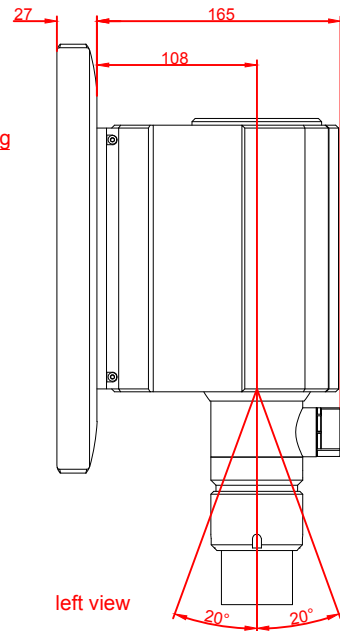

left view

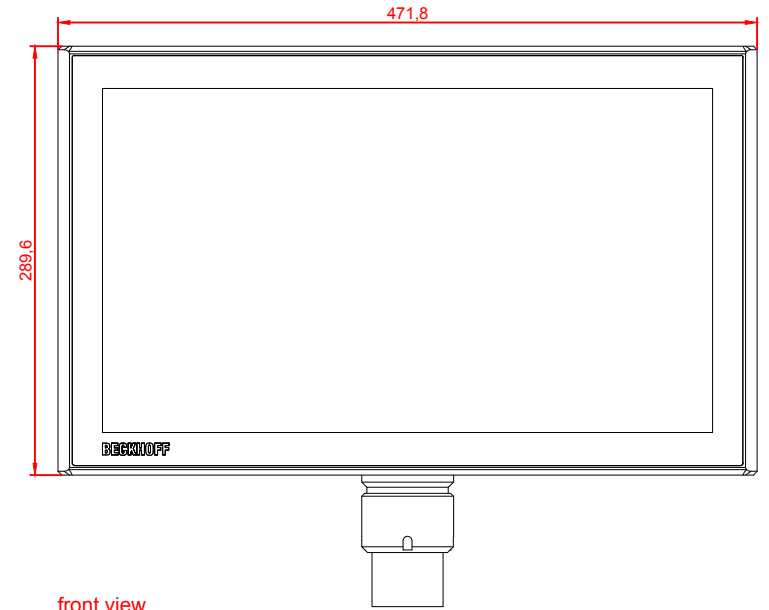

front view