

CP2715

main dimensions and
fixing points

dimensions in mm

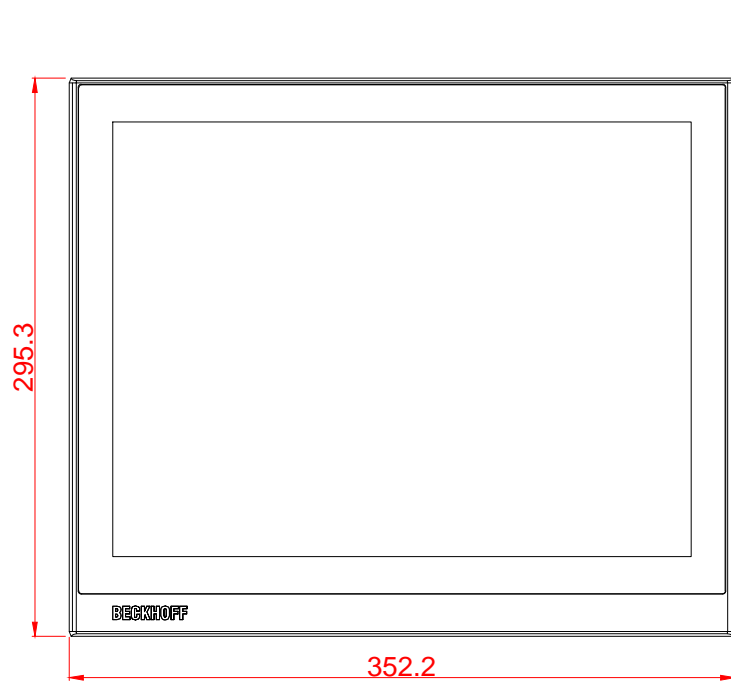

front view

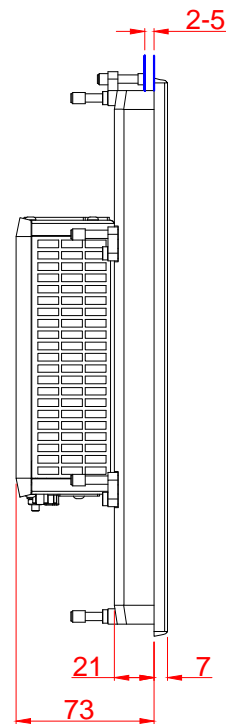

left view

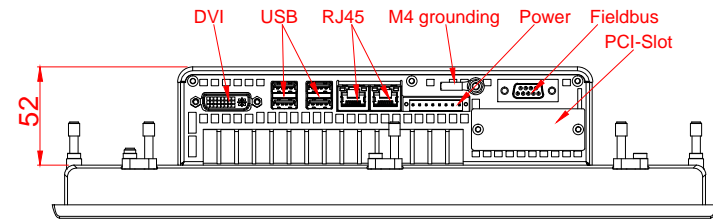

bottom view

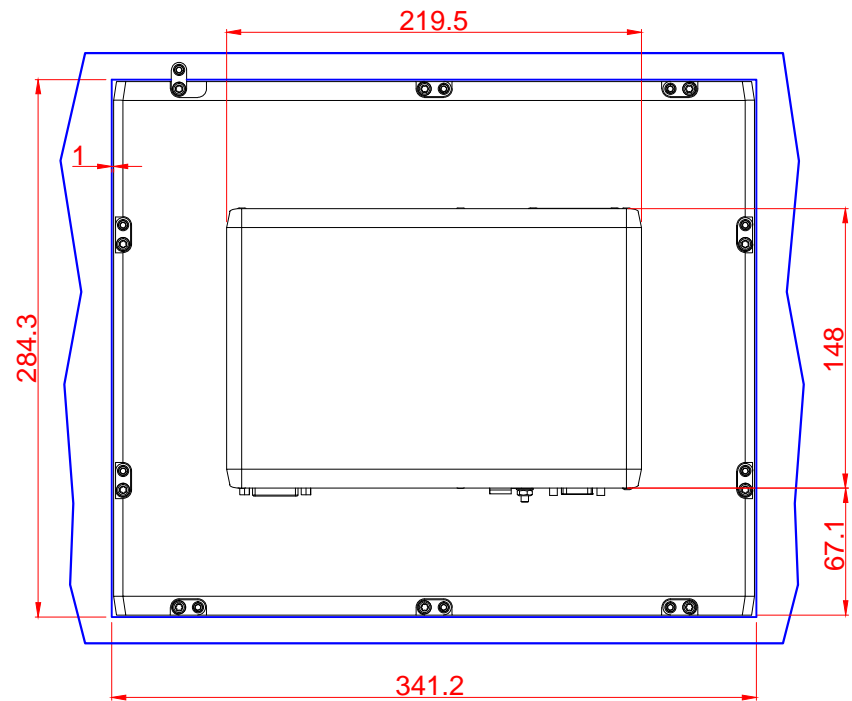

cut out dimensions: 284.3mm x 341.2mm

rear view

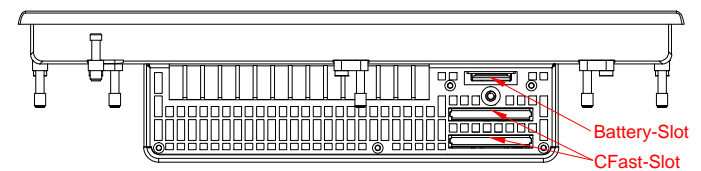

top view