

CP2211-0010  
 main dimensions and  
 fixing points  
 dimensions in mm

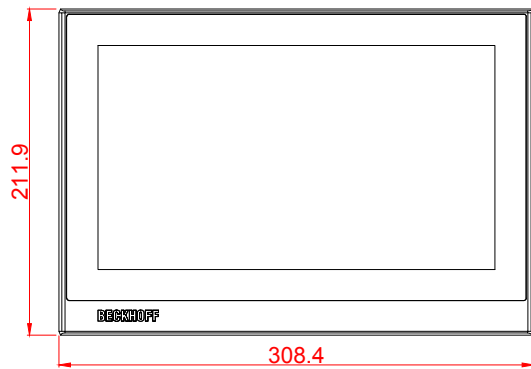

front view

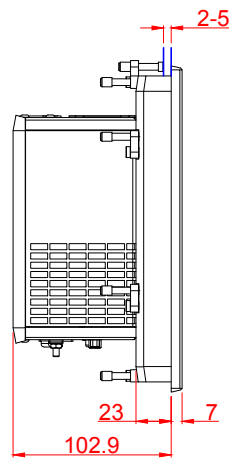

left view

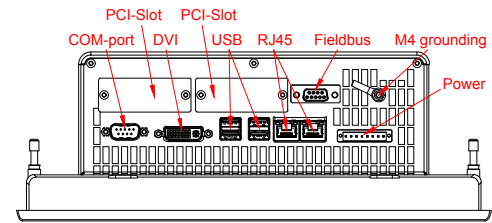

bottom view

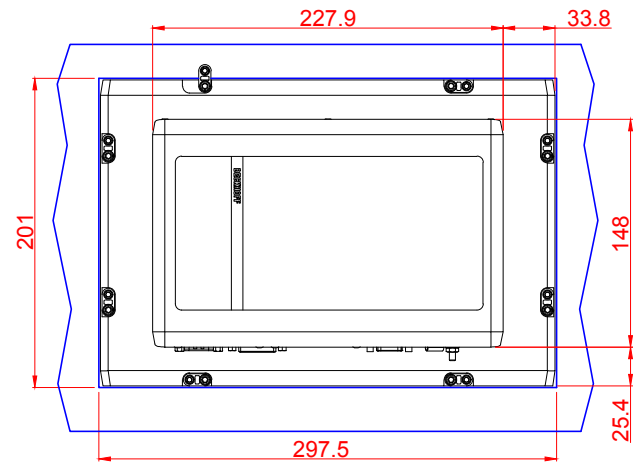

cut out dimensions: 201mm x 297,5mm

rear view

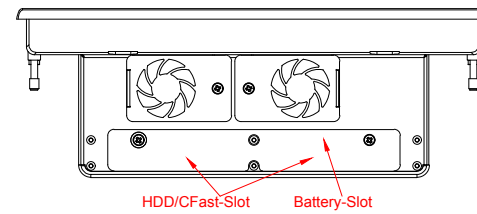

top view