

CP7912-0000-E756
 arm adapter for
 Rolec - Tara - suspension adaption
 146.025.019

main dimensions and
 fixing points

dimensions in mm

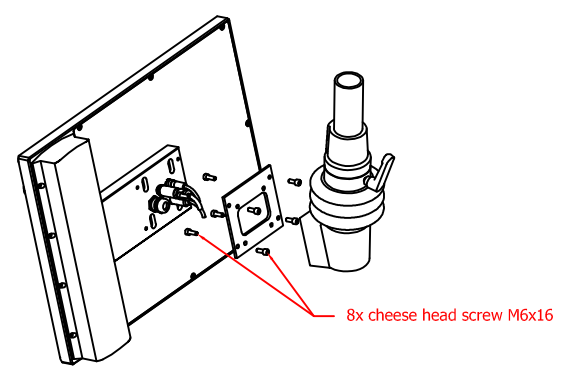

149.025.014