

bottom view

front view

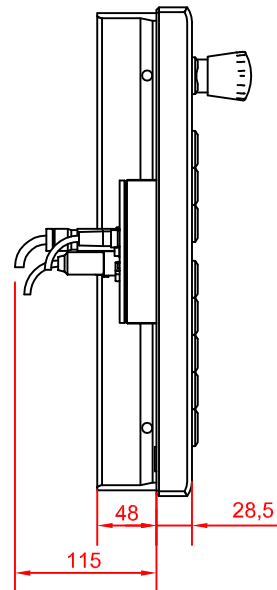

left view

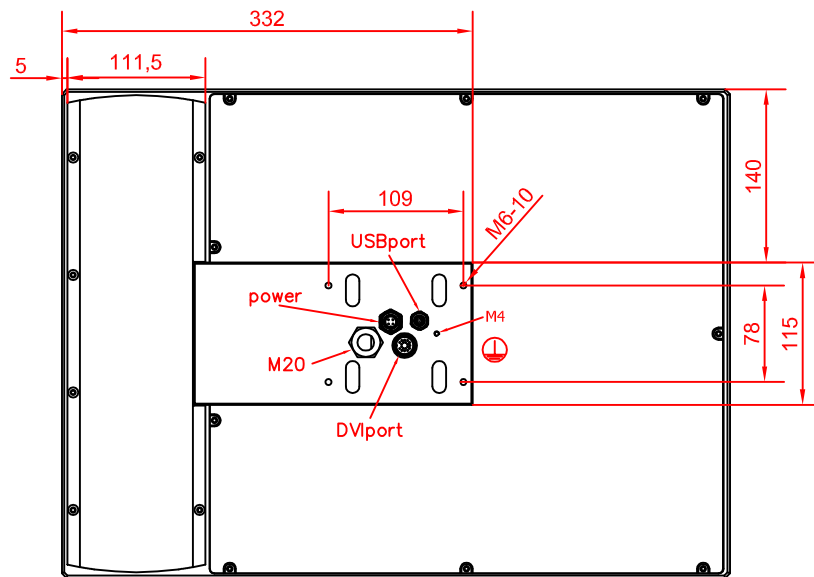

rear view

CP7902-0000-E746
 arm adapter for
 Rolec - Tara - suspension adaption
 146.025.019

main dimensions and
 fixing points

dimensions in mm

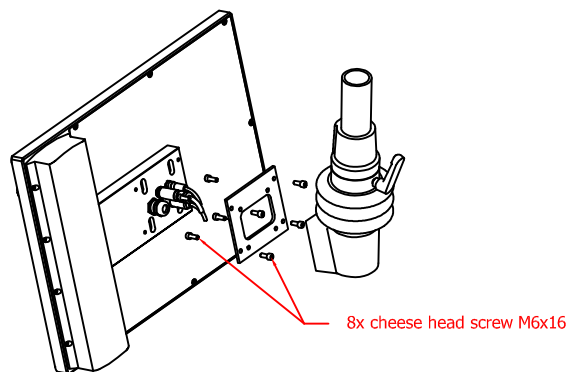

149.025.014