

bottom view

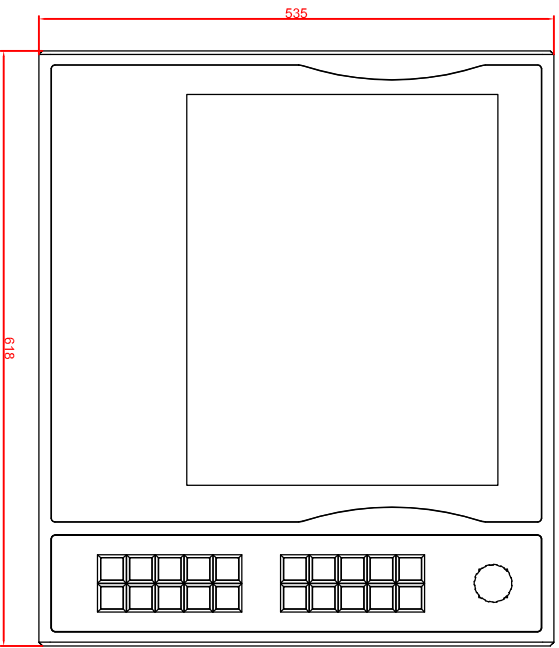

front view

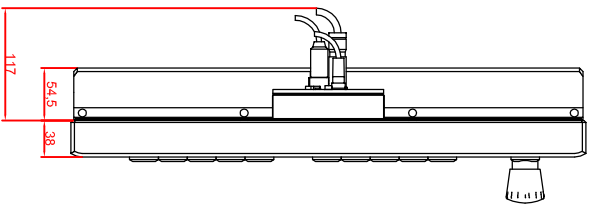

left view

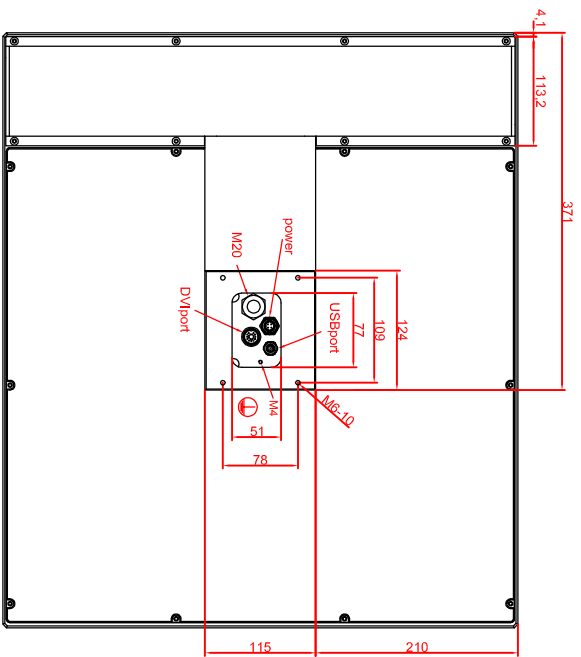

rear view

CP7833-0001-E799
 arm adapter for
 Roloc - Tara Plus -
 suspension adaption
 main dimensions and
 fixing points
 dimensions in mm

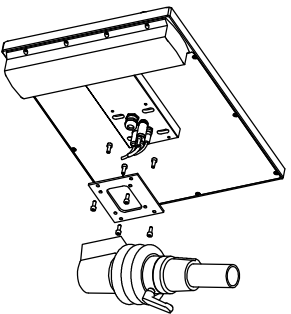

149.025.014

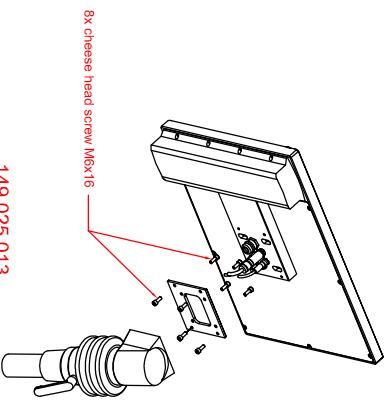

149.025.013