

bottom view

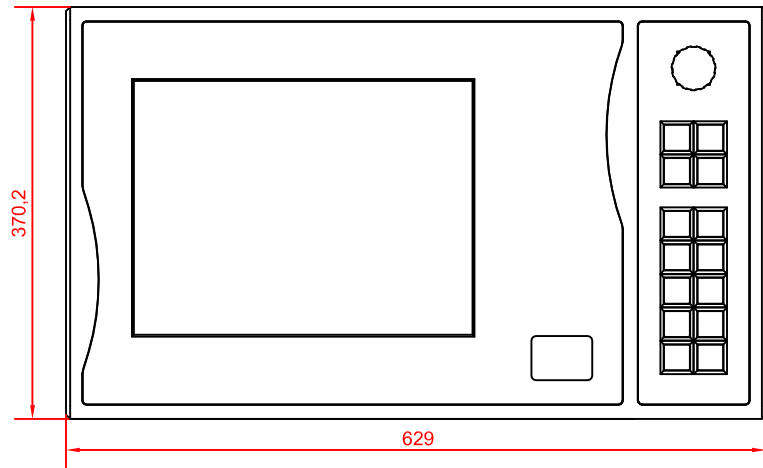

front view

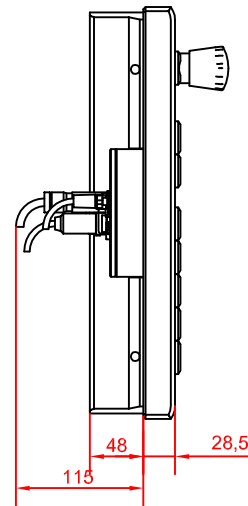

left view

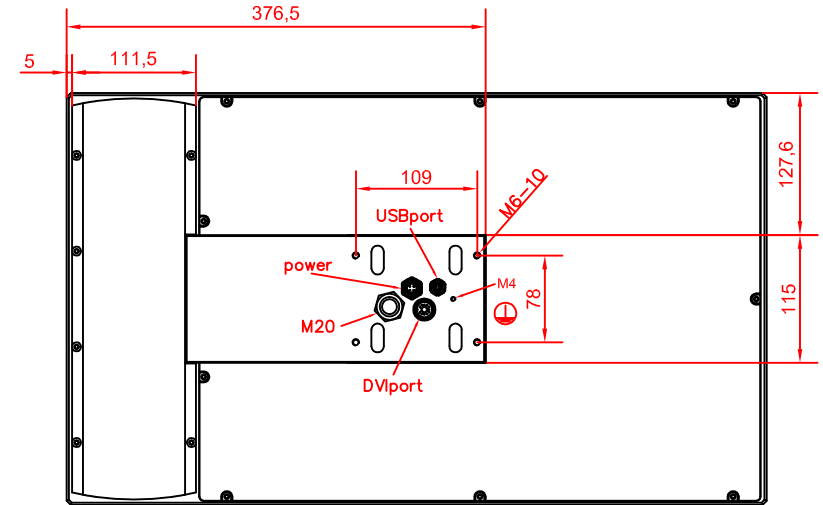

rear view

CP7822-0002-E768
arm adapter for
Rolec - Tara - suspension adaption
146.025.019

main dimensions and
fixing points

dimensions in mm

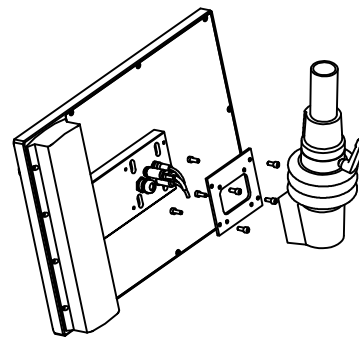

149.025.014

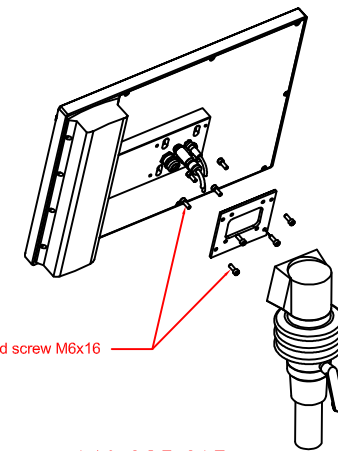

8x cheese head screw M6x16

149.025.013