

front view

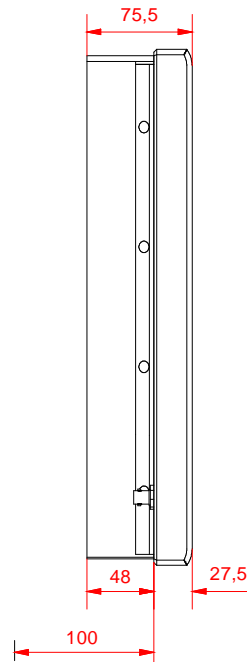

installation depth  
cp-link connectors

left view

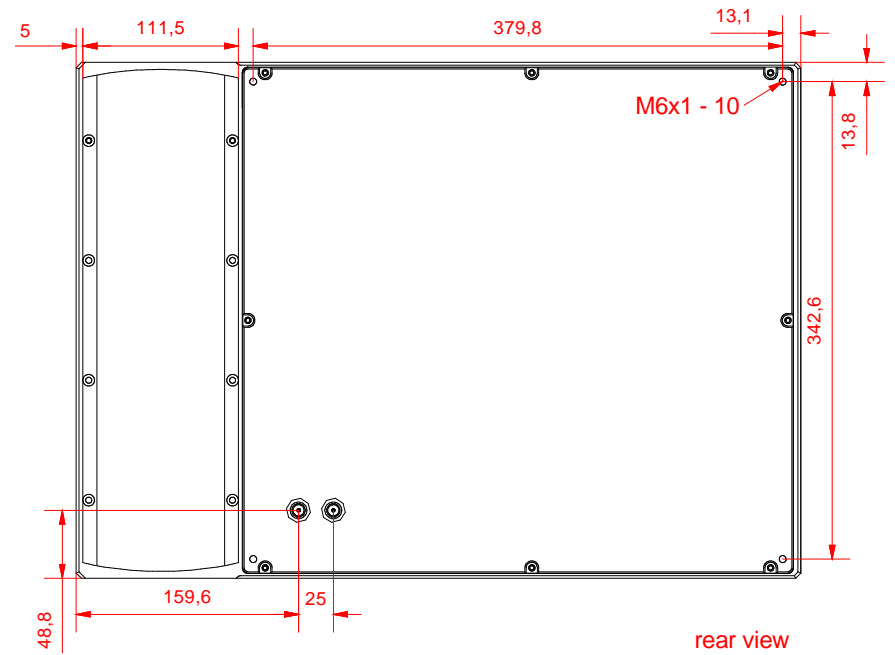

rear view

CP 7031 - 0001 - E611

main dimensions and  
fixing points

dimensions in mm

