

installation depth
cp-link connectors

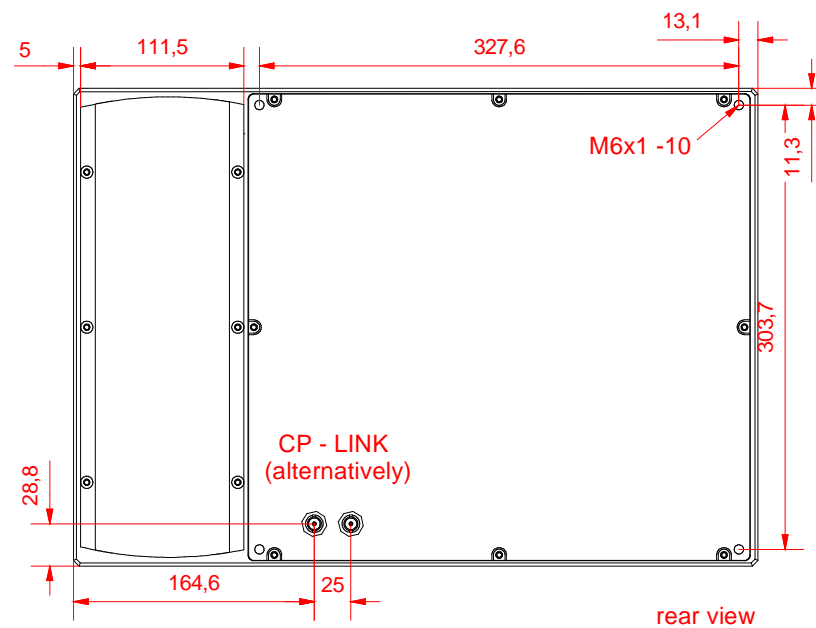

CP 7011 - 0000 - E601

main dimensions and
fixing points

dimensions in mm

