

bottom view

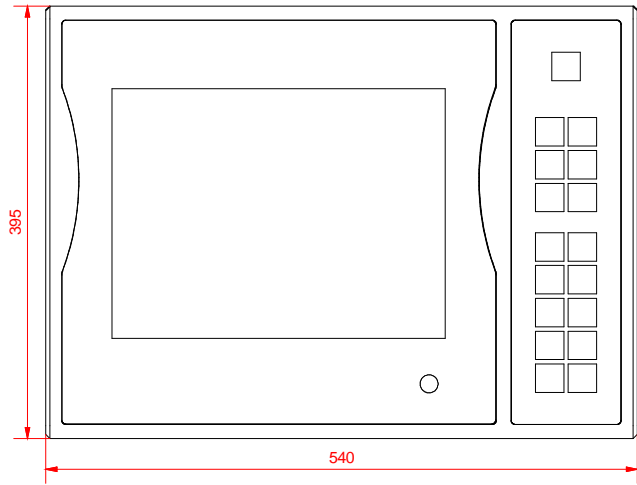

front view

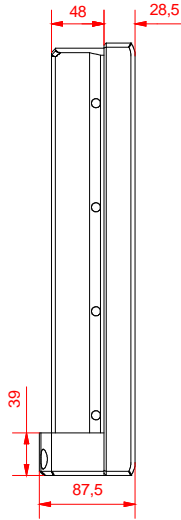

left view

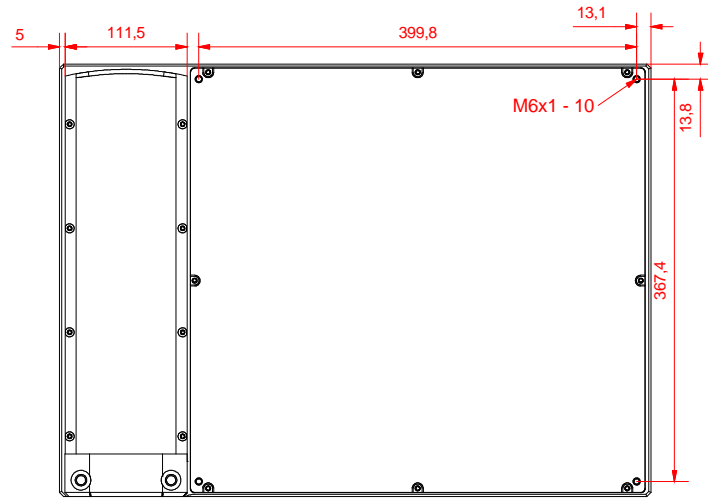

rear view

CP7002 - 0011 - E647

arm adapter for
Rolec - Tara - suspension adaption
146.025.019

main dimensions and
fixing points

dimensions in mm

