

CP3921-0000  
with  
C9900-M575

main dimensions and  
fixing points

dimensions in mm

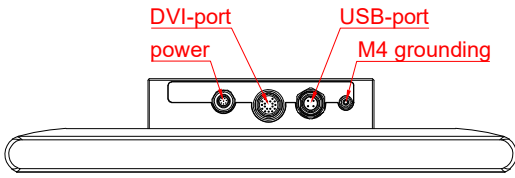
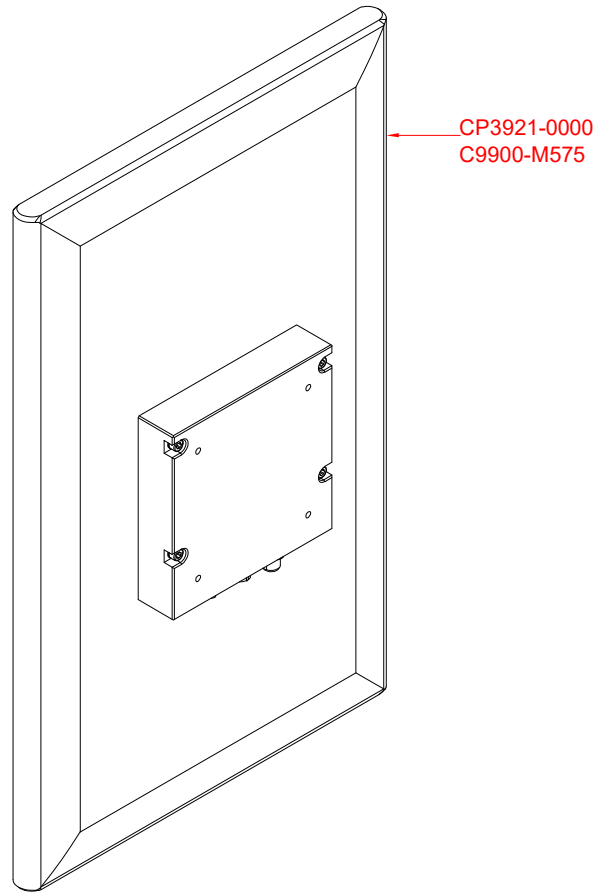

bottom view

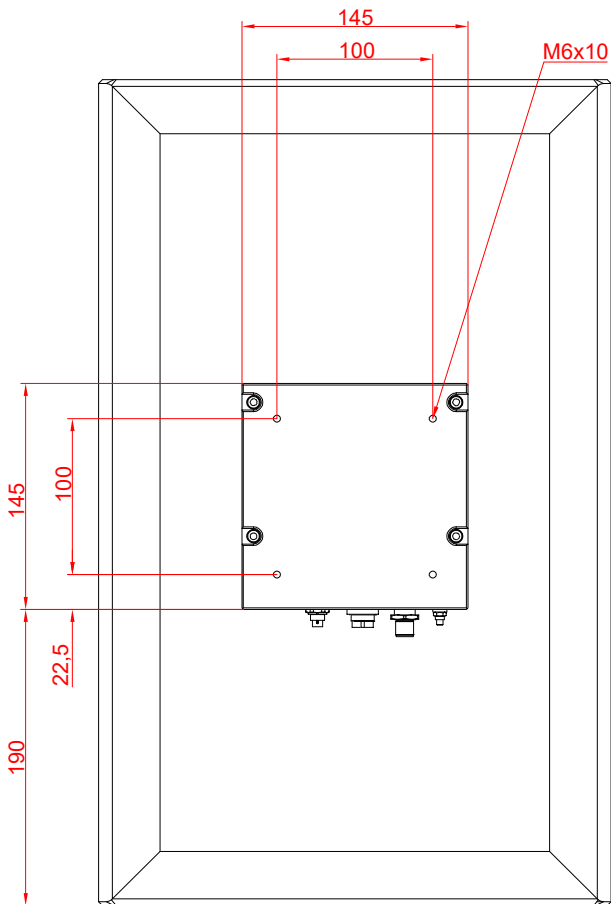

rear view

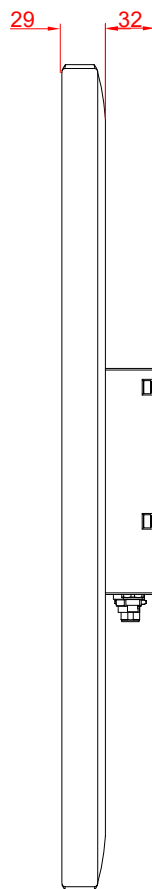

side view

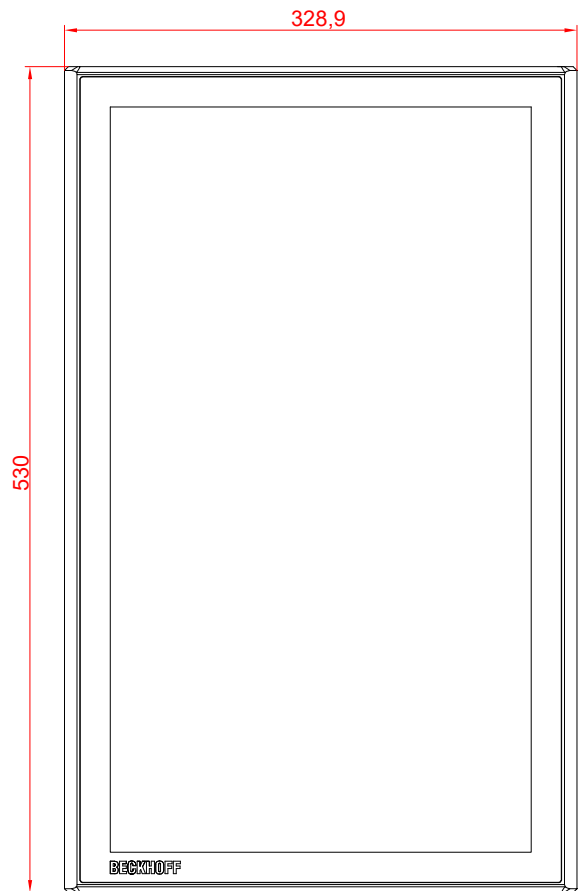

front view