

bottom view

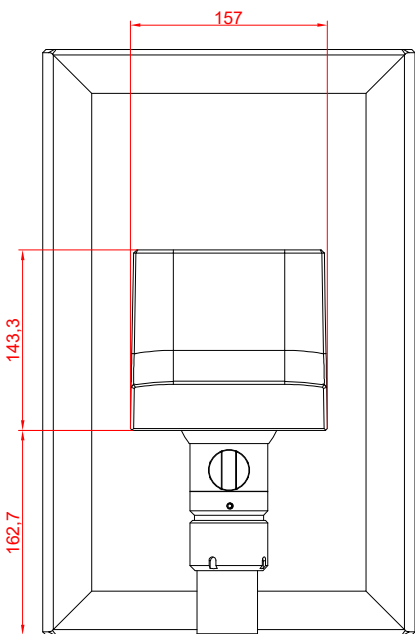

rear view

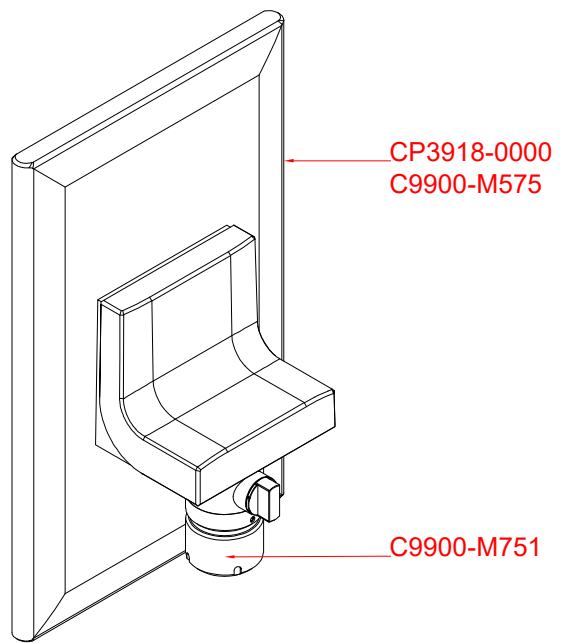
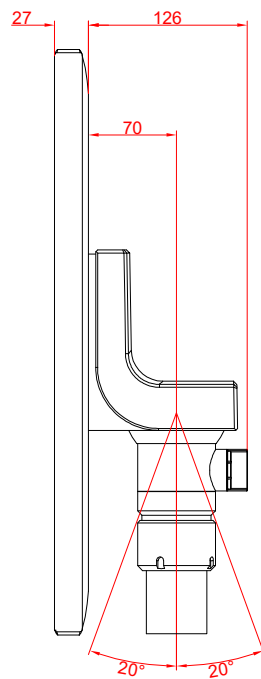

side view

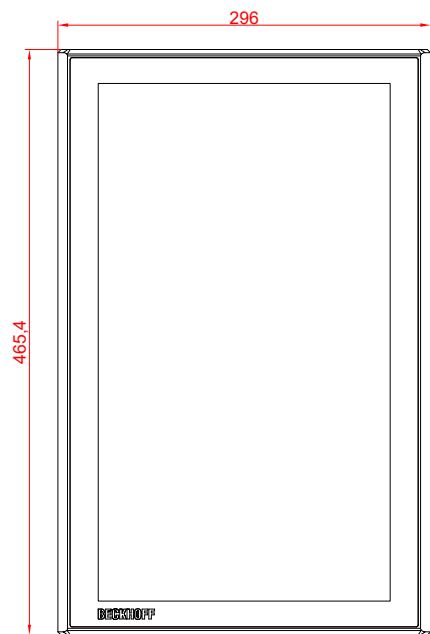

front view

CP3918-0000  
with  
C9900-M575  
C9900-M751

main dimensions and  
fixing points

dimensions in mm

