

CP3918-0000
with
C9900-M575

main dimensions and
fixing points

dimensions in mm

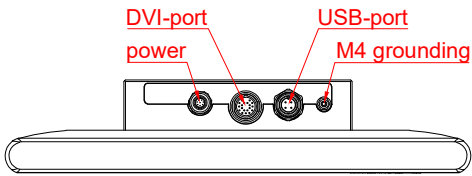
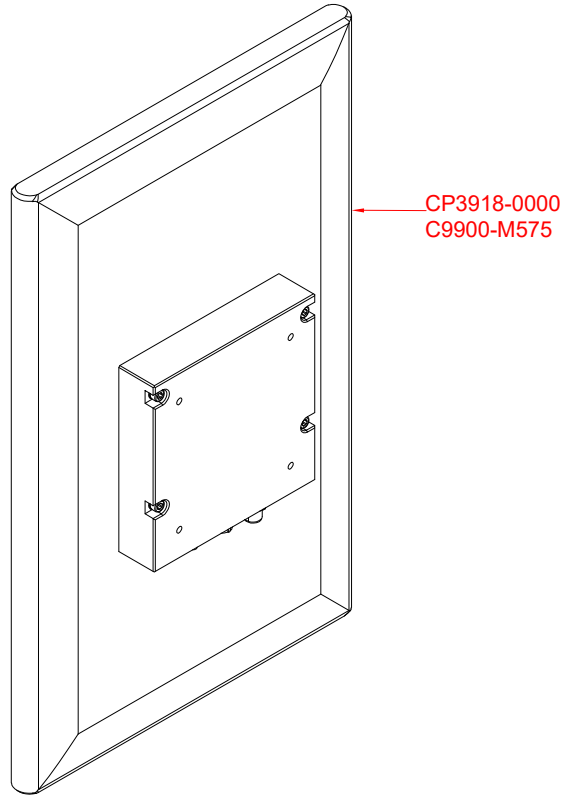

bottom view

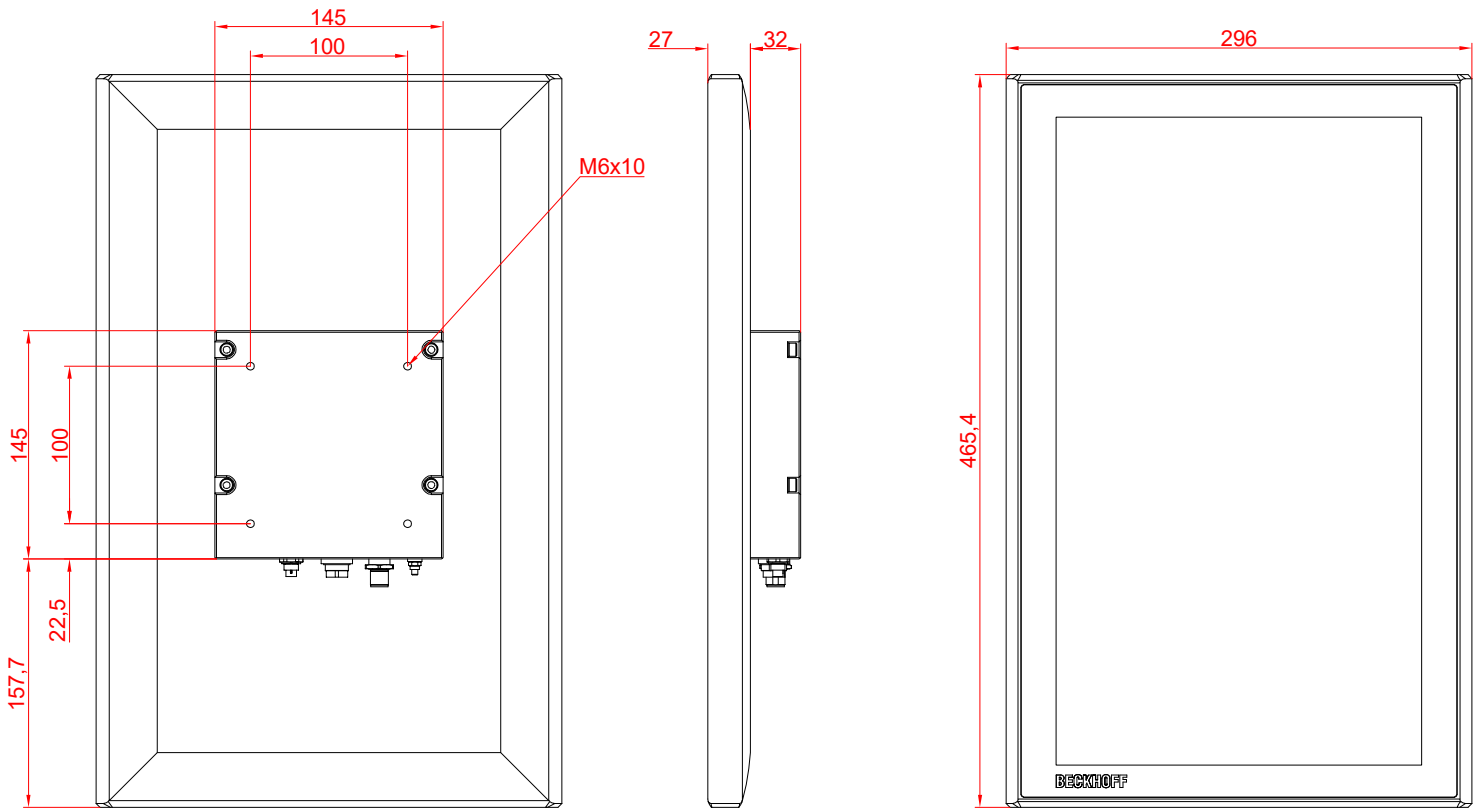

rear view

side view

front view