

bottom view

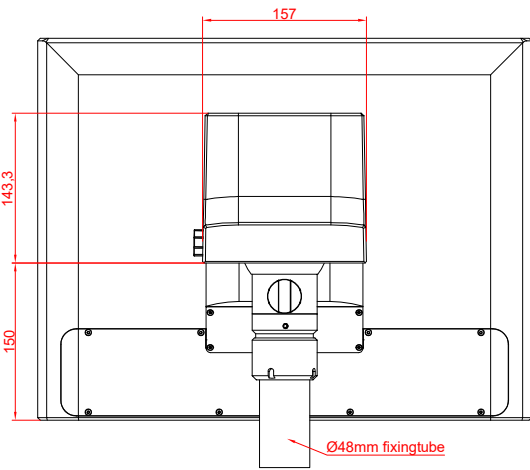

rear view

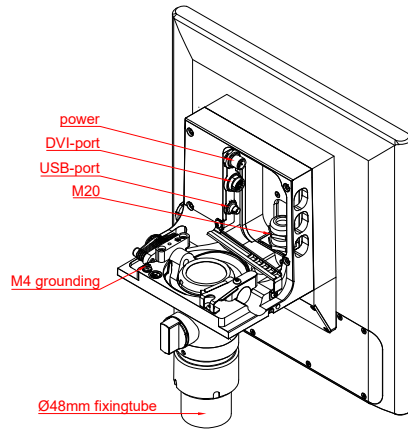
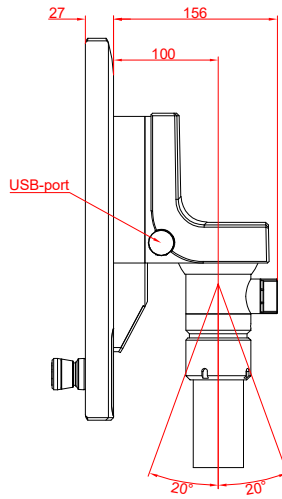

side view

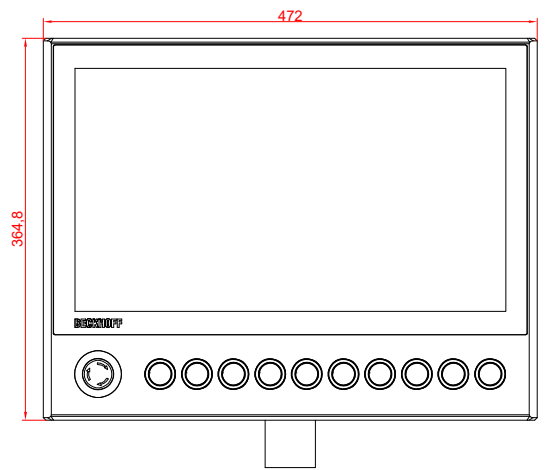

front view

CP3918-0000
with
C9900-G025
C9900-M753
C9900-E274

main dimensions and
fixing points

dimensions in mm

