

front view

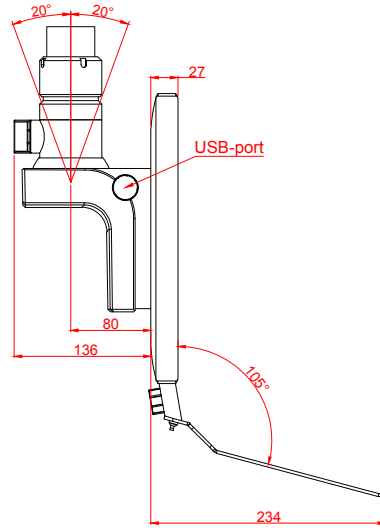

left view

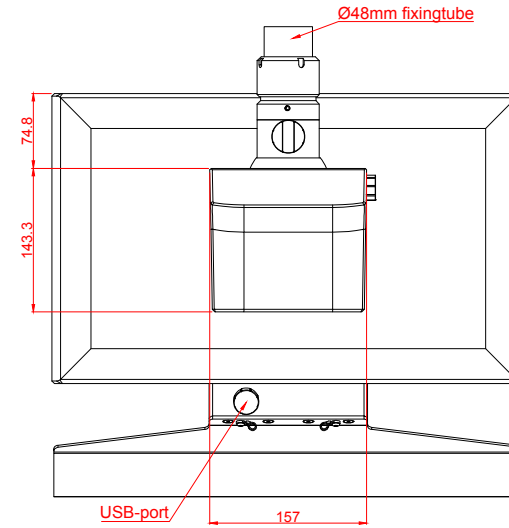

rear view

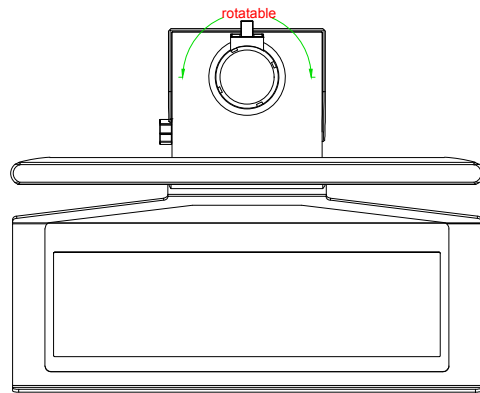

top view

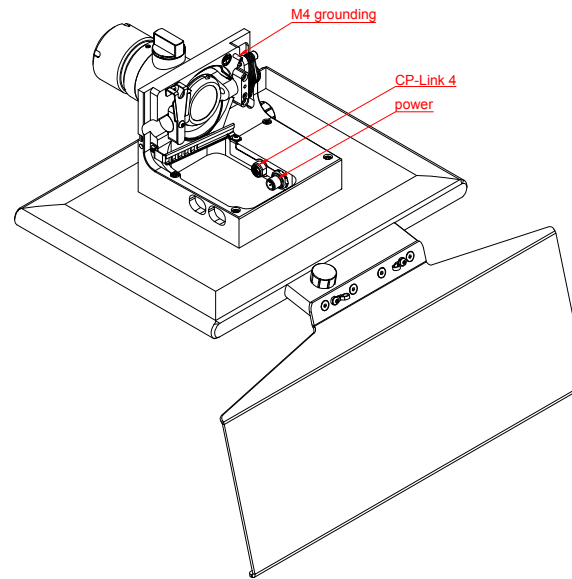

CP3918-0010-M750-E274-M406

main dimensions and
fixing points

dimensions in mm