

CP3915-0010-E274

main dimensions and
fixing points

dimensions in mm

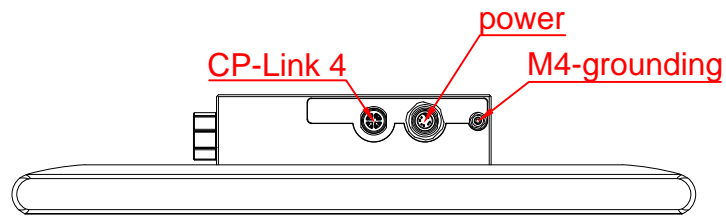

bottom view

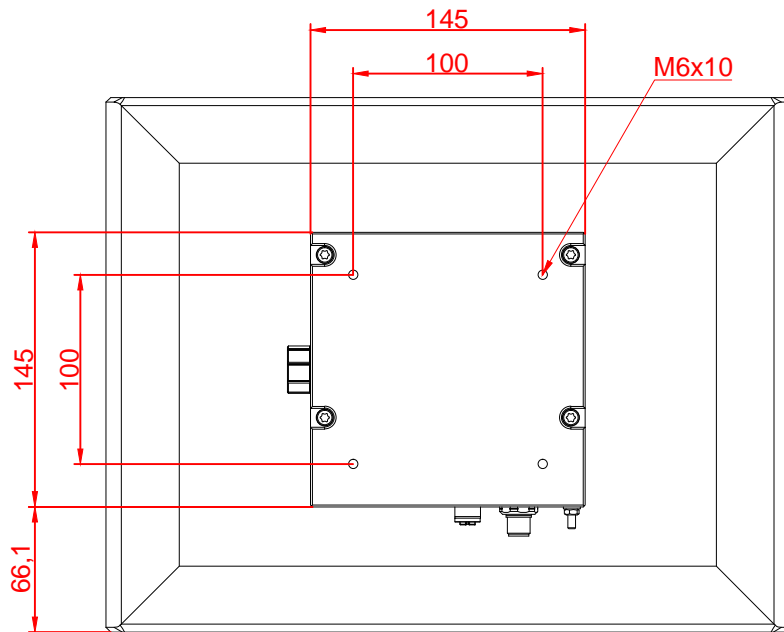
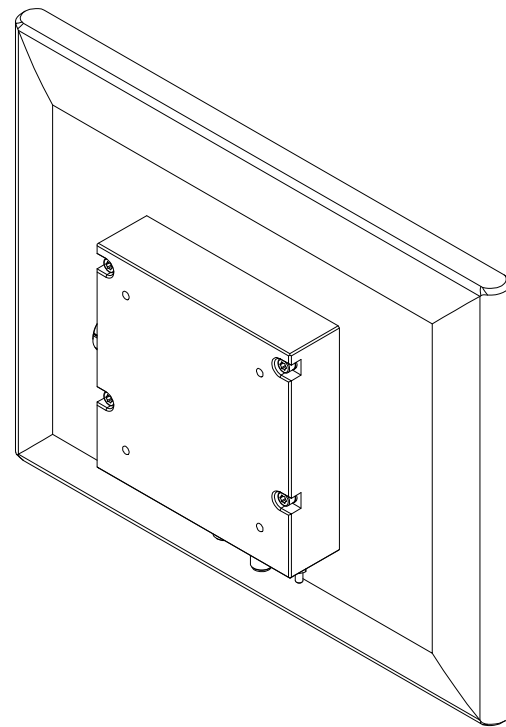

rear view

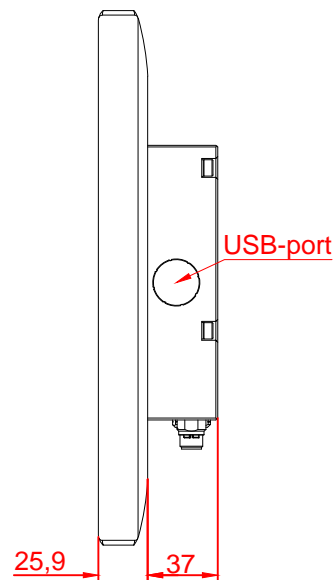

left view

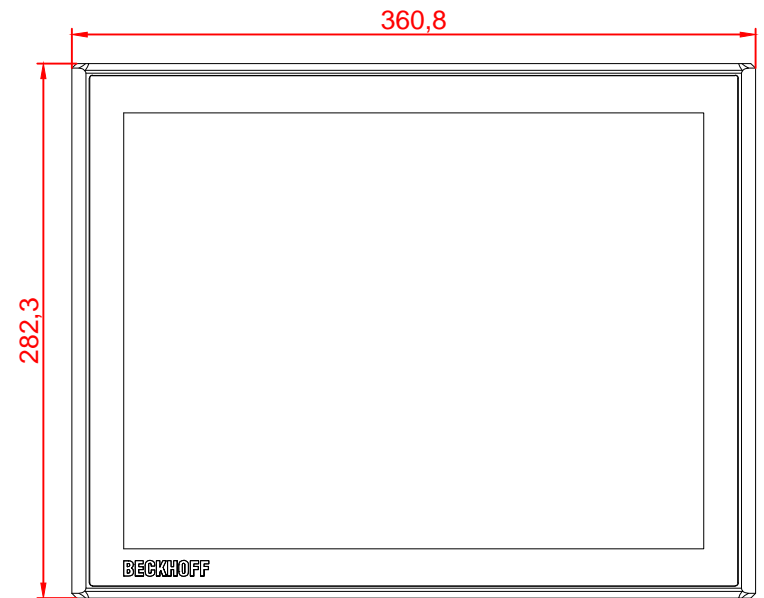

front view