

CP3913-0000  
with  
C9900-M390

main dimensions and  
fixing points

dimensions in mm

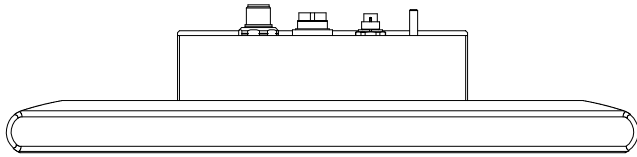

bottom view

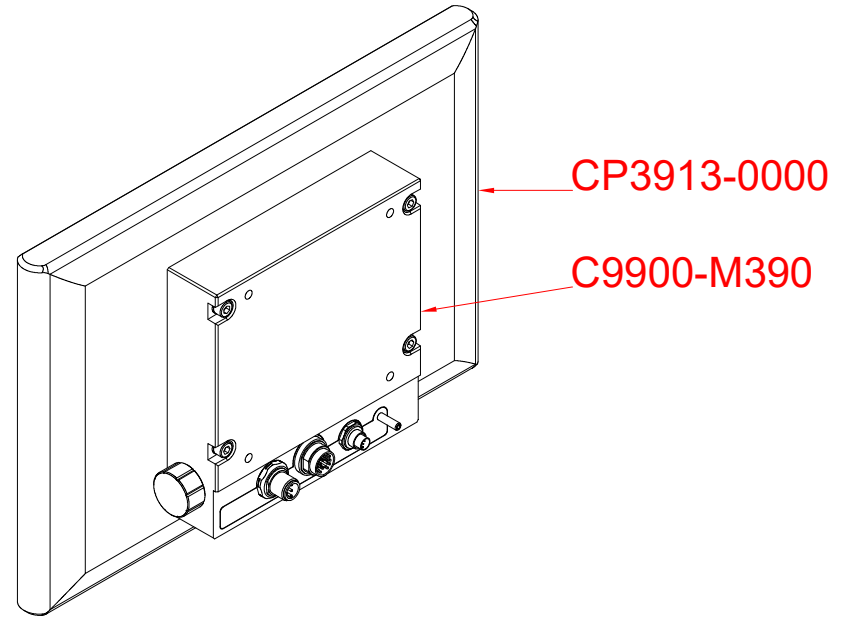

CP3913-0000

C9900-M390

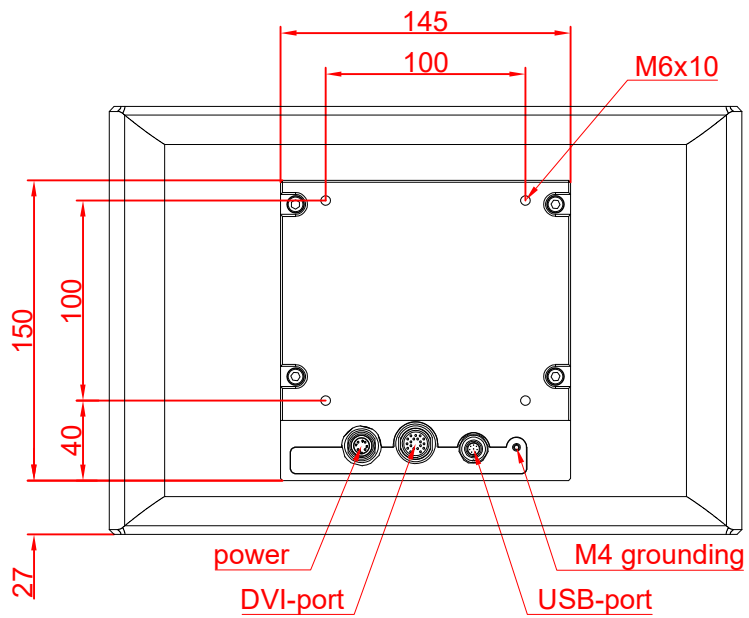

rear view

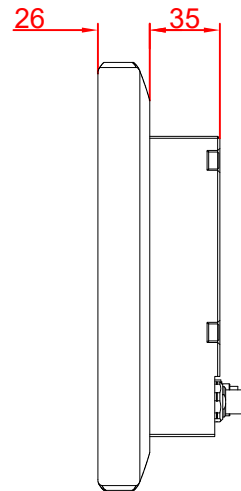

side view

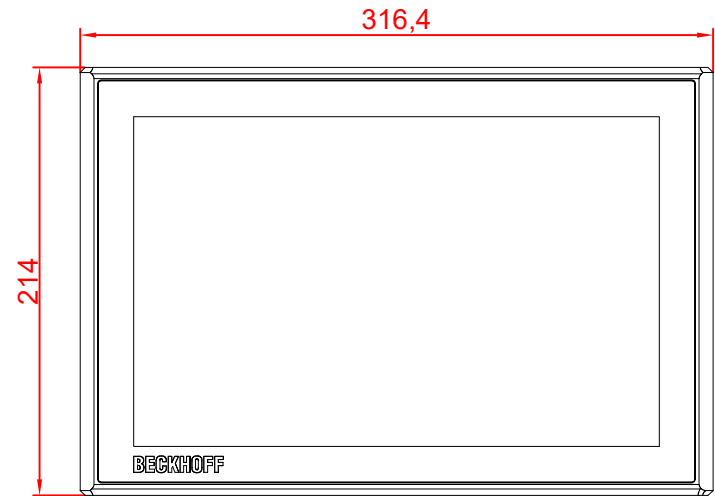

front view