

CP3912-0000
with
C9900-G022

main dimensions and
fixing points

dimensions in mm

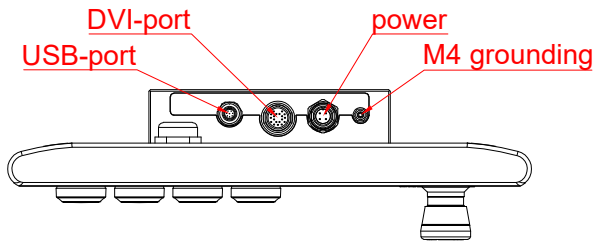

bottom view

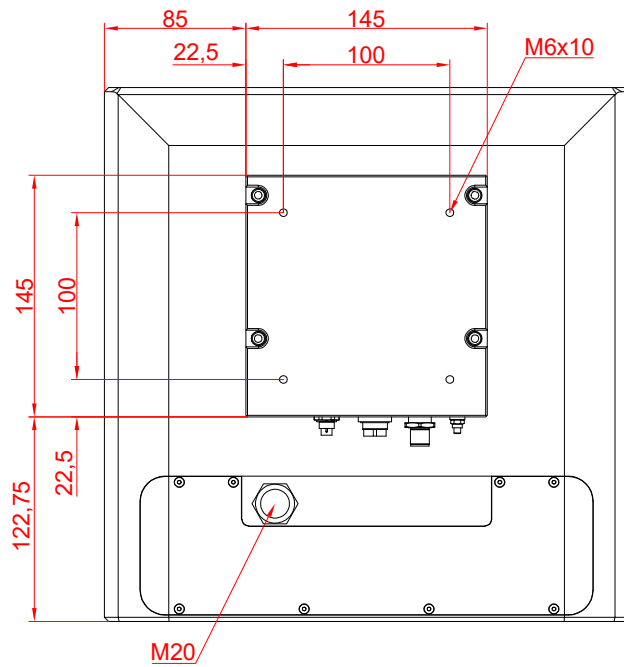
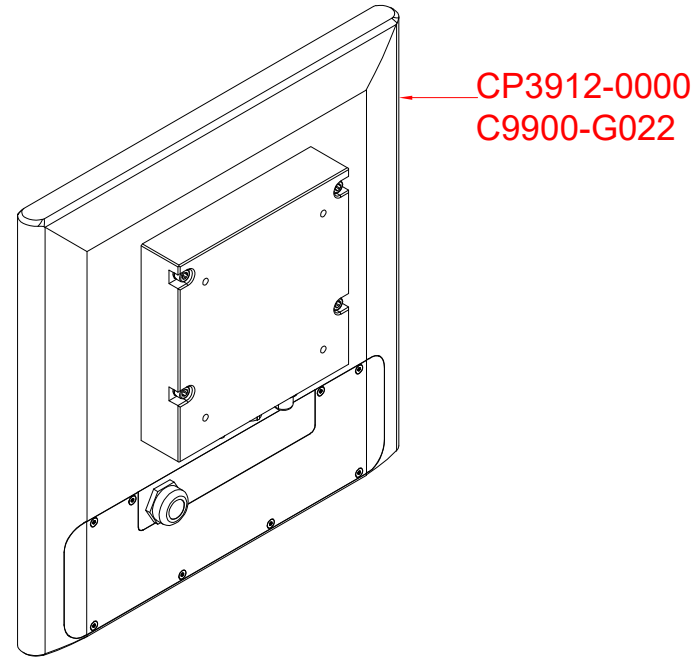

rear view

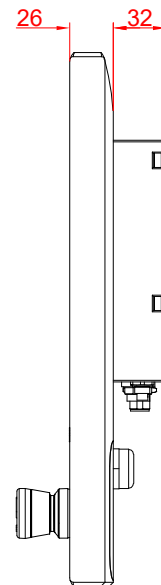

side view

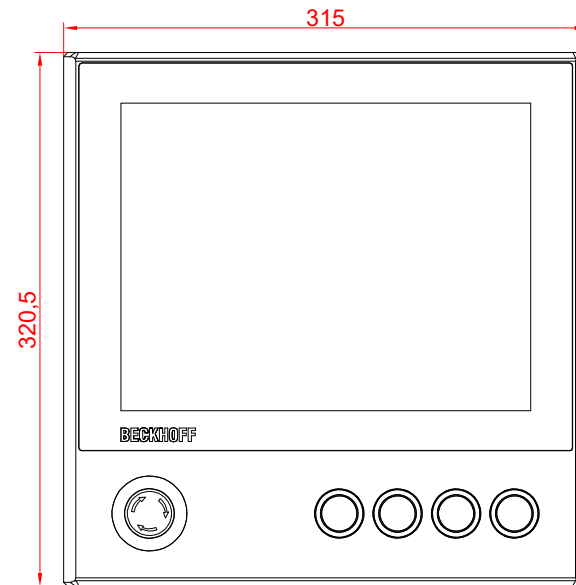

front view