



Installation- and Operating instructions for

# CU8810-0000

DVI Splitter for CP69xx and CP79xx

Version: 1.2

Date: 2016-01-21

**BECKHOFF**



# Table of contents

<b>1</b>	<b>Foreword</b>	<b>3</b>
1.1	Notes on the Documentation	3
1.1.1	Liability Conditions	3
1.1.2	Trademarks	3
1.1.3	Patent Pending	3
1.1.4	Copyright	3
1.1.5	State at Delivery	3
1.1.6	Delivery conditions	3
1.2	Description of safety symbols	4
1.3	Operator's obligation to exercise diligence	4
<b>2</b>	<b>Product Description</b>	<b>5</b>
2.1	Product Overview	5
2.2	Connections	6
2.2.1	Power Supply (X10)	6
2.2.2	Data Connectors	6
2.3	LED-Diagnostics	8
<b>3</b>	<b>Installation</b>	<b>9</b>
3.1	Transport and Unpacking	9
3.1.1	Transport	9
3.1.2	Unpacking	9
3.2	Mounting / Unmounting	10
3.2.1	Mounting the DVI Splitter	10
3.2.2	Unmounting the DVI Splitter	10
3.3	Connecting devices	11
3.3.1	Connecting cables	11
3.3.2	Connecting Power Supply	11
<b>4</b>	<b>Operation</b>	<b>12</b>
4.1	Configuration	12
4.1.1	Opening the enclosure	12
4.1.2	DIP Switch 1 (SW1)	13
4.1.3	DIP Switch 2 (SW2)	15
4.1.4	DIP-Switch 3 (SW3)	16
4.2	Architecture Description	18
4.2.1	Version 1	18
4.2.2	Version 2	18
4.2.3	Version 3	18

---

4.2.4	Version 4	19
4.3	Maintenance	20
4.3.1	Cleaning	20
4.3.2	Maintenance	20
4.4	Shutting down	20
4.4.1	Disposal	20
5	Dimensions	21
6	Technical Data	22
7	Appendix	23
7.1	Beckhoff Support and Service	23
7.1.1	Beckhoff branches and partner companies	23
7.1.2	Beckhoff company headquarters	23
7.2	Approvals for USA and Canada	24
7.3	FCC Approval for USA	24
7.4	FCC Approval for Canada	24

# 1 Foreword

## 1.1 Notes on the Documentation

This description is only intended for the use of trained specialists in control and automation engineering who are familiar with the applicable national standards. It is essential that the following notes and explanations are followed when installing and commissioning these components.

The responsible staff must ensure that the application or use of the products described satisfy all the requirements for safety, including all the relevant laws, regulations, guidelines and standards.

### 1.1.1 Liability Conditions

The documentation has been prepared with care. The products described are, however, constantly under development. For that reason the documentation is not in every case checked for consistency with performance data, standards or other characteristics. In the event that it contains technical or editorial errors, we retain the right to make alterations at any time and without warning. No claims for the modification of products that have already been supplied may be made on the basis of the data, diagrams and descriptions in this documentation.

All pictures shown in the documentation are exemplary. Illustrated configurations can differ from standard.

### 1.1.2 Trademarks

Beckhoff®, TwinCAT®, EtherCAT®, Safety over EtherCAT®, TwinSAFE® and XFC® are registered trademarks of and licensed by Beckhoff Automation GmbH.

Other designations used in this publication may be trademarks whose use by third parties for their own purposes could violate the rights of the owners.

### 1.1.3 Patent Pending

The EtherCAT Technology is covered, including but not limited to the following patent applications and patents: EP1590927, EP1789857, DE102004044764, DE102007017835 with corresponding applications or registrations in various other countries.

The TwinCAT Technology is covered, including but not limited to the following patent applications and patents: EP0851348, US6167425 with corresponding applications or registrations in various other countries.

### 1.1.4 Copyright

© Beckhoff Automation GmbH & Co. KG.

The reproduction, distribution and utilization of this document as well as the communication of its contents to others without express authorization are prohibited. Offenders will be held liable for the payment of damages. All rights reserved in the event of the grant of a patent, utility model or design.

### 1.1.5 State at Delivery





All the components are supplied in particular hardware and software configurations appropriate for the application. Modifications to hardware or software configurations other than those described in the documentation are not permitted, and nullify the liability of Beckhoff Automation GmbH & Co. KG.

### 1.1.6 Delivery conditions

In addition, the general delivery conditions of the company Beckhoff Automation GmbH & Co. KG apply.

## 1.2 Description of safety symbols

The following safety symbols are used in this operating manual. They are intended to alert the reader to the associated safety instructions.

 <b>DANGER</b>	<p><b>Acute risk of injury!</b></p> <p>If you <b>do not</b> adhere the safety advise adjoining this symbol, there is immediate danger to life and health of individuals!</p>
 <b>WARNING</b>	<p><b>Risk of injury!</b></p> <p>If you <b>do not</b> adhere the safety advise adjoining this symbol, there is danger to life and health of individuals!</p>
 <b>CAUTION</b>	<p><b>Hazard to individuals!</b></p> <p>If you <b>do not</b> adhere the safety advise adjoining this symbol, there is obvious hazard to individuals!</p>
 <b>Attention</b>	<p><b>Hazard to devices and environment</b></p> <p>If you <b>do not</b> adhere the notice adjoining this symbol, there is obvious hazard to materials and environment.</p>
 <b>Note</b>	<p><b>Note or pointer</b></p> <p>This symbol indicates information that contributes to better understanding.</p>

## 1.3 Operator's obligation to exercise diligence

The operator must ensure that

- the product is only used as intended (see chapter [Product Description](#))
- the product is in a sound condition and in working order during operation (see chapter [Maintenance](#))
- the product is operated, maintained and repaired only by suitably qualified and authorized personnel
- the personnel is instructed regularly about relevant occupational safety and environmental protection aspects, and is familiar with the operating manual and in particular the safety notes contained herein
- the operation manual is in good condition and complete, and always available for reference at the location of the product
- none of the safety and warning notes attached to product are removed, and that all notes remain legible.

## 2 Product Description

### 2.1 Product Overview



A common application in machine and plant construction is the simultaneous display of a PC screen on several monitors. Up to four DVI/USB Control Panels can be connected to a PC via the CU8810-0000 DVI Splitter. Thanks to DVI/USB extension technology, the Control Panels can each be connected at distances of 50 m from the DVI Splitter. PCs with two DVI outputs, which are configured as extended desktops, generate two different screen contents. Both DVI outputs can be fed into the DVI Splitter. Using DIP switches, the four DVI outputs can each be assigned to one of the two DVI inputs, so that the Control Panels show either the left or the right half of the desktop, as selected.

Other outstanding features are:

- metal housing for DIN rail installation
- compact industrial design
- 2 DVI-D inputs, 4 DVI-D outputs
- assignment of the 4 DVI outputs to the 2 inputs freely configurable via DIP switches
- DVI inputs and outputs with full DVI data range up to 1.65 Gbit/s
- unused DVI input and outputs can be switched off to save energy
- 4-port USB hub with 4 USB Extended outputs as RJ 45 connectors
- USB transfer rate up to 12 Mbit/s for USB 1.1, downwards compatible to USB 1.0
- 24 V DC power supply.

## 2.2 Connections

### 2.2.1 Power Supply (X10)

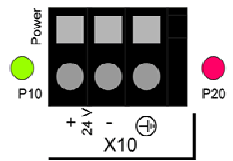

**X10**

The DVI Splitter will be powered by a 24 V<sub>DC</sub> power supply (**X10**). The pins have to be connected as shown on the front panel of the CU8810-0000 device.

One 3-pole power supply connector is provided, the pin assignment is shown at the imprint beside the connector. The low resistance protective earthing connection is established via the ground pin.



**Note**

#### Malfunction possible with missing ground connection

A proper ground connection of the device is absolutely necessary for the correct function of the touchscreen.

### 2.2.2 Data Connectors

The CU8810-0000 has three kinds of connectors: USB type B, RJ45 and DVI. The pin layouts are described below.

#### 2.2.2.1 USB Typ B Port (X20) (standard cable)

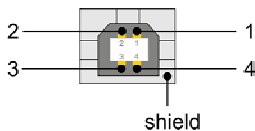

**X20**

Connector USB TYP-B LP-mount. WS

Pin	Signal	Pin	Signal
1	VCC	4	GND
2	Data -	Shield	Shield
3	Data+		

#### 2.2.2.2 RJ 45-Port (X30, X31, X32, X33) (standard CAT5 cable)



**X30, X31, X32, X33**

BA 1x8pole RJ45 Invers shield 2XLWL Lp-mount. Molex Nr: 43860-0016 Modular Jack

Pin	Signal	Assignment	Pin	Signal	Assignment
1	15 V	15 V +	5	RX	USB RX
2	GND	GND	6	TX	USB TX
3	TX	USB TX	7	15 V	15 V +
4	RX	USB RX	8	GND	GND



**2.2.2.3 DVI Input (DVI-IN X40, X41) (standard DVI cable)**

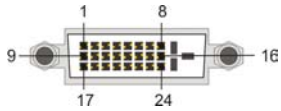

**X40, X41**

Connector DVI-D 3x8pole Digital LP-mount.

Pin	Signal	Pin	Signal
1	TMDS Data 2-	13	n.c.
2	TMDS Data 2+	14	+ 5 V Power Supply
3	TMDS Data2/4 Shield	15	GND ( +5 V, Analog H/V Sync)
4	n.c.	16	Hot Plug Detect
5	n.c.	17	TMDS Data 0 -
6	DDC Clock	18	TMDS Data 0 +
7	DDC Data	19	TMDS Data 0/5 Shield
8	Analog Vertical Sync	20	n.c.
9	TMDS Data 1 -	21	n.c.
10	TMDS Data 1 +	22	TMDS Clock Shield
11	TMDS Data1/3 Shield	23	TMDS Clock +
12	n.c.	24	TMDS Clock -

**2.2.2.4 DVI Output (DVI-OUT X50, X51, X52, X53) (standard DVI cable)**

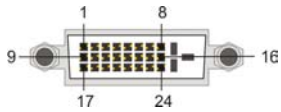

**X50, X51, X52, X53**

Connector DVI-D 3x8pole Digital LP-mount.

Pin	Signal	Pin	Signal
1	TMDS Data 2-	13	n.c.
2	TMDS Data 2+	14	+ 5 V Power Supply
3	TMDS Data2/4 Shield	15	GND ( +5 V, Analog H/V Sync)
4	n.c.	16	Hot Plug Detect
5	n.c.	17	TMDS Data 0 -
6	DDC Clock	18	TMDS Data 0 +
7	DDC Data	19	TMDS Data 0/5 Shield
8	Analog Vertical Sync	20	n.c.
9	TMDS Data 1 -	21	n.c.
10	TMDS Data 1 +	22	TMDS Clock Shield
11	TMDS Data1/3 Shield	23	TMDS Clock +
12	n.c.	24	TMDS Clock -

## 2.3 LED-Diagnostics



The following table shows the possible states for the LEDs:

LED	Assignment	Status	Meaning
P10	Power Supply	off	No power supply connected
		lights green	24 V <sub>DC</sub> connected
P20	USB/IN Port	off	USB is operational
		lights red	USB is in suspend mode/ no device connected
P30	USB/E Port-0	off	No 15 V supplied to USB/E Port
		lights green	15 V supplied to USB/E Port
P31	USB/E Port-0	off	No suspend
		lights yellow	Suspend
P32	USB/E Port-1	off	No 15 V supplied to USB/E Port
		lights green	15 V supplied to USB/E Port
P33	USB/E Port-1	off	No suspend
		lights yellow	Suspend
P34	USB/E Port-2	off	No 15 V supplied to USB/E Port
		lights green	15 V supplied to USB/E Port
P35	USB/E Port-2	off	No suspend
		lights yellow	Suspend
P36	USB/E Port-3	off	No 15 V supplied to USB/E Port
		lights green	15 V supplied to USB/E Port
P37	USB/E Port-3	off	No suspend
		lights yellow	Suspend

## 3 Installation

### 3.1 Transport and Unpacking

The specified storage conditions must be observed (see chapter [Technical Data](#)).

#### 3.1.1 Transport

Despite the robust design of the unit, the components are sensitive to strong vibrations and impacts. During transport, the unit should therefore be protected from excessive mechanical stress. Therefore, please use the original packaging.

**Attention****Danger of damage to the unit**

If the device is transported in cold weather or is exposed to extreme variations in temperature, make sure that moisture (condensation) does not form on or inside the device.

Prior to operation, the unit must be allowed to slowly adjust to room temperature. Should condensation occur, a delay time of approximately 12 hours must be allowed before the unit is switched on.

#### 3.1.2 Unpacking

Proceed as follows to unpack the unit:

1. Remove packaging
2. Do not discard the original packaging. Keep it for future relocation
3. Check the delivery for completeness by comparing it with your order
4. Please keep the associated paperwork. It contains important information for handling the unit
5. Check the contents for visible shipping damage.

If you notice any shipping damage or inconsistencies between the contents and your order, you should notify Beckhoff Service.

## 3.2 Mounting / Unmounting

The CU8810-0000 can be snapped onto a 35 mm mounting rail conforms to EN 50022.

### 3.2.1 Mounting the DVI Splitter

Just push the unit on the lower side under the rail **(1)** and snap in the upper side **(2)** as shown below:

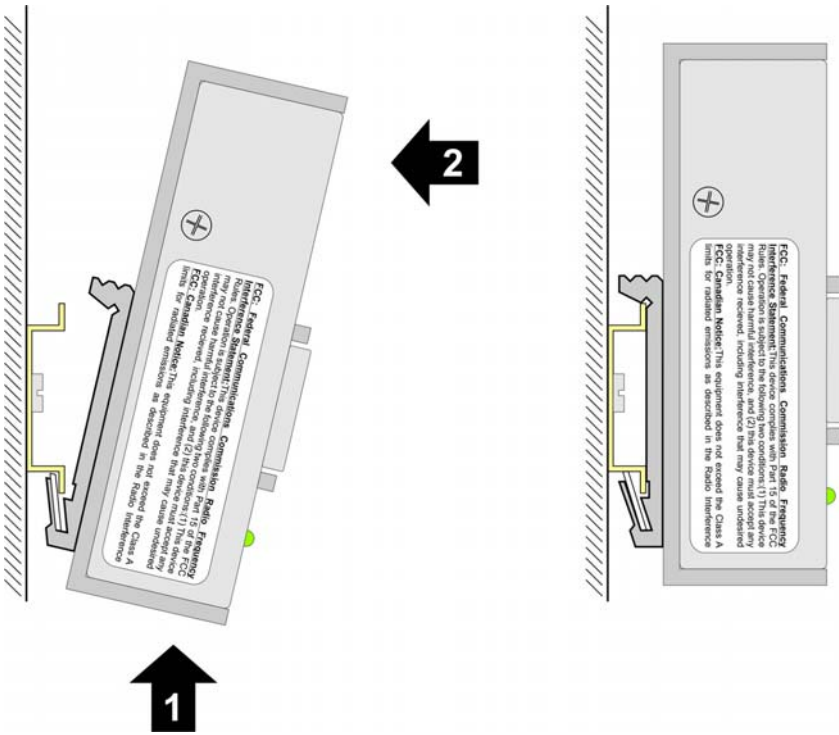

### 3.2.2 Unmounting the DVI Splitter

To release the CU8810 from the mounting rail push up the unit **(3)** and pull off the device from the rail **(4)**:

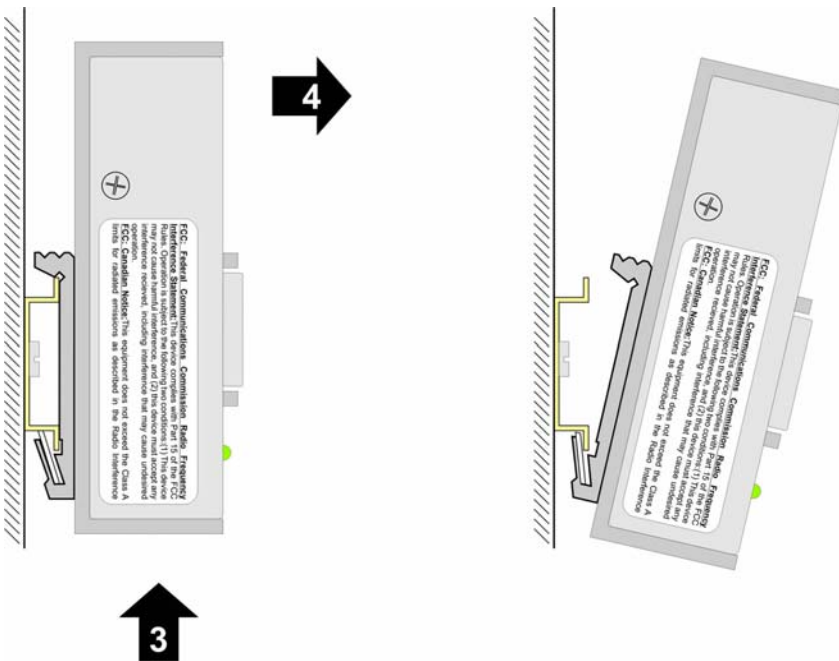

## 3.3 Connecting devices

 <p><b>Attention</b></p>	<p><b>The power supply plug must be withdrawn</b></p> <p>Please read the documentation for the external devices prior to connecting them!</p> <p>During thunderstorms, plug connector must neither be inserted nor removed!</p> <p>When disconnecting a plug connector, always handle it at the plug. Do not pull the cable!</p>
---	--

### 3.3.1 Connecting cables

The connections are documented in the section [Product Description](#).

When connecting the cables to the CU8810-0000, proceed according to the following sequence:

- Switch off all the devices that are to be connected
- Disconnect all the devices that are to be connected from the power supply
- Connect all the cables between the CU8810-0000 and the devices that are to be connected
- Reconnect all devices to the power supply.

### 3.3.2 Connecting Power Supply

1. Check that the external power supply is providing the correct voltage.
2. Connect the unit to your external 24 V<sub>DC</sub> power supply.

# 4 Operation

## 4.1 Configuration

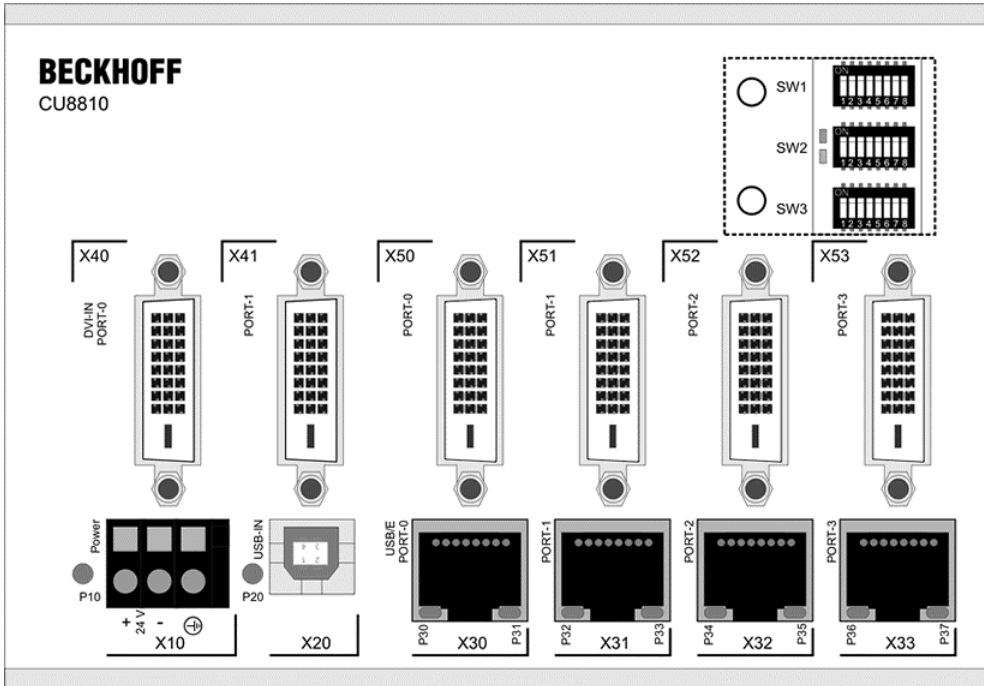

Front view of the CU8810-0000 with opened enclosure

### 4.1.1 Opening the enclosure

The device is configured by a set of three switches. The switches are covered by an enclosure on the upper right side on the front. To open the enclosure you need to remove the two screws, as shown below:



There are three DIP switches and two status LEDs covered by the plate. The detailed functions are described in the following.

### 4.1.2 DIP Switch 1 (SW1)

This DIP switch configures the DVI input sources and the DDC signals.

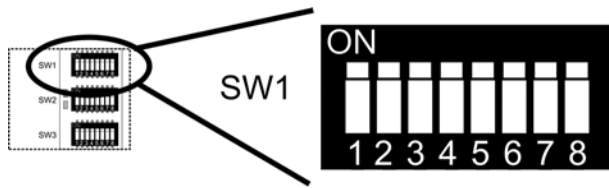

Switch	Name	Function
1	PWRDVI1	Activate DVI Input Port 0 (X40)
2	PWRDVI2	Activate DVI Input Port 1 (X41)
3	OUT-LEVEL	Set output level for DVI Output
4	N.C.	Not used
5	A0_0	Address switch A0 for DVI Input Port 0 (X40)
6	A1_0	Address switch A1 for DVI Input Port 0 (X40)
7	A0_1	Address switch A0 for DVI Input Port 1 (X41)
8	A1_1	Address switch A1 for DVI Input Port 1 (X41)

#### 4.1.2.1 PWRDVI1/ PWRDVI2

The first two switches are used to enable/ disable the two DVI Input Ports:

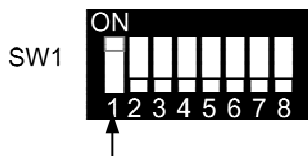

PWRDVI1	Function
on	DVI Input Port 0 is activated
off	DVI Input Port 0 is deactivated

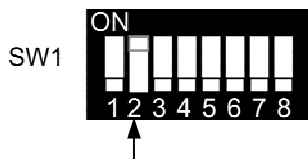

PWRDVI2	Function
on	DVI Input Port 1 is activated
off	DVI Input Port 1 is deactivated

#### 4.1.2.2 OUT-LEVEL

The next switch 3 is used to set the back termination for the output level. The use of back terminations is highly recommended for best signal integrity.

 <b>Note</b>	<b>Factory Settings</b> This switch is set to off by factory and should only be changed after consultation with the Beckhoff Support.
--	--

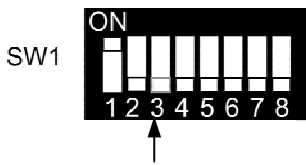

OUT-LEVEL	Function
on	No back termination is used
off	Back termination is used

**4.1.2.3 Switch 5 und 6**

Switch 5 and 6 are paired to select the source for the DDC signal for DVI Input Port 0. The DCC signal from the selected port is send to the device connected to DVI Input Port 0.

The following table shows the possible selections.

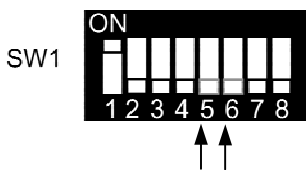

5	6	Function
off	off	The DDC-channel from DVI Input Port 0 (X40) is connected to DDC-channel to DVI Output Port 0 (X50)
on	off	The DDC-channel from DVI Input Port 0 (X40) is connected to DDC-channel to DVI Output Port 1 (X51)
off	on	The DDC-channel from DVI Input Port 0 (X40) is connected to DDC-channel to DVI Output Port 2 (X52)
on	on	The DDC-channel from DVI Input Port 0 (X40) is connected to DDC-channel to DVI Output Port 3 (X53)

**4.1.2.4 Switch 7 und 8**

Switch 7 and 8 are paired to select the source for the DDC signal for DVI Input Port 1. The DCC signal from the selected port is send to the device connected to DVI Input Port 1.

The following table shows the possible selections.

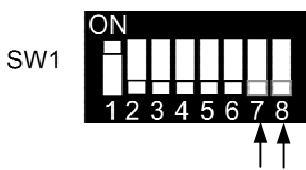

7	8	Function
off	off	The DDC-channel from DVI Input Port 1 (X41) is connected to DDC-channel to DVI Output Port 0 (X50)
on	off	The DDC-channel from DVI Input Port 1 (X41) is connected to DDC-channel to DVI Output Port 1 (X51)
off	on	The DDC-channel from DVI Input Port 1 (X41) is connected to DDC-channel to DVI Output Port 2 (X52)
on	on	The DDC-channel from DVI Input Port 1 (X41) is connected to DDC-channel to DVI Output Port 3 (X53)



 <b>Note</b>	<p><b>Danger of Collision</b></p> <p>The DDC-channel of one DVI Output Port must not be mapped to both DVI Input Ports. If there is no collision the green LED lights up. If there is a collision the red LED lights up and the user has to change the DDC-channel settings.</p>
--	--

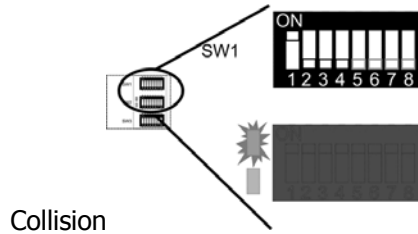
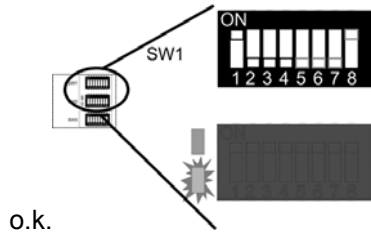

### 4.1.3 DIP Switch 2 (SW2)

This DIP switch block configures the signal parameters for DVI Output Ports.

 <b>Note</b>	<p><b>Factory Settings</b></p> <p>These switches are set as default from factory and should <b>not</b> be changed.</p>
--	--

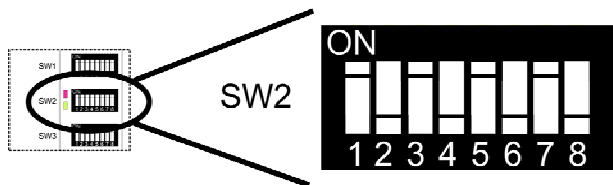

The default settings are:

Switch	Setting
1	on
2	off
3	on
4	off
5	on
6	off
7	on
8	off

### 4.1.4 DIP-Switch 3 (SW3)

This switch configures the output ports of the device. For each output port there are two switches to select an input source.

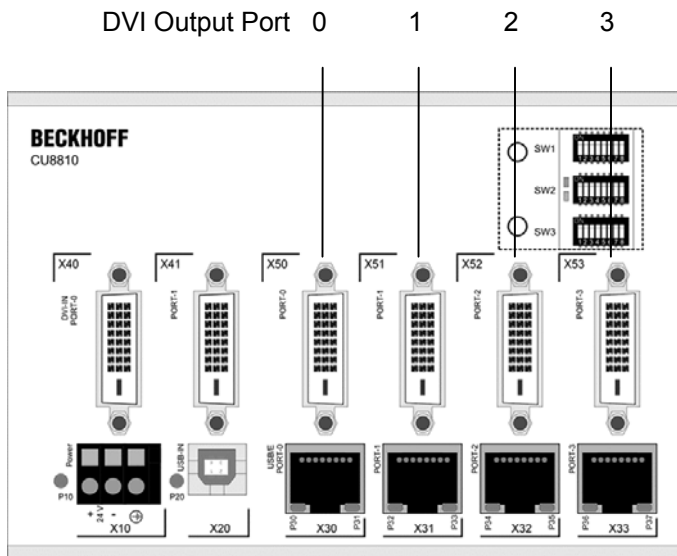
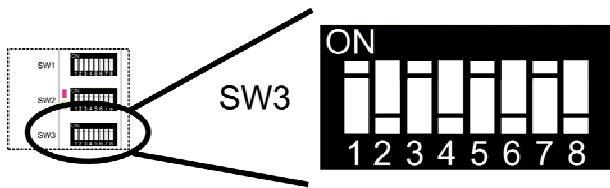

Switch	Name	Port	Function
1	IN_SEL0_high	0 (X50)	DVI Data Input Select Switch 1 for DVI Output Port 0 (X50)
2	IN_SEL0_low	0 (X50)	DVI Data Input Select Switch 2 for DVI Output Port 0 (X50)
3	IN_SEL1_high	1 (X51)	DVI Data Input Select Switch 1 for DVI Output Port 1 (X51)
4	IN_SEL1_low	1 (X51)	DVI Data Input Select Switch 2 for DVI Output Port 1 (X51)
5	IN_SEL2_high	2 (X52)	DVI Data Input Select Switch 1 for DVI Output Port 2 (X52)
6	IN_SEL2_low	2 (X52)	DVI Data Input Select Switch 2 for DVI Output Port 2 (X52)
7	IN_SEL3_high	3 (X53)	DVI Data Input Select Switch 1 for DVI Output Port 3 (X53)
8	IN_SEL3_low	3 (X53)	DVI Data Input Select Switch 2 for DVI Output Port 3 (X53)

IN_SELx_high	IN_SELx_low	Function
off	off	Disable the DVI Output Port x
off	on	Select DVI Input Port 1 (X41) for DVI Output Port x
on	off	Select DVI Input Port 0 (X40) for DVI Output Port x
on	on	Illegal

**Example**



The displayed DIP Switch settings result in the following functions:

Switch	Setting	Function
1	off	Disable DVI Output Port 0 (X50)
2	off	
3	off	Select DVI Input Port 1 (X41) for DVI Output Port 1 (X51)
4	on	
5	on	Select DVI Input Port 0 (X40) for DVI Output Port 2 (X52)
6	off	
7	on	Select DVI Input Port 0 (X40) for DVI Output Port 3 (X53)
8	off	

## 4.2 Architecture Description

### 4.2.1 Version 1

A PC with DVI output transfers an identical display image to up to four Control Panels. Command signals can be transferred to the PC via USB from each Control Panel.

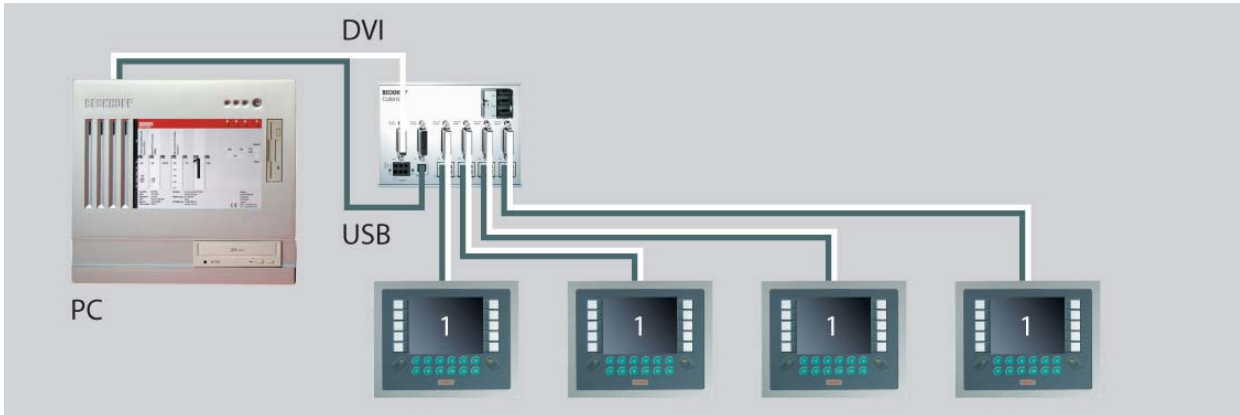

### 4.2.2 Version 2

If two PCs with one DVI output each are used, two different images can be transferred to the Control Panels. The two images may have different screen resolutions.

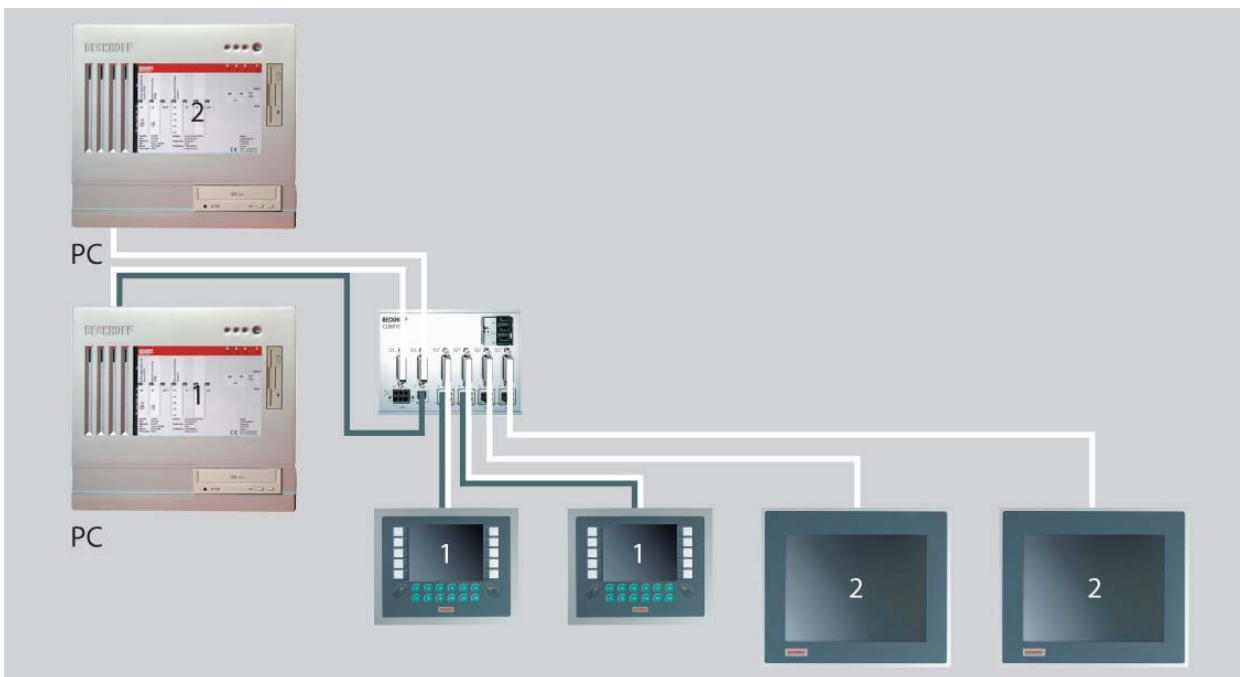

### 4.2.3 Version 3

The two-PC principle also works using a PC with Core™ Duo technology. If two DVI outputs are used, two different images can be transferred to the Control Panels. The two images may have different screen resolutions. The two-channel C9900-A185 ADD2 card offers a simple option for installing an additional DVI output. The card has two external DVI ports and enables direct connection of two DVI/USB Control Panels to C5102, C6140, C6150, C6240 or C6250 PCs. Via the CU8810, these two DVI outputs can be branched further to up to four Control Panels.

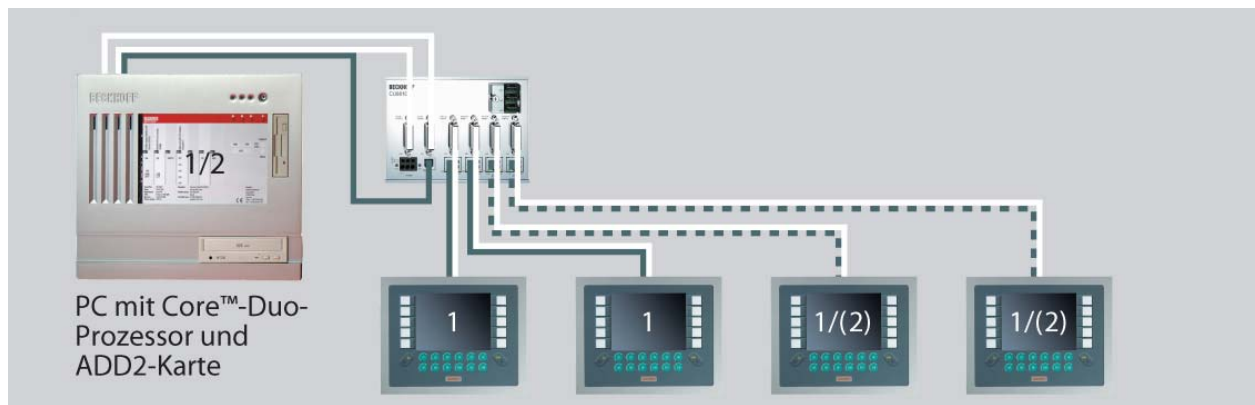

#### 4.2.4 Version 4

If a Panel PC with DVI output is used (e.g. “Economy” Panel PC CP62xx), the DVI Splitter can be used to transfer an image that differs from the main image on the Panel PC to up to four Control Panels. In this case commands can also be transferred via USB from the individual Control Panels to the Panel PC.

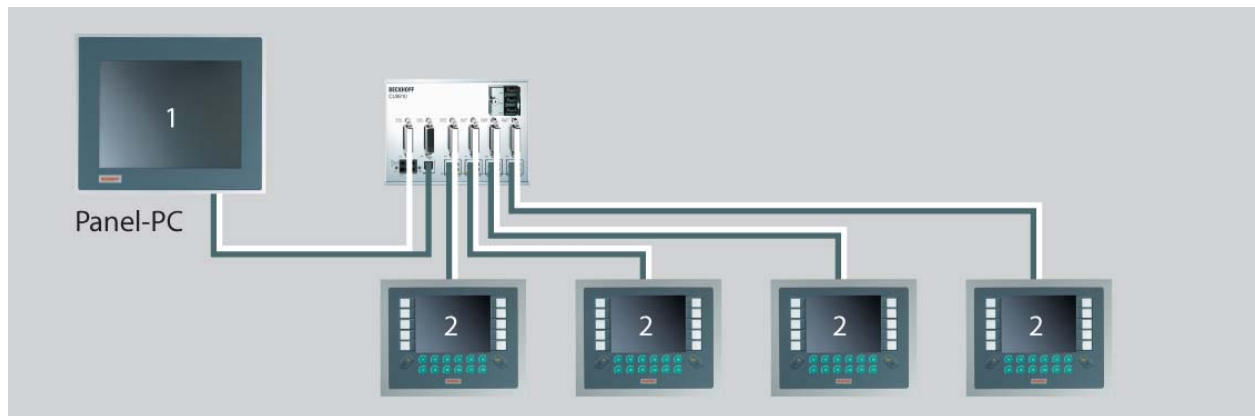

## 4.3 Maintenance

### 4.3.1 Cleaning

 <b>DANGER</b>	<b>Disconnect power supply</b> Switch off the device and all connected devices, and disconnect the device from the power supply.
--	---

The device can be cleaned with a soft, damp cloth. Do not use any aggressive cleaning materials, thinners, scouring material or hard objects that could cause scratches.

### 4.3.2 Maintenance

The DVI Splitter CU8810-0000 is maintenance-free.

## 4.4 Shutting down

### 4.4.1 Disposal

 <b>Note</b>	<b>Observe national electronics scrap regulations</b> Observe the national electronics scrap regulations when disposing of the device.
---	---

In order to dispose of the device, it must be removed and fully dismantled:

- Housing components (polycarbonate, polyamide (PA6.6)) are suitable for plastic recycling
- Metal parts can be sent for metal recycling
- Electronic parts such as disk drives and circuit boards must be disposed of in accordance with national electronics scrap regulations.

# 5 Dimensions

The product is characterized by small overall installed size. With a height of approx. 100 mm, the module dimensions exactly match those of the Beckhoff Bus Terminals. Together with the lowered connector surfaces, this means that it can be used in a standard terminal box with a height of 120 mm.

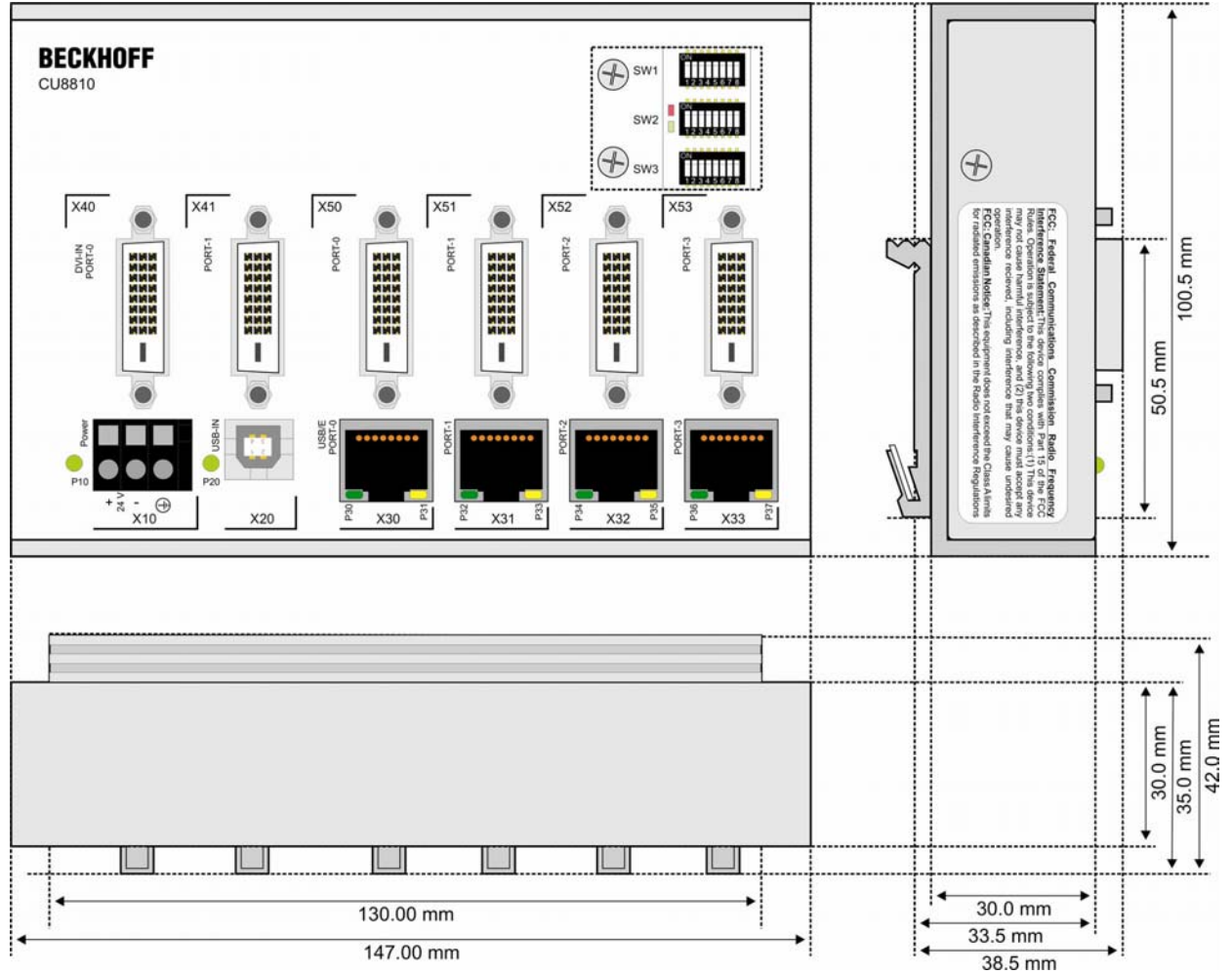

## 6 Technical Data

Product name	CU8810-0000
Number of ports	1 USB Typ B port (downstream)
	4 USB Extender Rx ports (RJ45)
	2 DVI input ports
	4 DVI output ports
Supported standard	USB 1.1
Supported baud rates	12 Mbit (Full Speed), 1.5 Mbit (Low Speed)
Status display	12 LEDs
USB extension wiring length	maximum 50 meters
USB wiring length	maximum 1 meter
Power supply	24 V <sub>DC</sub> (-15% to +20%), protected against polarity reversal. To meet the UL requirements use 4 A fuse or class 2 power supply!
Power consumption	app. 2.7 W
Max. current input from 5 V USB	maximum 0 mA at 5V <sub>DC</sub>
Current output over USB/E	maximum 500 mA at 15V <sub>DC</sub>
Dimensions (W x H x D)	app. 146 mm x 100 mm x 42 mm
Weight	app. 580 g
Permissible ambient temperature	0°C to +55°C (operation) -25°C to +70°C (transport/ storage)
Permissible relative humidity	5% to 95%, no condensation
EMC resistance burst / ESD	EN 60000-6-2 / EN 60000-6-4
Vibration / Shock resistance	EN 60068-2-6 / EN 60068-2-27
Assembly	on 35 mm mounting rail conforms to EN 50022
Installation position	any
Protection class	IP20
Approvals	CE, UL



# 7 Appendix

## 7.1 Beckhoff Support and Service

Beckhoff and their partners around the world offer comprehensive support and service, making available fast and competent assistance with all questions related to Beckhoff products and system solutions.

### 7.1.1 Beckhoff branches and partner companies

Please contact your Beckhoff branch office or partner company for [local support and service](#) on Beckhoff products!

The contact addresses for your country can be found in the list of Beckhoff branches and partner companies: [www.beckhoff.com](http://www.beckhoff.com). You will also find further [documentation](#) for Beckhoff components there.

### 7.1.2 Beckhoff company headquarters

Beckhoff Automation GmbH & Co. KG  
Huelshorstweg 20  
33415 Verl  
Germany

Phone: + 49 (0) 5246/963-0  
Fax: + 49 (0) 5246/963-198  
E-mail: [info@beckhoff.de](mailto:info@beckhoff.de)  
Web: <http://www.beckhoff.de/>

#### Beckhoff Support

Support offers you comprehensive technical assistance, helping you not only with the application of individual Beckhoff products, but also with other, wide-ranging services:

- world-wide support
- design, programming and commissioning of complex automation systems
- and extensive training program for Beckhoff system components

Hotline: + 49 (0) 5246/963-157  
Fax: + 49 (0) 5246/963-9157  
E-mail: [support@beckhoff.com](mailto:support@beckhoff.com)

#### Beckhoff Service

The Beckhoff Service Center supports you in all matters of after-sales service:

- on-site service
- repair service
- spare parts service
- hotline service

Hotline: + 49 (0) 5246/963-460  
Fax: + 49 (0) 5246/963-479  
E-mail: [service@beckhoff.com](mailto:service@beckhoff.com)

If servicing is required, please quote the **project number** of your product.

## 7.2 Approvals for USA and Canada

### 7.3 FCC Approval for USA

**FCC: Federal Communications Commission Radio Frequency Interference Statement**

This equipment has been tested and found to comply with the limits for a Class A digital device, pursuant to Part 15 of the FCC Rules. These limits are designed to provide reasonable protection against harmful interference when the equipment is operated in a commercial environment. This equipment generates, uses, and can radiate radio frequency energy and, if not installed and used in accordance with the instruction manual, may cause harmful interference to radio communications. Operation of this equipment in a residential area is likely to cause harmful interference in which case the user will be required to correct the interference at his own expense.

**Note****Technical modifications**

Technical modifications to the device may cause the loss of the FCC approval.

### 7.4 FCC Approval for Canada

**FCC: Canadian Notice**

This equipment does not exceed the Class A limits for radiated emissions as described in the Radio Interference Regulations of the Canadian Department of Communications.