

Manual | EN

# CX2500-0020

Audio Interface





# Inhaltsverzeichnis

<b>1 Foreword</b> .....	<b>5</b>
1.1 Notes on the documentation.....	5
1.2 Safety instructions .....	6
1.3 Documentation issue state .....	7
<b>2 Product overview</b> .....	<b>8</b>
2.1 Intended use.....	8
2.2 System overview .....	9
2.3 Technical data .....	9
<b>3 Mounting and wiring</b> .....	<b>10</b>
3.1 Unpacking, installation and transport .....	10
3.2 Dimensions.....	11
3.3 Attaching the system interface to the CX20x0 system .....	12
3.4 Installation on the mounting rail.....	13
3.5 Mounting the module lock.....	15
3.6 Connections.....	17
<b>4 Commissioning / Configuration</b> .....	<b>21</b>
4.1 Switching on and off .....	21
<b>5 Error handling and diagnostics</b> .....	<b>22</b>
5.1 Faults .....	22
5.2 Realtek Audio Manager faults .....	22
<b>6 Decommissioning</b> .....	<b>24</b>
6.1 Disassembly and disposal .....	24
<b>7 Appendix</b> .....	<b>26</b>
7.1 Certifications .....	26
7.2 Support and Service .....	27



# 1 Foreword

## 1.1 Notes on the documentation

This description is only intended for the use of trained specialists in control and automation engineering who are familiar with applicable national standards.

It is essential that the documentation and the following notes and explanations are followed when installing and commissioning the components.

It is the duty of the technical personnel to use the documentation published at the respective time of each installation and commissioning.

The responsible staff must ensure that the application or use of the products described satisfy all the requirements for safety, including all the relevant laws, regulations, guidelines and standards.

### Disclaimer

The documentation has been prepared with care. The products described are, however, constantly under development.

We reserve the right to revise and change the documentation at any time and without prior announcement. No claims for the modification of products that have already been supplied may be made on the basis of the data, diagrams and descriptions in this documentation.

### Trademarks

Beckhoff®, TwinCAT®, EtherCAT®, EtherCAT G®, EtherCAT G10®, EtherCAT P®, Safety over EtherCAT®, TwinSAFE®, XFC®, XTS® and XPlanar® are registered trademarks of and licensed by Beckhoff Automation GmbH.

Other designations used in this publication may be trademarks whose use by third parties for their own purposes could violate the rights of the owners.

### Patent Pending

The EtherCAT Technology is covered, including but not limited to the following patent applications and patents:

EP1590927, EP1789857, EP1456722, EP2137893, DE102015105702  
with corresponding applications or registrations in various other countries.

## EtherCAT®

EtherCAT® is a registered trademark and patented technology, licensed by Beckhoff Automation GmbH, Germany

### Copyright

© Beckhoff Automation GmbH & Co. KG, Germany.

The reproduction, distribution and utilization of this document as well as the communication of its contents to others without express authorization are prohibited.

Offenders will be held liable for the payment of damages. All rights reserved in the event of the grant of a patent, utility model or design.

## 1.2 Safety instructions

### Safety regulations

Please note the following safety instructions and explanations!  
Product-specific safety instructions can be found on following pages or in the areas mounting, wiring, commissioning etc.

### Exclusion of liability

All the components are supplied in particular hardware and software configurations appropriate for the application. Modifications to hardware or software configurations other than those described in the documentation are not permitted, and nullify the liability of Beckhoff Automation GmbH & Co. KG.

### Personnel qualification

This description is only intended for trained specialists in control, automation and drive engineering who are familiar with the applicable national standards.

### Description of symbols

In this documentation the following symbols are used with an accompanying safety instruction or note. The safety instructions must be read carefully and followed without fail!

#### **DANGER**

##### **Serious risk of injury!**

Failure to follow the safety instructions associated with this symbol directly endangers the life and health of persons.

#### **WARNING**

##### **Risk of injury!**

Failure to follow the safety instructions associated with this symbol endangers the life and health of persons.

#### **CAUTION**

##### **Personal injuries!**

Failure to follow the safety instructions associated with this symbol can lead to injuries to persons.

#### **NOTE**

##### **Damage to the environment or devices**

Failure to follow the instructions associated with this symbol can lead to damage to the environment or equipment.



##### **Tip or pointer**

This symbol indicates information that contributes to better understanding.

## 1.3 Documentation issue state

Version	Changes
1.0	Release version

## 2 Product overview

### 2.1 Intended use

The CX20x0 device series is a modular control system designed for DIN rail installation. The system is scalable, so that the required modules can be assembled and installed in the control cabinet or terminal box as required.

#### Only switch the PC off after closing the software

Before the Embedded PC is switched off, the software currently running on it should be stopped properly in order to avoid data loss on the hard disk. Please read the section on "Switching off".

Switch off all system components and uncouple the Industrial PC from the system if the PC is not used for control purposes, e.g. during a function test. To disconnect first pull the first terminal behind the power supply unit (optional), then pull the connectors of the fieldbus connections. System components that have been switched off must be secured against being switched on again.

The Embedded PC's power supply unit must be supplied with 24 V<sub>DC</sub>.

#### NOTE

##### Damage to the environment or devices

Do not exchange any parts when under power! The exchange of controller parts when live can lead to short-circuits or overvoltages. These can damage the controller itself and connected peripherals (terminals, monitors, input devices, etc.).

When components are being fitted or removed, the supply voltage must be switched off.

#### Software knowledge

#### NOTE

##### System malfunctions

Mandatory software knowledge! Every user must be familiar with any of the functions of the software installed on the PC that he can reach.



## 2.2 System overview

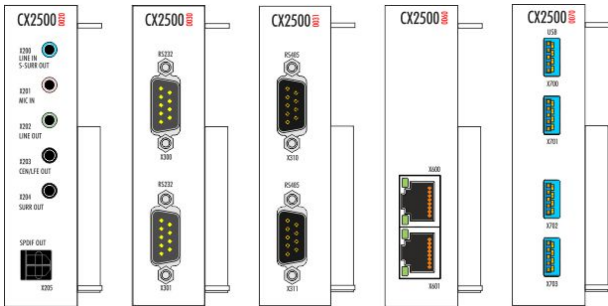

### CX2500-00xx System modules

The system modules for the CX2000 family are connected to the CPU on the left-hand side via a multi-pin connector. Internally they are connected via PCI Express. Up to four modules can be connected in any order. The CX2500-0020 audio module has jack plug (5 x 3.5 mm) and cinch plug for digital signals (SPDIF). Up to 7.1 multi-channel audio can be used. Serial interfaces can be added with the modules CX2500-0030 (RS232) and CX2500-0031 (RS422/RS485). The CX2500-0060 module provides two further independent Gbit Ethernet interfaces. The CX2500-0070 module can be used to add up to four further USB 3.0 interfaces.

The expansion modules for the CX2000 family are connected to the CPU on the right-hand side via a multi-pin connector. Up to two CX2500-0010 CFast modules can be connected, so that a total of up to three CFast slots are available.

## 2.3 Technical data

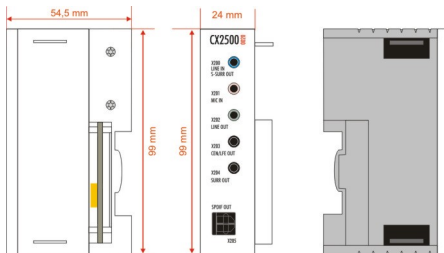

The system interface CX2500-0020 expands a CX20x0 by audio interfaces.

Technical data	CX2500-0020
Interfaces	Line IN, Line OUT, Mic IN, 7.1, SPDIF
Power supply	via system bus (through CX2100-0xxx power supply modules)
max. Power loss	0.024 W
Dielectric strength	500 V (supply / internal electronics)
Dimensions ( W x H x D)	24 mm x 99 mm x 54,5 mm
Weight	approx. 180g
Operating/storage temperature	-25° C ... +60° C / -40° C ... +85° C
Relative humidity	95% no condensation
Vibration/shock resistant	conforms to EN 60068-2-6/EN 60068-2-27
EMC immunity/emission	conforms to EN 61000-6-2/EN 61000-6-4
Protect. class	IP 20

Further information: [www.beckhoff.de/CX2000](http://www.beckhoff.de/CX2000)

## 3 Mounting and wiring

### 3.1 Unpacking, installation and transport

The specified storage conditions must be adhered to (see "Technical data").

#### Dimensions and weight of the individual modules

Dimensions (W x H x D): 24 mm x 100 mm x 55 mm

Weight: approx. 180 g (system interface)

#### Unpacking

Proceed as follows to unpack the unit:

1. Remove packaging.
2. Do not discard the original packaging. Keep it for transporting the device in the future.
3. Check the delivery for completeness by comparing it with your order.
4. Please keep the associated paperwork. It contains important information for handling the unit.
5. Check the contents for visible shipping damage.
6. If you notice any shipping damage or inconsistencies between the contents and your order, you should notify Beckhoff Service.

#### NOTE

##### **Danger of damage to the device!**

During transport in cold conditions, or if the device is subjected to extreme temperature differences, condensation on and inside the device must be avoided. Prior to operation, the device must be allowed to slowly adjust to room temperature. Should condensation occur, a delay time of approximately 12 hours must be allowed before the unit is switched on.

#### Installation

The devices are designed for installation in control cabinets.

#### Shipping and relocation

Despite the robust design of the unit, the components are sensitive to strong vibrations and impacts. During transport, your computer should therefore be protected from excessive mechanical stress. Therefore, please use the original packaging.

### 3.2 Dimensions

The following drawings show the dimensions of the CX2500-0020 interface

**Dimensions**

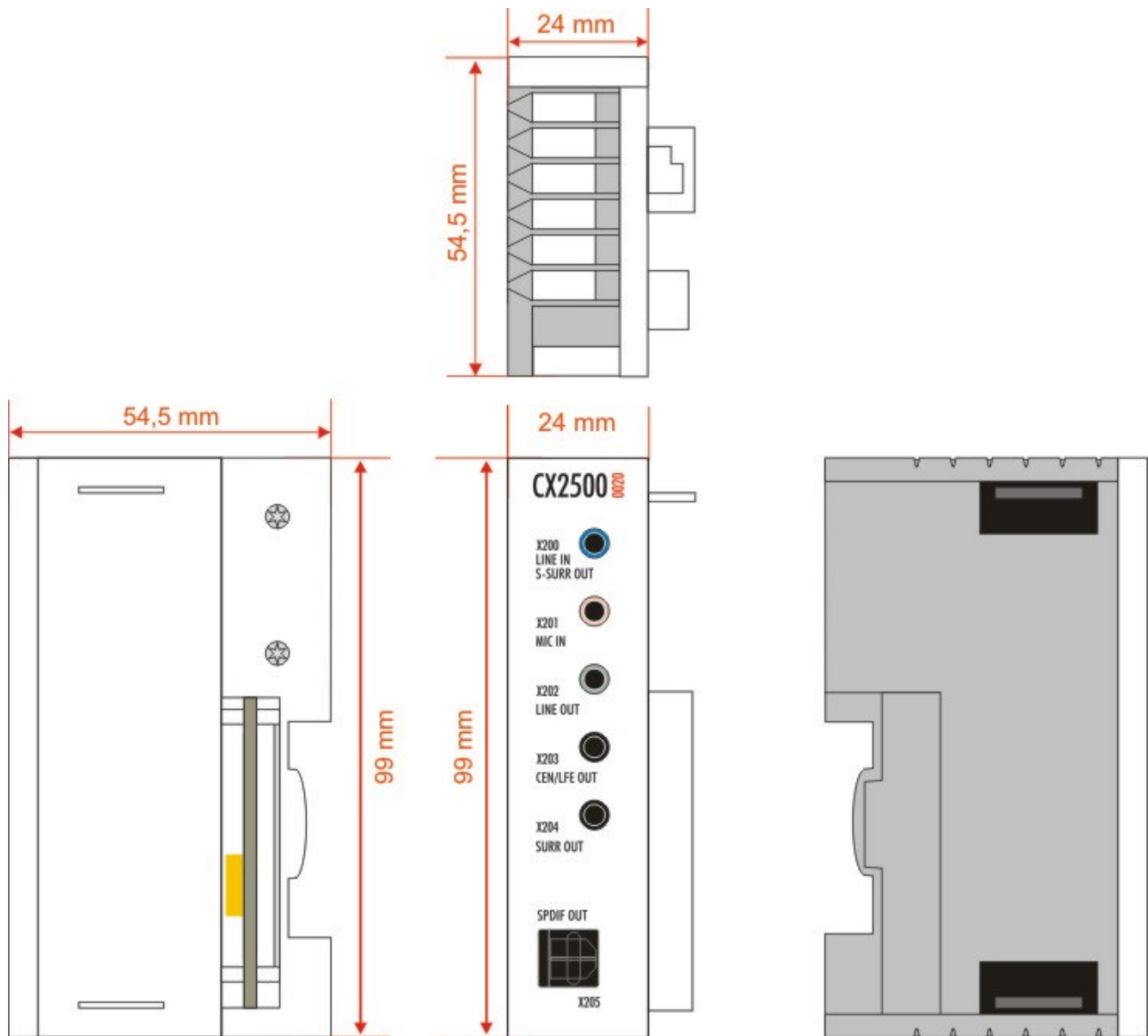

### 3.3 Attaching the system interface to the CX20x0 system

#### Opening the PCI Express bus cover

The system interfaces for the CX20x0 system are connected via the internal PCI Express bus, which has a protective cap. The cap can be removed with a screwdriver. To this end insert the screwdriver into the recess in the short side (see diagram) and lever off the cap. The bus connector is then accessible, as shown in the diagram.

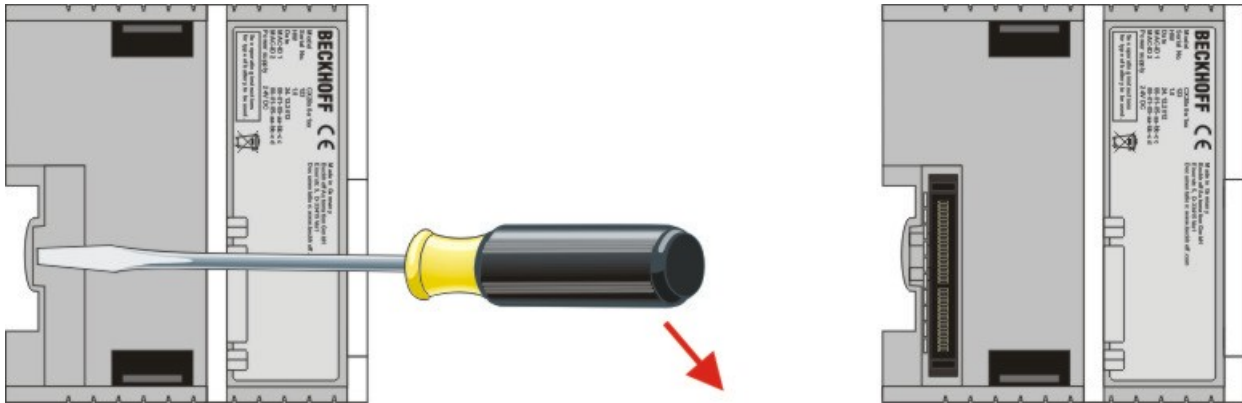

Once the bus connector is accessible, the module can be attached on the left-hand side.

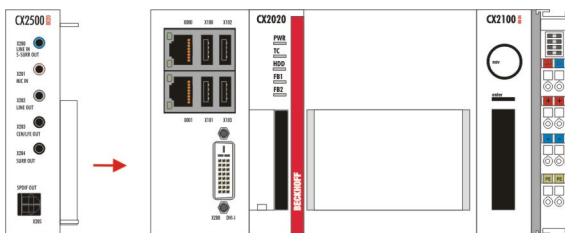

The module audibly locks into place.

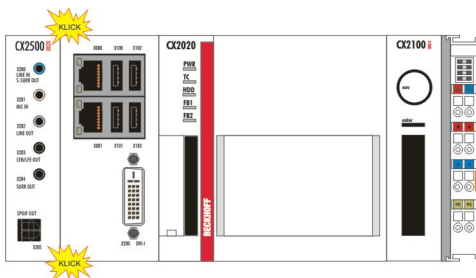

Further modules can be connected to the system in the same way. Once all modules are connected, the system is placed on the DIN rail as a block. For details please refer to the section on DIN rail mounting.

#### **i** Maximum number of system interfaces

Up to four system interfaces can be attached on the left-hand side of the system.

### 3.4 Installation on the mounting rail

#### Snapping onto the mounting rail

The CX20x0 can simply be snapped onto the mounting rail. The bar clips are inserted on the top side and underside. Then simply position the block on the mounting rail and push it slightly until it engages on the right-hand side. This is indicated by a distinct click. The bars are then engaged again. The engagement of the individual bars is indicated by a distinct click.

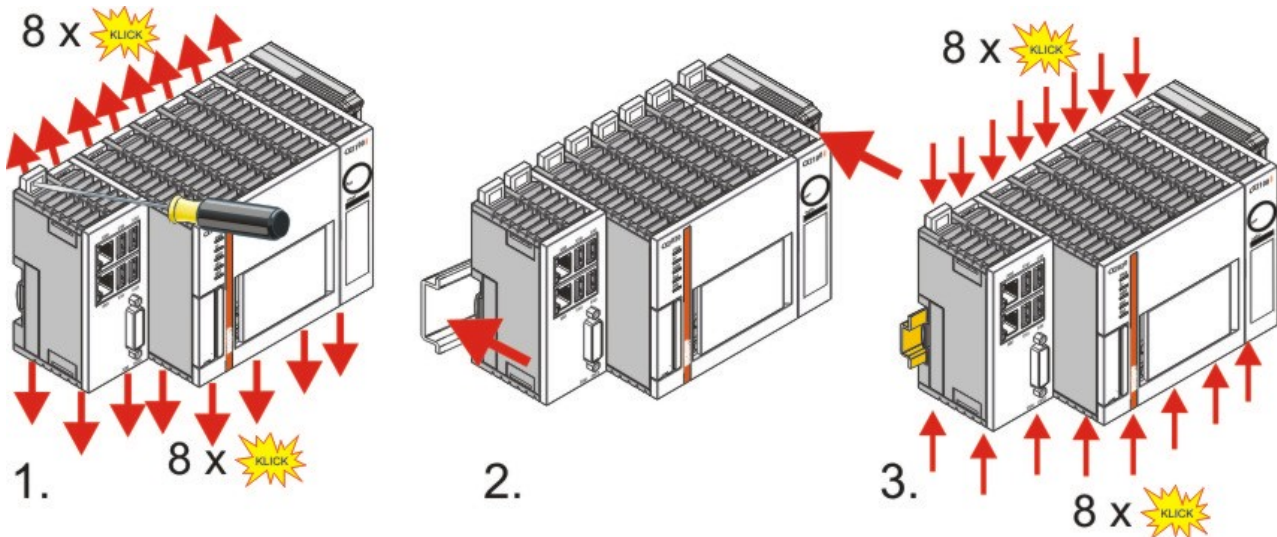

**NOTE**

**Avoid damage!**  
Do not force the module or apply excessive pressure!

#### Installation position

**NOTE**

**Comply with the permitted installation position and minimum distances!**

The maximum ambient temperature for CPU modules mounted on a DIN rail is 60°C. The orientation in which the device is fitted must be selected in such a way that cooling air can flow vertically through the ventilation holes. The images below show the permitted and two incorrect installation positions. Mounting must provide a clearance of 30 mm both above and below a CX20x0 device combination to ensure adequate ventilation of the base CPU module and the power supply unit.

#### Correct installation position

The high performance and the compact design of the CX20x0 systems may result in increased heat generation. The heat is dissipated via a passive ventilation system. This system requires the unit to be mounted correctly. Ventilation openings are located at the top and bottom of the housing. The system therefore has to be installed horizontally. This ensures optimum air flow.

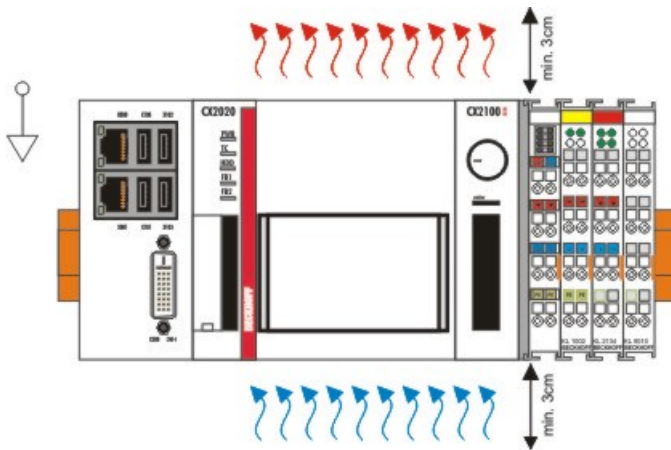

**gültige Installationslage**  
valid position

**Incorrect installation positions**

The CX20x0 system must not be operated vertically on the DIN rail. A vertical position would lead to insufficient CPU ventilation, since the ventilation openings are located on the top and bottom of the housing. Installation of the system on its side would also lead to inadequate ventilation.

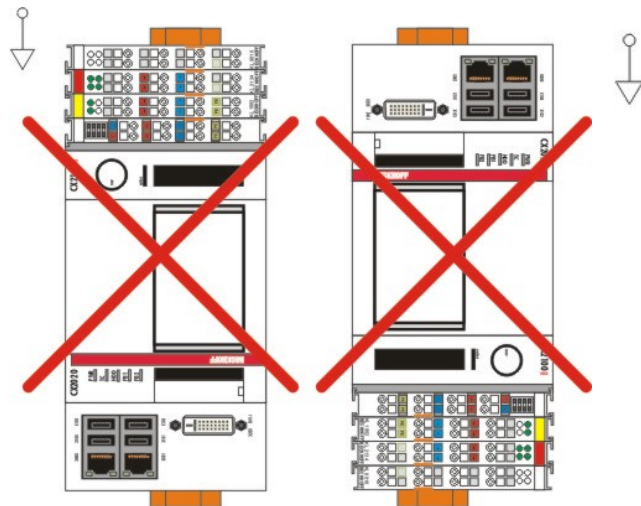

**ungültige Installationslage**  
invalid position



**ungültige Installationslage**  
invalid position

### 3.5 Mounting the module lock

#### Mounting the lock

The CX20x0 controller system is fully modular, i.e. all system interfaces of the system are field-configurable. As a rule the latching of the modules to each other is sufficiently strong. However, it is possible for the controller and its modules to be exposed to vibrations, shocks or impacts. The modules can be securely connected to one another with the aid of bar clips.

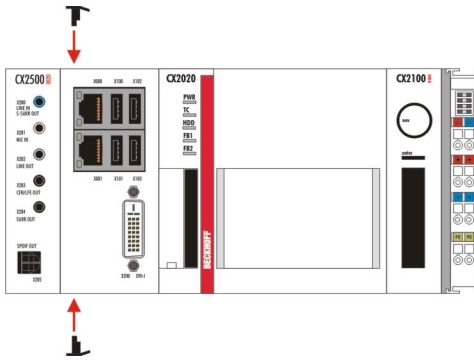

The bar clips are inserted on the top side and underside.

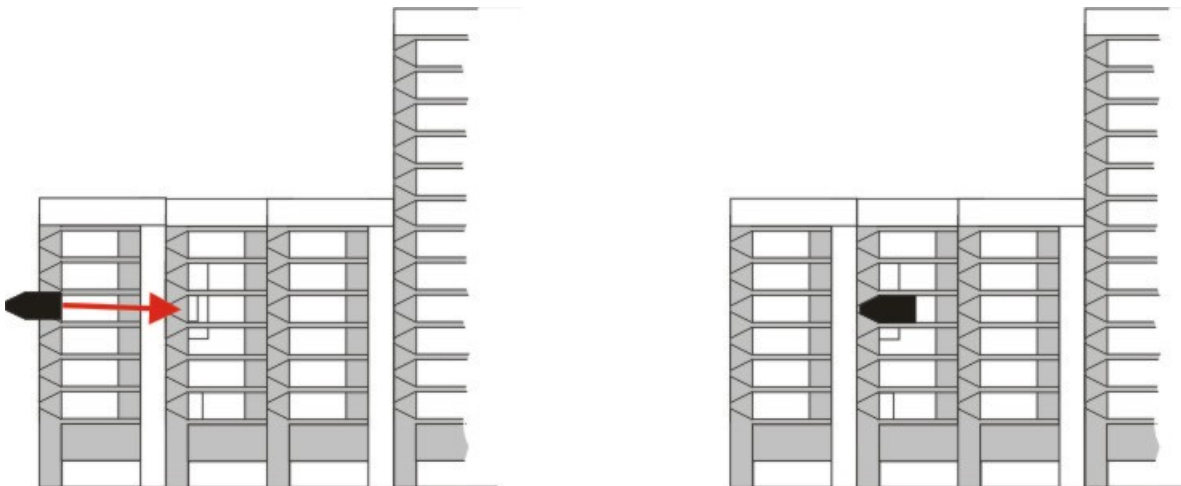

If all system interfaces are locked, then the entire assembly can be snapped onto the support rail.

#### Dismounting the lock

In order to dismantle the assembly it must first be removed from the support rail. Afterwards the bar clips can be removed with the aid of a screwdriver:

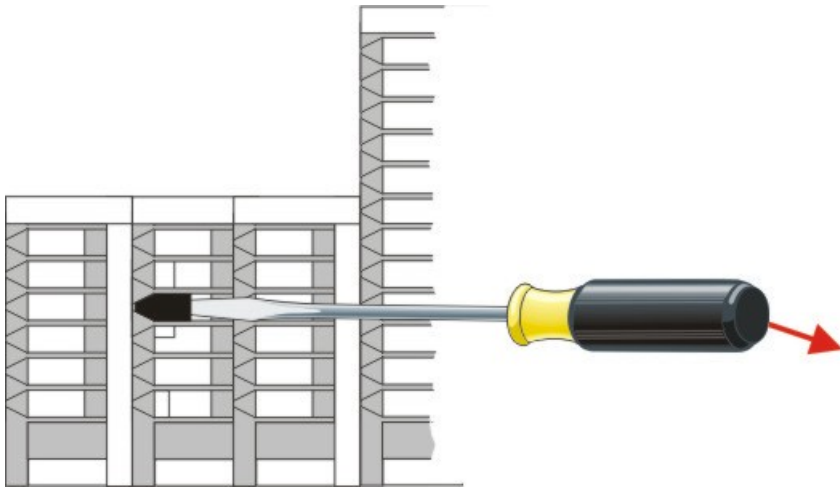

Once the bar clips have been raised they can be pulled out. Subsequently, the system interfaces can be separated again.

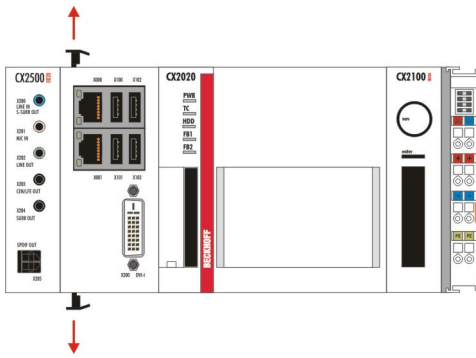



### 3.6 Connections

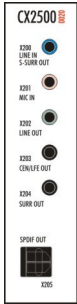

#### Adjusting the BIOS setting

**i** After connecting the hardware, change the Azalia configuration from DISABLED to ENABLED in the BIOS chipset to make sure the interface is detected. Further information can be found in the BIOS description of the CX2000 documentation.

#### Connectors for audio devices

The CX2500-0020 devices extend the CX20x0 system with audio interfaces with 5 jack plugs and a Toslink connector for digital signals (SPDIF). Up to 7.1 multi-channel audio can be used.

A "LINE IN" input and five outputs (4 x "LINE OUT" and 1 x "SPDIF OUT") are available. LINE OUT (x202) can also be used for connecting headphones with a maximum output of 200 mW. The audio interfaces are accessed via the operating system. The 3.5 mm sockets are designed for jack plugs.

#### LINE IN /LINE OUT stereo jack plug (X200/X202/X203/X204):



The audio module operates in stereo mode as standard.

Table 1: Pin assignment Line In /Line Out:

Signal	Description
L	Left channel
R	Right channel
Ground	Ground

The left channel is transferred via the tip of the jack plug, the right channel via the first ring. The remainder of the sleeve is used for earthing.

#### MIC IN mono jack plug (X201):



The only existing channel is transferred via the tip, the remainder of the sleeve is used for earthing.

Table 2: Plug colour code:

Socket		Description
LINE IN, S-SURR OUT	X200	Line level, stereo input
MIC IN	X201	Mono or stereo microphone input
LINE OUT	X202	Front speakers, headphones, stereo output
CEN/LFE out black (normally orange)	X203	Subwoofer and center, stereo output
SURR OUT black	X204	Rear speakers stereo output

**SPDIF OUT (x205):**

TOSLINK connector for digital signals.

**Configuration with the Realtek HD Audio Manager:**

Various audio settings are available for improving the sound quality. The Manager is called up via the taskbar. Right-click on the speaker symbol and open the sound manager.

The tab show all playback and recording devices connected with the CX. The orange tick defines the respective device as standard device. This can be changed under "**Set default Device**". Further applications (e.g. multi-streaming playback/record) can be found under "**Device extended settings**".

**Speakers tab**

Realtek Audio supports a wide range of speaker configurations. Speaker settings are available for 7.1 channel, 5.1 channel, 4-channel and stereo.

The following section describes the configuration for 7.1 channel:

- 1.) Plug the audio cable into the respective audio jack, according to the color code.
- 2.) Under "**Speaker Configuration**" select 7.1 Speaker:

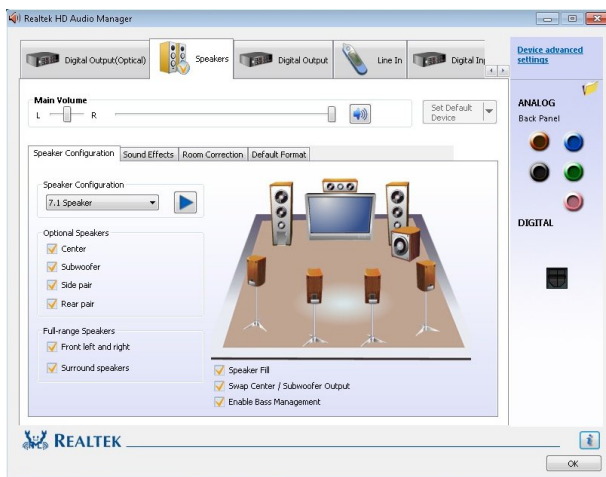

Click on the blue arrow to trigger an audio signal to verify that the sound comes from the right speaker.

Additional options:

**Speaker Fill:**

Improves the playback of surround speaker systems.

**Swap Center / Subwoofer Output:**

Swaps the centre and subwoofer outputs for playing low-frequency sound from the subwoofer.

**Enable Bass Management:**

Can be used to improve the bass signals.

**Optional speakers:**

If no subwoofer is used it should be disabled here, in order to optimize the configuration.

**Full Range Speakers**

Use this option to confirm whether a full-range speaker system is used or a small-range system.

The "**Sound Effects**" tab offers four setting options:



Environment, Equalizer, Loudness Equalization and Karaoke.

Select a filter under **"Environment"** :

- none (no filter)
- Sewer Pipe (filter)
- Bathroom (filter)
- Stone Room (filter)
- Arena (filter)
- etc.

**"Equalizer"** can be used to change the control settings for certain frequency bands. In addition there are default settings for certain types of music, e.g. Pop, Live, Club, Rock, etc. ...

**"Loudness Equalization"** can be used to compensate loudness differences perceived by the human ear. We recommend enabling Loudness Equalization for DVD playback.

The **"Karaoke"** setting filters out the voice from a song and defines the pitch of the voice.

The **"Room Correction"** tab can be used to compensate certain features of your room,

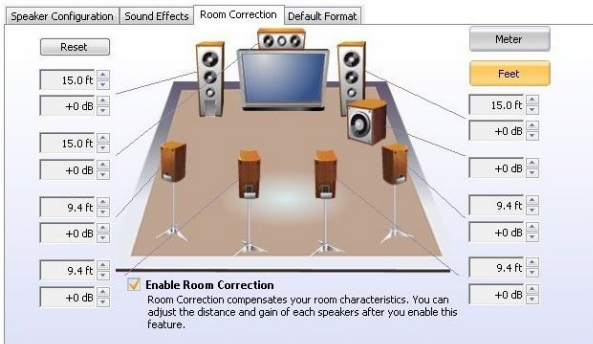

such as the distance and the amplification level of the individual speakers.

The **"Default Format"** tab adjusts the audio playback matches to the current audio type:

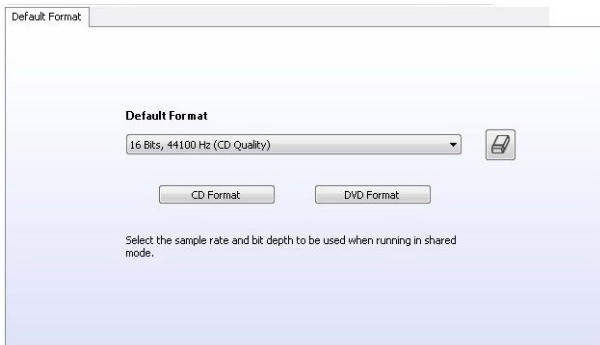

Select CD format for playback/recording a CD, select DVD for playback/recording a DVD. Other combinations of bits and sampling rate can be set manually.

### Digital Output (Optical) and Digital Output tabs

Various sound effects and the standard format settings can be set (see above).



**S/PDIF-In to S/PDIF-Out pass through mode:** Use this setting to specify real-time output of the S/PDIF-In audio signals via S/PDIF-Out.

### Microphone tab

This option can be used to enable or disable recording and playback volume, noise suppression and reverberation suppression for the microphone.

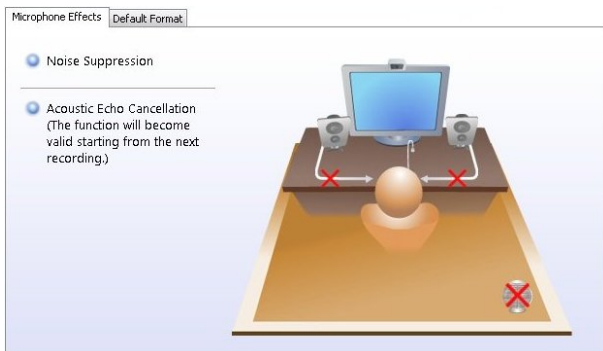

For further information please refer to the manufacturer's user manual ( Realtek HD Audio Manager).

## **4 Commissioning / Configuration**

### **4.1 Switching on and off**

#### **Switching on**

The power supply for the basic CPU module comes from the power supply unit. The basic CPU module starts automatically when the power supply unit is connected to the mains.

#### **Switching on for the first time**

When you switch on the PC for the first time, the pre-installed operating system (optional) will be started.

#### **Switching off**

The Embedded PC switches off when the power supply unit is switched off. The control software typically running on Embedded PCs should be shut down or stopped correctly. A user who may not close software may also not switch the Embedded PC off, since data can be lost from the hard disk by switching off while software is running.

Once the software has been stopped, the operating system can be shut down. Only then should the power supply be interrupted.

## 5 Error handling and diagnostics

### 5.1 Faults

Please also refer to the Safety instructions section.

#### Possible faults and their correction

Fault	Cause	Measures
no function after the Embedded PC has been switched on	no power supply for the Embedded PC other causes	1. Check the fuse 2. Measure voltage at connection, check plug wiring, call Beckhoff support
Embedded PC does not boot fully	Hard disk damaged (e.g. due to switching off while software is running), incorrect setup, other causes	Check setup Call Beckhoff Support
Computer boots, software starts, but control does not operate correctly	Cause of the fault is either in the software or in parts of the plant outside the Embedded PC	Call the manufacturer of the machine or the software.
CF card access error	Faulty CFast card, faulty CFast slot	Use a different CFast card to check the CFast slot Call Beckhoff Support
Embedded PC only works partially or temporarily	Defective components in the Embedded PC	Call Beckhoff support

Please make a note of the following information **before** contacting Beckhoff service or support:

1. Precise device ID: CXxxxx-xxxx
2. Serial number
3. Hardware version
4. Any interfaces (N030, N031, B110, ...)
5. TwinCAT version used
6. Any components / software used

The quickest response will come from support / service in your country. Therefore please contact your regional contact. For details please refer to our website at [www.beckhoff.de](http://www.beckhoff.de) or ask your distribution partner.

### 5.2 Realtek Audio Manager faults

Please also refer to the Safety instructions section.

**Possible faults and their correction**

Fault	Cause	Measures
No sound output	The device is not defined as standard device Check speaker connection	Tick to define as standard device Check speaker connection
No sound on resume from standby	If the system switches to standby, certain applications interrupt the playback function other causes	Press the Play key
Audio playback is suddenly interrupted	1.) Changing the speaker mode 2.) Changing the standard format	In music mode: Close the playback application and restart it. In DVD mode: Wait a few seconds until the playback application resumes the audio playback.

## 6 Decommissioning

### 6.1 Disassembly and disposal

The disassembly of a CX20x0 hardware configuration with system interfaces takes place in 3 steps

#### 1. Switching off and disconnecting the power supply

Before a CX20x0 system can be dismantled, the system should be switched off, and the power supply should be disconnected.

#### 2. Removing from the DIN rail

Before the individual modules are disconnected, the whole CX20x0 hardware block should be removed from the DIN rail. Proceed as follows:

##### 2.1. Release and remove the first Terminal next to the power supply unit on the DIN rail.

First remove any wiring from power supply unit *and* then from the first terminal on the DIN rail next to the power supply unit. If the wiring is to be reused for another system, it is advisable to make a note of the connections. Then pull the orange terminal release (see arrow) to release the terminal and pull it out.

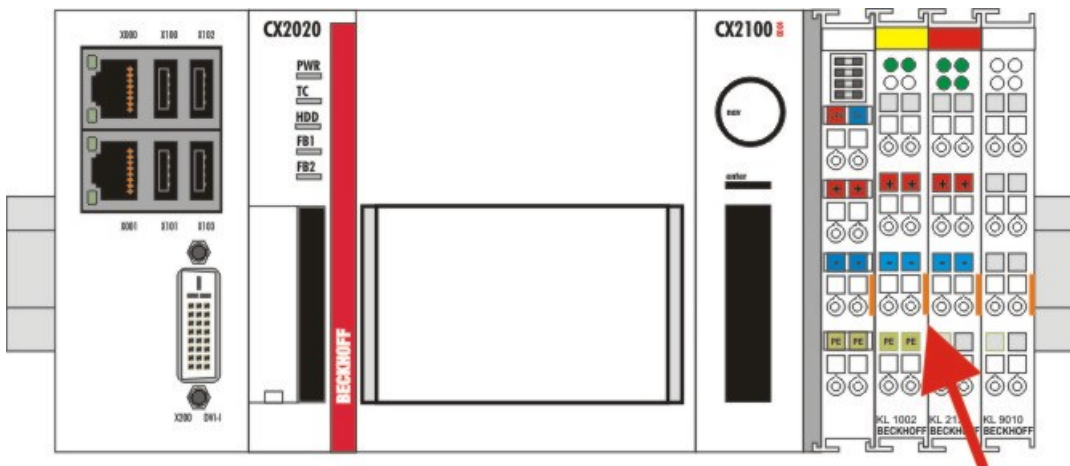

##### 2.2. Releasing the CX20x0 systems

In order to release the CX20x0 block, the DIN rail fastening above and below the device must be released. To do this, press the hooks outwards using a screwdriver. An audible click indicates that the device is released.



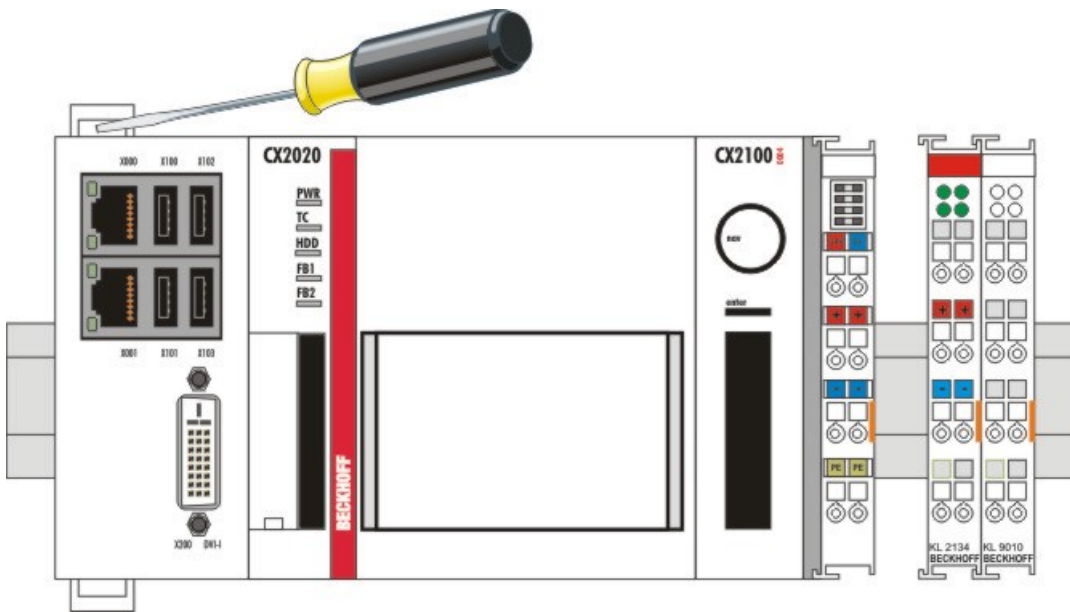

After pulling on the terminal release of the power supply unit (see arrow) the block can be **carefully** removed from the DIN rail.

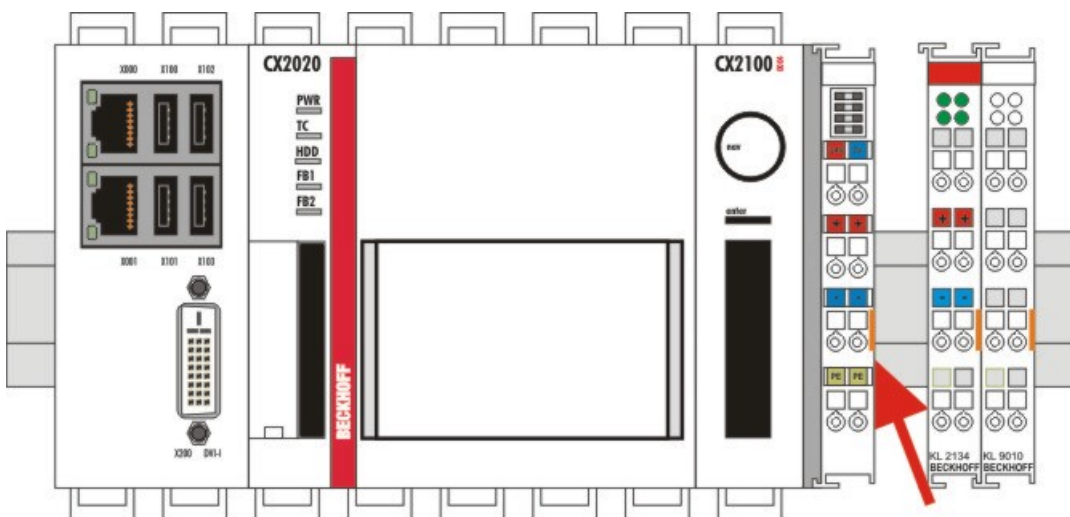

**Disposal**

The device must be fully dismantled in order to dispose of it.

Electronic parts must be disposed of in accordance with national electronics scrap regulations.

**3. Disconnecting the system interface**

Disconnecting the system modules from the basic module

If the modules are locked, i.e. attached with tie clips, the clips must be released. To this end lift the tie clips with a screwdriver and pull them out. Subsequently, the system interfaces can be separated again.

**NOTE**

**Do not use force to open the device!**

Opening the module housing by force would destroy it. The devices may only be opened by Beckhoff service personnel.

## 7 Appendix

### 7.1 Certifications

All products of the Embedded PC family are CE, UL and EAC certified. Since the product family is continuously developed further, we are unable to provide a full listing here. The current list of certified products can be found at [www.beckhoff.com](http://www.beckhoff.com).

#### **FCC Approvals for the United States of America**

##### **FCC: Federal Communications Commission Radio Frequency Interference Statement**

This equipment has been tested and found to comply with the limits for a Class A digital device, pursuant to Part 15 of the FCC Rules. These limits are designed to provide reasonable protection against harmful interference when the equipment is operated in a commercial environment. This equipment generates, uses, and can radiate radio frequency energy and, if not installed and used in accordance with the instruction manual, may cause harmful interference to radio communications. Operation of this equipment in a residential area is likely to cause harmful interference in which case the user will be required to correct the interference at his own expense.

#### **FCC Approval for Canada**

##### **FCC: Canadian Notice**

This equipment does not exceed the Class A limits for radiated emissions as described in the Radio Interference Regulations of the Canadian Department of Communications.

## 7.2 Support and Service

Beckhoff and their partners around the world offer comprehensive support and service, making available fast and competent assistance with all questions related to Beckhoff products and system solutions.

### Beckhoff's branch offices and representatives

Please contact your Beckhoff branch office or representative for local support and service on Beckhoff products!

The addresses of Beckhoff's branch offices and representatives round the world can be found on her internet pages:

<http://www.beckhoff.com>

You will also find further documentation for Beckhoff components there.

### Beckhoff Headquarters

Beckhoff Automation GmbH & Co. KG

Huelshorstweg 20  
33415 Verl  
Germany

Phone:	+49(0)5246/963-0
Fax:	+49(0)5246/963-198
e-mail:	info@beckhoff.com

### Beckhoff Support

Support offers you comprehensive technical assistance, helping you not only with the application of individual Beckhoff products, but also with other, wide-ranging services:

- support
- design, programming and commissioning of complex automation systems
- and extensive training program for Beckhoff system components

Hotline:	+49(0)5246/963-157
Fax:	+49(0)5246/963-9157
e-mail:	support@beckhoff.com

### Beckhoff Service

The Beckhoff Service Center supports you in all matters of after-sales service:

- on-site service
- repair service
- spare parts service
- hotline service

Hotline:	+49(0)5246/963-460
Fax:	+49(0)5246/963-479
e-mail:	service@beckhoff.com



More Information:  
[www.beckhoff.com/CX2500-0020](http://www.beckhoff.com/CX2500-0020)

Beckhoff Automation GmbH & Co. KG  
Hülshorstweg 20  
33415 Verl  
Germany  
Phone: +49 5246 9630  
[info@beckhoff.com](mailto:info@beckhoff.com)  
[www.beckhoff.com](http://www.beckhoff.com)

