



Doc. ID: PU-200.015.31-xxA (2020-06-03-MR1)

Product Description

The ZS5301-0006 is a mechanical accessory to mount the device sideways with or without utilizing a DIN-rail to save installation depth.

The two aluminum brackets and the black plastic slider of the unit have to be detached, so that the ZS5301-0006 steel bracket can be mounted.

For sideways DIN-rail mounting, the removed aluminum brackets and the black plastic slider need to be mounted on the ZS5301-0006 steel bracket.

The order number ZS5301-0006 contains one bracket and four screws, which are needed for sideways DIN-rail mounting.

Intended Use

This mechanical accessory is designed for DIN-rail devices. Check the product datasheet of the DIN-rail device to confirm that it is suitable for the desired device.

Technical Data

Size (width x height x depth) 65x145x63mm
Weight 180g / 0.4lb

Mechanical Dimensions

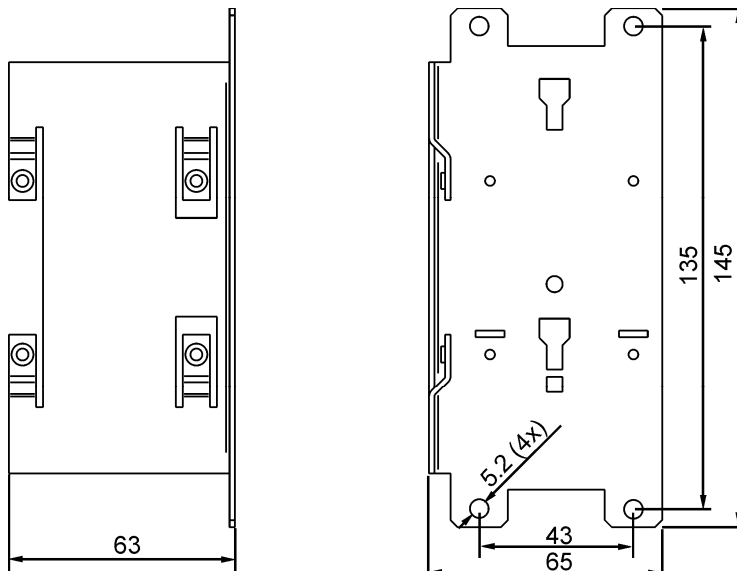

All dimensions in mm

Mounting Example – Wall Mounting

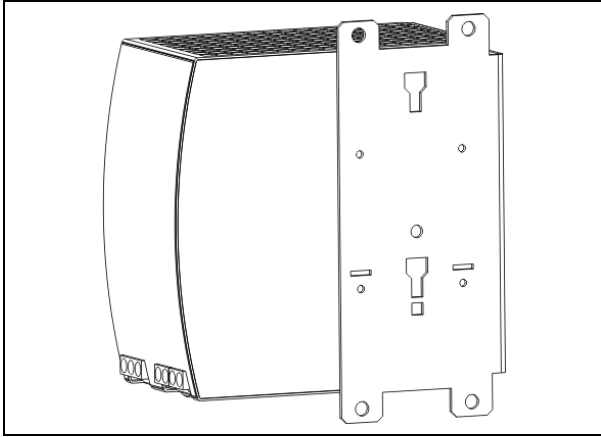

Mounting Example – DIN-Rail Mounting

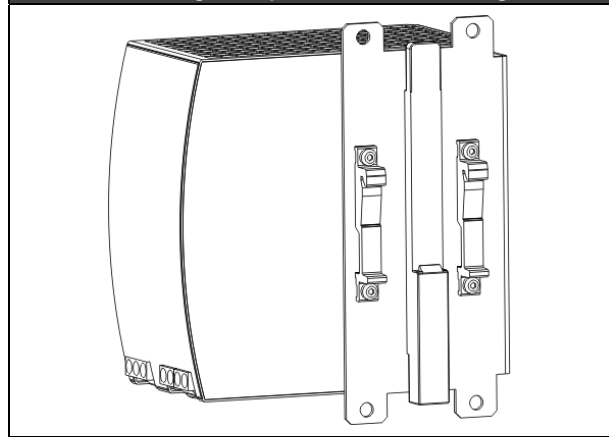

Installation Instructions

- 1) Detach the two aluminium brackets by removing the four screws with a Torx screwdriver (Torx 10). Save the screws for step 3.
- 2) Remove the plastic lock mechanism by using a flat-blade screwdriver to move the lock downwards while at the same time push the plastic slide upwards. Detach the plastic slide.
- 3) Mount the steel brackets with the same screws from the DIN-Rail brackets using caution not to over-tighten the screws! Recommended tightening torque is 0.6Nm. (5.3lb.in).

Preparation for DIN-Rail mounting

Install the two aluminium brackets and the plastic slide (detached from the unit before) onto the side mounting plant with the additional screws provided.

Installation Instructions

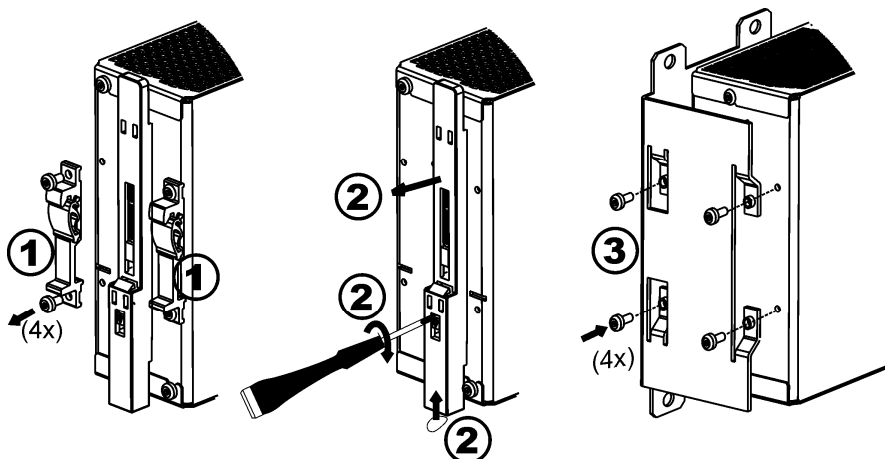

Drawing shows a similar unit