

Documentation | EN

# EP5xxx

EtherCAT Box modules for Angle and Position Measurement





# Table of contents

<b>1</b>	<b>Foreword</b> .....	<b>7</b>
1.1	Notes on the documentation .....	7
1.2	Safety instructions .....	8
1.3	Documentation issue status .....	9
<b>2</b>	<b>EtherCAT Box - Introduction</b> .....	<b>11</b>
<b>3</b>	<b>Product overview</b> .....	<b>13</b>
3.1	Module overview .....	13
3.2	EP5001-0002 .....	14
3.2.1	EP5001-0002 - Introduction .....	14
3.2.2	EP5001-0002 - Technical data.....	15
3.2.3	EP5001-0002 - Scope of supply .....	16
3.2.4	EP5001-0002 - Process image .....	17
3.3	EP5101-x002 .....	18
3.3.1	EP5101-x002 - Introduction .....	18
3.3.2	EP5101-x002 - Technical data.....	19
3.3.3	EP5101-x002 - Scope of supply.....	20
3.3.4	EP5101-x002 - Process image .....	21
3.4	EP5101-x011 .....	22
3.4.1	EP5101-x011 - Introduction .....	22
3.4.2	EP5101-x011 - Technical data.....	23
3.4.3	EP5101-x011 - Scope of supply.....	24
3.4.4	EP5101-0011 - Process image .....	25
3.4.5	EP5101-2011 - Process image .....	26
3.5	EP5151-0002 .....	27
3.5.1	EP5151-0002 – Introduction .....	27
3.5.2	EP5151-0002 - Technical data.....	28
3.5.3	EP5151-0002 - Scope of supply .....	29
3.5.4	EP5151-0002 - Process image .....	30
<b>4</b>	<b>Mounting and connection</b> .....	<b>31</b>
4.1	Mounting .....	31
4.1.1	Dimensions .....	31
4.1.2	Fixing.....	32
4.1.3	Tightening torques for plug connectors.....	32
4.2	EtherCAT .....	33
4.2.1	Connectors.....	33
4.2.2	Status LEDs .....	34
4.2.3	Cables .....	34
4.3	Supply voltages .....	35
4.3.1	Connectors.....	36
4.3.2	Status LEDs .....	36
4.3.3	Conductor losses .....	37
4.4	Signal connection and meaning of the LEDs .....	38
4.4.1	Shielding .....	38

4.4.2	EP5001-0002 - Signal connection.....	38
4.4.3	EP5101-x002 - Signal connection.....	39
4.4.4	EP5101-x011 - Signal connection.....	40
4.4.5	EP5151-0002 - Signal connection.....	41
4.5	UL Requirements .....	42
4.6	ATEX notes .....	43
4.6.1	ATEX - Special conditions.....	43
4.6.2	BG2000 - EtherCAT Box protection enclosures.....	44
4.6.3	ATEX Documentation.....	45
4.7	Disposal .....	46
<b>5</b>	<b>Commissioning/Configuration.....</b>	<b>47</b>
5.1	Integrating into a TwinCAT project.....	47
5.2	EP5001-0002 - Parameters and modes.....	48
5.2.1	Basic principles of SSI communication .....	48
5.2.2	Process data .....	49
5.2.3	DC (Distributed Clocks).....	51
5.2.4	Features CoE .....	52
5.3	EP51x1-x0xx - Parameters and modes .....	54
5.3.1	Basic function principles.....	54
5.3.2	Process data .....	55
5.3.3	DC (Distributed Clocks).....	66
5.3.4	Features CoE .....	67
5.4	EP5001 - Interface signal level .....	72
5.5	EP5101 - Interface signal level .....	73
5.6	EP5151 - Interface signal level .....	74
5.7	Restore the delivery state .....	75
5.8	Decommissioning.....	76
<b>6</b>	<b>CoE parameters.....</b>	<b>77</b>
6.1	EP5001-0002 .....	77
6.2	EP5101-x002 .....	83
6.2.1	Restore object.....	83
6.2.2	Configuration data.....	84
6.2.3	Input data .....	85
6.2.4	Output data .....	86
6.2.5	Information / diagnostic data (channel specific).....	86
6.2.6	Standard objects .....	86
6.3	EP5101-0011 .....	97
6.3.1	Restore object.....	97
6.3.2	Configuration data.....	98
6.3.3	Input data .....	100
6.3.4	Output data .....	101
6.3.5	Information / diagnostic data (channel specific).....	101
6.3.6	Standard objects .....	101
6.4	EP5151-0002 .....	110
6.4.1	Restore object.....	110

6.4.2	Configuration data .....	111
6.4.3	Input data .....	113
6.4.4	Output data .....	114
6.4.5	Standard objects .....	114
<b>7</b>	<b>Appendix .....</b>	<b>123</b>
7.1	General operating conditions .....	123
7.2	Accessories .....	124
7.3	Version identification of EtherCAT devices .....	125
7.3.1	General notes on marking .....	125
7.3.2	Version identification of IP67 modules .....	126
7.3.3	Beckhoff Identification Code (BIC) .....	127
7.3.4	Electronic access to the BIC (eBIC) .....	129
7.4	Support and Service .....	131



# 1 Foreword

## 1.1 Notes on the documentation

### Intended audience

This description is only intended for the use of trained specialists in control and automation engineering who are familiar with the applicable national standards.

It is essential that the documentation and the following notes and explanations are followed when installing and commissioning these components.

The qualified personnel is obliged to always use the currently valid documentation.

The responsible staff must ensure that the application or use of the products described satisfy all the requirements for safety, including all the relevant laws, regulations, guidelines and standards.

### Disclaimer

The documentation has been prepared with care. The products described are, however, constantly under development.

We reserve the right to revise and change the documentation at any time and without prior announcement.

No claims for the modification of products that have already been supplied may be made on the basis of the data, diagrams and descriptions in this documentation.

### Trademarks

Beckhoff®, TwinCAT®, TwinCAT/BSD®, TC/BSD®, EtherCAT®, EtherCAT G®, EtherCAT G10®, EtherCAT P®, Safety over EtherCAT®, TwinSAFE®, XFC®, XTS® and XPlanar® are registered trademarks of and licensed by Beckhoff Automation GmbH. Other designations used in this publication may be trademarks whose use by third parties for their own purposes could violate the rights of the owners.

### Patent Pending

The EtherCAT Technology is covered, including but not limited to the following patent applications and patents: EP1590927, EP1789857, EP1456722, EP2137893, DE102015105702 with corresponding applications or registrations in various other countries.



EtherCAT® is registered trademark and patented technology, licensed by Beckhoff Automation GmbH, Germany.

### Copyright

© Beckhoff Automation GmbH & Co. KG, Germany.

The reproduction, distribution and utilization of this document as well as the communication of its contents to others without express authorization are prohibited.

Offenders will be held liable for the payment of damages. All rights reserved in the event of the grant of a patent, utility model or design.

## 1.2 Safety instructions

### Safety regulations

Please note the following safety instructions and explanations!  
Product-specific safety instructions can be found on following pages or in the areas mounting, wiring, commissioning etc.

### Exclusion of liability

All the components are supplied in particular hardware and software configurations appropriate for the application. Modifications to hardware or software configurations other than those described in the documentation are not permitted, and nullify the liability of Beckhoff Automation GmbH & Co. KG.

### Personnel qualification

This description is only intended for trained specialists in control, automation and drive engineering who are familiar with the applicable national standards.

### Signal words

The signal words used in the documentation are classified below. In order to prevent injury and damage to persons and property, read and follow the safety and warning notices.

### Personal injury warnings

**⚠ DANGER**

Hazard with high risk of death or serious injury.

**⚠ WARNING**

Hazard with medium risk of death or serious injury.

**⚠ CAUTION**

There is a low-risk hazard that could result in medium or minor injury.

### Warning of damage to property or environment

**NOTICE**

The environment, equipment, or data may be damaged.

### Information on handling the product



This information includes, for example:  
recommendations for action, assistance or further information on the product.



### 1.3 Documentation issue status

Version	Comment
2.10	<ul style="list-style-type: none"> <li>• Technical data of EP5151-0002 updated</li> </ul>
2.9	<ul style="list-style-type: none"> <li>• Interface signal levels updated</li> </ul>
2.8	<ul style="list-style-type: none"> <li>• Chapter "Supply voltages" updated</li> </ul>
2.7	<ul style="list-style-type: none"> <li>• Introduction updated</li> <li>• Technical data updated</li> <li>• Signal connection updated</li> </ul>
2.6	<ul style="list-style-type: none"> <li>• Dimensions updated</li> <li>• UL requirements updated</li> </ul>
2.5	<ul style="list-style-type: none"> <li>• Front page updated</li> <li>• Scope of delivery added</li> <li>• Structure update</li> </ul>
2.4	<ul style="list-style-type: none"> <li>• EP5101-0011: Color of the Error LED corrected</li> <li>• EP5151-0002: Color of the Error LED corrected</li> </ul>
2.3.0	<ul style="list-style-type: none"> <li>• Note on <i>shielding</i> added</li> </ul>
2.2.0	<ul style="list-style-type: none"> <li>• Update chapter EP5001-0002 – <i>Signal connection</i></li> </ul>
2.1.0	<ul style="list-style-type: none"> <li>• EP5101-2011 added</li> <li>• Chapter <i>Mounting</i> updated</li> <li>• Update chapter <i>Commissioning</i></li> <li>• Structural update</li> </ul>
2.0.0	<ul style="list-style-type: none"> <li>• Migration</li> <li>• EP5001-0002 added</li> <li>• Renamed to EP5xxx</li> <li>• Several chapters updated</li> </ul>
1.6.0	<ul style="list-style-type: none"> <li>• Pin assignment updated</li> <li>• Status LEDs updated</li> <li>• Chapter on Tightening torque for connectors updated</li> <li>• Accessories updated</li> </ul>
1.5.0	<ul style="list-style-type: none"> <li>• Power Connection updated</li> </ul>
1.4.0	<ul style="list-style-type: none"> <li>• Introduction expanded</li> </ul>

Version	Modifications
1.3.0	<ul style="list-style-type: none"> <li>• EP5101-1002 and EP5151-0002 added to title page</li> <li>• EP51x1 - EP5101-1002 and EP5151-0002 added to Introduction</li> <li>• EP5151 signal level (interface signal level) added</li> <li>• Status LEDs extended with EP5101-1002 and EP5151-0002</li> <li>• Technical data extended with EP5101-1002 and EP5151-0002</li> <li>• Encoder connection, M12, 8-pin extended with EP5151</li> <li>• Information on basic function principles amended</li> <li>• Parameters and modes amended</li> <li>• EP5151-0002 process image added</li> <li>• EP5101-0002 process image amended</li> <li>• Notes on the documentation updated</li> <li>• Support &amp; service updated</li> <li>• Safety instructions updated</li> <li>• EtherCAT cables updated</li> <li>• EtherCAT Box accessories updated</li> <li>• Nut torques for connectors updated</li> <li>• EtherCAT connection updated</li> <li>• Mounting instructions updated</li> </ul>
1.2.0	<ul style="list-style-type: none"> <li>• Interface signal level amended (single-ended and differential signals)</li> </ul>
1.1.0	<ul style="list-style-type: none"> <li>• Description of the power connection updated</li> <li>• Notes on using EtherCAT Box modules (EPxxxx-xxxx) in potentially explosive atmospheres (ATEX) added to documentation.</li> </ul>
1.0.0	<ul style="list-style-type: none"> <li>• First release</li> </ul>

### Firmware and hardware versions

This documentation refers to the firmware and hardware version that was applicable at the time the documentation was written.

The module features are continuously improved and developed further. Modules having earlier production statuses cannot have the same properties as modules with the latest status. However, existing properties are retained and are not changed, so that older modules can always be replaced with new ones.

The firmware and hardware version (delivery state) can be found in the batch number (D-number) printed on the side of the EtherCAT Box.

### Syntax of the batch number (D-number)

D: WW YY FF HH

WW - week of production (calendar week)

YY - year of production

FF - firmware version

HH - hardware version

Example with D no. 29 10 02 01:

29 - week of production 29

10 - year of production 2010

02 - firmware version 02

01 - hardware version 01

Further information on this topic: [Version identification of EtherCAT devices \[► 125\]](#).

## 2 EtherCAT Box - Introduction

The EtherCAT system has been extended with EtherCAT Box modules with protection class IP67. Through the integrated EtherCAT interface the modules can be connected directly to an EtherCAT network without an additional Coupler Box. The high-performance of EtherCAT is thus maintained into each module.

The extremely low dimensions of only 126 x 30 x 26.5 mm (h x w x d) are identical to those of the Fieldbus Box extension modules. They are thus particularly suitable for use where space is at a premium. The small mass of the EtherCAT modules facilitates applications with mobile I/O interface (e.g. on a robot arm). The EtherCAT connection is established via screened M8 connectors.

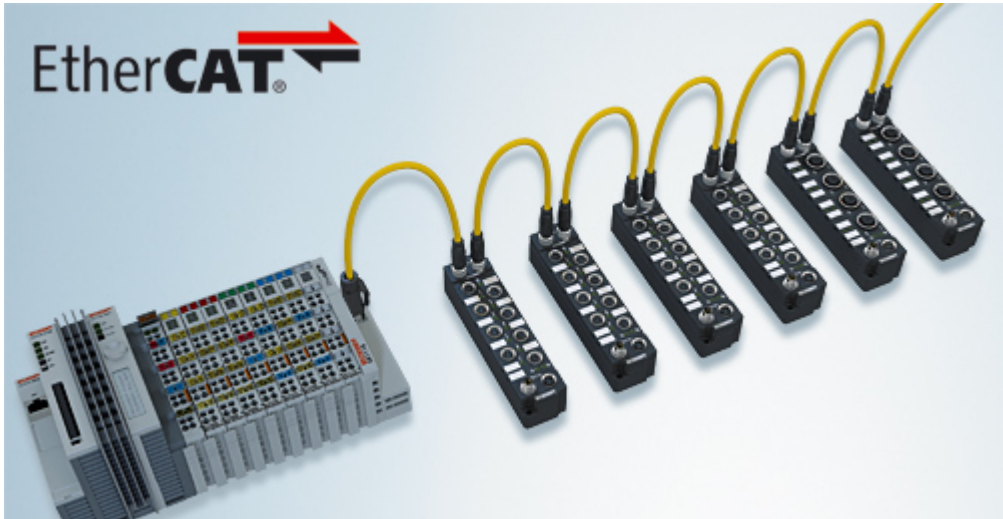

Fig. 1: EtherCAT Box Modules within an EtherCAT network

The robust design of the EtherCAT Box modules enables them to be used directly at the machine. Control cabinets and terminal boxes are now no longer required. The modules are fully sealed and therefore ideally prepared for wet, dirty or dusty conditions.

Pre-assembled cables significantly simplify EtherCAT and signal wiring. Very few wiring errors are made, so that commissioning is optimized. In addition to pre-assembled EtherCAT, power and sensor cables, field-configurable connectors and cables are available for maximum flexibility. Depending on the application, the sensors and actuators are connected through M8 or M12 connectors.

The EtherCAT modules cover the typical range of requirements for I/O signals with protection class IP67:

- digital inputs with different filters (3.0 ms or 10  $\mu$ s)
- digital outputs with 0.5 or 2 A output current
- analog inputs and outputs with 16 bit resolution
- Thermocouple and RTD inputs
- Stepper motor modules

XFC (eXtreme Fast Control Technology) modules, including inputs with time stamp, are also available.



Fig. 2: EtherCAT Box with M8 connections for sensors/actuators



Fig. 3: EtherCAT Box with M12 connections for sensors/actuators

---

● **Basic EtherCAT documentation**

**i** You will find a detailed description of the EtherCAT system in the Basic System Documentation for EtherCAT, which is available for download from our website ([www.beckhoff.com](http://www.beckhoff.com)) under Downloads.

---

## 3 Product overview

### 3.1 Module overview

#### SSI encoder interface

Module	Connection encoder/sensor	Number of channels	Sensor supply	Comment
<a href="#">EP5001-0002 [▶_14]</a>	M12 socket, 8-pin	1	24 V <sub>DC</sub>	Distributed Clocks

#### Incremental encoder interface with differential inputs

Module	Connection encoder/sensor	Number of channels	Sensor supply	Comment
<a href="#">EP5101-0002 [▶_18]</a>	M12 socket, 8-pin	1	5 V <sub>DC</sub> , 150 mA	<ul style="list-style-type: none"> <li>• Distributed Clocks</li> <li>• 4 million increments/s</li> </ul>
<a href="#">EP5101-0011 [▶_22]</a>	D-sub socket, 15-pin	1	5 V <sub>DC</sub> , 150 mA	<ul style="list-style-type: none"> <li>• Distributed Clocks</li> <li>• 4 million increments/s</li> <li>• Latch, Gate</li> </ul>
<a href="#">EP5101-1002 [▶_18]</a>	M12 socket, 8-pin	1	24 V <sub>DC</sub> , 500 mA	<ul style="list-style-type: none"> <li>• Distributed Clocks</li> <li>• 4 million increments/s</li> </ul>
<a href="#">EP5101-2011 [▶_22]</a>	D-sub socket, 15-pin	1	5 V <sub>DC</sub> , 150 mA	<ul style="list-style-type: none"> <li>• Distributed Clocks</li> <li>• 20 million increments/s</li> <li>• Latch, Gate</li> </ul>

#### Incremental encoder interface with single-ended inputs

Module	Connection encoder/sensor	Number of channels	Sensor supply	Comment
<a href="#">EP5151-0002 [▶_27]</a>	M12 socket, 8-pin	1	24 V <sub>DC</sub> , 0.5 A	<ul style="list-style-type: none"> <li>• Distributed Clocks</li> <li>• 400,000 increments/s</li> <li>• Latch, Gate</li> </ul>

## 3.2 EP5001-0002

### 3.2.1 EP5001-0002 - Introduction

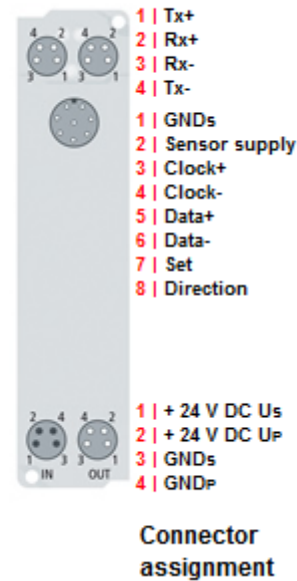
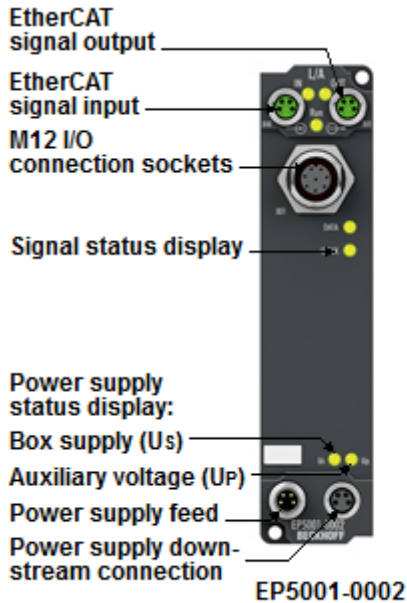

#### SSI encoder interface

The EP5001-0002 EtherCAT box is an SSI master and enables the direct connection of an absolute encoder with SSI (synchronous serial interface). Both singleturn and multiturn encoders are supported. An 8-pin M12 socket is used as encoder connection. The 24 V supply of the encoder is made directly via the M12 socket of the box.

Extensive parameterization allow optimum adaptation to different encoder types.

Special features:

- Baud rate up to max. 1 MHz
- Coding: Gray and binary
- Data length up to 32 bit, flexibly adjustable.
- separate evaluation of a status error bit (power fail bit) in the process data.

Via the distributed clocks function, the position value is read out exactly synchronously with other processes. If the distributed clocks function is deactivated, the EP5001-0002 clocks synchronize with the EtherCAT cycle. The encoder profile enables simple and fast linking of the process data for motion control applications.

#### Quick links

- [Technical data \[▶ 15\]](#)
- [Process image \[▶ 17\]](#)
- [Signal connection \[▶ 38\]](#)
- [Commissioning \[▶ 48\]](#)

### 3.2.2 EP5001-0002 - Technical data

All values are typical values over the entire temperature range, unless stated otherwise.

EtherCAT	
Connection	2 x M8 socket, 4-pin, A-coded, shielded
Electrical isolation	500 V
Distributed Clocks	yes

Supply voltages	
Connection	Input: M8 connector, 4-pin, A-coded Downstream connection: M8 socket, 4-pin, A-coded
$U_S$ nominal voltage	24 V <sub>DC</sub> (-15 % / +20 %)
$U_S$ sum current: $I_{S,sum}$	max. 4 A
Current consumption from $U_S$	130 mA + sensor supply
Rated voltage $U_P$	24 V <sub>DC</sub> (-15 % / +20 %)
$U_P$ sum current: $I_{P,sum}$	max. 4 A
Current consumption from $U_P$	None. $U_P$ is only forwarded.

SSI encoder	
Number of encoder inputs	1
Connection	M12 socket, 8-pin
Signal type	differential (RS422 / RS485)
signals	Data input: Data+, Data- Clock output: Clock+, Clock- The data input has an internal termination resistor of 120 Ω
Sensor supply	24 V <sub>DC</sub> from $U_S$ . max. 0.5 A, short-circuit proof.
Data transfer rates	Adjustable up to 1 MHz. 250 kHz preset.
Serial input	24-bit width (adjustable)
Data direction	Read
Special features	Baud rate, coding and data length are adjustable.

Housing data	
Dimensions W x H x D	30 mm x 126 mm x 26.5 mm (without connectors)
Weight	approx. 165 g
Installation position	variable
Material	PA6 (polyamide)

Environmental conditions	
Ambient temperature during operation	0 ... 55 °C
Ambient temperature during storage	-25 ... +85 °C
Vibration resistance, shock resistance	conforms to EN 60068-2-6 / EN 60068-2-27 Additional checks <a href="#">[► 16]</a>
EMC immunity / emission	conforms to EN 61000-6-2 / EN 61000-6-4
Protection class	IP65, IP66, IP67 (conforms to EN 60529)

Approvals/markings	
Approvals/markings <sup>*)</sup>	CE, cURus <a href="#">[► 42]</a>

\*) Real applicable approvals/markings see type plate on the side (product marking).

### Additional tests

The devices have undergone the following additional tests:

Test	Explanation
Vibration	10 frequency sweeps in 3 axes
	5 Hz < f < 60 Hz displacement 0.35 mm, constant amplitude
	60.1 Hz < f < 500 Hz acceleration 5 g, constant amplitude
Shocks	1000 shocks in each direction, in 3 axes
	35 g, 11 ms

### 3.2.3 EP5001-0002 - Scope of supply

Make sure that the following components are included in the scope of delivery:

- 1x EP5001-0002 EtherCAT Box
- 2x protective cap for EtherCAT socket, M8, green (pre-assembled)
- 1x protective cap for supply voltage input, M8, transparent (pre-assembled)
- 1x protective cap for supply voltage output, M8, black (pre-assembled)
- 10x labels, blank (1 strip of 10)

---

#### **i** Pre-assembled protective caps do not ensure IP67 protection

Protective caps are pre-assembled at the factory to protect connectors during transport. They may not be tight enough to ensure IP67 protection.

Ensure that the protective caps are correctly seated to ensure IP67 protection.

---



### 3.2.4 EP5001-0002 - Process image

TwinCAT displays the process image in a tree structure.

TwinCAT shows the data of the EP5001-0002 in a tree structure.

SSSI Inputs	Status
<ul style="list-style-type: none"> <li>SSSI Inputs                             <ul style="list-style-type: none"> <li>Status                                     <ul style="list-style-type: none"> <li>Data error</li> <li>Frame error</li> <li>Power failure</li> <li>Sync error</li> <li>TxPDO State</li> <li>TxPDO Toggle</li> </ul> </li> <li>Counter value</li> </ul> </li> <li>WcState                             <ul style="list-style-type: none"> <li>WcState</li> <li>InputToggle</li> </ul> </li> <li>InfoData                             <ul style="list-style-type: none"> <li>State</li> </ul> </li> <li>AdsAddr                             <ul style="list-style-type: none"> <li>netId</li> <li>port</li> </ul> </li> </ul>	<ul style="list-style-type: none"> <li><b>Data error</b> SSI input error</li> <li><b>Frame error</b> Wrong data frame</li> <li><b>Power failure</b> An encoder-specific error has occurred. Enabling through <i>Enable Power failure bit</i> (index 0x8000:02)</li> <li><b>Sync error</b> EtherCAT error, see <a href="#">EtherCAT system documentation</a></li> <li><b>TxPDO State</b> See <a href="#">object description [▶ 81]</a></li> <li><b>TxPDO Toggle</b> See <a href="#">object description [▶ 81]</a></li> </ul>
Counter value	Counter value

## 3.3 EP5101-x002

### 3.3.1 EP5101-x002 - Introduction

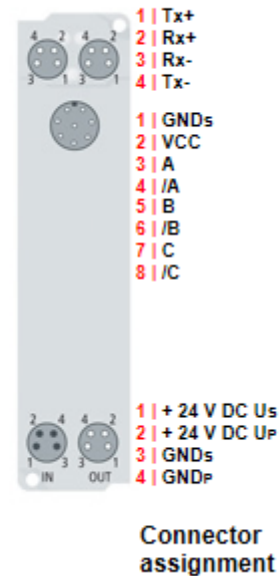
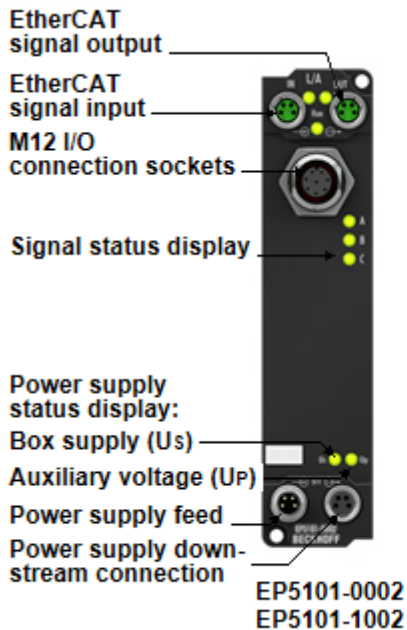

#### Incremental encoder interface with differential inputs

The EP5101-x002 EtherCAT Box is an interface for the direct connection of incremental encoders with differential signals (RS422) or TTL single ended signals. Input frequencies up to 1 MHz can be evaluated. The C input can optionally be used as a latch input. The supply of the encoder is directly via the M12 socket of the EP5101-x002.

Special features:

- save, lock, set counter
- integrated frequency and period measurement
- optionally usable as 5 V counter
- Microincrements
- synchronous reading of the position value via distributed clocks
- Timestamp on the last-registered incremental edge

In addition, the EP5101-x002 enables the measurement of a period or frequency with a resolution of 100 ns. With the optional interpolating microincrement functionality, the EP5101-x002 can provide even more accurate axis positions for dynamic axes. It also supports synchronous reading of the encoder value together with other input data in the EtherCAT system via the high-precision EtherCAT distributed clocks (DC). A timestamp for the last-registered incremental edge is also available. The use of encoder profiles enables simple and fast linking of the process data for Motion Control applications.

#### Quick links

- [Technical data \[▶ 19\]](#)
- [Process image \[▶ 21\]](#)
- [Signal connection \[▶ 39\]](#)
- [Commissioning \[▶ 54\]](#)

### 3.3.2 EP5101-x002 - Technical data

All values are typical values over the entire temperature range, unless stated otherwise.

EtherCAT	
Connection	2 x M8 socket, 4-pin, A-coded, shielded
Electrical isolation	500 V
Distributed Clocks	yes

Supply voltages	
Connection	Input: M8 connector, 4-pin, A-coded Downstream connection: M8 socket, 4-pin, A-coded
$U_S$ nominal voltage	24 V <sub>DC</sub> (-15 % / +20 %)
$U_S$ sum current: $I_{S,sum}$	max. 4 A
Current consumption from $U_S$	130 mA + sensor supply
Rated voltage $U_P$	24 V <sub>DC</sub> (-15 % / +20 %)
$U_P$ sum current: $I_{P,sum}$	max. 4 A
Current consumption from $U_P$	None. $U_P$ is only forwarded.

Incremental encoders	EP5101-0002	EP5101-1002
Number of encoder inputs	1	
Connection	M12 socket, 8-pin [► 39]	
signals	A, /A, B, /B, C, /C (RS422 / RS485 differential inputs) Also single-ended connection (5 V ±20%) possible.	
Sensor supply Vcc	5 V <sub>DC</sub> from $U_S$ . max. 150 mA	24 V <sub>DC</sub> from $U_S$ . max. 0.5 A, short-circuit proof
Counter	32-bit or 16-bit, binary	
Cut-off frequency	4 million increments/s (with four-fold evaluation)	
Quadrature decoder	Four-fold evaluation	
Zero-pulse latch	16-bit	
Commands	read, set, enable	

Housing data	
Dimensions W x H x D	30 mm x 126 mm x 26.5 mm (without connectors)
Weight	approx. 165 g
Installation position	variable
Material	PA6 (polyamide)

Environmental conditions	EP5101-0002	EP5101-1002
Ambient temperature during operation	-25...+60 °C -25...+55 °C according to cURus 0...+55 °C according to ATEX	-25...+60 °C -25...+55 °C according to cURus
Ambient temperature during storage	-40...+85 °C	
Vibration resistance, shock resistance	conforms to EN 60068-2-6 / EN 60068-2-27 Additional checks [► 20]	
EMC immunity / emission	conforms to EN 61000-6-2 / EN 61000-6-4	
Protection class	IP65, IP66, IP67 (conforms to EN 60529)	

Approvals/markings	EP5101-0002	EP5101-1002
Approvals/markings	ATEX, CE, cURus [▶ 42], EAC, UKCA	CE, cURus [▶ 42], EAC, UKCA

### Additional tests

The devices have undergone the following additional tests:

Test	Explanation
Vibration	10 frequency sweeps in 3 axes
	5 Hz < f < 60 Hz displacement 0.35 mm, constant amplitude
	60.1 Hz < f < 500 Hz acceleration 5 g, constant amplitude
Shocks	1000 shocks in each direction, in 3 axes
	35 g, 11 ms

### 3.3.3 EP5101-x002 - Scope of supply

Make sure that the following components are included in the scope of delivery:

- 1x EP5101-x002 EtherCAT Box
- 2x protective cap for EtherCAT socket, M8, green (pre-assembled)
- 1x protective cap for supply voltage input, M8, transparent (pre-assembled)
- 1x protective cap for supply voltage output, M8, black (pre-assembled)
- 10x labels, blank (1 strip of 10)

































#### Pre-assembled protective caps do not ensure IP67 protection

Protective caps are pre-assembled at the factory to protect connectors during transport. They may not be tight enough to ensure IP67 protection.

Ensure that the protective caps are correctly seated to ensure IP67 protection.

### 3.3.4 EP5101-x002 - Process image

TwinCAT shows the data of the EP5101-0002 and EP5101-1002 in a tree structure, using the EP5101-0002 as an example.

<ul style="list-style-type: none"> <li>▲  Box 1 (EP5101-0002)             <ul style="list-style-type: none"> <li>▲  ENC Status compact                 <ul style="list-style-type: none"> <li>▲  Status                     <ul style="list-style-type: none"> <li> Latch C valid</li> <li> Set counter done</li> <li> Counter underflow</li> <li> Counter overflow</li> <li> Open circuit</li> <li> Extrapolation stall</li> <li> Status of input A</li> <li> Status of input B</li> <li> Status of input C</li> <li> Sync error</li> <li> TxPDO State</li> <li> TxPDO Toggle</li> <li> Counter value</li> <li> Latch value</li> </ul> </li> <li>▲  ENC Control compact                     <ul style="list-style-type: none"> <li>▲  Control                         <ul style="list-style-type: none"> <li> Enable latch C</li> <li> Set counter</li> <li> Set counter value</li> </ul> </li> </ul> </li> <li>▲  WcState                     <ul style="list-style-type: none"> <li> WcState</li> <li> InputToggle</li> </ul> </li> <li>▲  InfoData                     <ul style="list-style-type: none"> <li> State</li> <li>▲  AdsAddr                         <ul style="list-style-type: none"> <li> netId</li> <li> port</li> </ul> </li> </ul> </li> </ul> </li> </ul> </li> </ul>	<p><b>ENC Status Compact</b></p> <p><b>Status</b></p> <ul style="list-style-type: none"> <li>• <b>Latch C valid</b></li> <li>• <b>Set Counter done</b></li> <li>• <b>Counter underflow</b></li> <li>• <b>Counter overflow</b></li> <li>• <b>Open circuit</b></li> <li>• <b>Extrapolation stall</b></li> <li>• <b>Status of Input A, B,C</b></li> <li>• <b>Sync error</b></li> <li>• <b>TxPDO State</b></li> <li>• <b>TxPDO Toggle</b></li> </ul> <p><b>Counter value</b></p> <p><b>Latch value</b></p> <p><b>ENC Control Compact</b></p> <p><b>Control</b></p> <ul style="list-style-type: none"> <li>• <b>Enable latch C</b></li> <li>• <b>Set counter</b></li> </ul> <p><b>Set Counter value</b></p>	<p>Input data of the encoder interface</p> <p>New data are available in the process data <i>Latch value</i>. Reset via <i>Enable latch C</i></p> <p>Acknowledgement for setting the <i>Set counter</i></p> <p>The counter is lower than the lowest counter value that can be displayed</p> <p>The counter is higher than the highest counter value that can be displayed</p> <p>One of the channels (A, B or C) has an open circuit (configurable for each channel via CoE)</p> <p>Micro-increment value invalid (when micro-increment evaluation is enabled -&gt; index 0x8000:0A)</p> <p>Status of inputs A, B and C</p> <p>EtherCAT error, see <a href="#">EtherCAT system documentation</a></p> <p>See <a href="#">object description [p. 85]</a></p> <p>See <a href="#">object description [p. 85]</a></p> <p>Current encoder counter value</p> <p>Counter value of the encoder with rising edge at the latch input</p> <p>Output data of the encoder interface.</p> <p>Input C is activated. When an edge is encountered, the <i>Counter value</i> is stored in <i>Latch value</i>.</p> <p>When a positive edge is encountered, the <i>Set counter value</i> is transferred to the <i>Counter value</i></p> <p>Preselection value for <i>Counter value</i></p>
---	--	--

## 3.4 EP5101-x011

### 3.4.1 EP5101-x011 - Introduction

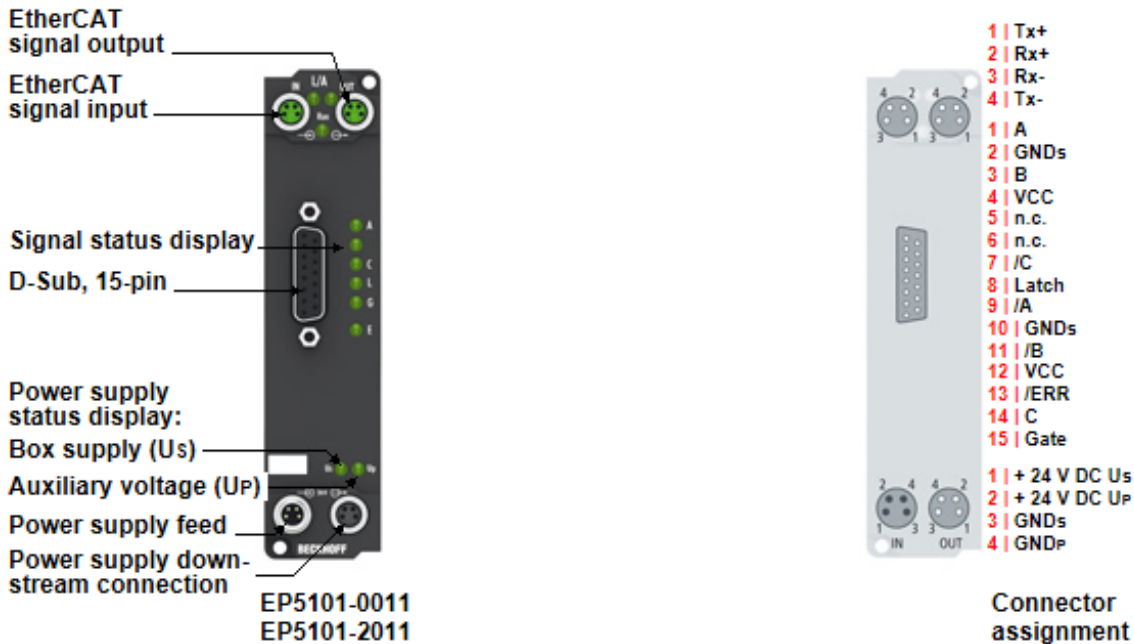

#### Incremental encoder interface with differential inputs

The EP5101-x011 EtherCAT Box is an interface for the direct connection of incremental encoders with differential signals (RS422) or TTL single ended signals. Two additional 24 V digital inputs are available for storing, locking and setting the counter reading. The error message output of an encoder can be connected and evaluated via the status input. The 5 V supply of the encoder is directly provided via the D-Sub socket of the EP5101-x011.

Special features:

- save, lock, set counter
- integrated frequency and period measurement
- optionally usable as 5 V counter
- Microincrements
- synchronous reading of the position value via distributed clocks
- Timestamp on the last-registered incremental edge
- 20 MHz cut-off frequency (EP5101-2011)

In addition, the EP5101-x011 enables the measurement of a period or frequency with a resolution of 100 ns. With the optional interpolating microincrement functionality, the EP5101-x011 can provide even more accurate axis positions for dynamic axes. It also supports synchronous reading of the encoder value together with other input data in the EtherCAT system via the high-precision EtherCAT distributed clocks (DC). A timestamp for the last-registered incremental edge is also available. The use of encoder profiles enables simple and fast linking of the process data for Motion Control applications.

#### Quick links

[Technical data](#) [▶ 23]

[Process image EP5101-0011](#) [▶ 25]

[Process image EP5101-2011](#) [▶ 26]

[Signal connection](#) [▶ 40]

### 3.4.2 EP5101-x011 - Technical data

All values are typical values over the entire temperature range, unless stated otherwise.

EtherCAT	
Connection	2 x M8 socket, 4-pin, A-coded, shielded
Electrical isolation	500 V
Distributed Clocks	yes

Supply voltages	
Connection	Input: M8 connector, 4-pin, A-coded Downstream connection: M8 socket, 4-pin, A-coded
$U_S$ nominal voltage	24 V <sub>DC</sub> (-15 % / +20 %)
$U_S$ sum current: $I_{S,sum}$	max. 4 A
Current consumption from $U_S$	130 mA + sensor supply
Rated voltage $U_P$	24 V <sub>DC</sub> (-15 % / +20 %)
$U_P$ sum current: $I_{P,sum}$	max. 4 A
Current consumption from $U_P$	None. $U_P$ is only forwarded.

Incremental encoders	EP5101-0011	EP5101-2011
Number of encoder inputs	1	
Connection	D-sub socket, 15-pin [► 39]	
signals	A, /A, B, /B, C, /C (RS422 / RS485 differential inputs) Also single-ended connection (5 V ±20%) possible. Latch, Gate	
Sensor supply Vcc	5 V <sub>DC</sub> from $U_S$ . max. 150 mA	
Counter	32-bit or 16-bit, binary	
Cut-off frequency	4 million increments/s (with four-fold evaluation)	20 million increments/s (with four-fold evaluation)
Quadrature decoder	Four-fold evaluation	
Zero-pulse latch	16-bit	
Commands	read, set, enable	

Housing data	
Dimensions W x H x D	30 mm x 126 mm x 26.5 mm (without connectors)
Weight	approx. 165 g
Installation position	variable
Material	PA6 (polyamide)

Environmental conditions	
Ambient temperature during operation	-25 ... +60 °C -25 ... +55 °C according to cURus
Ambient temperature during storage	-40 ... +85 °C
Vibration resistance, shock resistance	conforms to EN 60068-2-6 / EN 60068-2-27 Additional tests [► 24]
EMC immunity / emission	conforms to EN 61000-6-2 / EN 61000-6-4
Protection class	IP65, IP66, IP67 (conforms to EN 60529)

Approvals/markings	
Approvals/markings *)	CE, cURus [► 42]

\*) Real applicable approvals/markings see type plate on the side (product marking).

### Additional tests

The devices have undergone the following additional tests:

Test	Explanation
Vibration	10 frequency sweeps in 3 axes
	5 Hz < f < 60 Hz displacement 0.35 mm, constant amplitude
	60.1 Hz < f < 500 Hz acceleration 5 g, constant amplitude
Shocks	1000 shocks in each direction, in 3 axes
	35 g, 11 ms

### 3.4.3 EP5101-x011 - Scope of supply

Make sure that the following components are included in the scope of delivery:

- 1x EtherCAT Box EP5101-x011
- 2x protective cap for EtherCAT socket, M8, green (pre-assembled)
- 1x protective cap for supply voltage input, M8, transparent (pre-assembled)
- 1x protective cap for supply voltage output, M8, black (pre-assembled)
- 10x labels, blank (1 strip of 10)

#### ● **Pre-assembled protective caps do not ensure IP67 protection**

**i** Protective caps are pre-assembled at the factory to protect connectors during transport. They may not be tight enough to ensure IP67 protection.

Ensure that the protective caps are correctly seated to ensure IP67 protection.



### 3.4.4 EP5101-0011 - Process image

TwinCAT shows the data of the EP5101-0011 in a tree structure.

<ul style="list-style-type: none"> <li>Box 1 (EP5101-0011)             <ul style="list-style-type: none"> <li>ENC Status compact                 <ul style="list-style-type: none"> <li>Status                     <ul style="list-style-type: none"> <li>Latch C valid</li> <li>Latch extern valid</li> <li>Set counter done</li> <li>Counter underflow</li> <li>Counter overflow</li> <li>Status of input status</li> <li>Open circuit</li> <li>Extrapolation stall</li> <li>Status of input A</li> <li>Status of input B</li> <li>Status of input C</li> <li>Status of input gate</li> <li>Status of extern latch</li> <li>Sync error</li> <li>TxPDO State</li> <li>TxPDO Toggle</li> <li>Counter value</li> <li>Latch value</li> </ul> </li> <li>ENC Control compact                     <ul style="list-style-type: none"> <li>Control                         <ul style="list-style-type: none"> <li>Enable latch C</li> <li>Enable latch extern on positive edge</li> <li>Set counter</li> <li>Enable latch extern on negative edge</li> <li>Set counter value</li> </ul> </li> </ul> </li> <li>WcState                     <ul style="list-style-type: none"> <li>WcState</li> <li>InputToggle</li> </ul> </li> <li>InfoData                     <ul style="list-style-type: none"> <li>State</li> <li>AdsAddr                         <ul style="list-style-type: none"> <li>netId</li> <li>port</li> </ul> </li> </ul> </li> </ul> </li> </ul> </li> </ul>	<p style="text-align: center;"><b>ENC Status Compact</b></p> <p><b>Status</b></p> <ul style="list-style-type: none"> <li>• <b>Latch C valid</b>      New data are available in the process data <i>Latch value</i>. Reset via <i>Enable latch C</i></li> <li>• <b>Latch extern valid</b>      New data are available in the process data <i>Latch value</i>. Reset through <i>Enable latch extern on positive/negative edge</i></li> <li>• <b>Set counter done</b>      Acknowledgement for setting the <i>Set counter</i></li> <li>• <b>Counter underflow</b>      The counter is lower than the lowest counter value that can be displayed</li> <li>• <b>Counter overflow</b>      The counter is higher than the highest counter value that can be displayed</li> <li>• <b>Status of input status</b>      Status of the error signal (typically from the encoder)</li> <li>• <b>Open circuit</b>      One of the channels (A, B or C) has an open circuit (configurable for each channel via CoE)</li> <li>• <b>Extrapolation stall</b>      Micro-increment value invalid (when micro-increment evaluation is enabled -&gt; index 0x8000:0A)</li> <li>• <b>Status of Input A, B,C</b>      Status of inputs A, B, and C</li> <li>• <b>Status of input gate</b>      Status of the gate input</li> <li>• <b>Status of extern latch</b>      Status of the latch input</li> <li>• <b>Sync error</b>      EtherCAT error, see <a href="#">EtherCAT system documentation</a></li> <li>• <b>TxPDO State</b>      See <a href="#">object description [► 85]</a></li> <li>• <b>TxPDO Toggle</b>      See <a href="#">object description [► 85]</a></li> </ul> <p><b>Counter value</b> Current encoder counter value</p> <p><b>Latch value</b> Counter value of the encoder with rising edge at the latch input</p> <p><b>ENC Control Compact</b></p> <p><b>Control</b></p> <ul style="list-style-type: none"> <li>• <b>Enable latch C</b>      Input C is activated. When an edge is encountered, the <i>Counter value</i> is stored in <i>Latch value</i>.</li> <li>• <b>Enable latch extern on positive edge</b>      External latch input is enabled. When a positive edge is encountered, the <i>Counter value</i> is stored in <i>Latch value</i>.</li> <li>• <b>Set counter</b>      When a positive edge is encountered, the <i>Set counter value</i> is transferred to the <i>Counter value</i></li> <li>• <b>Enable latch extern on negative edge</b>      External latch input is enabled. When a negative edge is encountered, the <i>Counter value</i> is stored in <i>Latch value</i>.</li> </ul> <p><b>Set counter value</b> Preselection value for <i>Counter value</i></p>
--	--

### 3.4.5 EP5101-2011 - Process image

TwinCAT shows the data of the EP5101-2011 in a tree structure.

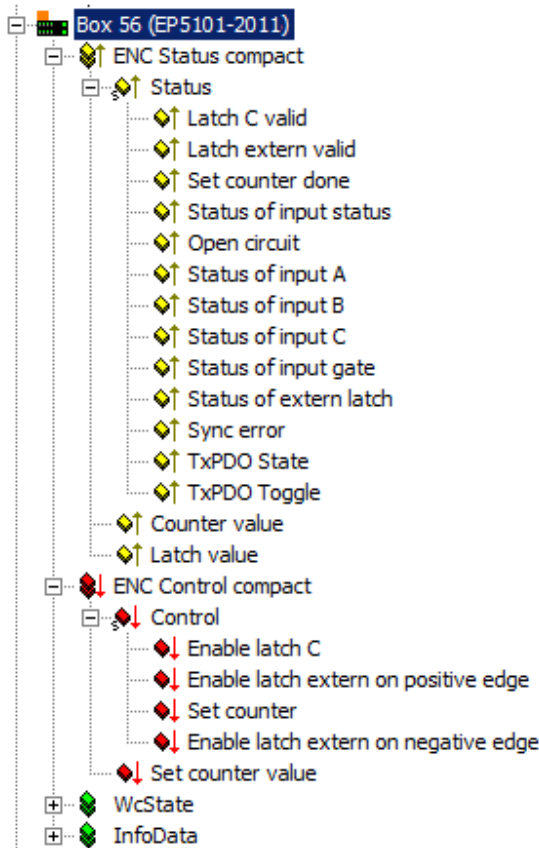

#### ENC Status Compact

##### Status

- **Latch C valid** New data are available in the process data *Latch value*. Reset via *Enable latch C*
- **Latch extern valid** New data are available in the process data *Latch value*. Reset through *Enable latch extern on positive/negative edge*
- **Set Counter done** Acknowledgement for setting the *Set counter*
- **Status of input status** Status of the error signal (typically from the encoder)
- **Open circuit** One of the channels (A, B or C) has an open circuit (configurable for each channel via CoE)
- **Status of Input A, B,C** Status of inputs A, B and C
- **Status of input gate** Status of the gate input
- **Status of extern latch** Status of the latch input
- **Sync error** EtherCAT error, see [EtherCAT system documentation](#)
- **TxPDO State** See object description
- **TxPDO Toggle** See object description

##### Counter value

Current encoder counter value

##### Latch value

Counter value of the encoder with rising edge at the latch input

#### ENC Control Compact

Output data of the encoder interface.

##### Control

- **Enable latch C** Input C is activated. When an edge is encountered, the *Counter value* is stored in *Latch value*.
- **Enable latch extern on positive edge** External latch input is enabled. When a positive edge is encountered, the *Counter value* is stored in *Latch value*.
- **Set counter** When a positive edge is encountered, the *Set counter value* is transferred to the *Counter value*
- **Enable latch extern on negative edge** External latch input is enabled. When a negative edge is encountered, the *Counter value* is stored in *Latch value*.

##### Set Counter value

Preselection value for *Counter value*

### 3.5 EP5151-0002

#### 3.5.1 EP5151-0002 – Introduction

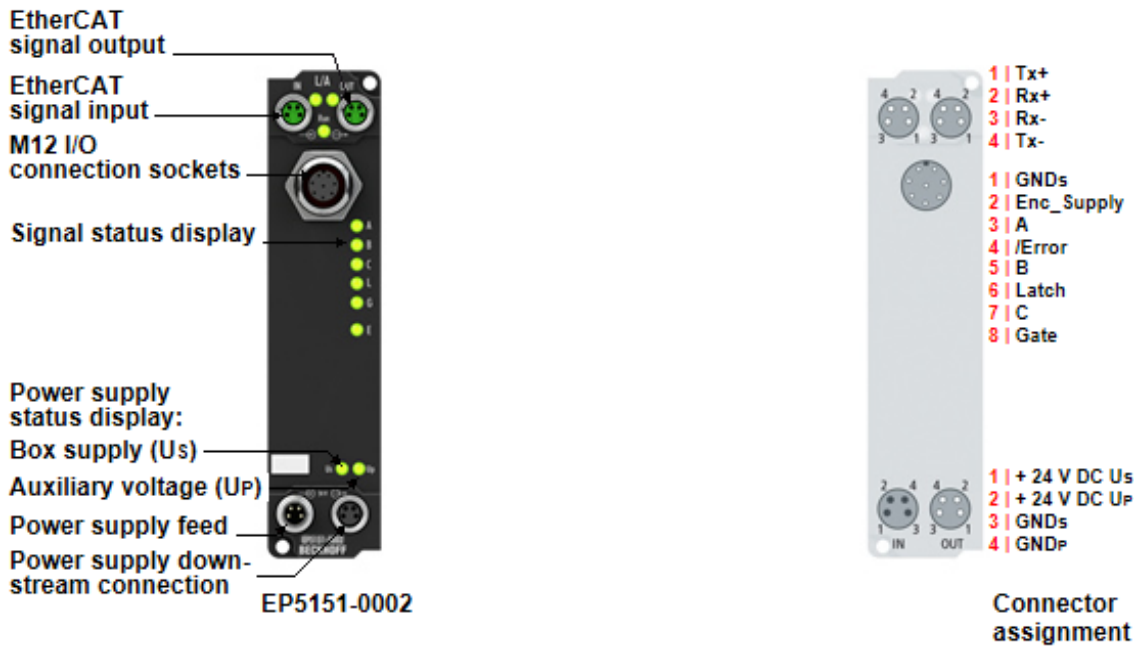

#### 1-channel encoder interface, incremental, 24 V<sub>DC</sub> HTL, 100 kHz, M12

The EP5151-0002 EtherCAT Box module is an interface for direct connection of 24 V DC single-ended signals. Two additional 24 V digital inputs are available for saving, locking, and setting the counter value. The alarm output of an encoder can be connected and evaluated via the status input. The encoder is supplied with 24 V directly via the M12 socket of the EPP5151-0002.

Special features:

- save, lock, and set the counter
- integrated frequency and period measurement
- can optionally be used as 5 V counter
- microincrements
- synchronous reading of the position value via distributed clocks
- timestamp on the last registered incremental edge

In addition, the EP5151-0002 allows measurement of a period or frequency. Due to the optional interpolating microincrements functionality, the EP5151-0002 can supply even more precise axis positions for dynamic axes. In addition, it supports synchronous reading of the encoder value together with other input data in the EtherCAT system via the high-precision EtherCAT Distributed Clocks (DC). In addition, timestamps are available for the last registered incremental edge. The use of encoder profiles allows the process data to be linked to the motion control application quickly and easily.

#### Quick links

- [Technical data \[▶ 28\]](#)
- [Process image \[▶ 30\]](#)
- [Signal connection \[▶ 41\]](#)
- [Commissioning \[▶ 54\]](#)

### 3.5.2 EP5151-0002 - Technical data

All values are typical values over the entire temperature range, unless stated otherwise.

EtherCAT	
Connection	2 x M8 socket, 4-pin, A-coded, shielded
Electrical isolation	500 V
Distributed Clocks	yes

Supply voltages	
Connection	Input: M8 connector, 4-pin, A-coded Downstream connection: M8 socket, 4-pin, A-coded
$U_S$ nominal voltage	24 V <sub>DC</sub> (-15 % / +20 %)
$U_S$ sum current: $I_{S,sum}$	max. 4 A
Current consumption from $U_S$	130 mA + sensor supply
Rated voltage $U_P$	24 V <sub>DC</sub> (-15 % / +20 %)
$U_P$ sum current: $I_{P,sum}$	max. 4 A
Current consumption from $U_P$	None. $U_P$ is only forwarded.

Incremental encoders	
Number of encoder inputs	1
Connection	M12 socket, 8-pin [► 41]
Signals	A, B, C (24 V <sub>DC</sub> , single-ended), latch, gate HTL signal level (push-pull) [► 74]
"ENC_Supply" sensor power supply	24 V <sub>DC</sub> from $U_S$
Counter	32 bit or 16 bit, binary
Cut-off frequency	400,000 increments/s (with 4-fold evaluation), corresponds to 100 kHz
Quadrature decoder	Four-fold evaluation
Zero-pulse latch	16-bit
Commands	Read, set, enable

Housing data	
Dimensions W x H x D	30 mm x 126 mm x 26.5 mm (without connectors)
Weight	approx. 165 g
Installation position	variable
Material	PA6 (polyamide)

Environmental conditions	
Ambient temperature during operation	0 ... 55 °C
Ambient temperature during storage	-25 ... +85 °C
Vibration resistance, shock resistance	conforms to EN 60068-2-6 / EN 60068-2-27 Additional checks [► 29]
EMC immunity / emission	conforms to EN 61000-6-2 / EN 61000-6-4
Protection class	IP65, IP66, IP67 (conforms to EN 60529)

Approvals/markings	
Approvals/markings *)	CE, cURus [► 42]

\*) Real applicable approvals/markings see type plate on the side (product marking).

**Additional tests**

The devices have undergone the following additional tests:

Test	Explanation
Vibration	10 frequency sweeps in 3 axes
	5 Hz < f < 60 Hz displacement 0.35 mm, constant amplitude
	60.1 Hz < f < 500 Hz acceleration 5 g, constant amplitude
Shocks	1000 shocks in each direction, in 3 axes
	35 g, 11 ms

**3.5.3 EP5151-0002 - Scope of supply**

Make sure that the following components are included in the scope of delivery:

- 1x EtherCAT Box EP5151-0002
- 2x protective cap for EtherCAT socket, M8, green (pre-assembled)
- 1x protective cap for supply voltage input, M8, transparent (pre-assembled)
- 1x protective cap for supply voltage output, M8, black (pre-assembled)
- 10x labels, blank (1 strip of 10)

---

**● Pre-assembled protective caps do not ensure IP67 protection**

**i** Protective caps are pre-assembled at the factory to protect connectors during transport. They may not be tight enough to ensure IP67 protection.

Ensure that the protective caps are correctly seated to ensure IP67 protection.

---

### 3.5.4 EP5151-0002 - Process image

- ENC Status compact
      - Status
        - Latch C valid
        - Latch extern valid
        - Set counter done
        - Counter underflow
        - Counter overflow
        - Status of input status
        - Open circuit
        - Extrapolation stall
        - Status of input A
        - Status of input B
        - Status of input C
        - Status of input gate
        - Status of extern latch
        - Sync error
        - TxPDO State
        - TxPDO Toggle
      - Counter value
      - Latch value
    - ENC Control compact
      - Control
        - Enable latch C
        - Enable latch extern on positive edge
        - Set counter
        - Enable latch extern on negative edge
        - Set counter value
    - WcState
      - WcState
      - InputToggle
    - InfoData
      - State
      - AdsAddr
        - netId
        - port

#### ENC Status Compact

##### Status

- **Latch C valid** New data are available in the process data *Latch value*. Reset via *Enable latch C*
- **Latch extern valid** New data are available in the process data *Latch value*. Reset through *Enable latch extern on positive/negative edge*
- **Set Counter done** Acknowledgement for setting the *Set counter*
- **Counter underflow** The counter is lower than the lowest counter value that can be displayed
- **Counter overflow** The counter is higher than the highest counter value that can be displayed
- **Status of input status** Status of the error signal (typically from the encoder)
- **Open circuit** One of the channels (A, B or C) has an open circuit (configurable for each channel via CoE)
- **Extrapolation stall** Micro-increment value invalid (when micro-increment evaluation is enabled -> index 0x8000:0A)
- **Status of Input A, B,C** Status of inputs A, B and C
- **Status of input gate** Status of the gate input
- **Status of extern latch** Status of the latch input
- **Sync error** EtherCAT error, see [EtherCAT system documentation](#)
- **TxPDO State** See [object description \[► 113\]](#)
- **TxPDO Toggle** See [object description \[► 113\]](#)

##### Counter value

Current encoder counter value

##### Latch value

Counter value of the encoder with rising edge at the latch input

#### ENC Control Compact

##### Control

- **Enable latch C** Input C is activated. When an edge is encountered, the *Counter value* is stored in *Latch value*.
- **Enable latch extern on positive edge** External latch input is enabled. When a positive edge is encountered, the *Counter value* is stored in *Latch value*.
- **Set counter** When a positive edge is encountered, the *Set counter value* is transferred to the *Counter value*
- **Enable latch extern on negative edge** External latch input is enabled. When a negative edge is encountered, the *Counter value* is stored in *Latch value*.

##### Set Counter value

Preselection value for *Counter value*

## 4 Mounting and connection

### 4.1 Mounting

#### 4.1.1 Dimensions

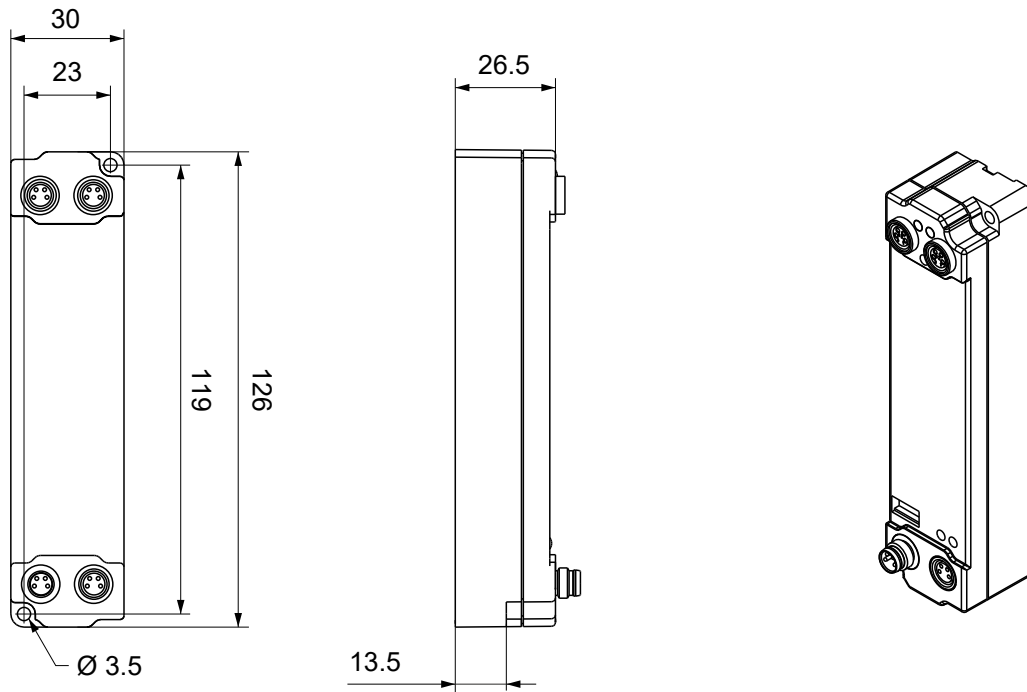

All dimensions are given in millimeters.  
The drawing is not true to scale.

#### Housing features

Housing material	PA6 (polyamide)
Sealing compound	polyurethane
Mounting	two mounting holes $\varnothing 3.5$ mm for M3
Metal parts	brass, nickel-plated
Contacts	CuZn, gold-plated
Power feed through	max. 4 A
Installation position	variable
Protection class	IP65, IP66, IP67 (conforms to EN 60529) when screwed together
Dimensions (H x W x D)	approx. 126 x 30 x 26.5 mm (without connectors)

## 4.1.2 Fixing

### **NOTICE**

#### **Dirt during assembly**

Dirty connectors can lead to malfunctions. Protection class IP67 can only be guaranteed if all cables and connectors are connected.

- Protect the plug connectors against dirt during the assembly.

Mount the module with two M3 screws on the mounting holes in the corners of the module. The mounting holes have no thread.

## 4.1.3 Tightening torques for plug connectors

Screw M8 connectors tight with a torque wrench. (e.g. ZB8801 from Beckhoff)

Torque: 0.4 Nm.



## 4.2 EtherCAT

### 4.2.1 Connectors

**NOTICE**

**Risk of confusion: supply voltages and EtherCAT**

Defect possible through incorrect insertion.

- Observe the color coding of the connectors:  
 black: Supply voltages  
 green: EtherCAT

EtherCAT Box Modules have two green M8 sockets for the incoming and downstream EtherCAT connections.



**Connection**

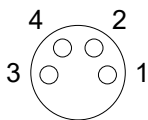

Fig. 4: M8 socket

EtherCAT	M8 socket	Core colors		
Signal	Contact	ZB9010, ZB9020, ZB9030, ZB9032, ZK1090-6292, ZK1090-3xxx-xxxx	ZB9031 and old versions of ZB9030, ZB9032, ZK1090-3xxx-xxxx	TIA-568B
Tx +	1	yellow <sup>1)</sup>	orange/white	white/orange
Tx -	4	orange <sup>1)</sup>	orange	orange
Rx +	2	white <sup>1)</sup>	blue/white	white/green
Rx -	3	blue <sup>1)</sup>	blue	green
Shield	Housing	Shield	Shield	Shield

<sup>1)</sup> Core colors according to EN 61918

**● Adaptation of core colors for cables ZB9030, ZB9032 and ZK1090-3xxxx-xxxx**

**i** For standardization, the core colors of the ZB9030, ZB9032 and ZK1090-3xxx-xxxx cables have been changed to the EN61918 core colors: yellow, orange, white, blue. So there are different color codes in circulation. The electrical properties of the cables have been retained when the core colors were changed.

## 4.2.2 Status LEDs



### L/A (Link/Act)

A green LED labelled "L/A" is located next to each EtherCAT socket. The LED indicates the communication state of the respective socket:

LED	Meaning
off	no connection to the connected EtherCAT device
lit	LINK: connection to the connected EtherCAT device
flashes	ACT: communication with the connected EtherCAT device

### Run

Each EtherCAT slave has a green LED labelled "Run". The LED signals the status of the slave in the EtherCAT network:

LED	Meaning
off	Slave is in "Init" state
flashes uniformly	Slave is in "Pre-Operational" state
flashes sporadically	Slave is in "Safe-Operational" state
lit	Slave is in "Operational" state

Description of the EtherCAT slave states

## 4.2.3 Cables

For connecting EtherCAT devices only shielded Ethernet cables that meet the requirements of at least category 5 (CAT5) according to EN 50173 or ISO/IEC 11801 should be used.

EtherCAT uses four wires for signal transmission.

Thanks to automatic line detection ("Auto MDI-X"), both symmetrical (1:1) or cross-over cables can be used between Beckhoff EtherCAT.

Detailed recommendations for the cabling of EtherCAT devices

## 4.3 Supply voltages

### ⚠ WARNING

#### Power supply from SELV/PELV power supply unit!

SELV/PELV circuits (Safety Extra Low Voltage, Protective Extra Low Voltage) according to IEC 61010-2-201 must be used to supply this device.

Notes:

- SELV/PELV circuits may give rise to further requirements from standards such as IEC 60204-1 et al, for example with regard to cable spacing and insulation.
- A SELV (Safety Extra Low Voltage) supply provides safe electrical isolation and limitation of the voltage without a connection to the protective conductor, a PELV (Protective Extra Low Voltage) supply also requires a safe connection to the protective conductor.

### ⚠ CAUTION

#### Observe the UL requirements

- When operating under UL conditions, observe the warnings in the chapter [UL Requirements](#) [► 42].

The EtherCAT Box has one input for two supply voltages:

- **Control voltage  $U_s$**   
The following sub-functions are supplied from the control voltage  $U_s$ :
  - the fieldbus
  - the processor logic
  - typically the inputs and the sensors if the EtherCAT Box has inputs.
- **Peripheral voltage  $U_p$**   
For EtherCAT Box modules with digital outputs the digital outputs are typically supplied from the peripheral voltage  $U_p$ .  $U_p$  can be supplied separately. If  $U_p$  is switched off, the fieldbus function, the function of the inputs and the supply of the sensors are maintained.

The exact assignment of  $U_s$  and  $U_p$  can be found in the pin assignment of the I/O connections.

#### Redirection of the supply voltages

The power IN and OUT connections are bridged in the module. Hence, the supply voltages  $U_s$  and  $U_p$  can be passed from EtherCAT Box to EtherCAT Box in a simple manner.

### NOTICE

#### Note the maximum current!

Ensure that the permitted current for the connectors is not exceeded when routing the supply voltages  $U_s$  and  $U_p$ :

M8 connector: max. 4 A  
7/8" connector: max 16 A

### NOTICE

#### Unintentional cancellation of the electrical isolation possible

In some types of EtherCAT Box modules the ground potentials  $GND_s$  and  $GND_p$  are connected.

- If several EtherCAT Box modules are supplied with the same electrically isolated voltages, check whether there is an EtherCAT Box among them in which the ground potentials are connected.

### 4.3.1 Connectors

**NOTICE**

**Risk of confusion: supply voltages and EtherCAT**  
 Defect possible through incorrect insertion.

- Observe the color coding of the connectors:  
 black: Supply voltages  
 green: EtherCAT

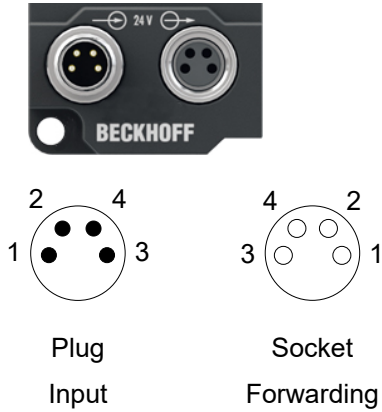

Fig. 5: M8 connector

Contact	Function	Description	Core color <sup>1)</sup>
1	$U_s$	Control voltage	Brown
2	$U_p$	Peripheral voltage	White
3	$GND_s$	GND to $U_s$	Blue
4	$GND_p$	GND to $U_p$	Black

<sup>1)</sup> The core colors apply to cables of the type: Beckhoff ZK2020-3xxx-xxxx

### 4.3.2 Status LEDs



LED	Display	Meaning
$U_s$ (control voltage)	off	The supply voltage $U_s$ is not available.
	green illuminated	The supply voltage $U_s$ is available.
$U_p$ (peripheral voltage)	off	The supply voltage $U_p$ is not available.
	green illuminated	The supply voltage $U_p$ is available.

### 4.3.3 Conductor losses

Take into account the voltage drop on the supply line when planning a system. Avoid the voltage drop being so high that the supply voltage at the box lies below the minimum nominal voltage. Variations in the voltage of the power supply unit must also be taken into account.

#### Voltage drop on the supply line

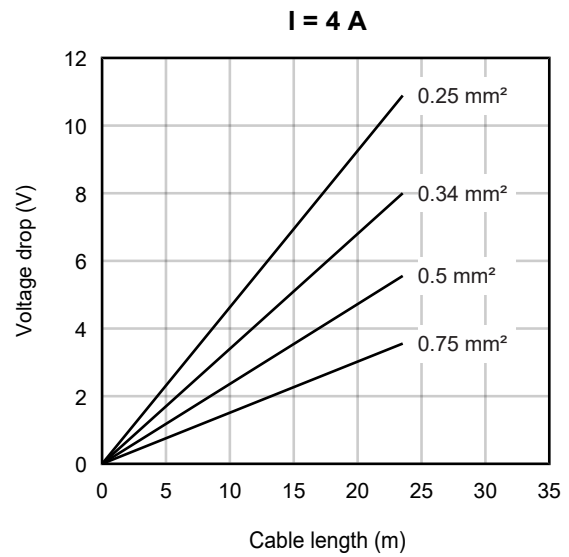
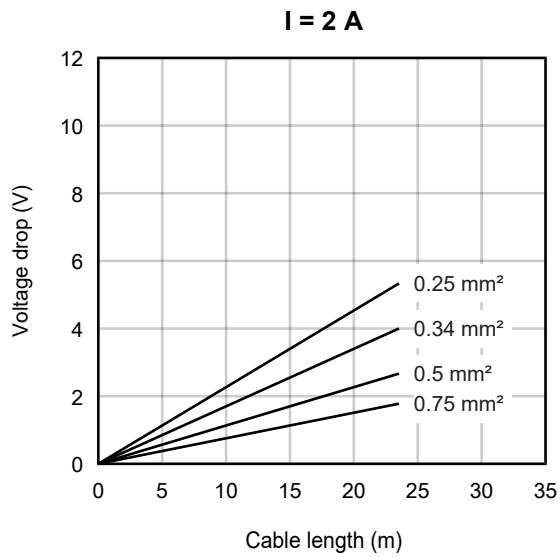

## 4.4 Signal connection and meaning of the LEDs

### 4.4.1 Shielding

**i** **Shielding**

Encoder, analog sensors and actuators should always be connected with shielded, twisted paired wires.

### 4.4.2 EP5001-0002 - Signal connection

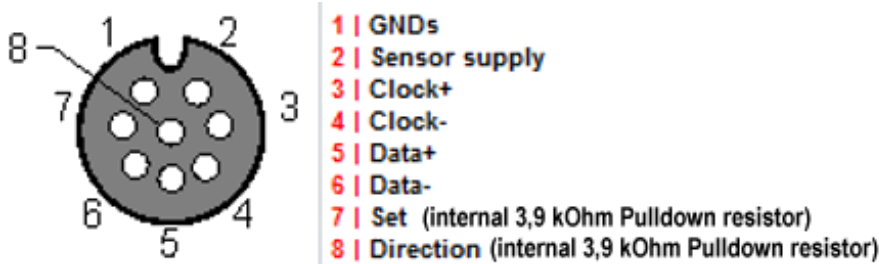

#### LED indicators - meanings



LED	green	red
Data	Encoder supply switched on (operational state, not short-circuited)	SSI without power supply Open circuit on the SSI data input D+ or D- Data cables interchanged The SSI input is at Low level, no data transfer takes place. Incorrect parameterization in the CoE Wire breakage in the clock lines
CLOCK	No function	

### 4.4.3 EP5101-x002 - Signal connection

Encoder pin assignment, M12, socket, 8-pin

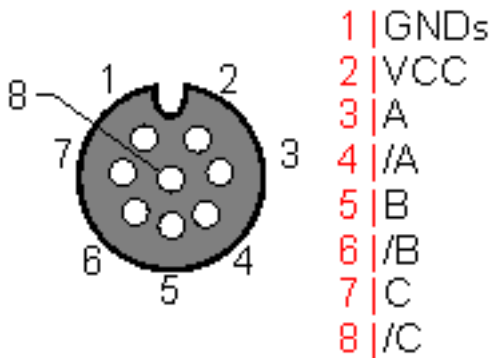

#### LED indicators - meanings

Connection	LED	Display	Meaning
M12	A	off	Input A / track A low
		green	Input A / track A high
	B	off	Input B / track B low
		green	Input B / track B high
	C	off	Input C / track C low
		green	Input C / track C high

### 4.4.4 EP5101-x011 - Signal connection

Encoder pin assignment, D-sub socket, 15-pin

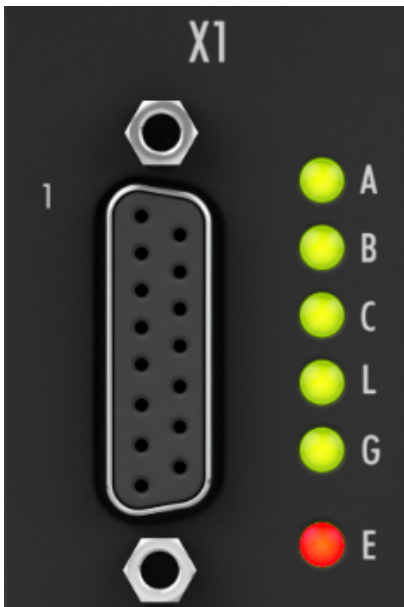
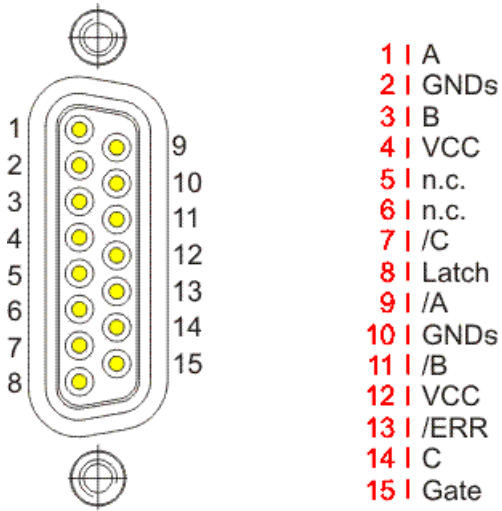

#### LED indicators - meanings

Connection	LED	Display	Meaning
D sub	A	off	Input A / track A low
		green	Input A / track A high
	B	off	Input B / track B low
		green	Input B / track B high
	C	off	Input C / track C low
		green	Input C / track C high
	L	off	Input Latch low
		green	Input Latch high
	G	off	Input Gate low
		green	Input Gate high
	E	off	Input Error low
		red	Input Error high



### 4.4.5 EP5151-0002 - Signal connection

Encoder connection, M12 socket, 8-pin

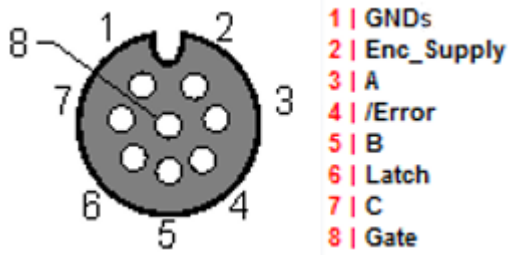

LED indicators - meanings



Connection	LED	Display	Meaning
M12	A	off	Input A / track A low
		green	Input A / track A high
	B	off	Input B / track B low
		green	Input B / track B high
	C	off	Input C / track C low
		green	Input C / track C high
	L	off	Input Latch low
		green	Input Latch high
	G	off	Input Gate low
		green	Input Gate high
	E	off	Input Error low
		red	Input Error high

## 4.5 UL Requirements

The installation of the EtherCAT Box Modules certified by UL has to meet the following requirements.

### Supply voltage

#### ⚠ CAUTION

##### CAUTION!

This UL requirements are valid for all supply voltages of all marked EtherCAT Box Modules!  
For the compliance of the UL requirements the EtherCAT Box Modules should only be supplied

- by a 24 V<sub>DC</sub> supply voltage, supplied by an isolating source and protected by means of a fuse (in accordance with UL248), rated maximum 4 Amp, or
- by a 24 V<sub>DC</sub> power source, that has to satisfy *NEC class 2*.  
A *NEC class 2* power supply shall not be connected in series or parallel with another (class 2) power source!

#### ⚠ CAUTION

##### CAUTION!

To meet the UL requirements, the EtherCAT Box Modules must not be connected to unlimited power sources!

### Networks

#### ⚠ CAUTION

##### CAUTION!

To meet the UL requirements, EtherCAT Box Modules must not be connected to telecommunication networks!

### Ambient temperature range

#### ⚠ CAUTION

##### CAUTION!

To meet the UL requirements, EtherCAT Box Modules has to be operated only at an ambient temperature range of -25 °C to +55 °C!

### Marking for UL

All EtherCAT Box Modules certified by UL (Underwriters Laboratories) are marked with the following label.



Fig. 6: UL label

## 4.6 ATEX notes

### 4.6.1 ATEX - Special conditions

#### WARNING

Observe the special conditions for the intended use of EtherCAT Box modules in potentially explosive areas – directive 94/9/EU.

- The certified components are to be installed with a BG2000-0000 or BG2000-0010 protection enclosure [► 44] that guarantees a protection against mechanical hazards!
- If the temperatures during rated operation are higher than 70°C at the feed-in points of cables, lines or pipes, or higher than 80°C at the wire branching points, then cables must be selected whose temperature data correspond to the actual measured temperature values!
- Observe the permissible ambient temperature range of 0 to 55°C for the use of EtherCAT Box modules in potentially explosive areas!
- Measures must be taken to protect against the rated operating voltage being exceeded by more than 40% due to short-term interference voltages!
- The connections of the certified components may only be connected or disconnected if the supply voltage has been switched off or if a non-explosive atmosphere is ensured!

#### Standards

The fundamental health and safety requirements are fulfilled by compliance with the following standards:

- EN 60079-0: 2006
- EN 60079-15: 2005

#### Marking

The EtherCAT Box modules certified for potentially explosive areas bear the following marking:



II 3 G Ex nA II T4 DEKRA 11ATEX0080 X Ta: 0 - 55°C

or



II 3 G Ex nA nC IIC T4 DEKRA 11ATEX0080 X Ta: 0 - 55°C

#### Batch number (D number)

The EtherCAT Box modules bear a batch number (D number) that is structured as follows:

D: WW YY FF HH

WW - week of production (calendar week)

YY - year of production

FF - firmware version

HH - hardware version

Example with batch number 29 10 02 01:

29 - week of production 29

10 - year of production 2010

02 - firmware version 02

01 - hardware version 01

## 4.6.2 BG2000 - EtherCAT Box protection enclosures

### ⚠ WARNING

#### Risk of electric shock and damage of device!

Bring the EtherCAT system into a safe, powered down state before starting installation, disassembly or wiring of the modules!

### ATEX

### ⚠ WARNING

#### Mount a protection enclosure!

To fulfill the special conditions according to ATEX [▶ 43], a BG2000-0000 or BG2000-0010 protection enclosure has to be mounted over the EtherCAT Box.

### Installation

Put the cables for EtherCAT, power supply and sensors/actuators through the hole of the protection enclosure.

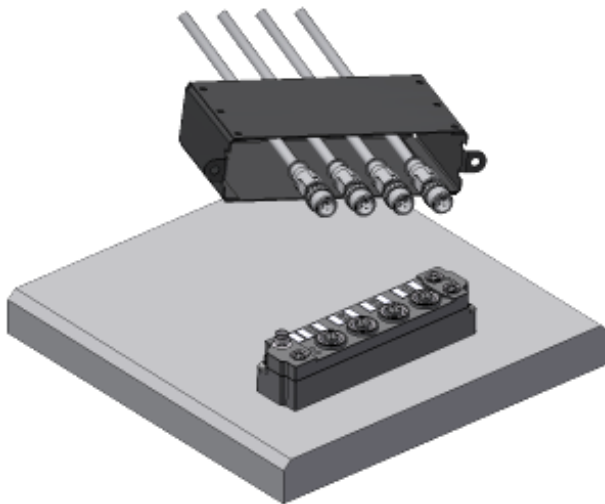

Fig. 7: BG2000 - putting the cables

Fix the wires for EtherCAT, power supply and sensors/actuators to the EtherCAT Box.

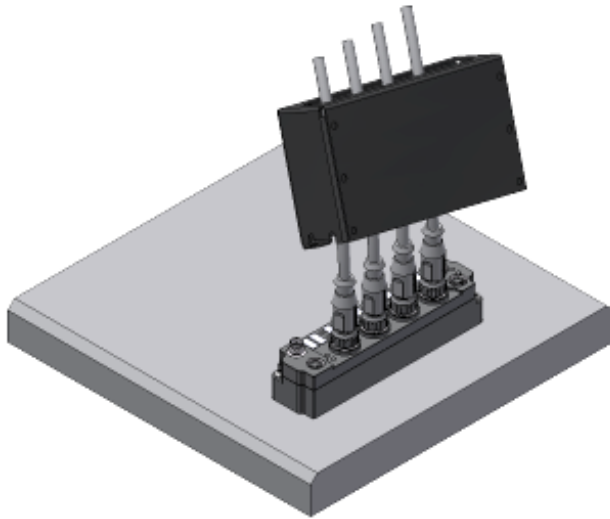

Fig. 8: BG2000 - fixing the cables

Mount the protection enclosure over the EtherCAT Box.

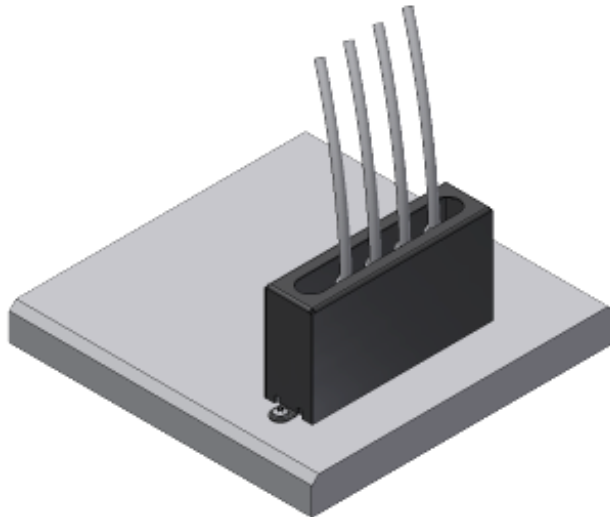

Fig. 9: BG2000 - mounting the protection enclosure

### 4.6.3 ATEX Documentation



#### **Notes about operation of EtherCAT Box Modules (EPxxxx-xxxx) in potentially explosive areas (ATEX)**

Pay also attention to the continuative documentation Notes about operation of EtherCAT Box Modules (EPxxxx-xxxx) in potentially explosive areas (ATEX) that is available in the download area of the Beckhoff homepage <http://www.beckhoff.com>!

## 4.7 Disposal



Products marked with a crossed-out wheeled bin shall not be discarded with the normal waste stream. The device is considered as waste electrical and electronic equipment. The national regulations for the disposal of waste electrical and electronic equipment must be observed.

## **5 Commissioning/Configuration**

### **5.1 Integrating into a TwinCAT project**

The procedure for integration in a TwinCAT project is described in this [Quick start guide](#).

## 5.2 EP5001-0002 - Parameters and modes

### 5.2.1 Basic principles of SSI communication

#### SSI principles

SSI communication sequence

- The SSI master starts pulsing on the clock line with a fixed cycle into the shift register of the SSI slave.
- The slave generally "pushes back" data with a width of 25 bits on the data line. An SSI encoder should determine its position with the first falling edge of the signal at the *Clock* input ("latching"), which is then transferred.
- Once the specified number of bits was pushed, the clock signal is terminated.
- After a pause, polling by the SSI master recommences.

The last data bit can be a PowerFail bit, i.e. the slave signals a power failure. This output depends on the slave.

The number of bit changes equals the clock frequency, i.e. the maximum data transfer rate for a 1 MHz cycle is 1 Mbit/s.

Different SSI slaves have different communication parameters. The communication parameters of the slave must be set in the SSI master:

- Baud rate (e.g., 500 kBaud)
- Coding (e.g., Gray code)
- Data frame type, e.g., multi-turn 25 bits
- Data frame size, e.g., 25 bits
- Data length, i.e. how many bits in the data frame represent the actual position data, e.g., 24 bits.

The communication parameters can be found in the data sheet of the SSI slave.

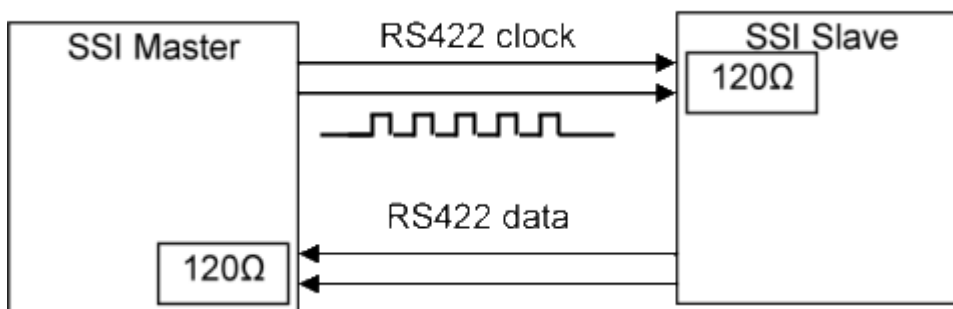

#### Referencing an SSI signal

An SSI encoder is an absolute encoder, i.e. the position value is available without referencing immediately after switch-on.

Many SSI encoders offer the option of referencing or zeroing the position value via an additional digital input. This can be set via the digital output "Set" [► 38]: CoE parameter 800D:03 [► 82].



### 5.2.2 Process data

The EP5001-0002 can have 16 bit status data and a 32-bit counter value.

The screenshot shows the configuration interface for the EP5001-0002 device. On the left, a tree view shows the device structure with 'Status' expanded to show 'Data error', 'Frame error', 'Power failure', 'Sync error', 'TxPDO State', 'TxPDO Toggle', and 'Counter value'. The main window is titled 'Process Data' and contains several sections:

- Sync Manager:** A table showing Sync Manager (SM) details.
 

SM	Size	Type	Flags
0	246	MbxOut	
1	246	MbxIn	
2	0	Outputs	
3	6	Inputs	
- PDO List:** A table showing the PDO configuration.
 

Index	Size	Name	Flags
0x1A00	6.0	SSI Inputs	F
- PDO Assignment (0x1C13):** A list showing the selected PDO assignment: 0x1A00.
- PDO Content (0x1A00):** A table showing the bit-level configuration of the PDO.
 

Index	Size	Offs	Name	Type
0x6000:01	0.1	0.0	Status__Data error	BOOL
0x6000:02	0.1	0.1	Status__Frame error	BOOL
0x6000:03	0.1	0.2	Status__Power failure	BOOL
---	1.2	0.3	---	
0x6000:0E	0.1	1.5	Status__Sync error	BOOL
0x6000:0F	0.1	1.6	Status__TxPDO State	BOOL
0x6000:10	0.1	1.7	Status__TxPDO Toggle	BOOL
0x6000:11	4.0	2.0	Counter value	UDINT
6.0				
- Download:** Checkboxes for 'PDO Assignment' (checked) and 'PDO Configuration' (unchecked).
- Predefined PDO Assignment:** A dropdown menu set to 'Standard (MDP 501)'.
- Buttons:** 'Load PDO info from device' and 'Sync Unit Assignment...'.

Fig. 10: EP5001-0002

### 5.2.2.1 EP5001-0002 - PDO assignment

Sync Manager:

SM	Size	Type	Flags
0	246	MbxOut	
1	246	MbxIn	
2	0	Outputs	
3	6	Inputs	

PDO List:

Index	Size	Name	Flags
0x1A00	6.0	SSI Inputs	F

PDO Assignment (0x1C13):

<input checked="" type="checkbox"/> 0x1A00
--

PDO Content (0x1A00):

Index	Size	Offs	Name	Type
0x6000:01	0.1	0.0	Status__Data error	BOOL
0x6000:02	0.1	0.1	Status__Frame error	BOOL
0x6000:03	0.1	0.2	Status__Power failure	BOOL
--	1.2	0.3	--	
0x6000:0E	0.1	1.5	Status__Sync error	BOOL
0x6000:0F	0.1	1.6	Status__TxPDO State	BOOL
0x6000:10	0.1	1.7	Status__TxPDO Toggle	BOOL
0x6000:11	4.0	2.0	Counter value	UDINT
		6.0		

Download

PDO Assignment

PDO Configuration

Predefined PDO Assignment: 'Standard (MDP 501)'

Load PDO info from device

Sync Unit Assignment...

Fig. 11: PDO assignment and content; example: EP5001-0002

The PDO 0x1A00 configuration of the EP5001-0002 cannot be changed.

#### PDO Assignment

SM3, PDO Assignment 0x1C13				
Index	Index of excluded PDOs	Size (byte.bit)	Name	PDO Content (index - name)
0x1A00 (default)		6.0	SSI Inputs	0x6000:01 [▶ 81] - Data error 0x6000:02 [▶ 81] - Frame error 0x6000:03 [▶ 81] - Power failure 0x6000:0E [▶ 81] - Sync error 0x6000:0F [▶ 81] - TxPDO State 0x6000:10 [▶ 81] - TxPDO Toggle 0x6000:11 [▶ 81] - Counter value (32-Bit)

### 5.2.3 DC (Distributed Clocks)

Describes whether the module is operated with support from distributed clocks:

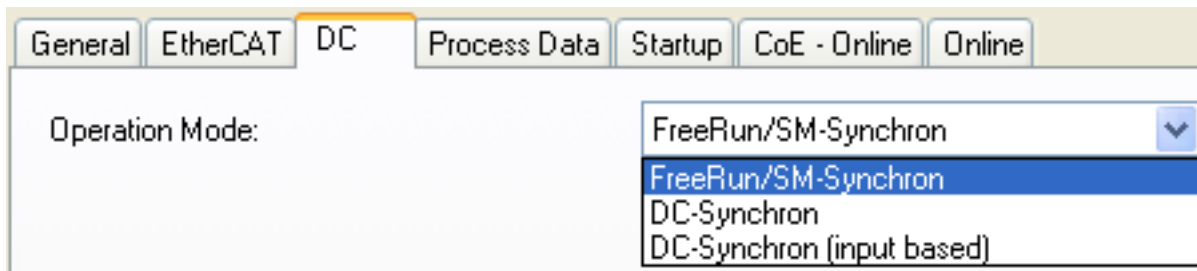

Fig. 12: Distributed Clocks

- **FreeRun:** The module operates frame-triggered. Cyclic operation is started via the SyncManagers during EtherCAT frame processing.
- **DC-Synchron:** Cyclic operation in the module is started by the local distributed clock at exact intervals. The start time is chosen such that it coincides with other output slaves in the EtherCAT system.
- **DC-Synchron (input based):** as DC-Synchron mode, with the cyclic start time chosen such that it coincides with other input slaves in the EtherCAT system.

## 5.2.4 Features CoE

Further settings can be selected in the CoE (CAN over EtherCAT)-list.

### ● Parameterization via the CoE list (CAN over EtherCAT)

**I** Please note the following general CoE notes when using/manipulating the CoE parameters:

- Keep a startup list if components have to be replaced
- Differentiation between online/offline dictionary, existence of current XML description
- “CoE-Reload” for resetting the changes

The following CoE settings from objects 0x8000 and 0x800D are possible and are shown below in their default settings:

The parameters are described in the object description chapter.

### SSI settings

- **Index 0x8000:01 [▶ 81], disable frame error**  
If the bit is set to TRUE, data errors such as invalid telegram size are no longer shown in the *Data error* process data.
- **Index 0x8000:02 [▶ 81], enable power failure bit**  
If the bit is set to TRUE, the last bit (LSB) in the SSI telegram is interpreted as PowerFail bit of the SSI slave and shown in the process data.
- **Index 0x8000:03 [▶ 81], enable inhibit time**  
If the bit is set to TRUE, the system waits at least until the *Min. Inhibit time* (index 0x8000 [▶ 81]:13) has elapsed when the next SSI communication starts, even if the next start request has already been issued via EtherCAT or distributed clocks.
- **Index 0x8000:04 [▶ 81], enable test mode**  
Only for production purposes.
- **Index 0x8000:06 [▶ 81], SSI-encoding**  
Dual or gray coding setting (standard).
- **Index 0x8000:09 [▶ 81], SSI baud rate**  
should be set to 125, 250, 500 kbaud (default) or 1 Mbaud.
- **Index 0x8000:0F [▶ 81], SSI-frame type**  
25, 13 or variable bit width (default: 25).
- **Index 0x8000:11 [▶ 81], SSI-frame size**  
Total data volume including PowerFail bit.
- **Index 0x8000:12 [▶ 81], SSI-data length**  
Data volume without PowerFail bit.
- **Index 0x8000:13 [▶ 81], Min. inhibit time [μs]**  
See index 0x8000:03 [▶ 81].

### SSI advanced settings

- **Index 0x800D:01 [▶ 82], Encoder power supply on**  
Switches the 24 V supply voltage
- **Index 0x800D:02 [▶ 82], Encoder direction pin on**  
Switches the 24 V supply at the *Direction pin*
- **Index 0x800D:03 [▶ 82], Encoder reset pin on**  
Switches the 24 V supply at the *Reset pin*

The total size of the data depends on the encoder used. It is also type-specific whether a power-fail bit or another auxiliary bit is supported. The counter value in the *Counter Value* index 0x6000:11 [▶ 81] is determined based on the value entered in object *SSI data length* index 0x8000:12 [▶ 81]. A few example configurations are shown below:

Specification of the encoder			Settings in the CoE of the box			
ST	MT	Error bit	0x8000:0F SSI frame type	0x8000:11 SSI frame size	0x8000:12 SSI data length	0x8000:02 Enable power failure bit
13	0	0	1: Single-turn analysis is active	13	13	0: Power failure bit is not active
12	12	1	0: Multi-turn analysis is active	25	24	1: Power failure bit is active
12	12	0	2: Variable analysis is active	24	24	0: Power failure bit is not active
12	13	0	2: Variable analysis is active	25	25	0: Power failure bit is not active
16	16	0	2: Variable analysis is active	32	32	0: Power failure bit is not active
16	0	0	2: Variable analysis is active	16	16	0: Power failure bit is not active
13	16	1	2: Variable analysis is active	30	29	1: Power failure bit is active
12	12	2	2: Variable analysis is active	26*	26*	0: Power failure bit is not active

\*) Analysis of the data and division into position and auxiliary bits must take place in the PLC.

If the encoder offers more than 1 auxiliary bit, this can be done by means of suitable configuration of the objects *0x8000:11 SSI frame size* and *0x80n0 SSI data length*. The maximum size of 32 bits must be considered here. If the parameters have the same size, the *Counter Value* index *0x6000:11* [▶ 81] does not only show the position, but also additional bits. Analysis of the data and division into position and auxiliary bits must take place in the PLC.

If the settings are not made correctly in the CoE, or if there is an error at the inputs, this is indicated via the status bits

Data error (Index <i>0x6000:01</i> [▶ 81])	Frame error (Index <i>0x6000:02</i> [▶ 81])	Possible error type
TRUE	FALSE	SSI input error: - SSI without power supply - Wire breakage on one of the SSI lines If no data transmission occurs, the SSI input is on low signal level.
FALSE	TRUE	There is an incorrect data frame, the data frame was not concluded with zero, or possibly - Wire breakage in the clock lines - Incorrect parameterization in the CoE
TRUE	TRUE	- Broken wire at SSI data inputs D+ or D- - Data cables interchanged
FALSE	FALSE	If bits are shifted in the counter value despite correct CoE parameterization, this may be to do with the clock lines being swapped

## 5.3 EP51x1-x0xx - Parameters and modes

### 5.3.1 Basic function principles

The box acquires the 90° phase-shifted digital output signal of an incremental encoder on channels A and B. The zero pulse is acquired on channel C. These signals are converted into a position value with quadruple evaluation with the aid of the quadrature encoder and the 32-bit counter. The latch and reset functions enable the exact referencing and saving of the counter value, irrespective of the speed.

Incremental encoders divide a 360° rotation of the encoder axis into individual steps (increments) and mark a full revolution by means of a special mark (zero pulse).

The phase angle between the signals on channels A and B sets the counting direction.

Up: signal on channel A leads signal on channel B by 90°

Down: signal on channel A lags signal on channel B by 90°

In case of single evaluation, the positive edges on channel A are counted.

In case of quadruple evaluation, the positive and negative edges on channel A and channel B are counted.

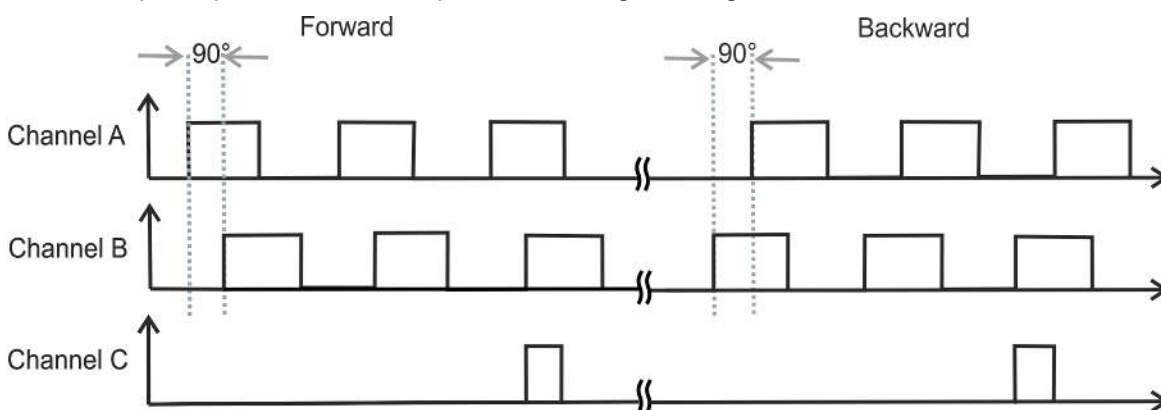

Fig. 13: Quadrature decoder

Whereas absolute value encoders deliver an absolute and unambiguous position value over the complete travel path directly after switching on, it is necessary with incremental encoders to perform a reference run (homing) after switching on in order to be able to determine an unambiguous position.

Referencing can be carried out, for example, with the aid of reference cams or using the zero pulse of the encoder.

### 5.3.2 Process data

#### 16 or 32 bit process data

The Box can be operated with 16 bit process data (default) or 32 bit process data. This can be set via the *Predefined PDO Assignment* in the *Process Data* table tab.

The screenshot shows the configuration software interface for a device. On the left is a tree view showing the configuration hierarchy: SYSTEM - Configuration, NC - Configuration, PLC - Configuration, I/O - Configuration, and I/O Devices. Under I/O Devices, there is 'Device 1 (EtherCAT)' and 'Box 1 (EP5101-0002)'. The 'Process Data' tab is selected, showing the following components:

- Sync Manager:**

SM	Size	Type	Flags
0	128	MbxOut	
1	128	MbxIn	
2	4	Outputs	
3	6	Inputs	
- PDO List:**

Index	Size	Name	Flags	SM	SU
0x1A00	6.0	ENC Status compact	F	3	0
0x1A01	10.0	ENC Status	F	0	0
0x1A02	4.0	ENC Frequency	F	0	0
0x1A03	4.0	ENC Period	F	0	0
0x1A04	8.0	ENC Timest.	F	0	0
0x1A05	4.0	ENC Timest. compact	F	0	0
0x1600	4.0	ENC Control compact	F	2	0
0x1601	6.0	ENC Control	F	0	0
- PDO Assignment (0x1C12):**
  - 0x1600
  - 0x1601 (excluded by 0x1600)
- PDO Content (0x1A00):**

Index	Size	Offs	Name	Type
0x6000:01	0.1	0.0	Status__Latch C valid	BOOL
---	0.1	0.1	---	---
0x6000:03	0.1	0.2	Status__Set counter done	BOOL
0x6000:04	0.1	0.3	Status__Counter underflow	BOOL
0x6000:05	0.1	0.4	Status__Counter overflow	BOOL
---	0.1	0.5	---	---
0x6000:07	0.1	0.6	Status__Open circuit	BOOL
- Predefined PDO Assignment:**
  - Standard 16 Bit (MDP 511) (selected)
  - Predefined PDO Assignment: (none)
  - Predefined PDO Assignment: 'Standard 16 Bit (MDP 511)'
  - Predefined PDO Assignment: 'Standard 32 Bit (MDP 511)'
  - Predefined PDO Assignment: 'Line Motion (MDP 511)'
  - Predefined PDO Assignment: 'Line Motion DC (MDP 511)'

Fig. 14: 16 or 32 bit process data

## Main PDO

Selection of basic process data

The screenshot displays the configuration interface for the Main PDO. It is divided into four main sections:

- Sync Manager:** A table with columns SM, Size, Type, and Flags. Row 3 (SM 3, Size 10, Type Inputs) is highlighted with a red box labeled 'A'.
- PDO List:** A table with columns Index, Size, and Name. Rows 0x1A00 to 0x1A05 and 0x1600 to 0x1601 are listed. The first three rows (0x1A00, 0x1A01, 0x1A02) are highlighted with a red box labeled 'C'.
- PDO Assignment (0x1C13):** A list of checkboxes for PDOs 0x1A00 to 0x1A05. 0x1A00 and 0x1A02 are checked, highlighted with a red box labeled 'B'.
- PDO Content (0x1A01):** A table with columns Index, Size, Offs, and Name. It shows the content for PDO 0x1A01, with the first six rows highlighted by a red box labeled 'D'.

Fig. 15: Main PDO example

A: Selection of data direction: input or output  
 B: Selection of (optional) PDOs (process data objects)

C: Explanatory notes for PDOs  
 D: PDO content

- **compact:** The process data can be represented with 16 bits (*compact*) or with 32 bits.

## Optional PDOs

Optional PDOs, in addition to the main PDO:

- PDO 1 (0x1A02 or 0x1A03): The **frequency** or the **period** can be selected as optional PDO 1.
- PDO 2 (0x1A04 or 0x1A05): In one of the DC modes a 32 bit or 64 bit **timestamp** can be selected. The timestamp specifies the time of the last registered increment edge, based on the Distributed Clocks system.

### ● PDO assignment and contents

**i** The PDO assignment and contents may differ for different Boxes. For PDO content and assignment please refer to the

- Process Data tab of the TwinCAT System Manager or the
- PDOs assignment chapter for the respective Box.



### 5.3.2.1 EP5101-x002 - PDO assignment

The screenshot shows the configuration interface for PDO assignment. At the top, there are tabs for 'General', 'EtherCAT', 'DC', 'Process Data', 'Startup', 'CoE - Online', and 'Online'. The 'Process Data' tab is active.

**Sync Manager:**

SM	Size	Type	Flags
0	128	MbxOut	
1	128	MbxIn	
2	4	Outputs	
3	6	Inputs	

**PDO List:**

Index	Size	Name	Flags	SM	SU
0x1A00	6.0	ENC Status compact	F	3	0
0x1A01	10.0	ENC Status	F		0
0x1A02	4.0	ENC Frequency	F		0
0x1A03	4.0	ENC Period	F		0
0x1A04	8.0	ENC Timest.	F		0
0x1A05	4.0	ENC Timest. compact	F		0
0x1600	4.0	ENC Control compact	F	2	0
0x1601	6.0	ENC Control	F		0

**PDO Assignment (0x1C13):**

- 0x1A00
- 0x1A01 (excluded by 0x1A00)
- 0x1A02
- 0x1A03
- 0x1A04
- 0x1A05

**PDO Content (0x1A00):**

Index	Size	Offs	Name	Type	Default (hex)
0x6000:01	0.1	0.0	Status__Latch C valid	BOOL	
--	0.1	0.1	--		
0x6000:03	0.1	0.2	Status__Set counter done	BOOL	
0x6000:04	0.1	0.3	Status__Counter underflow	BOOL	
0x6000:05	0.1	0.4	Status__Counter overflow	BOOL	
--	0.1	0.5	--		
0x6000:07	0.1	0.6	Status__Open circuit	BOOL	
0x6000:08	0.1	0.7	Status__Extrapolation stall	BOOL	
0x6000:09	0.1	1.0	Status__Status of input A	BOOL	
0x6000:0A	0.1	1.1	Status__Status of input B	BOOL	
0x6000:0B	0.1	1.2	Status__Status of input C	BOOL	
--	0.2	1.3	--		
0x1C32:20	0.1	1.5	Status__Sync error	BOOL	
0x1800:07	0.1	1.6	Status__TxPDO State	BOOL	
0x1800:09	0.1	1.7	Status__TxPDO Toggle	BOOL	
0x6000:11	2.0	2.0	Counter value	UINT	
0x6000:12	2.0	4.0	Latch value	UINT	
		6.0			

**Download:**

- PDO Assignment
- PDO Configuration

**Predefined PDO Assignment:** 'Standard 16 Bit (MDP 511)'

**Buttons:** Load PDO info from device, Sync Unit Assignment...

#### PDO Assignment

To configure the process data, select the required Sync Manager (SM 2 or SM 3 can be changed) in the *Sync Manager* field at the top left (see illustration above). The process data assigned to this Sync Manager can then be switched on or off in the *PDO Assignment* field below. Restarting the EtherCAT system, or reloading the configuration in Config mode (F4), causes the EtherCAT communication to restart, and the process data is transferred from the box.

SM2, PDO Assignment 0x1C12				
Index	Index of excluded PDOs	Size (byte.bit)	Name	PDO Content (index - name)
0x1600 (default)	0x1601	4.0	ENC Control compact	0x7000:01 [▶ 86] - Enable Latch C 0x7000:03 [▶ 86] - Set counter 0x7000:11 [▶ 86] - Set counter value (16-bit)
0x1601	0x1600	6.0	ENC Control	0x7000:01 [▶ 86] - Enable Latch C 0x7000:03 [▶ 86] - Set counter 0x7000:11 [▶ 86] - Set counter value (32-bit)

SM3, PDO Assignment 0x1C13				
Index	Index of excluded PDOs	Size (byte.bit)	Name	PDO Content (index - name)
0x1A00 (default)	0x1A01	6.0	ENC Status compact	0x6000:01 [▶ 85] - Latch C valid 0x6000:03 [▶ 85] - Set counter done 0x6000:04 [▶ 85] - Counter underflow 0x6000:05 [▶ 85] - Counter overflow 0x6000:07 [▶ 85] - Open circuit 0x6000:08 [▶ 85] - Extrapolation stall 0x6000:09 [▶ 85] - Status of input A 0x6000:0A [▶ 85] - Status of input B 0x6000:0B [▶ 85] - Status of input C 0x1C32:20 [▶ 94] - Sync error 0x1800:07 [▶ 88] - TxPDO State 0x1800:09 [▶ 88] - TxPDO Toggle 0x6000:11 [▶ 85] - Counter value (16-Bit) 0x6000:12 [▶ 85] - Latch value (16-Bit)
0x1A01	0x1A00	10.0	ENC Status	0x6000:01 [▶ 85] - Latch C valid 0x6000:03 [▶ 85] - Set counter done 0x6000:04 [▶ 85] - Counter underflow 0x6000:05 [▶ 85] - Counter overflow 0x6000:07 [▶ 85] - Open circuit 0x6000:08 [▶ 85] - Extrapolation stall 0x6000:09 [▶ 85] - Status of input A 0x6000:0A [▶ 85] - Status of input B 0x6000:0B [▶ 85] - Status of input C 0x1C32:20 [▶ 94] - Sync error 0x1800:07 [▶ 88] - TxPDO State 0x1800:09 [▶ 88] - TxPDO Toggle 0x6000:11 [▶ 85] - Counter value (32-Bit) 0x6000:12 [▶ 85] - Latch value (32-Bit)
0x1A02	0x1A03	4.0	ENC Frequency	0x6000:13 [▶ 85] - Frequency value
0x1A03	0x1A02	4.0	ENC Period	0x6000:14 [▶ 85] - Period value
0x1A04	0x1A05	8.0	ENC Timest.	0x6000:16 [▶ 85] - timestamp (64-bit)
0x1A05	0x1A04	4.0	ENC Timest. compact	0x6000:16 [▶ 85] - timestamp compact (32-bit)

## PDO Assignment

To configure the process data, select the required Sync Manager (SM 2 or SM 3 can be changed) in the *Sync Manager* field at the top left (see illustration above). The process data assigned to this Sync Manager can then be switched on or off in the *PDO Assignment* field below. Restarting the EtherCAT system, or reloading the configuration in Config mode (F4), causes the EtherCAT communication to restart, and the process data is transferred from the box.

SM2, PDO Assignment 0x1C12				
Index	Index of excluded PDOs	Size (byte.bit)	Name	PDO Content (index - name)
0x1600 (default)	0x1601	4.0	ENC Control compact	0x7000:01 [▶ 114] - Enable Latch C 0x7000:02 [▶ 114] - Enable Latch extern on positive edge 0x7000:03 [▶ 114] - Set counter 0x7000:04 [▶ 114] - Enable Latch extern on negative edge 0x7000:11 [▶ 114] - Set counter value (16-bit)
0x1601	0x1600	6.0	ENC Control	0x7000:01 [▶ 114] - Enable Latch C 0x7000:02 [▶ 114] - Enable Latch extern on positive edge 0x7000:03 [▶ 114] - Set counter 0x7000:04 [▶ 114] - Enable Latch extern on negative edge 0x7000:11 [▶ 114] - Set counter value (32-bit)

SM3, PDO Assignment 0x1C13				
Index	Index of excluded PDOs	Size (byte.bit)	Name	PDO Content (index - name)
0x1A00 (default)	0x1A01	6.0	ENC Status compact	0x6000:01 [▶ 113] - Latch C valid 0x6000:02 [▶ 113] - Latch extern valid 0x6000:03 [▶ 113] - Set counter done 0x6000:04 [▶ 113] - Counter underflow 0x6000:05 [▶ 113] - Counter overflow 0x6000:06 [▶ 113] - Status of input status 0x6000:07 [▶ 113] - Open circuit 0x6000:08 [▶ 113] - Extrapolation stall 0x6000:09 [▶ 113] - Status of input A 0x6000:0A [▶ 113] - Status of input B 0x6000:0B [▶ 113] - Status of input C 0x6000:0C [▶ 113] - Status of input gate 0x6000:0D [▶ 113] - Status of extern latch 0x1C32:20 [▶ 120] - Sync error 0x1800:07 [▶ 116] - TxPDO State 0x1800:09 [▶ 116] - TxPDO Toggle 0x6000:11 [▶ 113] - Counter value (16-Bit) 0x6000:12 [▶ 113] - Latch value (16-Bit)
0x1A01	0x1A00	10.0	ENC Status	0x6000:01 [▶ 113] - Latch C valid 0x6000:02 [▶ 113] - Latch extern valid 0x6000:03 [▶ 113] - Set counter done 0x6000:04 [▶ 113] - Counter underflow 0x6000:05 [▶ 113] - Counter overflow 0x6000:06 [▶ 113] - Status of input status 0x6000:07 [▶ 113] - Open circuit 0x6000:08 [▶ 113] - Extrapolation stall 0x6000:09 [▶ 113] - Status of input A 0x6000:0A [▶ 113] - Status of input B 0x6000:0B [▶ 113] - Status of input C 0x6000:0C [▶ 113] - Status of input gate 0x6000:0D [▶ 113] - Status of extern latch 0x1C32:20 [▶ 120] - Sync error 0x1800:07 [▶ 116] - TxPDO State 0x1800:09 [▶ 116] - TxPDO Toggle 0x6000:11 [▶ 113] - Counter value (32-Bit) 0x6000:12 [▶ 113] - Latch value (32-Bit)
0x1A02	0x1A03	4.0	ENC Frequency	0x6000:13 [▶ 113] - Frequency value
0x1A03	0x1A02	4.0	ENC Period	0x6000:14 [▶ 113] - Period value
0x1A04	0x1A05	8.0	ENC Timest.	0x6000:16 [▶ 113] - timestamp (64-bit)
0x1A05	0x1A04	4.0	ENC Timest. compact	0x6000:16 [▶ 113] - timestamp compact (32-bit)

### 5.3.2.2 EP5101-0011 - PDO assignment

General | EtherCAT | DC | Process Data | Startup | CoE - Online | Online

Sync Manager:      PDO List:

SM	Size	Type	Flags
0	128	MbxOut	
1	128	MbxIn	
2	4	Outputs	
3	6	Inputs	

Index	Size	Name	Flags	SM	SU
0x1A00	6.0	ENC Status compact	F	3	0
0x1A01	10.0	ENC Status	F		0
0x1A02	4.0	ENC Frequency	F		0
0x1A03	4.0	ENC Period	F		0
0x1A04	8.0	ENC Timest.	F		0
0x1A05	4.0	ENC Timest. compact	F		0
0x1600	4.0	ENC Control compact	F	2	0
0x1601	6.0	ENC Control	F		0

PDO Assignment (0x1C13):

- 0x1A00
- 0x1A01 (excluded by 0x1A00)
- 0x1A02
- 0x1A03
- 0x1A04
- 0x1A05

PDO Content (0x1A00):

Index	Size	Offs	Name	Type	Default (hex)
0x6000:01	0.1	0.0	Status__Latch C valid	BOOL	
0x6000:02	0.1	0.1	Status__Latch extem valid	BOOL	
0x6000:03	0.1	0.2	Status__Set counter done	BOOL	
0x6000:04	0.1	0.3	Status__Counter underflow	BOOL	
0x6000:05	0.1	0.4	Status__Counter overflow	BOOL	
0x6000:06	0.1	0.5	Status__Status of input status	BOOL	
0x6000:07	0.1	0.6	Status__Open circuit	BOOL	
0x6000:08	0.1	0.7	Status__Extrapolation stall	BOOL	
0x6000:09	0.1	1.0	Status__Status of input A	BOOL	
0x6000:0A	0.1	1.1	Status__Status of input B	BOOL	
0x6000:0B	0.1	1.2	Status__Status of input C	BOOL	
0x6000:0C	0.1	1.3	Status__Status of input gate	BOOL	
0x6000:0D	0.1	1.4	Status__Status of extem latch	BOOL	
0x1C32:20	0.1	1.5	Status__Sync error	BOOL	
0x1800:07	0.1	1.6	Status__TxPDO State	BOOL	
0x1800:09	0.1	1.7	Status__TxPDO Toggle	BOOL	
0x6000:11	2.0	2.0	Counter value	UINT	
0x6000:12	2.0	4.0	Latch value	UINT	
		6.0			

Download

- PDO Assignment
- PDO Configuration

Predefined PDO Assignment: 'Standard 16 Bit (MDP 511)'

Load PDO info from device

Sync Unit Assignment...

#### PDO Assignment

To configure the process data, select the required Sync Manager (SM 2 or SM 3 can be changed) in the *Sync Manager* field at the top left (see illustration above). The process data assigned to this Sync Manager can then be switched on or off in the *PDO Assignment* field below. Restarting the EtherCAT system, or reloading the configuration in Config mode (F4), causes the EtherCAT communication to restart, and the process data is transferred from the box.

SM2, PDO Assignment 0x1C12				
Index	Index of excluded PDOs	Size (byte.bit)	Name	PDO Content (index - name)
0x1600 (default)	0x1601	4.0	ENC Control compact	0x7000:01 [▶ 101] - Enable Latch C 0x7000:02 [▶ 101] - Enable Latch extern on positive edge 0x7000:03 [▶ 101] - Set counter 0x7000:04 [▶ 101] - Enable Latch extern on negative edge 0x7000:11 [▶ 101] - Set counter value (16-bit)
0x1601	0x1600	6.0	ENC Control	0x7000:01 [▶ 101] - Enable Latch C 0x7000:02 [▶ 101] - Enable Latch extern on positive edge 0x7000:03 [▶ 101] - Set counter 0x7000:04 [▶ 101] - Enable Latch extern on negative edge 0x7000:11 [▶ 101] - Set counter value (32-bit)

SM3, PDO Assignment 0x1C13				
Index	Index of excluded PDOs	Size (byte.bit)	Name	PDO Content
0x1A00 (default)	0x1A01	6.0	ENC Status compact	0x6000:01 [▶ 100] - Latch C valid 0x6000:02 [▶ 100] - Latch extern valid 0x6000:03 [▶ 100] - Set counter done 0x6000:04 [▶ 100] - Counter underflow 0x6000:05 [▶ 100] - Counter overflow 0x6000:06 [▶ 100] - Status of input status 0x6000:07 [▶ 100] - Open circuit 0x6000:08 [▶ 100] - Extrapolation stall 0x6000:09 [▶ 100] - Status of input A 0x6000:0A [▶ 100] - Status of input B 0x6000:0B [▶ 100] - Status of input C 0x6000:0C [▶ 100] - Status of input gate 0x6000:0D [▶ 100] - Status of extern latch 0x1C32:20 [▶ 107] - Sync error 0x1800:07 [▶ 103] - TxPDO State 0x1800:09 [▶ 103] - TxPDO Toggle 0x6000:11 [▶ 100] - Counter value (16-Bit) 0x6000:12 [▶ 100] - Latch value (16-Bit)
0x1A01	0x1A00	10.0	ENC Status	0x6000:01 [▶ 100] - Latch C valid 0x6000:02 [▶ 100] - Latch extern valid 0x6000:03 [▶ 100] - Set counter done 0x6000:04 [▶ 100] - Counter underflow 0x6000:05 [▶ 100] - Counter overflow 0x6000:06 [▶ 100] - Status of input status 0x6000:07 [▶ 100] - Open circuit 0x6000:08 [▶ 100] - Extrapolation stall 0x6000:09 [▶ 100] - Status of input A 0x6000:0A [▶ 100] - Status of input B 0x6000:0B [▶ 100] - Status of input C 0x6000:0C [▶ 100] - Status of input gate 0x6000:0D [▶ 100] - Status of extern latch 0x1C32:20 [▶ 107] - Sync error 0x1800:07 [▶ 103] - TxPDO State 0x1800:09 [▶ 103] - TxPDO Toggle 0x6000:11 [▶ 100] - Counter value (32-Bit) 0x6000:12 [▶ 100] - Latch value (32-Bit)
0x1A02	0x1A03	4.0	ENC Frequency	0x6000:13 [▶ 100] - Frequency value
0x1A03	0x1A02	4.0	ENC Period	0x6000:14 [▶ 100] - Period value
0x1A04	0x1A05	8.0	ENC Timest.	0x6000:16 [▶ 100] - timestamp (64-bit)
0x1A05	0x1A04	4.0	ENC Timest. compact	0x6000:16 [▶ 100] - timestamp compact (32-bit)

### 5.3.2.3 EP5101-2011 - PDO assignment

General
EtherCAT
DC
Process Data
Startup
CoE - Online
Online

Sync Manager:

SM	Size	Type	Flags
0	128	MbxOut	
1	128	MbxIn	
2	4	Outputs	
3	6	Inputs	

PDO List:

Index	Size	Name	Flags	SM	SU
0x1A00	10.0	ENC Status	F		0
0x1A01	6.0	ENC Status compact	F	3	0
0x1A02	4.0	ENC Period	F		0
0x1A03	4.0	ENC Frequency	F		0
0x1A04	8.0	ENC Timest.	F		0
0x1A05	4.0	ENC Timest. compact	F		0
0x1600	6.0	ENC Control	F		0
0x1601	4.0	ENC Control compact	F	2	0

PDO Assignment (0x1C13):

- 0x1A00 (excluded by 0x1A01)
- 0x1A01
- 0x1A02
- 0x1A03
- 0x1A04
- 0x1A05

PDO Content (0x1A01):

Index	Size	Offs	Name	Type	Default (hex)
0x6000:01	0.1	0.0	Status__Latch C valid	BOOL	
0x6000:02	0.1	0.1	Status__Latch extem valid	BOOL	
0x6000:03	0.1	0.2	Status__Set counter done	BOOL	
---	0.2	0.3	---		
0x6000:06	0.1	0.5	Status__Status of input status	BOOL	
0x6000:07	0.1	0.6	Status__Open circuit	BOOL	
---	0.1	0.7	---		
0x6000:09	0.1	1.0	Status__Status of input A	BOOL	
0x6000:0A	0.1	1.1	Status__Status of input B	BOOL	
0x6000:0B	0.1	1.2	Status__Status of input C	BOOL	
0x6000:0C	0.1	1.3	Status__Status of input gate	BOOL	
0x6000:0D	0.1	1.4	Status__Status of extem latch	BOOL	
0x6000:0E	0.1	1.5	Status__Sync error	BOOL	
0x6000:0F	0.1	1.6	Status__TxPDO State	BOOL	
0x6000:10	0.1	1.7	Status__TxPDO Toggle	BOOL	
0x6000:11	2.0	2.0	Counter value	UINT	
0x6000:12	2.0	4.0	Latch value	UINT	
		6.0			

Download

 PDO Assignment  
 PDO Configuration

Predefined PDO Assignment: 'Standard 16 Bit (MDP 511)'

Load PDO info from device

Sync Unit Assignment...

Fig. 16: PDO assignment and content, EP5101-2011

#### PDO Assignment

To configure the process data, select the required Sync Manager (SM 2 or SM 3 can be changed) in the *Sync Manager* field at the top left (see illustration above). The process data assigned to this Sync Manager can then be switched on or off in the *PDO Assignment* field below. Restarting the EtherCAT system, or reloading the configuration in Config mode (F4), causes the EtherCAT communication to restart, and the process data is transferred from the box.

SM2, PDO Assignment 0x1C12				
Index	Index of excluded PDOs	Size (byte.bit)	Name	PDO Content (index - name)
0x1600	0x1601	6.0	ENC Control	0x7000:01 - Enable Latch C 0x7000:02 - Enable Latch extern on positive edge 0x7000:03 - Set counter 0x7000:04 - Enable Latch extern on negative edge 0x7000:11 - Set counter value (32-bit)
0x1601 (default)	0x1600	4.0	ENC Control compact	0x7000:01 - Enable Latch C 0x7000:02 - Enable Latch extern on positive edge 0x7000:03 - Set counter 0x7000:04 - Enable Latch extern on negative edge 0x7000:11 - Set counter value (16-bit)

SM3, PDO Assignment 0x1C13				
Index	Index of excluded PDOs	Size (byte.bit)	Name	PDO Content (index - name)
0x1A00	0x1A01	10.0	ENC Status	0x6000:01 - Latch C valid 0x6000:02 - Latch extern valid 0x6000:03 - Set counter done 0x6000:06 - Status of input status 0x6000:07 - Open circuit 0x6000:09 - Status of input A 0x6000:0A - Status of input B 0x6000:0B - Status of input C 0x6000:0C - Status of input gate 0x6000:0D - Status of extern latch 0x6000:0E - Sync error 0x6000:0F - TxPDO State 0x6000:10 - TxPDO Toggle 0x6000:11 - Counter value (32-Bit) 0x6000:12 - Latch value (32-Bit)
0x1A01 (default)	0x1A00	6.0	ENC Status compact	0x6000:01 - Latch C valid 0x6000:02 - Latch extern valid 0x6000:03 - Set counter done 0x6000:06 - Status of input status 0x6000:07 - Open circuit 0x6000:09 - Status of input A 0x6000:0A - Status of input B 0x6000:0B - Status of input C 0x6000:0C - Status of input gate 0x6000:0D - Status of extern latch 0x6000:0E - Sync error 0x6000:0F - TxPDO State 0x6000:10 - TxPDO Toggle 0x6000:11 - Counter value (16-Bit) 0x6000:12 - Latch value (16-Bit)
0x1A02	0x1A03	4.0	ENC Period	0x6000:14 - Period value
0x1A03	0x1A02	4.0	ENC Frequency	0x6000:13 - Frequency value
0x1A04	0x1A05	8.0	ENC Timest.	0x6000:16 - timestamp (64-bit)
0x1A05	0x1A04	4.0	ENC Timest. compact	0x6000:16 - timestamp compact (32-bit)

### 5.3.2.4 EP5151-0002 - PDO assignment

General | EtherCAT | DC | Process Data | Startup | CoE - Online | Online

Sync Manager: PDO List:

SM	Size	Type	Flags
0	128	MbxOut	
1	128	MbxIn	
2	4	Outputs	
3	6	Inputs	

Index	Size	Name	Flags	SM	SU
0x1A00	6.0	ENC Status compact	F	3	0
0x1A01	10.0	ENC Status	F		0
0x1A02	4.0	ENC Frequency	F		0
0x1A03	4.0	ENC Period	F		0
0x1A04	8.0	ENC Timest.	F		0
0x1A05	4.0	ENC Timest. compact	F		0
0x1600	4.0	ENC Control compact	F	2	0
0x1601	6.0	ENC Control	F		0

PDO Assignment (0x1C13):

- 0x1A00
- 0x1A01 (excluded by 0x1A00)
- 0x1A02
- 0x1A03
- 0x1A04
- 0x1A05

PDO Content (0x1A00):

Index	Size	Offs	Name	Type	Default (hex)
0x6000:01	0.1	0.0	Status__Latch C valid	BOOL	
0x6000:02	0.1	0.1	Status__Latch extem valid	BOOL	
0x6000:03	0.1	0.2	Status__Set counter done	BOOL	
0x6000:04	0.1	0.3	Status__Counter underflow	BOOL	
0x6000:05	0.1	0.4	Status__Counter overflow	BOOL	
0x6000:06	0.1	0.5	Status__Status of input status	BOOL	
0x6000:07	0.1	0.6	Status__Open circuit	BOOL	
0x6000:08	0.1	0.7	Status__Extrapolation stall	BOOL	
0x6000:09	0.1	1.0	Status__Status of input A	BOOL	
0x6000:0A	0.1	1.1	Status__Status of input B	BOOL	
0x6000:0B	0.1	1.2	Status__Status of input C	BOOL	
0x6000:0C	0.1	1.3	Status__Status of input gate	BOOL	
0x6000:0D	0.1	1.4	Status__Status of extem latch	BOOL	
0x1C32:20	0.1	1.5	Status__Sync error	BOOL	
0x1800:07	0.1	1.6	Status__TxPDO State	BOOL	
0x1800:09	0.1	1.7	Status__TxPDO Toggle	BOOL	
0x6000:11	2.0	2.0	Counter value	UINT	
0x6000:12	2.0	4.0	Latch value	UINT	
		6.0			

Download

PDO Assignment

PDO Configuration

Predefined PDO Assignment: 'Standard 16 Bit (MDP 511)'

Load PDO info from device

Sync Unit Assignment...

#### PDO Assignment

To configure the process data, select the required Sync Manager (SM 2 or SM 3 can be changed) in the *Sync Manager* field at the top left (see illustration above). The process data assigned to this Sync Manager can then be switched on or off in the *PDO Assignment* field below. Restarting the EtherCAT system, or reloading the configuration in Config mode (F4), causes the EtherCAT communication to restart, and the process data is transferred from the box.



SM2, PDO Assignment 0x1C12				
Index	Index of excluded PDOs	Size (byte.bit)	Name	PDO Content (index - name)
0x1600 (default)	0x1601	4.0	ENC Control compact	0x7000:01 [▶ 114] - Enable Latch C 0x7000:02 [▶ 114] - Enable Latch extern on positive edge 0x7000:03 [▶ 114] - Set counter 0x7000:04 [▶ 114] - Enable Latch extern on negative edge 0x7000:11 [▶ 114] - Set counter value (16-bit)
0x1601	0x1600	6.0	ENC Control	0x7000:01 [▶ 114] - Enable Latch C 0x7000:02 [▶ 114] - Enable Latch extern on positive edge 0x7000:03 [▶ 114] - Set counter 0x7000:04 [▶ 114] - Enable Latch extern on negative edge 0x7000:11 [▶ 114] - Set counter value (32-bit)

SM3, PDO Assignment 0x1C13				
Index	Index of excluded PDOs	Size (byte.bit)	Name	PDO Content (index - name)
0x1A00 (default)	0x1A01	6.0	ENC Status compact	0x6000:01 [▶ 113] - Latch C valid 0x6000:02 [▶ 113] - Latch extern valid 0x6000:03 [▶ 113] - Set counter done 0x6000:04 [▶ 113] - Counter underflow 0x6000:05 [▶ 113] - Counter overflow 0x6000:06 [▶ 113] - Status of input status 0x6000:07 [▶ 113] - Open circuit 0x6000:08 [▶ 113] - Extrapolation stall 0x6000:09 [▶ 113] - Status of input A 0x6000:0A [▶ 113] - Status of input B 0x6000:0B [▶ 113] - Status of input C 0x6000:0C [▶ 113] - Status of input gate 0x6000:0D [▶ 113] - Status of extern latch 0x1C32:20 [▶ 120] - Sync error 0x1800:07 [▶ 116] - TxPDO State 0x1800:09 [▶ 116] - TxPDO Toggle 0x6000:11 [▶ 113] - Counter value (16-Bit) 0x6000:12 [▶ 113] - Latch value (16-Bit)
0x1A01	0x1A00	10.0	ENC Status	0x6000:01 [▶ 113] - Latch C valid 0x6000:02 [▶ 113] - Latch extern valid 0x6000:03 [▶ 113] - Set counter done 0x6000:04 [▶ 113] - Counter underflow 0x6000:05 [▶ 113] - Counter overflow 0x6000:06 [▶ 113] - Status of input status 0x6000:07 [▶ 113] - Open circuit 0x6000:08 [▶ 113] - Extrapolation stall 0x6000:09 [▶ 113] - Status of input A 0x6000:0A [▶ 113] - Status of input B 0x6000:0B [▶ 113] - Status of input C 0x6000:0C [▶ 113] - Status of input gate 0x6000:0D [▶ 113] - Status of extern latch 0x1C32:20 [▶ 120] - Sync error 0x1800:07 [▶ 116] - TxPDO State 0x1800:09 [▶ 116] - TxPDO Toggle 0x6000:11 [▶ 113] - Counter value (32-Bit) 0x6000:12 [▶ 113] - Latch value (32-Bit)
0x1A02	0x1A03	4.0	ENC Frequency	0x6000:13 [▶ 113] - Frequency value
0x1A03	0x1A02	4.0	ENC Period	0x6000:14 [▶ 113] - Period value
0x1A04	0x1A05	8.0	ENC Timest.	0x6000:16 [▶ 113] - timestamp (64-bit)
0x1A05	0x1A04	4.0	ENC Timest. compact	0x6000:16 [▶ 113] - timestamp compact (32-bit)

### 5.3.3 DC (Distributed Clocks)

Describes whether the module is operated with support from distributed clocks:

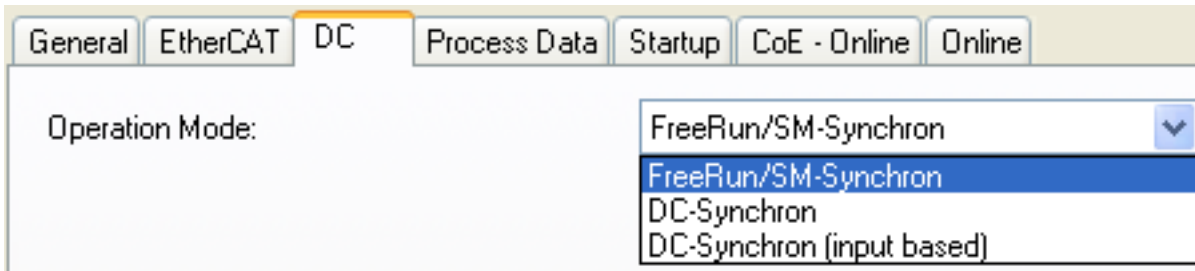

Fig. 17: Distributed Clocks

- **FreeRun:** The module operates frame-triggered. Cyclic operation is started via the SyncManagers during EtherCAT frame processing.
- **DC-Synchron:** Cyclic operation in the module is started by the local distributed clock at exact intervals. The start time is chosen such that it coincides with other output slaves in the EtherCAT system.
- **DC-Synchron (input based):** as DC-Synchron mode, with the cyclic start time chosen such that it coincides with other input slaves in the EtherCAT system.

### 5.3.4 Features CoE

Depending on the main PDO/optional PDOs further settings can be selected in the CoE list (CAN over EtherCAT).

#### **i** Parameterization via the CoE list (CAN over EtherCAT)

Please note the following general CoE notes when using/manipulating the CoE parameters:

- Keep a startup list if components have to be replaced
- Differentiation between online/offline dictionary, existence of current XML description
- “CoE-Reload” for resetting the changes

The following CoE settings from object 0x8000 are possible and shown here in their default settings, based on the EP5101-0011 as an example:

Index	Name	Flags	Value
8000:0	ENC Settings	RW	> 23 <
8000:01	Enable C reset	RW	FALSE
8000:02	Enable extern reset	RW	FALSE
8000:03	Enable up/down counter	RW	FALSE
8000:04	Gate polarity	RW	Enable pos. gate (1)
8000:08	Disable filter	RW	TRUE
8000:0A	Enable micro increments	RW	FALSE
8000:0B	Open circuit detection A	RW	TRUE
8000:0C	Open circuit detection B	RW	TRUE
8000:0D	Open circuit detection C	RW	FALSE
8000:0E	Reversion of rotation	RW	FALSE
8000:10	Extern reset polarity	RW	Rise (1)
8000:11	Frequency window	RW	0x2710 (10000)
8000:13	Frequency scaling	RW	0.01Hz (100)
8000:14	Period scaling	RW	100ns (100)
8000:15	Frequency resolution	RW	0.01Hz (100)
8000:16	Period resolution	RW	100ns (100)
8000:17	Frequency wait time	RW	0x0640 (1600)
A000:0	ENC Diag data	RO	> 3 <
F000:0	Modular device profile	RO	> 2 <
F008	Code word	RW	0x00000000 (0)
F010:0	Module list	RW	> 1 <

Fig. 18: Object 0x8000 - default, example: EP5101-0011

The parameters are explained in the object description chapter for the corresponding EtherCAT Box.

- Due to the different pin assignment, the following objects are not supported by the EP51x1-x002 modules!
  - 0x8000:02 - *Enable extern reset*
  - 0x8000:04 - *Gate polarity*
  - 0x8000:10 - *Extern reset polarity*
- Due to different firmware, the following objects are not supported by the EP5101-2011 module!
  - 0x8000:03 - *Enable up/down counter*
  - 0x8000:08 - *Disable filter*
  - 0x8000:0A - *Enable micro increments*

## Additional Notes

### Frequency

- The time window for the frequency calculation and the resolution can be parameterized in the CoE objects *Frequency window* 0x8000:11, *Frequency scaling* 0x8000:13, *Frequency resolution* 0x8000:15 and *Frequency wait time* 0x8000:17.
- The positive edges of track A are counted within the specified timeframe and the next edge including the time up to it are counted. The waiting time can be set in CoE object 0x8000:17 *Frequency Wait Time* (unit: ms). The default value is 1.6 sec. This is also the maximum value.
- The time window is 10 ms (default), min. 1  $\mu$ s. With the default setting it is possible to measure frequencies up to approx. 800 kHz. At higher frequencies a smaller value must be selected for the timeframe.
- The time is measured with a resolution of 100 ns.
- This calculation is carried out in the slave without reference to the distributed clocks system. It is therefore independent of the DC mode.
- No frequency measurement is possible if the counter is blocked by the gate. In this case the period can be measured regardless.
- A C or external reset restarts the frequency measurement. The last frequency value remains unchanged until a new frequency value is determined.

### Frequency measurement

- Basic unit 1  $\mu$ s: all window sizes

### Measurement sequence

- The measurement starts with a positive edge at track A. The current counter value and time (resolution: 100 ns) are stored.
- After the measuring window time has elapsed (index 0x8000:11), the system waits for the subsequent rising edge at track A, or a maximum of 1.6 seconds, or the time from *Frequency Wait Time* 0x8000:17.
- The frequency is calculated from the edge difference and the actual elapsed time.

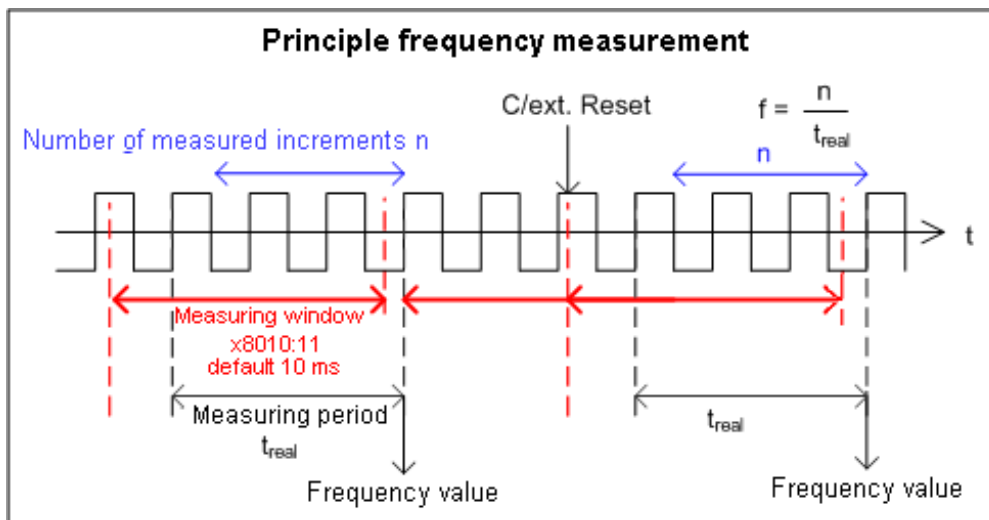

Fig. 19: Frequency measurement principle in enhanced operation mode

### Period calculation

- This calculation is carried out in the slave without reference to the distributed clocks system. It is therefore independent of the DC mode.
- During each cycle the interval between 2 positive edges of input A is counted.
- If no edge change occurs for approx. 1.6 s, any period specification is canceled.

## Latch

- Activation of latch C input (*Enable latch C* index 0x7000:01) and saving ("latching") of the counter value
  - The counter value is saved when the first external latch pulse (positive edge at input "C") is encountered after the bit has been set (TRUE) in *Enable latch C* index 0x7000:01 (this has priority over *Enable latch extern on positive / negative edge* 0x7000:02 / 0x7000:04). The subsequent pulses at the other inputs have no influence on the latch value in index 0x6000:12 if the bit is set.
  - Note for *Latch C valid* bit: A new counter value at the latch input can only be written once the value of the *Latch C valid* bit (index 0x6000:01) is FALSE.
- Activation of the external latch input ("Gate/Latch") and latching of the counter value (index 0x7000:02, 0x7000:04) (not for product version x002)
  - When the bit is set (TRUE) in *Enable latch extern on positive edge* index 0x7000:02, the counter value is saved on the latch input (index 0x6000:12) when the first external latch pulse with rising edge is encountered. The subsequent pulses have no influence on the latch value in index 0x6000:12.
  - When the bit is set (TRUE) in *Enable latch extern on negative edge* index 0x7000:04, the counter value is saved on the latch input (index 0x6000:12) when the first external latch pulse with falling edge is encountered. The subsequent pulses have no influence on the latch value in index 0x6000:12.
  - Note for *Latch extern valid* bit: A new counter value cannot be written to the latch input until the value of the *Latch extern valid* (index 0x6000:02) is FALSE.

## Reset

- Counter reset via input C:
  - To reset the counter, set the bit in *Enable latch C* index 0x8000:01.
- Resetting the counter via the external latch input (not for product version -x002)
  - For a reset via the external latch input, set the bit in *Enable extern reset* index 0x8000:02
  - *Extern reset polarity* index 0x8000:10 can be used to select the edge for setting the counter to zero.
    - Bit not set: Counter is set to zero with falling edge.
    - Bit set: Counter is set to zero with rising edge.
- The functions *Enable C reset* (0x8000:01) and *Enable extern reset* (0x8000:02) cannot be enabled simultaneously.

## Up/down counter

- The mode (encoder or up/down counter) can be set via *Enable up/down counter* index 0x8000:03. (not for product version -2011)
  - Click the corresponding row of the index to be parameterized,
  - enter the value "1" in the *SetValue* dialog and
  - confirm with OK.
- Set the gate polarity accordingly via object 0x8000:04.
- An additional option for reversing the direction of rotation is to set the *Reversion of rotation* bit index: 0x8000:0E.

**Overflow/underflow (not for product version -2011)**

- Overflow/underflow control is inactive in combination with an activated reset function (C/external).
- The underflow bit (0x6000:04) is set if an underflow ...00 ->...FF occurs. It is reset if 2/3 of the counter range are underrun.
- The overflow bit (0x6000:05) is set if an overflow FF...-> 0... occurs. It is reset if 1/3 of the counter range is exceeded.

**Open circuit detection**

- A separate open circuit detection can be activated for each of the channels A, B, and C (index 0x80n0:0B, 0x80n0:0C, 0x80n0:0D).
- Open circuit detection is activated for channels A and B by default.
- A differential voltage of < 1.5 V (typical, subject to modification) is interpreted as an open circuit.
- If an open circuit is detected, it is indicated as process data *Open circuit* = TRUE (bit in object *Open circuit* 0x6000:07 is set). An open circuit is also indicated separately in indices 0xA000:01 (track A), 0xA000:02 (track B), and 0xA000:03 (track C).
- TxPDO state also becomes TRUE if an open circuit is detected, since invalid data have to be assumed.

**Micro-increments**

- Works with and without distributed clocks, but it is only meaningful in conjunction with one of the DC modes.
- By setting the counter value only the integer component can be modified.
- The frequency measurement principle in enhanced operation mode:

DC supported microelements - Application for determination of an axis position

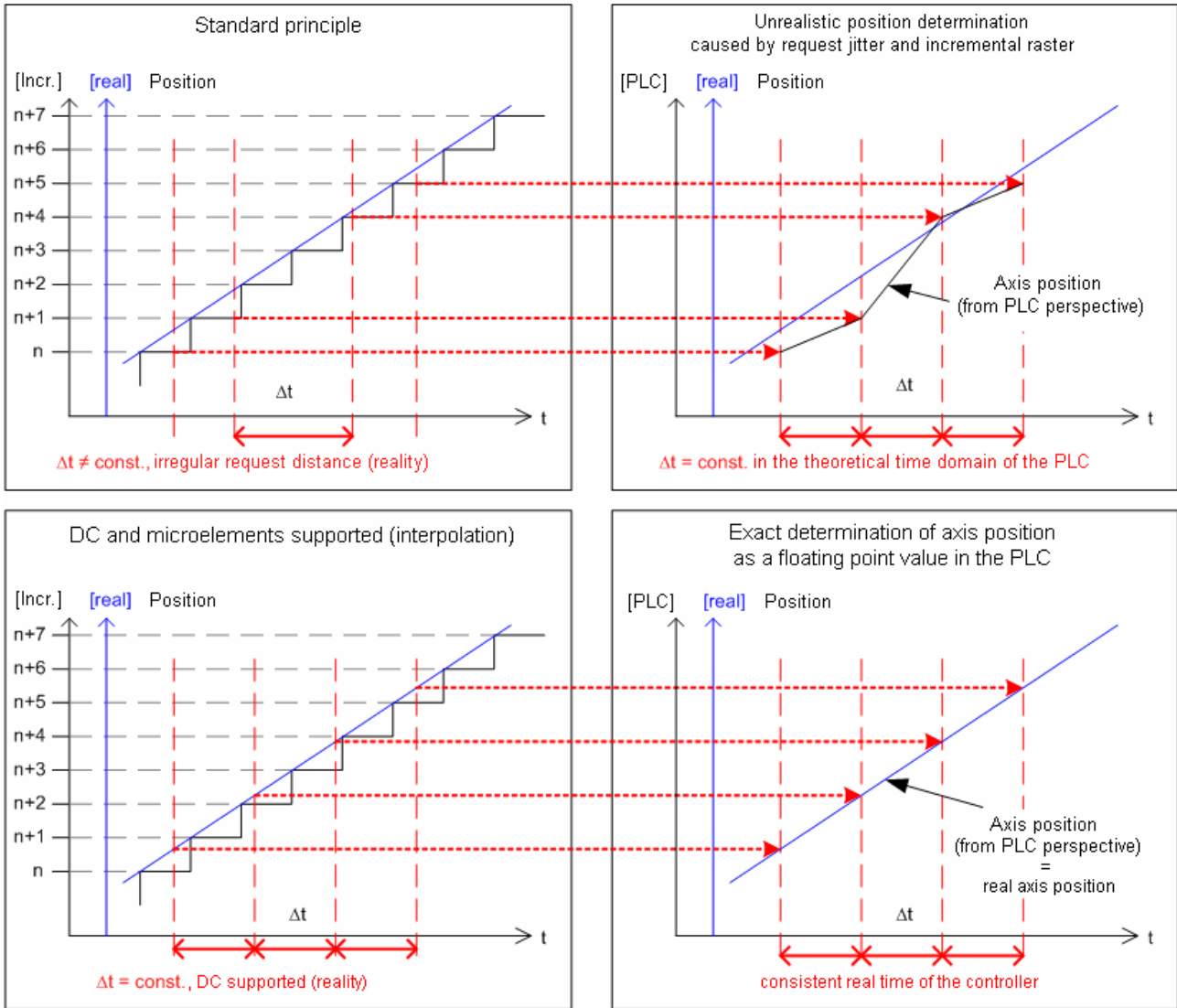

Fig. 20: DC-supported micro-increments

The highly constant query cycles (accuracy: 100 ns) of the distributed clocks systems enable the Box to interpolate axis positions between the counted encoder increments from a certain speed. The interpolation resolution is 8 bit, corresponding to 256 values. A standard encoder with 1,024 lines with 4-way evaluation and micro-increments thus becomes a high-resolution axis encoder with  $4096 \times 256 = 1,048,567$  lines.

If the velocity value falls below the minimum value, this is indicated by the object *Extrapolation stall* 0x6000:08 in the process data (not for product version -2011).

## 5.4 EP5001 - Interface signal level

The SSI interface works with differential signal levels conforms to RS422 / RS485.

The "typical output level" applies for a load of 60 ohm or higher.

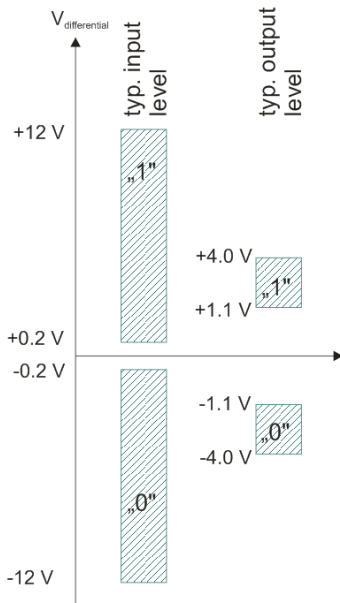

Single-ended signal levels are not supported.



## 5.5 EP5101 - Interface signal level

In differential mode the encoder input expects signal levels conforms to RS422 / RS485. The data are transferred without ground reference as voltage difference between two cables (signal A and inverted signal / A). The encoder input analyses differences greater than 200 mV as valid signals. The differential signal must be in the common mode range (<+13.2 V and >-10 V, with respect to GND) (cf. diagram). Signal levels outside this range can lead to destruction

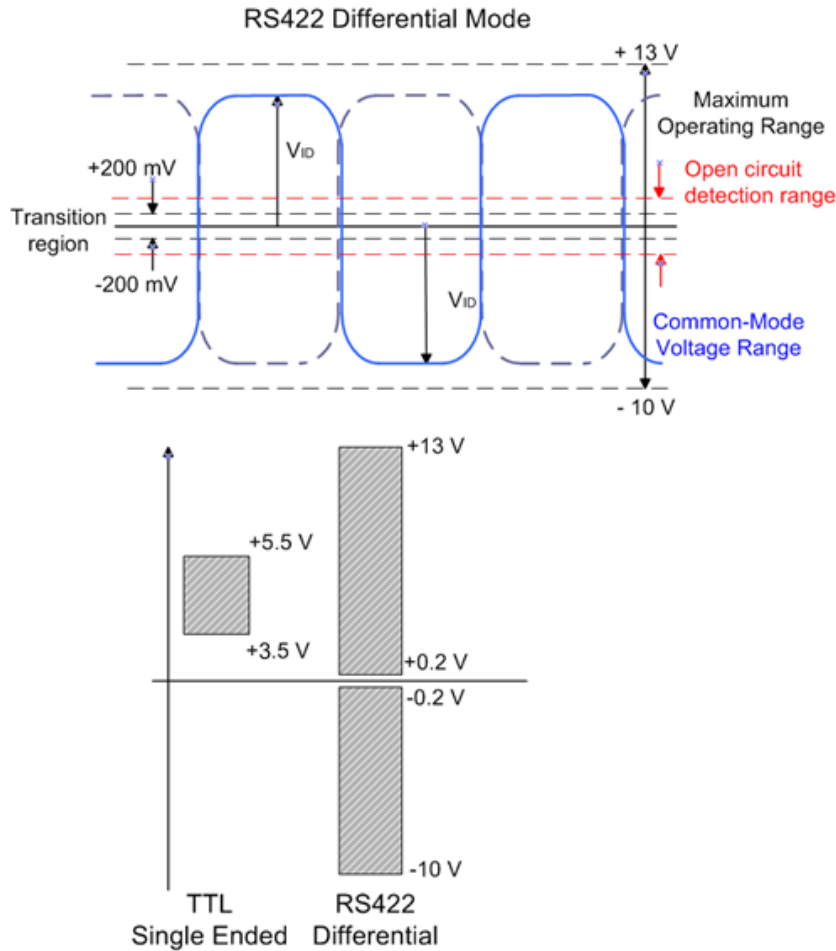

In differential mode only the voltage difference is evaluated, so that common-mode interference on the transmission link does not lead to corruption of the wanted signal, since any interference affects both cables simultaneously.

In single-ended mode the encoder input expects a signal level of nominally 3.5 V to 5.5 V.

A differential signal level between -1.5 V and +1.5 V is detected as wire breakage [► 70].

## 5.6 EP5151 - Interface signal level

The encoder input expects level after HTL (push-pull).

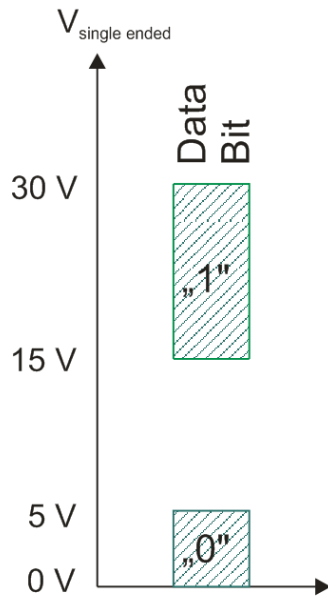

## 5.7 Restore the delivery state

You can restore the delivery state of the backup objects as follows:

1. Ensure that TwinCAT is running in Config mode.
2. In CoE object 1011:0 "Restore default parameters" select parameter 1011:01 "Subindex 001".

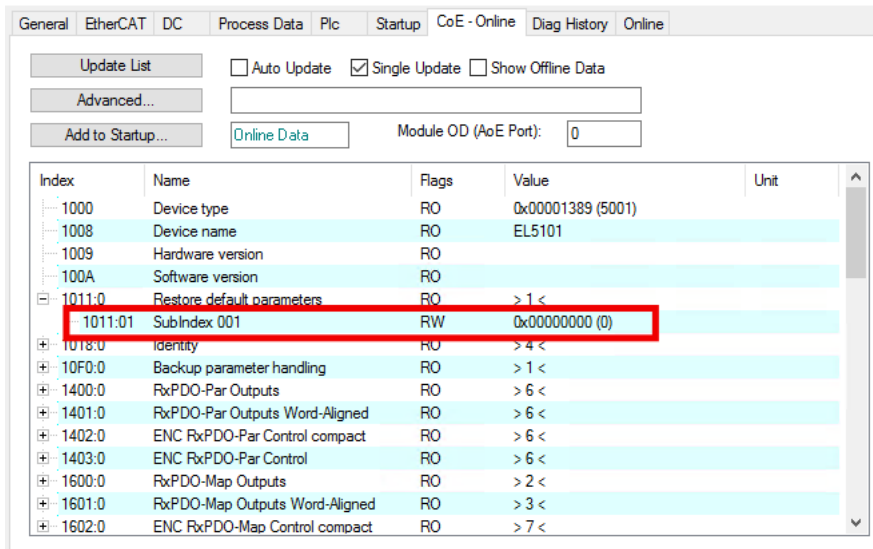

3. Double-click on "Subindex 001".  
⇒ The "Set Value Dialog" dialog box opens.
4. Enter the value 1684107116 in the "Dec" field.  
Alternatively: enter the value 0x64616F6C in the "Hex" field.

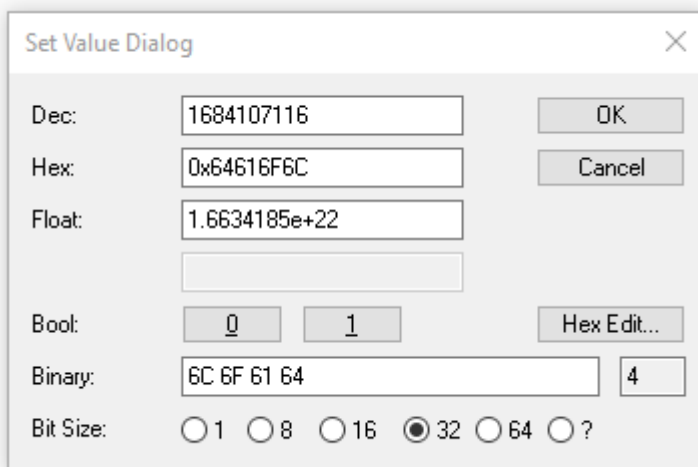

5. Confirm with "OK".  
⇒ All backup objects are reset to the delivery state.

### **i** Alternative restore value

With some older modules the backup objects can be changed with an alternative restore value:

Decimal value: 1819238756

Hexadecimal value: 0x6C6F6164

An incorrect entry for the restore value has no effect.

## 5.8 Decommissioning

**⚠ WARNING****Risk of electric shock!**

Bring the bus system into a safe, de-energized state before starting disassembly of the devices!

## 6 CoE parameters

### 6.1 EP5001-0002

#### ● Parameterization

**i** You can parameterize the box via the "CoE - Online" tab in TwinCAT.

#### ● EtherCAT XML Device Description

**i** The presentation matches that of the EtherCAT XML Device Description.  
Recommendation: download the latest XML file from <https://www.beckhoff.com/> and install it according to the installation instructions.

#### Introduction

The CoE overview contains objects for different intended applications:

- Objects required for parameterization during commissioning
- Objects intended for regular operation, e.g. through ADS access.
- Objects for indicating internal settings (may be fixed)

The following section first describes the objects required for normal operation, followed by a complete overview of missing objects.

#### Index 1000 Device type

Index (hex)	Name	Meaning	Data type	Flags	Default
1000:0	Device type	Device type of the EtherCAT slave: The Lo-Word contains the CoE profile used (5001). The Hi-Word contains the module profile according to the modular device profile.	UINT32	RO	0x01F51389 (32838537 <sub>dec</sub> )

#### Index 1008 Device name

Index (hex)	Name	Meaning	Data type	Flags	Default
1008:0	Device name	Device name of the EtherCAT slave	STRING	RO	EP5001-0002

#### Index 1009 Hardware version

Index (hex)	Name	Meaning	Data type	Flags	Default
1009:0	Hardware version	Hardware version of the EtherCAT slave	STRING	RO	-

#### Index 100A Software version

Index (hex)	Name	Meaning	Data type	Flags	Default
100A:0	Software version	Firmware version of the EtherCAT slave	STRING	RO	-

#### Index 1011 Restore default parameters

Index (hex)	Name	Meaning	Data type	Flags	Default
1011:0	Restore default parameters	Restore default parameters	UINT8	RO	0x01 (1 <sub>dec</sub> )
1011:01	SubIndex 001	If this object is set to "0x64616F6C" in the set value dialog, all backup objects are reset to their delivery state.	UINT32	RW	0x00000000 (0 <sub>dec</sub> )

**Index 1018 Identity**

Index (hex)	Name	Meaning	Data type	Flags	Default
1018:0	Identity	Information for identifying the slave	UINT8	RO	0x04 (4 <sub>dec</sub> )
1018:01	Vendor ID	Vendor ID of the EtherCAT slave	UINT32	RO	0x00000002 (2 <sub>dec</sub> )
1018:02	Product code	Product code of the EtherCAT slave	UINT32	RO	0x13894052 (327762002 <sub>dec</sub> )
1018:03	Revision	Revision number of the EtherCAT slave; the Low Word (bit 0-15) indicates the special terminal number, the High Word (bit 16-31) refers to the device description	UINT32	RO	0x00000000 (0 <sub>dec</sub> )
1018:04	Serial number	Serial number of the EtherCAT slave; the Low Byte (bit 0-7) of the Low Word contains the year of production, the High Byte (bit 8-15) of the Low Word contains the week of production, the High Word (bit 16-31) is 0	UINT32	RO	0x00000000 (0 <sub>dec</sub> )

**Index 10F0 Backup parameter handling**

Index (hex)	Name	Meaning	Data type	Flags	Default
10F0:0	Backup parameter handling	Information for standardized loading and saving of backup entries	UINT8	RO	0x01 (1 <sub>dec</sub> )
10F0:01	Checksum	Checksum across all backup entries of the EtherCAT slave	UINT32	RO	0x00000000 (0 <sub>dec</sub> )

**Index 1800 SSI TxPDO-Par Inputs**

Index (hex)	Name	Meaning	Data type	Flags	Default
1801:0	SSI TxPDO-Par Inputs	PDO parameter TxPDO 1	UINT8	RO	0x06 (6 <sub>dec</sub> )
1801:06	Exclude TxPDOs	Specifies the TxPDOs (index of TxPDO mapping objects) that must not be transferred together with TxPDO 1	OCTET-STRING[2]	RO	00 1A

**Index 1A00 SSI TxPDO-Map Inputs**

Index (hex)	Name	Meaning	Data type	Flags	Default
1A00:0	SSI TxPDO-Map Inputs	PDO Mapping TxPDO 1	UINT8	RO	0x08 (8 <sub>dec</sub> )
1A00:01	SubIndex 001	1. PDO Mapping entry (object 0x6000 (SSI Inputs), entry 0x01 (Data error))	UINT32	RO	0x6000:01, 1
1A00:02	SubIndex 002	2. PDO Mapping entry (object 0x6000 (SSI Inputs), entry 0x02 (Frame error))	UINT32	RO	0x6000:02, 1
1A00:03	SubIndex 003	3. PDO Mapping entry (object 0x6000 (SSI Inputs), entry 0x03 (Power failure))	UINT32	RO	0x6000:03, 1
1A00:04	SubIndex 004	4. PDO Mapping entry (10 bits align)	UINT32	RO	0x0000:00, 10
1A00:05	SubIndex 005	5. PDO Mapping entry (object 0x6000 (SSI Inputs), entry 0x0E (Sync error))	UINT32	RO	0x6000:0E, 1
1A00:06	SubIndex 006	6. PDO Mapping entry (object 0x6000 (SSI Inputs), entry 0x0F (TxPDO State))	UINT32	RO	0x6000:0F, 1
1A00:07	SubIndex 007	7. PDO Mapping entry (object 0x6000 (SSI Inputs), entry 0x10 (TxPDO Toggle))	UINT32	RO	0x6000:10, 1
1A00:08	SubIndex 008	8. PDO Mapping entry (object 0x6000 (SSI Inputs), entry 0x11 (Counter value))	UINT32	RO	0x6000:11, 32

**Index 1C00 Sync manager type**

Index (hex)	Name	Meaning	Data type	Flags	Default
1C00:0	Sync manager type	Using the Sync Managers	UINT8	RO	0x04 (4 <sub>dec</sub> )
1C00:01	SubIndex 001	Sync-Manager Type Channel 1: Mailbox Write	UINT8	RO	0x01 (1 <sub>dec</sub> )
1C00:02	SubIndex 002	Sync-Manager Type Channel 2: Mailbox Read	UINT8	RO	0x02 (2 <sub>dec</sub> )
1C00:03	SubIndex 003	Sync-Manager Type Channel 3: Process Data Write (Outputs)	UINT8	RO	0x03 (3 <sub>dec</sub> )
1C00:04	SubIndex 004	Sync-Manager Type Channel 4: Process Data Read (Inputs)	UINT8	RO	0x04 (4 <sub>dec</sub> )

**Index 1C12 RxPDO assign**

Index (hex)	Name	Meaning	Data type	Flags	Default
1C12:0	RxPDO assign	PDO Assign Outputs	UINT8	RW	0x00 (0 <sub>dec</sub> )

**Index 1C13 TxPDO assign**

Index (hex)	Name	Meaning	Data type	Flags	Default
1C13:0	TxPDO assign	PDO Assign Inputs	UINT8	RO	0x02 (2 <sub>dec</sub> )
1C13:01	SubIndex 001	1. allocated TxPDO (contains the index of the associated TxPDO mapping object)	UINT16	RO	0x1A00 (6656 <sub>dec</sub> )

## Index 1C33 SM input parameter

Index (hex)	Name	Meaning	Data type	Flags	Default
1C33:0	SM input parameter	Synchronization parameters for the inputs	UINT8	RO	0x20 (32 <sub>dec</sub> )
1C33:01	Sync mode	Current synchronization mode: <ul style="list-style-type: none"> <li>• 0: Free Run</li> <li>• 1: Synchron with SM 3 Event (no outputs available)</li> <li>• 2: DC - Synchron with SYNC0 Event</li> <li>• 3: DC - Synchron with SYNC1 Event</li> <li>• 34: Synchron with SM 2 Event (outputs available)</li> </ul>	UINT16	RW	0x0022 (34 <sub>dec</sub> )
1C33:02	Cycle time	Cycle time (in ns): <ul style="list-style-type: none"> <li>• Free Run: Cycle time of the local timer</li> <li>• Synchron with SM 2 Event: Master cycle time</li> <li>• DC mode: SYNC0/SYNC1 Cycle Time</li> </ul>	UINT32	RW	0x000F4240 (1000000 <sub>dec</sub> )
1C33:03	Shift time	Time between SYNC0 event and reading of the inputs (in ns, only DC mode)	UINT32	RO	0x00000000 (0 <sub>dec</sub> )
1C33:04	Sync modes supported	Supported synchronization modes: <ul style="list-style-type: none"> <li>• Bit 0: free run is supported</li> <li>• Bit 1: Synchron with SM 2 Event is supported (outputs available)</li> <li>• Bit 1: Synchron with SM 3 Event is supported (no outputs available)</li> <li>• Bit 2-3 = 01: DC mode is supported</li> <li>• Bit 4-5 = 01: Input shift through local event (outputs available)</li> <li>• Bit 4-5 = 10: Input shift with SYNC1 event (no outputs available)</li> <li>• Bit 14 = 1: dynamic times (measurement through writing of 0x1C33:08)</li> </ul>	UINT16	RO	0xC00B (49163 <sub>dec</sub> )
1C33:05	Minimum cycle time	Minimum cycle time (in ns)	UINT32	RO	0x00030D40 (0 <sub>dec</sub> )
1C33:06	Calc and copy time	Time between reading of the inputs and availability of the inputs for the master (in ns, only DC mode)	UINT32	RO	0x00000000 (0 <sub>dec</sub> )
1C33:07	Minimum delay time	-	UINT32	RO	0x000001B0 (7600 <sub>dec</sub> )
1C33:08	Command	With this entry the real required process data provision time can be measured. <ul style="list-style-type: none"> <li>• 0: Measurement of the local cycle time is stopped</li> <li>• 1: Measurement of the local cycle time is started</li> </ul> <p>The entries 0x1C33:03, 0x1C33:06, 0x1C33:09 are updated with the maximum measured values. For a subsequent measurement the measured values are reset</p>	UINT16	RW	0x0000 (0 <sub>dec</sub> )
1C33:09	Maximum Delay time	Time between SYNC1 event and reading of the inputs (in ns, only DC mode)	UINT32	RO	0x000001B0 (7600 <sub>dec</sub> )
1C33:0B	SM event missed counter	Number of missed SM events in OPERATIONAL (DC mode only)	UINT16	RO	0x0000 (0 <sub>dec</sub> )
1C33:0C	Cycle exceeded counter	Number of occasions the cycle time was exceeded in OPERATIONAL (cycle was not completed in time or the next cycle began too early)	UINT16	RO	0x0000 (0 <sub>dec</sub> )
1C33:0D	Shift too short counter	Number of occasions that the interval between SYNC0 and SYNC1 event was too short (DC mode only)	UINT16	RO	0x0000 (0 <sub>dec</sub> )
1C33:20	Sync error	The synchronization was not correct in the last cycle (outputs were output too late; DC mode only)	BOOLEAN	RO	0x00 (0 <sub>dec</sub> )



**Index 6000 SSI Inputs**

Index (hex)	Name	Meaning	Data type	Flags	Default
6000:0	SSI Inputs	Length of this object	UINT8	RO	0x11 (17 <sub>dec</sub> )
6000:01	Data error	SSI input error: - SSI without power supply - Broken wire at SSI data inputs D+ or D- - Data cables interchanged  If no data transmission occurs, the SSI input is on low signal level.	BOOLEAN	RO	0x00 (0 <sub>dec</sub> )
6000:02	Frame error	The data frame is wrong, i.e. the data frame was not terminated with zero (perhaps wire breakage on clock cables)	BOOLEAN	RO	0x00 (0 <sub>dec</sub> )
6000:03	Power failure	An encoder-specific error has occurred. This error bit is only displayed if it was previously enabled through <i>Enable power failure bit</i> index 0x8000:02 [► 81].	BOOLEAN	RO	0x00 (0 <sub>dec</sub> )
6000:0E	Sync error	The Sync error bit is only required for DC mode. It indicates whether a synchronization error has occurred during the previous cycle.  This means a SYNC signal was triggered in the Box, although no new process data were available (0=OK, 1=NOK).	BOOLEAN	RO	0x00 (0 <sub>dec</sub> )
6000:0F	TxPDO State	Validity of the data of the associated TxPDO (0 = valid, 1 = invalid).	BOOLEAN	RO	0x00 (0 <sub>dec</sub> )
6000:10	TxPDO Toggle	The TxPDO toggle is toggled by the slave when the data of the associated TxPDO is updated.	BOOLEAN	RO	0x00 (0 <sub>dec</sub> )
6000:11	Counter value	Counter value	UINT32	RO	0x00000000 (0 <sub>dec</sub> )

**Index 8000 SSI Settings**

Index (hex)	Name	Meaning	Data type	Flags	Default
8000:0	SSI Settings	Length of this object	UINT8	RO	0x13 (19 <sub>dec</sub> )
8000:01	Disable frame error	0: Frame error is not suppressed 1: Frame error is suppressed	BOOLEAN	RW	0x00 (0 <sub>dec</sub> )
8000:02	Enable power failure bit	0: Power failure bit is not active 1: Power failure bit is active: The last bit of the data frame (sensor-specific error bit) is shown as error bit in the <i>Power failure</i> object (index 0x6000:03) and bit 2 of the status word.	BOOLEAN	RW	0x00 (0 <sub>dec</sub> )
8000:03	Enable inhibit time	0: Inhibit time is not active 1: Inhibit time is active	BOOLEAN	RW	0x00 (0 <sub>dec</sub> )
8000:04	Enable test mode	0: Test mode is not active 1: Test mode is active	BOOLEAN	RW	0x00 (0 <sub>dec</sub> )
8000:06	SSI-coding	0: Binary code active 1: Gray code active	BIT1	RW	0x01 (1 <sub>dec</sub> )
8000:09	SSI-baudrate	0: reserved 1: 1250 kbaud 2: 1000 kbaud 3: 500 kBaud 4: 250 kbaud 5: 125 kbaud 6 - 65535: reserved	BIT3	RW	0x03 (3 <sub>dec</sub> )
8000:0F	SSI-frame type	0: Multi-turn analysis is active (25 bit data frame) 1: Single-turn-analysis is active (13 bit data frame) 2: Variable analysis is active. The length of the data frame (1 to 32 bits) is specified with object <i>SSI frame size</i> (index 0x8000:11).	BIT2	RW	0x00 (0 <sub>dec</sub> )
8000:11	SSI-frame size	Length of the SSI data frame (in bits)	UINT16	RW	0x0019 (25 <sub>dec</sub> )
8000:12	SSI-data length	Data length	UINT16	RW	0x0018 (24 <sub>dec</sub> )
8000:13	Min. inhibit time[µs]	Minimum inhibit time in µs (1 to 65535)	UINT16	RW	0x0000 (0 <sub>dec</sub> )

**Index 800D SSI Advanced Settings**

Index (hex)	Name	Meaning	Data type	Flags	Default
800D:0	SSI advanced settings	SSI advanced settings		RW	0x03 (3 <sub>dec</sub> )
800D:01	Encoder power supply on	Switches the 24 V supply voltage		RW	0x01 (1 <sub>dec</sub> )
800D:02	Encoder direction pin on	Switches the 24 V supply at the direction pin		RW	0x00 (0 <sub>dec</sub> )
800D:03	Encoder reset pin on	Switches the 24 V supply at the reset pin		RW	0x00 (0 <sub>dec</sub> )

**Index F000 Modular device profile**

Index (hex)	Name	Meaning	Data type	Flags	Default
F000:0	Modular device profile	General information for the modular device profile	UINT8	RO	0x02 (2 <sub>dec</sub> )
F000:01	Module index distance	Index distance of the objects of the individual channels	UINT16	RO	0x0010 (16 <sub>dec</sub> )
F000:02	Maximum number of modules	Number of channels	UINT16	RO	0x0001 (1 <sub>dec</sub> )

**Index F008 Code word**

Index (hex)	Name	Meaning	Data type	Flags	Default
F008:0	Code word	reserved	UINT32	RW	0x00000000 (0 <sub>dec</sub> )

**Index F010 Module list**

Index (hex)	Name	Meaning	Data type	Flags	Default
F010:0	Module list	Length of this object	UINT8	RW	0x02 (2 <sub>dec</sub> )
F010:01	SubIndex 001	-	UINT32	RW	0x000001F5 (501 <sub>dec</sub> )

## 6.2 EP5101-x002

### **i** Parameterization

You can parameterize the box via the "CoE - Online" tab in TwinCAT.

### **i** EtherCAT XML Device Description

The presentation matches that of the EtherCAT XML Device Description.  
 Recommendation: download the latest XML file from <https://www.beckhoff.com/> and install it according to the installation instructions.

### 6.2.1 Restore object

#### Index 1011 Restore default parameters

Index (hex)	Name	Meaning	Data type	Flags	Default
1011:0	Restore default parameters	Restore the default settings	UINT8	RO	0x01 (1 <sub>dec</sub> )
1011:01	SubIndex 001	If this object is set to " <b>0x64616F6C</b> " in the set value dialog, all backup objects are reset to their delivery state. Note: Some FW versions also accept the following input: " <b>0x6C6F6164</b> ".	UINT32	RW	0x00000000 (0 <sub>dec</sub> )

## 6.2.2 Configuration data

### Index 8000 ENC Settings

Index (hex)	Name	Meaning	Data type	Flags	Default
8000:0	ENC Settings	Maximum subindex	UINT8	RO	0x17 (23 <sub>dec</sub> )
8000:01	Enable C reset <a href="#">[▶ 69]</a>	The counter is reset via the C input.	BOOLEAN	RW	0x00 (0 <sub>dec</sub> )
8000:03	Enable up/down counter <a href="#">[▶ 69]</a>	Enablement of the up/down counter in place of the encoder with the bit set. Increments are counted at input A. Input B specifies the counting direction.	BOOLEAN	RW	0x00 (0 <sub>dec</sub> )
8000:08	Disable filter	0: Activates the input filter (inputs A, /A, B, /B, C, /C only) 1: Deactivates the input filter If a filter is activated a signal edge must be present for at least 2.4 μs in order to be counted as an increment.	BOOLEAN	RW	0x01 (1 <sub>dec</sub> )
8000:0A	Enable micro increments <a href="#">[▶ 70]</a>	If DC mode is activated, the Box interpolates micro-increments between the integer encoder increments. The lower 8 bits of the <i>Counter Value</i> are used in each case for the display. A 32-bit counter thus becomes a 24+8-bit counter, a 16-bit counter becomes an 8+8-bit counter.	BOOLEAN	RW	0x00 (0 <sub>dec</sub> )
8000:0B	Open circuit detection A <a href="#">[▶ 70]</a>	An open circuit on track A is indicated in object <i>Open circuit</i> (index 0x6000:07 <a href="#">[▶ 85]</a> ) and as a process data. Diagnosis is only possible if the corresponding input is wired differentially. A differential voltage < 3.5 V (typical, subject to change) is detected as a broken wire.	BOOLEAN	RW	0x01 (1 <sub>dec</sub> )
8000:0C	Open circuit detection B <a href="#">[▶ 70]</a>	An open circuit on track B is indicated in object <i>Open circuit</i> (index 0x6000:07 <a href="#">[▶ 85]</a> ) and as a process data. Diagnosis is only possible if the corresponding input is wired differentially. A differential voltage < 3.5 V (typical, subject to change) is detected as a broken wire.	BOOLEAN	RW	0x01 (1 <sub>dec</sub> )
8000:0D	Open circuit detection C <a href="#">[▶ 70]</a>	An open circuit on track C is indicated in object <i>Open circuit</i> (index 0x6000:07 <a href="#">[▶ 85]</a> ) and as a process data. Diagnosis is only possible if the corresponding input is wired differentially. A differential voltage < 3.5 V (typical, subject to change) is detected as a broken wire.	BOOLEAN	RW	0x00 (0 <sub>dec</sub> )
8000:0E	Reversion of rotation <a href="#">[▶ 69]</a>	Activates reversion of rotation	BOOLEAN	RW	0x00 (0 <sub>dec</sub> )
8000:11	Frequency window <a href="#">[▶ 68]</a>	This is the minimum time over which the frequency is determined; default value 10 ms [resolution: 1 μs]. The number of pulses in the timeframe + the following is measured. The maximum waiting time is specified in the <i>Frequency Wait Time</i> parameter. The number of pulses is divided by the actual time window size. The determined frequency is output in object <i>Frequency value</i> (index 0x6000:13 <a href="#">[▶ 85]</a> ) and as a process data. The frequency calculation is carried out locally without distributed clocks function.	UINT16	RW	0x2710 (10000 <sub>dec</sub> )
8000:13	Frequency scaling <a href="#">[▶ 68]</a>	Scaling of the frequency measurement (must be divided by this value to obtain the unit in Hz): 100: "0.01 Hz"	UINT16	RW	0x0064 (100 <sub>dec</sub> )
8000:14	Period scaling <a href="#">[▶ 68]</a>	Resolution of the period value in the process data: 100: "100 ns" period value is a multiple of 100 ns 500: "500 ns" period value is a multiple of 500 ns	UINT16	RW	0x0064 (100 <sub>dec</sub> )
8000:15	Frequency resolution <a href="#">[▶ 68]</a>	Resolution of the frequency measurement: 100: "0.01 Hz"	UINT16	RW	0x0064 (100 <sub>dec</sub> )
8000:16	Period resolution <a href="#">[▶ 68]</a>	Internal resolution of the period value measurement: 100: "100 ns" period value is a multiple of 100 ns The period is calculated internally with a resolution of 100 ns. The max. measurable period can then be approx. 1.6 seconds.  500: "500 ns" period value is a multiple of 500 ns Internally the period is calculated with 500 ns resolution. The maximum measurable period is approx. 32.7 ms. The resolution of the process data continues to be the value according to object <i>Period scaling</i> (index 0x8000:14) (e.g., 100 ns [default]).	UINT16	RW	0x0064 (100 <sub>dec</sub> )

Index (hex)	Name	Meaning	Data type	Flags	Default
8000:17	Frequency wait time [▶ 68]	Waiting time [ms] for frequency measurement Once the time specified in the <i>frequency window</i> has elapsed, the system waits for the next positive edge from track A. This enables the update speed for the <i>Frequency</i> process data to be optimized, depending on the expected frequencies. The minimum value to be entered here is twice the period value of the smallest measured frequency. $T \geq 2 * (1 / f_{min})$	UINT16	RW	0x0640 (1600 <sub>dec</sub> )

## 6.2.3 Input data

### Index 6000 ENC Inputs

Index (hex)	Name	Meaning	Data type	Flags	Default
6000:0	ENC Inputs	Maximum subindex	UINT8	RO	0x16 (22 <sub>dec</sub> )
6000:01	Latch C valid [▶ 69]	The counter value was latched with the "C" input. The data with <i>Latch Value</i> (Index 0x6000:12) corresponds to the latched value if the bit is set. To re-enable the latch input, <i>Enable latch C</i> (index 0x7000:01 [▶ 86]) must be canceled and then reset.	BOOLEAN	RO	0x00 (0 <sub>dec</sub> )
6000:03	Set counter done	The counter was set.	BOOLEAN	RO	0x00 (0 <sub>dec</sub> )
6000:04	Counter underflow [▶ 70]	The counter has passed the zero crossing backwards. Overflow/underflow control is inactive in combination with a reset function (C/external).	BOOLEAN	RO	0x00 (0 <sub>dec</sub> )
6000:05	Counter overflow [▶ 70]	Counter overflow. Overflow/underflow control is inactive in combination with a reset function (C/external).	BOOLEAN	RO	0x00 (0 <sub>dec</sub> )
6000:07	Open circuit [▶ 70]	Indicates an open circuit. Configuration via the objects <i>Open circuit detection A</i> Index 0x8000:0B [▶ 84], <i>Open circuit detection B</i> Index 0x8000:0C [▶ 84], <i>Open circuit detection C</i> Index 0x8000:0D [▶ 84]	BOOLEAN	RO	0x00 (0 <sub>dec</sub> )
6000:08	Extrapolation stall [▶ 70]	The extrapolated part of the counter is invalid.	BOOLEAN	RO	0x00 (0 <sub>dec</sub> )
6000:09	Status of input A	Status of input A	BOOLEAN	RO	0x00 (0 <sub>dec</sub> )
6000:0A	Status of input B	Status of input B	BOOLEAN	RO	0x00 (0 <sub>dec</sub> )
6000:0B	Status of input C	Status of input C	BOOLEAN	RO	0x00 (0 <sub>dec</sub> )
6000:0E	Sync error	The Sync error bit is only required for DC mode. It indicates whether a synchronization error has occurred during the previous cycle. This means a SYNC signal was triggered in the Box, although no new process data were available (0=OK, 1=NOK).	BOOLEAN	RO	0x00 (0 <sub>dec</sub> )
6000:0F	TxPDO State	Validity of the data of the associated TxPDO (0 = valid, 1 = invalid).	BOOLEAN	RO	0x00 (0 <sub>dec</sub> )
6000:10	TxPDO Toggle	The TxPDO toggle is toggled by the slave when the data of the associated TxPDO is updated.	BOOLEAN	RO	0x00 (0 <sub>dec</sub> )
6000:11	Counter value	Counter value	UINT32	RO	0x00000000 (0 <sub>dec</sub> )
6000:12	Latch value	Latch value	UINT32	RO	0x00000000 (0 <sub>dec</sub> )
6000:13	Frequency value [▶ 68]	The frequency (setting of the scaling and resolution in the objects <i>Frequency scaling</i> index 0x8000:13 [▶ 84] and <i>Frequency resolution</i> index 0x8000:15 [▶ 84])	UINT32	RO	0x00000000 (0 <sub>dec</sub> )
6000:14	Period value [▶ 68]	The period value (setting of the scaling and resolution in the objects <i>Period scaling</i> index 0x8000:14 [▶ 84] and <i>Period resolution</i> index 0x8000:16 [▶ 84])	UINT32	RO	0x00000000 (0 <sub>dec</sub> )
6000:16	Timestamp [▶ 56]	Timestamp of the last counter change	UINT64	RO	

## 6.2.4 Output data

### Index 7000 ENC Outputs

Index (hex)	Name	Meaning	Data type	Flags	Default
7000:0	ENC Outputs	Maximum subindex	UINT8	RO	0x11(17 <sub>dec</sub> )
7000:01	Enable latch C  ▶ 69	Activate latching via input "C".	BOOLEAN	RO	0x00 (0 <sub>dec</sub> )
7000:03	Set counter	Set counter value	BOOLEAN	RO	0x00 (0 <sub>dec</sub> )
7000:11	Set counter value	The counter value to be set via <i>Set counter</i> (index 0x7000:03).	UINT32	RO	0x00000000 ( <sub>dec</sub> )

## 6.2.5 Information / diagnostic data (channel specific)

### Index A000 ENC Diag data

Index (hex)	Name	Meaning	Data type	Flags	Default
A000:0	ENC Diag data	Maximum subindex	UINT8	RO	0x03 (3 <sub>dec</sub> )
A000:01	Open circuit A  ▶ 70	Open circuit on track A	BOOLEAN	RO	0x00 (0 <sub>dec</sub> )
A000:02	Open circuit B  ▶ 70	Open circuit on track B	BOOLEAN	RO	0x00 (0 <sub>dec</sub> )
A000:03	Open circuit C  ▶ 70	Open circuit on track C	BOOLEAN	RO	0x00 (0 <sub>dec</sub> )

## 6.2.6 Standard objects

The standard objects have the same meaning for all EtherCAT slaves.

### Index 1000 Device type

Index (hex)	Name	Meaning	Data type	Flags	Default
1000:0	Device type	Device type of the EtherCAT slave: The Lo-Word contains the CoE profile used (5001). The Hi-Word contains the module profile according to the modular device profile.	UINT32	RO	0x01FF1389 (33493897 <sub>dec</sub> )

### Index 1008 Device name

Index (hex)	Name	Meaning	Data type	Flags	Default
1008:0	Device name	Device name of the EtherCAT slave	STRING	RO	EP5101-0002 EP5101-1002

### Index 1009 Hardware version

Index (hex)	Name	Meaning	Data type	Flags	Default
1009:0	Hardware version	Hardware version of the EtherCAT slave	STRING	RO	-

### Index 100A Software version

Index (hex)	Name	Meaning	Data type	Flags	Default
100A:0	Software version	Firmware version of the EtherCAT slave	STRING	RO	-

### Index 1018 Identity

Index (hex)	Name	Meaning	Data type	Flags	Default
1018:0	Identity	Information for identifying the slave	UINT8	RO	0x04 (4 <sub>dec</sub> )
1018:01	Vendor ID	Vendor ID of the EtherCAT slave	UINT32	RO	0x00000002 (2 <sub>dec</sub> )
1018:02	Product code	Product code of the EtherCAT slave	UINT32	RO	0x13ED4052 (334315602 <sub>dec</sub> )
1018:03	Revision	Revision number of the EtherCAT slave; the Low Word (bit 0-15) indicates the special terminal number, the High Word (bit 16-31) refers to the device description	UINT32	RO	0x00000000 (0 <sub>dec</sub> )
1018:04	Serial number	Serial number of the EtherCAT slave; the Low Byte (bit 0-7) of the Low Word contains the year of production, the High Byte (bit 8-15) of the Low Word contains the week of production, the High Word (bit 16-31) is 0	UINT32	RO	0x00000000 (0 <sub>dec</sub> )

**Index 10F0 Backup parameter handling**

Index (hex)	Name	Meaning	Data type	Flags	Default
10F0:0	Backup parameter handling	Information for standardized loading and saving of backup entries	UINT8	RO	0x01 (1 <sub>dec</sub> )
10F0:01	Checksum	Checksum across all backup entries of the EtherCAT slave	UINT32	RO	0x00000000 (0 <sub>dec</sub> )

**Index 1400 ENC RxPDO-Par Control compact**

Index (hex)	Name	Meaning	Data type	Flags	Default
1400:0	ENC RxPDO-Par Control compact	PDO Parameter RxPDO 1	UINT8	RO	0x06 (6 <sub>dec</sub> )
1400:06	Exclude RxPDOs	Specifies the RxPDOs (index of RxPDO mapping objects) that must not be transferred together with RxPDO 1	OCTET-STRING[2]	RO	01 16

**Index 1401 ENC RxPDO-Par Control**

Index (hex)	Name	Meaning	Data type	Flags	Default
1401:0	ENC RxPDO-Par Control	PDO Parameter RxPDO 2	UINT8	RO	0x06 (6 <sub>dec</sub> )
1401:06	Exclude RxPDOs	Specifies the RxPDOs (index of RxPDO mapping objects) that must not be transferred together with RxPDO 2	OCTET-STRING[2]	RO	00 16

**Index 1600 ENC RxPDO Map Control compact (product version -002)**

Index (hex)	Name	Meaning	Data type	Flags	Default
1600:0	ENC RxPDO-Map Control compact	PDO Mapping RxPDO 3	UINT8	RO	0x06 (6 <sub>dec</sub> )
1600:01	SubIndex 001	1. PDO Mapping entry (object 0x7000 (ENC Outputs), entry 0x01 (Enable latch C))	UINT32	RO	0x7000:01, 1
1600:02	SubIndex 002	2. PDO Mapping entry (1 bit align)	UINT32	RO	0x0000:00, 1
1600:03	SubIndex 003	3. PDO Mapping entry (object 0x7000 (ENC Outputs), entry 0x03 (Set counter))	UINT32	RO	0x7000:03, 1
1600:04	SubIndex 004	4. PDO Mapping entry (5 bits align)	UINT32	RO	0x0000:00, 5
1600:05	SubIndex 005	5. PDO Mapping entry (8 bits align)	UINT32	RO	0x0000:00, 8
1600:06	SubIndex 006	6. PDO Mapping entry (object 0x7000 (ENC Outputs), entry 0x11 (Set counter value))	UINT32	RO	0x7000:11, 16
1600:07	SubIndex 007	7. reserved	UINT32	RO	-

**Index 1600 ENC RxPDO Map Control compact (product version -1002)**

Index (hex)	Name	Meaning	Data type	Flags	Default
1600:0	ENC RxPDO-Map Control compact	PDO Mapping RxPDO 3	UINT8	RO	0x07 (7 <sub>dec</sub> )
1600:01	SubIndex 001	1. PDO Mapping entry (object 0x7000 (ENC Outputs), entry 0x01 (Enable latch C))	UINT32	RO	0x7000:01, 1
1600:02	SubIndex 002	2. PDO Mapping entry (1 bit align)	UINT32	RO	0x0000:00, 1
1600:03	SubIndex 003	3. PDO Mapping entry (object 0x7000 (ENC Outputs), entry 0x03 (Set counter))	UINT32	RO	0x7000:03, 1
1600:04	SubIndex 004	4. PDO Mapping entry (1 bits align)	UINT32	RO	0x0000:00, 1
1600:05	SubIndex 005	5. PDO Mapping entry (4 bits align)	UINT32	RO	0x0000:00, 4
1600:06	SubIndex 006	6. PDO Mapping entry (8 bits align)	UINT32	RO	0x0000:00, 8
1600:07	SubIndex 007	7. PDO Mapping entry (object 0x7000 (ENC Outputs), entry 0x11 (Set counter value))	UINT32	RO	0x7000:11, 16

**Index 1601 ENC RxPDO Map Control (product version -0002)**

Index (hex)	Name	Meaning	Data type	Flags	Default
1601:0	ENC RxPDO-Map Control compact	PDO Mapping RxPDO	UINT8	RO	0x06 (6 <sub>dec</sub> )
1601:01	SubIndex 001	1. PDO Mapping entry (object 0x7000 (ENC Outputs), entry 0x01 (Enable latch C))	UINT32	RO	0x7000:01,1
1601:02	SubIndex 002	2. PDO Mapping entry (1 bit align)	UINT32	RO	0x0000:00,1
1601:03	SubIndex 003	3. PDO Mapping entry (object 0x7000 (ENC Outputs), entry 0x03 (Set counter))	UINT32	RO	0x7000:03,1
1601:04	SubIndex 004	4. PDO Mapping entry (5 bits align)	UINT32	RO	0x0000:00,5
1601:05	SubIndex 005	5. PDO Mapping entry (8 bits align)	UINT32	RO	0x0000:00,8
1601:06	SubIndex 006	6. PDO Mapping entry (object 0x7000 (ENC Outputs), entry 0x11 (Set counter value))	UINT32	RO	0x7000:11,32
1601:07	SubIndex 007	7. reserved	UINT32	RO	-

**Index 1601 ENC RxPDO Map Control (product version -1002)**

Index (hex)	Name	Meaning	Data type	Flags	Default
1601:0	ENC RxPDO-Map Control compact	PDO Mapping RxPDO	UINT8	RO	0x07 (7 <sub>dec</sub> )
1601:01	SubIndex 001	1. PDO Mapping entry (object 0x7000 (ENC Outputs), entry 0x01 (Enable latch C))	UINT32	RO	0x7000:01,1
1601:02	SubIndex 002	2. PDO Mapping entry (1 bit align)	UINT32	RO	0x0000:00,1
1601:03	SubIndex 003	3. PDO Mapping entry (object 0x7000 (ENC Outputs), entry 0x03 (Set counter))	UINT32	RO	0x7000:03,1
1601:04	SubIndex 004	4. PDO Mapping entry (object 0x7000 (ENC Outputs), entry 0x04 (Enable latch extern on negative edge))	UINT32	RO	0x7000:04,1
1601:05	SubIndex 005	5. PDO Mapping entry (4 bits align)	UINT32	RO	0x0000:00,4
1601:06	SubIndex 006	6. PDO Mapping entry (8 bits align)	UINT32	RO	0x0000:00,8
1601:07	SubIndex 007	7. PDO Mapping entry (object 0x7000 (ENC Outputs), entry 0x11 (Set counter value))	UINT32	RO	0x7000:11,32

**Index 1800 ENC TxPDO-Par Status compact**

Index (hex)	Name	Meaning	Data type	Flags	Default
1800:0	ENC TxPDO-Par Status compact	PDO parameter TxPDO 1	UINT8	RO	0x09 (9 <sub>dec</sub> )
1800:06	Exclude TxPDOs	Specifies the TxPDOs (index of TxPDO mapping objects) that must not be transferred together with TxPDO 1.	OCTET-STRING[2]	RO	01 1A
1800:07	TxPDO State	The TxPDO state is set if it was not possible to correctly read in the associated input data.	BOOLEAN	RO	0x00 (0 <sub>dec</sub> )
1800:09	TxPDO Toggle	The TxPDO toggle is toggled with each update the corresponding input data.	BOOLEAN	RO	0x00 (0 <sub>dec</sub> )

**Index 1801 ENC TxPDO-Par Status**

Index (hex)	Name	Meaning	Data type	Flags	Default
1801:0	ENC TxPDO-Par Status	PDO parameter TxPDO 2	UINT8	RO	0x09 (9 <sub>dec</sub> )
1801:06	Exclude TxPDOs	Specifies the TxPDOs (index of TxPDO mapping objects) that must not be transferred together with TxPDO 2.	OCTET-STRING[2]	RO	00 1A
1801:07	TxPDO State	The TxPDO state is set if it was not possible to correctly read in the associated input data.	BOOLEAN	RO	0x00 (0 <sub>dec</sub> )
1801:09	TxPDO Toggle	The TxPDO toggle is toggled with each update the corresponding input data.	BOOLEAN	RO	0x00 (0 <sub>dec</sub> )

**Index 1802 ENC TxPDO-Par Frequency**

Index (hex)	Name	Meaning	Data type	Flags	Default
1802:0	ENC TxPDO-Par Frequency	PDO parameter TxPDO 3	UINT8	RO	0x06 (6 <sub>dec</sub> )
1802:06	Exclude TxPDOs	Specifies the TxPDOs (index of TxPDO mapping objects) that must not be transferred together with TxPDO 3.	OCTET-STRING[2]	RO	03 1A



**Index 1803 ENC TxPDO-Par Period**

Index (hex)	Name	Meaning	Data type	Flags	Default
1803:0	ENC TxPDO-Par Period	PDO parameter TxPDO 4	UINT8	RO	0x06 (6 <sub>dec</sub> )
1803:06	Exclude TxPDOs	Specifies the TxPDOs (index of TxPDO mapping objects) that must not be transferred together with TxPDO 4.	OCTET-STRING[2]	RO	02 1A

**Index 1804 ENC TxPDO-Par Timestamp**

Index (hex)	Name	Meaning	Data type	Flags	Default
1804:0	ENC TxPDO-Par Timestamp	PDO parameter TxPDO 5	UINT8	RO	0x06 (6 <sub>dec</sub> )
1804:06	Exclude TxPDOs	Specifies the TxPDOs (index of TxPDO mapping objects) that must not be transferred together with TxPDO 5.	OCTET-STRING[2]	RO	05 1A

**Index 1805 ENC TxPDO-Par Timestamp compact**

Index (hex)	Name	Meaning	Data type	Flags	Default
1805:0	ENC TxPDO-Par Timestamp compact	PDO parameter TxPDO 6	UINT8	RO	0x06 (6 <sub>dec</sub> )
1805:06	Exclude TxPDOs	Specifies the TxPDOs (index of TxPDO mapping objects) that must not be transferred together with TxPDO 6.	OCTET-STRING[2]	RO	04 1A

**Index 1A00 ENC TxPDO Map Status compact (product version -0002)**

Index (hex)	Name	Meaning	Data type	Flags	Default
1A00:0	ENC TxPDO-Map Status compact	ENC TxPDO-Map Status compact	UINT8	RO	0x011 (17 <sub>dec</sub> )
1A00:01	SubIndex 001	1. PDO Mapping entry (object 0x6000 (ENC Inputs), entry 0x01 (Latch C valid))	UINT32	RO	0x6000:01, 1
1A00:02	SubIndex 002	2. PDO Mapping entry (1 bit align)	UINT32	RO	0x0000:00, 1
1A00:03	SubIndex 003	3. PDO Mapping entry (object 0x6000 (ENC Inputs), entry 0x03 (Set counter done))	UINT32	RO	0x6000:03, 1
1A00:04	SubIndex 004	4. PDO Mapping entry (object 0x6000 (ENC Inputs), entry 0x04 (Counter underflow))	UINT32	RO	0x6000:04, 1
1A00:05	SubIndex 005	5. PDO Mapping entry (object 0x6000 (ENC Inputs), entry 0x05 (Counter overflow))	UINT32	RO	0x6000:05, 1
1A00:06	SubIndex 006	6. PDO Mapping entry (1 bit align)	UINT32	RO	0x0000:00, 1
1A00:07	SubIndex 007	7. PDO mapping entry (object 0x6000 (ENC Inputs), entry 0x07 (open circuit))	UINT32	RO	0x6000:07, 1
1A00:08	SubIndex 008	8. PDO Mapping entry (object 0x6000 (ENC Inputs), entry 0x08 (Extrapolation stall))	UINT32	RO	0x6000:08, 1
1A00:09	SubIndex 009	9. PDO Mapping entry (object 0x6000 (ENC Inputs), entry 0x09 (Status of input A))	UINT32	RO	0x6000:09, 1
1A00:0A	SubIndex 010	10. PDO Mapping entry (object 0x6000 (ENC Inputs), entry 0x0A (Status of input B))	UINT32	RO	0x6000:0A, 1
1A00:0B	SubIndex 011	11. PDO Mapping entry (object 0x6000 (ENC Inputs), entry 0x0B (Status of input C))	UINT32	RO	0x6000:0B, 1
1A00:0C	SubIndex 012	12. PDO Mapping entry (2 bit align)	UINT32	RO	0x0000:00, 2
1A00:0D	SubIndex 013	13. PDO Mapping entry (object 0x1C32 (SM output parameter), entry 0x20 (Sync error))	UINT32	RO	0x1C32:20, 1
1A00:0E	SubIndex 014	14. PDO mapping entry (object 0x1800 (ENC TxPDO Par Status compact), entry 0x07 (TxPDO state))	UINT32	RO	0x1800:07, 1
1A00:0F	SubIndex 015	15. PDO Mapping entry (object 0x1800 (ENC TxPDO-Par Status compact), entry 0x09 (TxPDO Toggle))	UINT32	RO	0x1800:09, 1
1A00:10	SubIndex 016	16. PDO Mapping entry (object 0x6000 (ENC Inputs), entry 0x11 (Counter value))	UINT32	RO	0x6000:11, 16
1A00:11	SubIndex 017	17. PDO Mapping entry (object 0x6000 (ENC Inputs), entry 0x12 (Latch value))	UINT32	RO	0x6000:12, 16
1A00:12	SubIndex 018	reserved	UINT32	RO	-

## Index 1A00 ENC TxPDO Map Status compact (product version -1002)

Index (hex)	Name	Meaning	Data type	Flags	Default
1A00:0	ENC TxPDO-Map Status compact	ENC TxPDO-Map Status compact	UINT8	RO	0x012 (18 <sub>dec</sub> )
1A00:01	SubIndex 001	1. PDO Mapping entry (object 0x6000 (ENC Inputs), entry 0x01 (Latch C valid))	UINT32	RO	0x6000:01, 1
1A00:02	SubIndex 002	2. PDO Mapping entry (1 bit align)	UINT32	RO	0x0000:00, 1
1A00:03	SubIndex 003	3. PDO Mapping entry (object 0x6000 (ENC Inputs), entry 0x03 (Set counter done))	UINT32	RO	0x6000:03, 1
1A00:04	SubIndex 004	4. PDO Mapping entry (object 0x6000 (ENC Inputs), entry 0x04 (Counter underflow))	UINT32	RO	0x6000:04, 1
1A00:05	SubIndex 005	5. PDO Mapping entry (object 0x6000 (ENC Inputs), entry 0x05 (Counter overflow))	UINT32	RO	0x6000:05, 1
1A00:06	SubIndex 006	6. PDO Mapping entry (1 bit align)	UINT32	RO	0x0000:00, 1
1A00:07	SubIndex 007	7. PDO mapping entry (object 0x6000 (ENC Inputs), entry 0x07 (open circuit))	UINT32	RO	0x6000:07, 1
1A00:08	SubIndex 008	8. PDO Mapping entry (object 0x6000 (ENC Inputs), entry 0x08 (Extrapolation stall))	UINT32	RO	0x6000:08, 1
1A00:09	SubIndex 009	9. PDO Mapping entry (object 0x6000 (ENC Inputs), entry 0x09 (Status of input A))	UINT32	RO	0x6000:09, 1
1A00:0A	SubIndex 010	10. PDO Mapping entry (object 0x6000 (ENC Inputs), entry 0x0A (Status of input B))	UINT32	RO	0x6000:0A, 1
1A00:0B	SubIndex 011	11. PDO Mapping entry (object 0x6000 (ENC Inputs), entry 0x0B (Status of input C))	UINT32	RO	0x6000:0B, 1
1A00:0C	SubIndex 012	12. PDO Mapping entry (1 bit align)	UINT32	RO	0x0000:00, 1
1A00:0D	SubIndex 013	13. PDO Mapping entry (1 bit align)	UINT32	RO	0x0000:00, 1
1A00:0E	SubIndex 014	14. PDO Mapping entry (object 0x1C32 (SM output parameter), entry 0x20 (Sync error))	UINT32	RO	0x1C32:20, 1
1A00:0F	SubIndex 015	15. PDO mapping entry (object 0x1800 (ENC TxPDO Par Status compact), entry 0x07 (TxPDO state))	UINT32	RO	0x1800:07, 1
1A00:10	SubIndex 016	16. PDO Mapping entry (object 0x1800 (ENC TxPDO-Par Status compact), entry 0x09 (TxPDO Toggle))	UINT32	RO	0x1800:09, 1
1A00:11	SubIndex 017	17. PDO Mapping entry (object 0x6000 (ENC Inputs), entry 0x11 (Counter value))	UINT32	RO	0x6000:11, 16
1A00:12	SubIndex 018	18. PDO Mapping entry (object 0x6000 (ENC Inputs), entry 0x12 (Latch value))	UINT32	RO	0x6000:12, 16

**Index 1A01 ENC TxPDO Map Status (product version -0002)**

Index (hex)	Name	Meaning	Data type	Flags	Default
1A01:0	ENC TxPDO-Map Status compact	ENC TxPDO-Map Status	UINT8	RO	0x11 (17 <sub>dec</sub> )
1A01:01	SubIndex 001	1. PDO Mapping entry (object 0x6000 (ENC Inputs), entry 0x01 (Latch C valid))	UINT32	RO	0x6000:01, 1
1A01:02	SubIndex 002	2. PDO Mapping entry (1 bit align)	UINT32	RO	0x0000:00, 1
1A01:03	SubIndex 003	3. PDO Mapping entry (object 0x6000 (ENC Inputs), entry 0x03 (Set counter done))	UINT32	RO	0x6000:03, 1
1A01:04	SubIndex 004	4. PDO Mapping entry (object 0x6000 (ENC Inputs), entry 0x04 (Counter underflow))	UINT32	RO	0x6000:04, 1
1A01:05	SubIndex 005	5. PDO Mapping entry (object 0x6000 (ENC Inputs), entry 0x05 (Counter overflow))	UINT32	RO	0x6000:05, 1
1A01:06	SubIndex 006	6. PDO Mapping entry (1 bit align)	UINT32	RO	0x0000:00, 1
1A01:07	SubIndex 007	7. PDO mapping entry (object 0x6000 (ENC Inputs), entry 0x07 (open circuit))	UINT32	RO	0x6000:07, 1
1A01:08	SubIndex 008	8. PDO Mapping entry (object 0x6000 (ENC Inputs), entry 0x08 (Extrapolation stall))	UINT32	RO	0x6000:08, 1
1A01:09	SubIndex 009	9. PDO Mapping entry (object 0x6000 (ENC Inputs), entry 0x09 (Status of input A))	UINT32	RO	0x6000:09, 1
1A01:0A	SubIndex 010	10. PDO Mapping entry (object 0x6000 (ENC Inputs), entry 0x0A (Status of input B))	UINT32	RO	0x6000:0A, 1
1A01:0B	SubIndex 011	11. PDO Mapping entry (object 0x6000 (ENC Inputs), entry 0x0B (Status of input C))	UINT32	RO	0x6000:0B, 1
1A01:0C	SubIndex 012	12. PDO Mapping entry (2 bit align)	UINT32	RO	0x0000:00, 2
1A01:0D	SubIndex 013	13. PDO Mapping entry (object 0x1C32 (SM output parameter), entry 0x20 (Sync error))	UINT32	RO	0x1C32:20, 1
1A01:0E	SubIndex 014	14. PDO mapping entry (object 0x1801 (ENC TxPDO Par Status), entry 0x07 (TxPDO state))	UINT32	RO	0x1801:07, 1
1A01:0F	SubIndex 015	15. PDO Mapping entry (object 0x1801 (ENC TxPDO-Par Status), entry 0x09 (TxPDO Toggle))	UINT32	RO	0x1801:09, 1
1A01:10	SubIndex 016	16. PDO Mapping entry (object 0x6000 (ENC Inputs), entry 0x11 (Counter value))	UINT32	RO	0x6000:11, 32
1A01:11	SubIndex 017	17. PDO Mapping entry (object 0x6000 (ENC Inputs), entry 0x12 (Latch value))	UINT32	RO	0x6000:12, 32
1A01:12	SubIndex 018	18. reserved	UINT32	RO	-

**Index 1A01 ENC TxPDO Map Status (product version -1002)**

Index (hex)	Name	Meaning	Data type	Flags	Default
1A01:0	ENC TxPDO-Map Status compact	ENC TxPDO-Map Status	UINT8	RO	0x12 (18 <sub>dec</sub> )
1A01:01	SubIndex 001	1. PDO Mapping entry (object 0x6000 (ENC Inputs), entry 0x01 (Latch C valid))	UINT32	RO	0x6000:01, 1
1A01:02	SubIndex 002	2. PDO Mapping entry (1 bit align)	UINT32	RO	0x0000:00, 1
1A01:03	SubIndex 003	3. PDO Mapping entry (object 0x6000 (ENC Inputs), entry 0x03 (Set counter done))	UINT32	RO	0x6000:03, 1
1A01:04	SubIndex 004	4. PDO Mapping entry (object 0x6000 (ENC Inputs), entry 0x04 (Counter underflow))	UINT32	RO	0x6000:04, 1
1A01:05	SubIndex 005	5. PDO Mapping entry (object 0x6000 (ENC Inputs), entry 0x05 (Counter overflow))	UINT32	RO	0x6000:05, 1
1A01:06	SubIndex 006	6. PDO Mapping entry (1 bit align)	UINT32	RO	0x0000:00, 1
1A01:07	SubIndex 007	7. PDO mapping entry (object 0x6000 (ENC Inputs), entry 0x07 (open circuit))	UINT32	RO	0x6000:07, 1
1A01:08	SubIndex 008	8. PDO Mapping entry (object 0x6000 (ENC Inputs), entry 0x08 (Extrapolation stall))	UINT32	RO	0x6000:08, 1
1A01:09	SubIndex 009	9. PDO Mapping entry (object 0x6000 (ENC Inputs), entry 0x09 (Status of input A))	UINT32	RO	0x6000:09, 1
1A01:0A	SubIndex 010	10. PDO Mapping entry (object 0x6000 (ENC Inputs), entry 0x0A (Status of input B))	UINT32	RO	0x6000:0A, 1
1A01:0B	SubIndex 011	11. PDO Mapping entry (object 0x6000 (ENC Inputs), entry 0x0B (Status of input C))	UINT32	RO	0x6000:0B, 1
1A01:0C	SubIndex 012	12. PDO Mapping entry (1 bit align)	UINT32	RO	0x0000:00, 1
1A01:0D	SubIndex 013	13. PDO Mapping entry (1 bit align)	UINT32	RO	0x0000:00, 1
1A01:0E	SubIndex 014	14. PDO Mapping entry (object 0x1C32 (SM output parameter), entry 0x20 (Sync error))	UINT32	RO	0x1C32:20, 1
1A01:0F	SubIndex 015	15. PDO mapping entry (object 0x1801 (ENC TxPDO Par Status), entry 0x07 (TxPDO state))	UINT32	RO	0x1801:07, 1
1A01:10	SubIndex 016	16. PDO Mapping entry (object 0x1801 (ENC TxPDO-Par Status), entry 0x09 (TxPDO Toggle))	UINT32	RO	0x1801:09, 1
1A01:11	SubIndex 017	17. PDO Mapping entry (object 0x6000 (ENC Inputs), entry 0x11 (Counter value))	UINT32	RO	0x6000:11, 32
1A01:12	SubIndex 018	18. PDO Mapping entry (object 0x6000 (ENC Inputs), entry 0x12 (Latch value))	UINT32	RO	0x6000:12, 32

**Index 1A02 ENC TxPDO-Map Frequency**

Index (hex)	Name	Meaning	Data type	Flags	Default
1A02:0	TxPDO map frequency	PDO Mapping TxPDO	UINT8	RO	0x01 (1 <sub>dec</sub> )
1A02:01	SubIndex 001	1. PDO Mapping entry (object 0x6000 (ENC Inputs), entry 0x13 (Frequency value))	UINT32	RO	0x6000:13, 32

**Index 1A03 ENC TxPDO-Map Period**

Index (hex)	Name	Meaning	Data type	Flags	Default
1A03:0	ENC TxPDO-Map Period	ENC TxPDO-Map Period	UINT8	RO	0x01 (1 <sub>dec</sub> )
1A03:01	SubIndex 001	1. PDO Mapping entry (object 0x6000 (ENC Inputs), entry 0x14 (Period value))	UINT32	RO	0x6000:14, 32

**Index 1A04 ENC TxPDO-Map Timest.**

Index (hex)	Name	Meaning	Data type	Flags	Default
1A04:0	ENC TxPDO-Map Timest.	ENC TxPDO-Map Timest.	UINT8	RO	0x01 (1 <sub>dec</sub> )
1A04:01	SubIndex 001	1. PDO Mapping entry (object 0x6000 (ENC Inputs), entry 0x16 (Timestamp))	UINT32	RO	0x6000:16, 64

**Index 1A05 ENC TxPDO-Map Timest. compact**

Index (hex)	Name	Meaning	Data type	Flags	Default
1A05:0	ENC TxPDO-Map Timest. compact	ENC TxPDO-Map Timest. compact	UINT8	RO	0x01 (1 <sub>dec</sub> )
1A05:01	SubIndex 001	1. PDO Mapping entry (object 0x6000 (ENC Inputs), entry 0x16 (Timestamp))	UINT32	RO	0x6000:16, 32

**Index 1C00 Sync manager type**

Index (hex)	Name	Meaning	Data type	Flags	Default
1C00:0	Sync manager type	Using the Sync Managers	UINT8	RO	0x04 (4 <sub>dec</sub> )
1C00:01	SubIndex 001	Sync-Manager Type Channel 1: Mailbox Write	UINT8	RO	0x01 (1 <sub>dec</sub> )
1C00:02	SubIndex 002	Sync-Manager Type Channel 2: Mailbox Read	UINT8	RO	0x02 (2 <sub>dec</sub> )
1C00:03	SubIndex 003	Sync-Manager Type Channel 3: Process Data Write(Outputs)	UINT8	RO	0x03 (3 <sub>dec</sub> )
1C00:04	SubIndex 004	Sync-Manager Type Channel 4: Process Data Read (Inputs)	UINT8	RO	0x04 (4 <sub>dec</sub> )

**Index 1C12 RxPDO assign**

Index (hex)	Name	Meaning	Data type	Flags	Default
1C12:0	RxPDO assign	PDO Assign Outputs	UINT8	RW	0x01 (1 <sub>dec</sub> )
1C12:01	SubIndex 001	1. allocated RxPDO (contains the index of the associated RxPDO mapping object)	UINT16	RW	0x1600 (5632 <sub>dec</sub> )

**Index 1C13 TxPDO assign**

Index (hex)	Name	Meaning	Data type	Flags	Default
1C13:0	TxPDO assign	PDO Assign Inputs	UINT8	RW	0x01 (1 <sub>dec</sub> )
1C13:01	SubIndex 001	1. allocated TxPDO (contains the index of the associated TxPDO mapping object)	UINT16	RW	0x1A00 (6656 <sub>dec</sub> )
1C13:02	SubIndex 002	2. allocated TxPDO (contains the index of the associated TxPDO mapping object)	UINT16	RW	0x0000 (0 <sub>dec</sub> )
1C13:03	SubIndex 003	3. allocated TxPDO (contains the index of the associated TxPDO mapping object)	UINT16	RW	0x0000 (0 <sub>dec</sub> )

## Index 1C32 SM output parameter

Index (hex)	Name	Meaning	Data type	Flags	Default
1C32:0	SM output parameter	Synchronization parameters for the outputs	UINT8	RO	0x20 (32 <sub>dec</sub> )
1C32:01	Sync mode	Current synchronization mode: <ul style="list-style-type: none"> <li>0: Free Run</li> <li>1: Synchron with SM 2 Event</li> <li>2: DC-Mode - Synchron with SYNC0 Event</li> <li>3: DC-Mode - Synchron with SYNC1 Event</li> </ul>	UINT16	RW	0x0001 (1 <sub>dec</sub> )
1C32:02	Cycle time	Cycle time (in ns): <ul style="list-style-type: none"> <li>Free Run: Cycle time of the local timer</li> <li>Synchron with SM 2 Event: Master cycle time</li> <li>DC mode: SYNC0/SYNC1 Cycle Time</li> </ul>	UINT32	RW	0x00000000 (0 <sub>dec</sub> )
1C32:03	Shift time	Time between SYNC0 event and output of the outputs (in ns, DC mode only)	UINT32	RO	0x00000000 (0 <sub>dec</sub> )
1C32:04	Sync modes supported	Supported synchronization modes: <ul style="list-style-type: none"> <li>Bit 0 = 1: free run is supported</li> <li>Bit 1 = 1: Synchron with SM 2 Event is supported</li> <li>Bit 2-3 = 01: DC mode is supported</li> <li>Bit 4-5 = 10: Output shift with SYNC1 event (only DC mode)</li> <li>Bit 14 = 1: dynamic times (measurement through writing of 0x1C32:08)</li> </ul>	UINT16	RO	0xC007 (49159 <sub>dec</sub> )
1C32:05	Minimum cycle time	Minimum cycle time (in ns)	UINT32	RO	0x00000000 (0 <sub>dec</sub> )
1C32:06	Calc and copy time	Minimum time between SYNC0 and SYNC1 event (in ns, DC mode only)	UINT32	RO	0x00000000 (0 <sub>dec</sub> )
1C32:07	Minimum delay time		UINT32	RO	0x00000000 (0 <sub>dec</sub> )
1C32:08	Command	With this entry the real required process data provision time can be measured. <ul style="list-style-type: none"> <li>0: Measurement of the local cycle time is stopped</li> <li>1: Measurement of the local cycle time is started</li> </ul> <p>The entries 0x1C32:03, 0x1C32:05, 0x1C32:06, 0x1C32:09, 0x1C33:03, 0x1C33:06, 0x1C33:09 are updated with the maximum measured values. For a subsequent measurement the measured values are reset</p>	UINT16	RW	0x0000 (0 <sub>dec</sub> )
1C32:09	Maximum delay time	Time between SYNC1 event and output of the outputs (in ns, DC mode only)	UINT32	RO	0x00000000 (0 <sub>dec</sub> )
1C32:0B	SM event missed counter	Number of missed SM events in OPERATIONAL (DC mode only)	UINT16	RO	0x0000 (0 <sub>dec</sub> )
1C32:0C	Cycle exceeded counter	Number of occasions the cycle time was exceeded in OPERATIONAL (cycle was not completed in time or the next cycle began too early)	UINT16	RO	0x0000 (0 <sub>dec</sub> )
1C32:0D	Shift too short counter	Number of occasions that the interval between SYNC0 and SYNC1 event was too short (DC mode only)	UINT16	RO	0x0000 (0 <sub>dec</sub> )
1C32:20	Sync error	The synchronization was not correct in the last cycle (outputs were output too late; DC mode only)	BOOLEAN	RO	0x00 (0 <sub>dec</sub> )

**Index 1C33 SM input parameter**

Index (hex)	Name	Meaning	Data type	Flags	Default
1C33:0	SM input parameter	Synchronization parameters for the inputs	UINT8	RO	0x20 (32 <sub>dec</sub> )
1C33:01	Sync mode	Current synchronization mode: <ul style="list-style-type: none"> <li>• 0: Free Run</li> <li>• 1: Synchron with SM 3 Event (no outputs available)</li> <li>• 2: DC - Synchron with SYNC0 Event</li> <li>• 3: DC - Synchron with SYNC1 Event</li> <li>• 34: Synchron with SM 2 Event (outputs available)</li> </ul>	UINT16	RW	0x0022 (34 <sub>dec</sub> )
1C33:02	Cycle time	as 0x1C32:02	UINT32	RW	0x00000000 (0 <sub>dec</sub> )
1C33:03	Shift time	Time between SYNC0 event and reading of the inputs (in ns, only DC mode)	UINT32	RO	0x00000000 (0 <sub>dec</sub> )
1C33:04	Sync modes supported	Supported synchronization modes: <ul style="list-style-type: none"> <li>• Bit 0: free run is supported</li> <li>• Bit 1: Synchron with SM 2 Event is supported (outputs available)</li> <li>• Bit 1: Synchron with SM 3 Event is supported (no outputs available)</li> <li>• Bit 2-3 = 01: DC mode is supported</li> <li>• Bit 4-5 = 01: Input shift through local event (outputs available)</li> <li>• Bit 4-5 = 10: Input shift with SYNC1 event (no outputs available)</li> <li>• Bit 14 = 1: dynamic times (measurement through writing of 0x1C32:08 or 0x1C33:08)</li> </ul>	UINT16	RO	0xC007 (49159 <sub>dec</sub> )
1C33:05	Minimum cycle time	as 0x1C32:05	UINT32	RO	0x00000000 (0 <sub>dec</sub> )
1C33:06	Calc and copy time	Time between reading of the inputs and availability of the inputs for the master (in ns, only DC mode)	UINT32	RO	0x00000000 (0 <sub>dec</sub> )
1C33:07	Minimum delay time		UINT32	RO	0x00000000 (0 <sub>dec</sub> )
1C33:08	Command	as 0x1C32:08	UINT16	RW	0x0000 (0 <sub>dec</sub> )
1C33:09	Maximum delay time	Time between SYNC1 event and reading of the inputs (in ns, only DC mode)	UINT32	RO	0x00000000 (0 <sub>dec</sub> )
1C33:0B	SM event missed counter	as 0x1C32:11	UINT16	RO	0x0000 (0 <sub>dec</sub> )
1C33:0C	Cycle exceeded counter	as 0x1C32:12	UINT16	RO	0x0000 (0 <sub>dec</sub> )
1C33:0D	Shift too short counter	as 0x1C32:13	UINT16	RO	0x0000 (0 <sub>dec</sub> )
1C33:20	Sync error	as 0x1C32:32	BOOLEAN	RO	0x00 (0 <sub>dec</sub> )

**Index F000 Modular device profile**

Index (hex)	Name	Meaning	Data type	Flags	Default
F000:0	Modular device profile	General information for the modular device profile	UINT8	RO	0x02 (2 <sub>dec</sub> )
F000:01	Module index distance	Index distance of the objects of the individual channels	UINT16	RO	0x0010 (16 <sub>dec</sub> )
F000:02	Maximum number of modules	Number of channels	UINT16	RO	0x0001 (1 <sub>dec</sub> )

**Index F008 Code word**

Index (hex)	Name	Meaning	Data type	Flags	Default
F008:0	Code word	reserved	UINT32	RW	0x00000000 (0 <sub>dec</sub> )

**Index F010 Module list**

Index (hex)	Name	Meaning	Data type	Flags	Default
F010:0	Module list	Maximum subindex	UINT8	RW	0x02 (2 <sub>dec</sub> )
F010:01	SubIndex 001	reserved	UINT32	RW	0x000001FE (510 <sub>dec</sub> )



## 6.3 EP5101-0011

### ● Parameterization



You can parameterize the box via the "CoE - Online" tab in TwinCAT.

### ● EtherCAT XML Device Description



The presentation matches that of the EtherCAT XML Device Description.

Recommendation: download the latest XML file from <https://www.beckhoff.com/> and install it according to the installation instructions.

### 6.3.1 Restore object

#### Index 1011 Restore default parameters

Index (hex)	Name	Meaning	Data type	Flags	Default
1011:0	Restore default parameters	Restore the default settings	UINT8	RO	0x01 (1 <sub>dec</sub> )
1011:01	SubIndex 001	If this object is set to " <b>0x64616F6C</b> " in the set value dialog, all backup objects are reset to their delivery state. Note: Some FW versions also accept the following input: <b>0x6C6F6164</b> ".	UINT32	RW	0x00000000 (0 <sub>dec</sub> )

## 6.3.2 Configuration data

### Index 8000 ENC Settings

Index (hex)	Name	Meaning	Data type	Flags	Default
8000:0	ENC Settings	Maximum subindex	UINT8	RO	0x17 (23 <sub>dec</sub> )
8000:01	Enable C reset <a href="#">▶ 69</a>	The counter is reset via the C input.	BOOLEAN	RW	0x00 (0 <sub>dec</sub> )
8000:02	Enable extern reset <a href="#">▶ 69</a>	A counter reset is triggered via the external latch input (24 V).	BOOLEAN	RW	0x00 (0 <sub>dec</sub> )
8000:03	Enable up/down counter <a href="#">▶ 69</a>	Enablement of the up/down counter in place of the encoder with the bit set. Increments are counted at input A. Input B specifies the counting direction.	BOOLEAN	RW	0x00 (0 <sub>dec</sub> )
8000:04	Gate polarity <a href="#">▶ 69</a>	0: Disable gate 1: Enable pos. gate (gate locks with HIGH signal level) 2: Enable neg. gate (gate locks with LOW signal level)	BIT2	RW	0x01 (1 <sub>dec</sub> )
8000:08	Disable filter	0: Activates the input filter (inputs A, /A, B, /B, C, /C only) 1: Deactivates the input filter If a filter is activated a signal edge must be present for at least 2.4 μs in order to be counted as an increment.	BOOLEAN	RW	0x01 (1 <sub>dec</sub> )
8000:0A	Enable micro increments <a href="#">▶ 70</a>	If DC mode is activated, the Box interpolates micro-increments between the integer encoder increments. The lower 8 bits of the <i>Counter Value</i> are used in each case for the display. A 32-bit counter thus becomes a 24+8-bit counter, a 16-bit counter becomes an 8+8-bit counter.	BOOLEAN	RW	0x00 (0 <sub>dec</sub> )
8000:0B	Open circuit detection A <a href="#">▶ 70</a>	An open circuit on track A is indicated in object <i>Open circuit</i> (index 0x6000:07 <a href="#">▶ 100</a> ) and as a process data. Diagnosis is only possible if the corresponding input is wired differentially. A differential voltage < 3.5 V (typical, subject to change) is detected as a broken wire.	BOOLEAN	RW	0x01 (1 <sub>dec</sub> )
8000:0C	Open circuit detection B <a href="#">▶ 70</a>	An open circuit on track B is indicated in object <i>Open circuit</i> (index 0x6000:07 <a href="#">▶ 100</a> ) and as a process data. Diagnosis is only possible if the corresponding input is wired differentially. A differential voltage < 3.5 V (typical, subject to change) is detected as a broken wire.	BOOLEAN	RW	0x01 (1 <sub>dec</sub> )
8000:0D	Open circuit detection C <a href="#">▶ 70</a>	An open circuit on track C is indicated in object <i>Open circuit</i> (index 0x6000:07 <a href="#">▶ 100</a> ) and as a process data. Diagnosis is only possible if the corresponding input is wired differentially. A differential voltage < 3.5 V (typical, subject to change) is detected as a broken wire.	BOOLEAN	RW	0x00 (0 <sub>dec</sub> )
8000:0E	Reversion of rotation <a href="#">▶ 69</a>	Activates reversion of rotation	BOOLEAN	RW	0x00 (0 <sub>dec</sub> )
8000:10	Extern reset polarity <a href="#">▶ 69</a>	0: Fall (the counter is set to zero with a falling edge) 1: Rise (the counter is set to zero with a rising edge)	BIT2	RW	0x01 (1 <sub>dec</sub> )
8000:11	Frequency window <a href="#">▶ 68</a>	This is the minimum time over which the frequency is determined; default value 10 ms [resolution: 1 μs]. The number of pulses in the timeframe + the following is measured. The maximum waiting time is specified in the <i>Frequency Wait Time</i> parameter. The number of pulses is divided by the actual time window size. The determined frequency is output in object <i>Frequency value</i> (index 0x6000:13 <a href="#">▶ 100</a> ) and as a process data. The frequency calculation is carried out locally without distributed clocks function.	UINT16	RW	0x2710 (10000 <sub>dec</sub> )
8000:13	Frequency scaling <a href="#">▶ 68</a>	Scaling of the frequency measurement (must be divided by this value to obtain the unit in Hz): 100: "0.01 Hz"	UINT16	RW	0x0064 (100 <sub>dec</sub> )
8000:14	Period scaling <a href="#">▶ 68</a>	Resolution of the period value in the process data: 100: "100 ns" period value is a multiple of 100 ns 500: "500 ns" period value is a multiple of 500 ns	UINT16	RW	0x0064 (100 <sub>dec</sub> )
8000:15	Frequency resolution <a href="#">▶ 68</a>	Resolution of the frequency measurement: 100: "0.01 Hz"	UINT16	RW	0x0064 (100 <sub>dec</sub> )

Index (hex)	Name	Meaning	Data type	Flags	Default
8000:16	<a href="#">Period resolution</a> <a href="#">▶ 68</a>	<p>Internal resolution of the period value measurement: 100: “100 ns” period value is a multiple of 100 ns</p> <p>The period is calculated internally with a resolution of 100 ns. The max. measurable period can then be approx. 1.6 seconds.</p> <p>500: “500 ns” period value is a multiple of 500 ns</p> <p>Internally the period is calculated with 500 ns resolution. The maximum measurable period is approx. 32.7 ms. The resolution of the process data continues to be the value according to object <i>Period scaling</i> (index 0x8000:14) (e.g., 100 ns [default]).</p>	UINT16	RW	0x0064 (100 <sub>dec</sub> )
8000:17	<a href="#">Frequency wait time</a> <a href="#">▶ 68</a>	<p>Waiting time [ms] for frequency measurement</p> <p>Once the time specified in the <i>frequency window</i> has elapsed, the system waits for the next positive edge from track A. This enables the update speed for the <i>Frequency</i> process data to be optimized, depending on the expected frequencies. The minimum value to be entered here is twice the period value of the smallest measured frequency.</p> <p><math>T \geq 2 * (1 / f_{min})</math></p>	UINT16	RW	0x0640 (1600 <sub>dec</sub> )

### 6.3.3 Input data

#### Index 6000 ENC Inputs

Index (hex)	Name	Meaning	Data type	Flags	Default
6000:0	ENC Inputs	Maximum subindex	UINT8	RO	0x16 (22 <sub>dec</sub> )
6000:01	<a href="#">Latch C valid</a> [ <a href="#">▶ 69</a> ]	The counter value was latched with the “C” input. The data with <i>Latch Value</i> (Index 0x6000:12) corresponds to the latched value if the bit is set. To re-enable the latch input, <i>Enable latch C</i> (index 0x7000:01 [ <a href="#">▶ 101</a> ]) must be canceled and then reset.	BOOLEAN	RO	0x00 (0 <sub>dec</sub> )
6000:02	<a href="#">Latch extern valid</a> [ <a href="#">▶ 69</a> ]	The counter value was locked via the external latch. The data with <i>Latch Value</i> (Index 0x6000:12) corresponds to the latched value if the bit is set. To re-enable the latch input, <i>Enable latch extern on positive edge</i> (index 0x7000:02 [ <a href="#">▶ 101</a> ]) or object <i>Enable latch extern on negative edge</i> (index 0x7000:04 [ <a href="#">▶ 101</a> ]) must first be canceled and then reset.	BOOLEAN	RO	0x00 (0 <sub>dec</sub> )
6000:03	Set counter done	The counter was set.	BOOLEAN	RO	0x00 (0 <sub>dec</sub> )
6000:04	<a href="#">Counter underflow</a> [ <a href="#">▶ 70</a> ]	The counter has passed the zero crossing backwards. Overflow/underflow control is inactive in combination with a reset function (C/external).	BOOLEAN	RO	0x00 (0 <sub>dec</sub> )
6000:05	<a href="#">Counter overflow</a> [ <a href="#">▶ 70</a> ]	Counter overflow. Overflow/underflow control is inactive in combination with a reset function (C/external).	BOOLEAN	RO	0x00 (0 <sub>dec</sub> )
6000:06	Status of input status	State of the status input (alarm “input 1”)	BOOLEAN	RO	0x00 (0 <sub>dec</sub> )
6000:07	<a href="#">Open circuit</a> [ <a href="#">▶ 70</a> ]	Indicates an open circuit. Configuration via the objects: <i>Open circuit detection A</i> Index Index0x8000:0B [ <a href="#">▶ 98</a> ], <i>Open circuit detection B</i> Index Index0x8000:0C, [ <a href="#">▶ 98</a> ] <i>Open circuit detection C</i> Index Index0x8000:0D [ <a href="#">▶ 98</a> ]	BOOLEAN	RO	0x00 (0 <sub>dec</sub> )
6000:08	<a href="#">Extrapolation stall</a> [ <a href="#">▶ 70</a> ]	The extrapolated part of the counter is invalid.	BOOLEAN	RO	0x00 (0 <sub>dec</sub> )
6000:09	Status of input A	Status of input A	BOOLEAN	RO	0x00 (0 <sub>dec</sub> )
6000:0A	Status of input B	Status of input B	BOOLEAN	RO	0x00 (0 <sub>dec</sub> )
6000:0B	Status of input C	Status of input C	BOOLEAN	RO	0x00 (0 <sub>dec</sub> )
6000:0C	Status of input gate	The state of the gate input	BOOLEAN	RO	0x00 (0 <sub>dec</sub> )
6000:0D	Status of external ledge	Status of the extern latch input	BOOLEAN	RO	0x00 (0 <sub>dec</sub> )
6000:0E	Sync error	The Sync error bit is only required for DC mode. It indicates whether a synchronization error has occurred during the previous cycle. This means a SYNC signal was triggered in the Box, although no new process data were available (0=OK, 1=NOK).	BOOLEAN	RO	0x00 (0 <sub>dec</sub> )
6000:0F	TxPDO State	Validity of the data of the associated TxPDO (0 = valid, 1 = invalid).	BOOLEAN	RO	0x00 (0 <sub>dec</sub> )
6000:10	TxPDO Toggle	The TxPDO toggle is toggled by the slave when the data of the associated TxPDO is updated.	BOOLEAN	RO	0x00 (0 <sub>dec</sub> )
6000:11	Counter value	Counter value	UINT32	RO	0x00000000 (0 <sub>dec</sub> )
6000:12	Latch value	Latch value	UINT32	RO	0x00000000 (0 <sub>dec</sub> )
6000:13	<a href="#">Frequency value</a> [ <a href="#">▶ 68</a> ]	The frequency (setting of the scaling in index 0x8000:13 [ <a href="#">▶ 98</a> ] and resolution in index 0x8000:15 [ <a href="#">▶ 98</a> ])	UINT32	RO	0x00000000 (0 <sub>dec</sub> )
6000:14	<a href="#">Period value</a> [ <a href="#">▶ 68</a> ]	The period value (setting of the scaling in index 0x8000:14 [ <a href="#">▶ 98</a> ] and resolution in index 0x8000:16 [ <a href="#">▶ 98</a> ])	UINT32	RO	0x00000000 (0 <sub>dec</sub> )
6000:16	<a href="#">Timestamp</a> [ <a href="#">▶ 56</a> ]	Timestamp of the last counter change	UINT64	RO	

### 6.3.4 Output data

#### Index 7000 ENC Outputs

Index (hex)	Name	Meaning	Data type	Flags	Default
7000:0	ENC Outputs	Maximum subindex	UINT8	RO	0x11(17 <sub>dec</sub> )
7000:01	<a href="#">Enable latch C [▶ 69]</a>	Activate latching via input "C".	BOOLEAN	RO	0x00 (0 <sub>dec</sub> )
7000:01	<a href="#">Enable latch extern on positive edge [▶ 69]</a>	Activate external latch with positive edge.	BOOLEAN	RO	0x00 (0 <sub>dec</sub> )
7000:03	Set counter	Set counter value	BOOLEAN	RO	0x00 (0 <sub>dec</sub> )
7000:04	<a href="#">Enable latch extern on negative edge [▶ 69]</a>	Activate external latch with negative edge.	BOOLEAN	RO	0x00 (0 <sub>dec</sub> )
7000:11	Set counter value	The counter value to be set via <i>Set counter</i> (index 0x7000:03).	UINT32	RO	0x00000000 (dec)

### 6.3.5 Information / diagnostic data (channel specific)

#### Index A000 ENC Diag data

Index (hex)	Name	Meaning	Data type	Flags	Default
A000:0	ENC Diag data	Maximum subindex	UINT8	RO	0x03 (3 <sub>dec</sub> )
A000:01	<a href="#">Open circuit A [▶ 70]</a>	Open circuit on track A	BOOLEAN	RO	0x00 (0 <sub>dec</sub> )
A000:02	<a href="#">Open circuit B [▶ 70]</a>	Open circuit on track B	BOOLEAN	RO	0x00 (0 <sub>dec</sub> )
A000:03	<a href="#">Open circuit C [▶ 70]</a>	Open circuit on track C	BOOLEAN	RO	0x00 (0 <sub>dec</sub> )

### 6.3.6 Standard objects

The standard objects have the same meaning for all EtherCAT slaves.

#### Index 1000 Device type

Index (hex)	Name	Meaning	Data type	Flags	Default
1000:0	Device type	Device type of the EtherCAT slave: The Lo-Word contains the CoE profile used (5001). The Hi-Word contains the module profile according to the modular device profile.	UINT32	RO	0x01FF1389 (33493897 <sub>dec</sub> )

#### Index 1008 Device name

Index (hex)	Name	Meaning	Data type	Flags	Default
1008:0	Device name	Device name of the EtherCAT slave	STRING	RO	EP5101-0011

#### Index 1009 Hardware version

Index (hex)	Name	Meaning	Data type	Flags	Default
1009:0	Hardware version	Hardware version of the EtherCAT slave	STRING	RO	-

#### Index 100A Software version

Index (hex)	Name	Meaning	Data type	Flags	Default
100A:0	Software version	Firmware version of the EtherCAT slave	STRING	RO	-

**Index 1018 Identity**

Index (hex)	Name	Meaning	Data type	Flags	Default
1018:0	Identity	Information for identifying the slave	UINT8	RO	0x04 (4 <sub>dec</sub> )
1018:01	Vendor ID	Vendor ID of the EtherCAT slave	UINT32	RO	0x00000002 (2 <sub>dec</sub> )
1018:02	Product code	Product code of the EtherCAT slave	UINT32	RO	0x13ED4052 (334315602 <sub>dec</sub> )
1018:03	Revision	Revision number of the EtherCAT slave; the Low Word (bit 0-15) indicates the special terminal number, the High Word (bit 16-31) refers to the device description	UINT32	RO	0x00000000 (0 <sub>dec</sub> )
1018:04	Serial number	Serial number of the EtherCAT slave; the Low Byte (bit 0-7) of the Low Word contains the year of production, the High Byte (bit 8-15) of the Low Word contains the week of production, the High Word (bit 16-31) is 0	UINT32	RO	0x00000000 (0 <sub>dec</sub> )

**Index 10F0 Backup parameter handling**

Index (hex)	Name	Meaning	Data type	Flags	Default
10F0:0	Backup parameter handling	Information for standardized loading and saving of backup entries	UINT8	RO	0x01 (1 <sub>dec</sub> )
10F0:01	Checksum	Checksum across all backup entries of the EtherCAT slave	UINT32	RO	0x00000000 (0 <sub>dec</sub> )

**Index 1400 ENC RxPDO-Par Control compact**

Index (hex)	Name	Meaning	Data type	Flags	Default
1400:0	ENC RxPDO-Par Control compact	PDO Parameter RxPDO 1	UINT8	RO	0x06 (6 <sub>dec</sub> )
1400:06	Exclude RxPDOs	Specifies the RxPDOs (index of RxPDO mapping objects) that must not be transferred together with RxPDO 1	OCTET-STRING[2]	RO	01 16

**Index 1401 ENC RxPDO-Par Control**

Index (hex)	Name	Meaning	Data type	Flags	Default
1401:0	ENC RxPDO-Par Control	PDO Parameter RxPDO 2	UINT8	RO	0x06 (6 <sub>dec</sub> )
1401:06	Exclude RxPDOs	Specifies the RxPDOs (index of RxPDO mapping objects) that must not be transferred together with RxPDO 2	OCTET-STRING[2]	RO	00 16

**Index 1600 ENC RxPDO-Map Control compact**

Index (hex)	Name	Meaning	Data type	Flags	Default
1600:0	ENC RxPDO-Map Control compact	PDO Mapping RxPDO 3	UINT8	RO	0x07 (7 <sub>dec</sub> )
1600:01	SubIndex 001	1. PDO Mapping entry (object 0x7000 (ENC Outputs), entry 0x01 (Enable latch C))	UINT32	RO	0x7000:01, 1
1600:02	SubIndex 002	2. PDO Mapping entry (object 0x7000 (ENC Outputs), entry 0x02 (Enable latch extern on positive edge))	UINT32	RO	0x7000:02, 1
1600:03	SubIndex 003	3. PDO Mapping entry (object 0x7000 (ENC Outputs), entry 0x03 (Set counter))	UINT32	RO	0x7000:03, 1
1600:04	SubIndex 004	4. PDO Mapping entry (object 0x7000 (ENC Outputs), entry 0x04 (Enable latch extern on negative edge))	UINT32	RO	0x7000:04, 1
1600:05	SubIndex 005	5. PDO Mapping entry (4 bits align)	UINT32	RO	0x0000:00, 4
1600:06	SubIndex 006	6. PDO Mapping entry (8 bits align)	UINT32	RO	0x0000:00, 8
1600:07	SubIndex 007	7. PDO Mapping entry (object 0x7000 (ENC Outputs), entry 0x11 (Set counter value))	UINT32	RO	0x7000:11, 16

**Index 1601 ENC RxPDO-Map Control**

Index (hex)	Name	Meaning	Data type	Flags	Default
1601:0	ENC RxPDO-Map Control compact	PDO Mapping RxPDO	UINT8	RO	0x07 (7 <sub>dec</sub> )
1601:01	SubIndex 001	1. PDO Mapping entry (object 0x7000 (ENC Outputs), entry 0x01 (Enable latch C))	UINT32	RO	0x7000:01,1
1601:02	SubIndex 002	2. PDO Mapping entry (object 0x7000 (ENC Outputs), entry 0x02 (Enable latch extern on positive edge))	UINT32	RO	0x7000:02,1
1601:03	SubIndex 003	3. PDO Mapping entry (object 0x7000 (ENC Outputs), entry 0x03 (Set counter))	UINT32	RO	0x7000:03,1
1601:04	SubIndex 004	4. PDO Mapping entry (object 0x7000 (ENC Outputs), entry 0x04 (Enable latch extern on negative edge))	UINT32	RO	0x7000:04,1
1601:05	SubIndex 005	5. PDO Mapping entry (4 bits align)	UINT32	RO	0x0000:00,4
1601:06	SubIndex 006	6. PDO Mapping entry (8 bits align)	UINT32	RO	0x0000:00,8
1601:07	SubIndex 007	7. PDO Mapping entry (object 0x7000 (ENC Outputs), entry 0x11 (Set counter value))	UINT32	RO	0x7000:11,32

**Index 1800 ENC TxPDO-Par Status compact**

Index (hex)	Name	Meaning	Data type	Flags	Default
1800:0	ENC TxPDO-Par Status	PDO parameter TxPDO 1	UINT8	RO	0x09 (9 <sub>dec</sub> )
1800:06	Exclude TxPDOs	Specifies the TxPDOs (index of TxPDO mapping objects) that must not be transferred together with TxPDO 1	OCTET-STRING[2]	RO	01 1A
1800:07	TxPDO State	The TxPDO state is set if it was not possible to correctly read in the associated input data	BOOLEAN	RO	0x00 (0 <sub>dec</sub> )
1800:09	TxPDO Toggle	The TxPDO toggle is toggled with each update the corresponding input data	BOOLEAN	RO	0x00 (0 <sub>dec</sub> )

**Index 1801 ENC TxPDO-Par Status**

Index (hex)	Name	Meaning	Data type	Flags	Default
1801:0	ENC TxPDO-Par Status compact	PDO parameter TxPDO 2	UINT8	RO	0x09 (9 <sub>dec</sub> )
1801:06	Exclude TxPDOs	Specifies the TxPDOs (index of TxPDO mapping objects) that must not be transferred together with TxPDO 2	OCTET-STRING[2]	RO	00 1A
1801:07	TxPDO State	The TxPDO state is set if it was not possible to correctly read in the associated input data	BOOLEAN	RO	0x00 (0 <sub>dec</sub> )
1801:09	TxPDO Toggle	The TxPDO toggle is toggled with each update the corresponding input data	BOOLEAN	RO	0x00 (0 <sub>dec</sub> )

**Index 1802 ENC TxPDO-Par Frequency**

Index (hex)	Name	Meaning	Data type	Flags	Default
1802:0	ENC TxPDO-Par Frequency	PDO parameter TxPDO 3	UINT8	RO	0x06 (6 <sub>dec</sub> )
1802:06	Exclude TxPDOs	Specifies the TxPDOs (index of TxPDO mapping objects) that must not be transferred together with TxPDO 3	OCTET-STRING[2]	RO	03 1A

**Index 1803 ENC TxPDO-Par Period**

Index (hex)	Name	Meaning	Data type	Flags	Default
1803:0	ENC TxPDO-Par Period	PDO parameter TxPDO 4	UINT8	RO	0x06 (6 <sub>dec</sub> )
1803:06	Exclude TxPDOs	Specifies the TxPDOs (index of TxPDO mapping objects) that must not be transferred together with TxPDO 4	OCTET-STRING[2]	RO	02 1A

**Index 1804 ENC TxPDO-Par Timest.**

Index (hex)	Name	Meaning	Data type	Flags	Default
1804:0	ENC TxPDO-Par Timest.	PDO parameter TxPDO 5	UINT8	RO	0x06 (6 <sub>dec</sub> )
1804:06	Exclude TxPDOs	Specifies the TxPDOs (index of TxPDO mapping objects) that must not be transferred together with TxPDO 5	OCTET-STRING[2]	RO	05 1A

**Index 1805 ENC TxPDO-Par Timest. compact**

Index (hex)	Name	Meaning	Data type	Flags	Default
1805:0	ENC TxPDO-Par Timest. compact	PDO parameter TxPDO 6	UINT8	RO	0x06 (6 <sub>dec</sub> )
1805:06	Exclude TxPDOs	Specifies the TxPDOs (index of TxPDO mapping objects) that must not be transferred together with TxPDO 6	OCTET-STRING[2]	RO	04 1A

**Index 1A00 ENC TxPDO-Map Status compact**

Index (hex)	Name	Meaning	Data type	Flags	Default
1A00:0	ENC TxPDO-Map Status	ENC TxPDO-Map Status compact	UINT8	RO	0x012 (18 <sub>dec</sub> )
1A00:01	SubIndex 001	1. PDO Mapping entry (object 0x6000 (ENC Inputs), entry 0x01 (Latch C valid))	UINT32	RO	0x6000:01, 1
1A00:02	SubIndex 002	2. PDO Mapping entry (object 0x6000 (ENC Inputs), entry 0x02 (Latch extern valid))	UINT32	RO	0x6000:02, 1
1A00:03	SubIndex 003	3. PDO Mapping entry (object 0x6000 (ENC Inputs), entry 0x03 (Set counter done))	UINT32	RO	0x6000:03, 1
1A00:04	SubIndex 004	4. PDO Mapping entry (object 0x6000 (ENC Inputs), entry 0x04 (Counter underflow))	UINT32	RO	0x6000:04, 1
1A00:05	SubIndex 005	5. PDO Mapping entry (object 0x6000 (ENC Inputs), entry 0x05 (Counter overflow))	UINT32	RO	0x6000:05, 1
1A00:06	SubIndex 006	6. PDO Mapping entry (object 0x6000 (ENC Inputs), entry 0x06 (Status of input status))	UINT32	RO	0x6000:06, 1
1A00:07	SubIndex 007	7. PDO Mapping entry (object 0x6000 (ENC Inputs), entry 0x07 (Open circuit))	UINT32	RO	0x6000:07, 1
1A00:08	SubIndex 008	8. PDO Mapping entry (object 0x6000 (ENC Inputs), entry 0x08 (Extrapolation stall))	UINT32	RO	0x6000:08, 1
1A00:09	SubIndex 009	9. PDO Mapping entry (object 0x6000 (ENC Inputs), entry 0x09 (Status of input A))	UINT32	RO	0x6000:09, 1
1A00:0A	SubIndex 010	10. PDO Mapping entry (object 0x6000 (ENC Inputs), entry 0x0A (Status of input B))	UINT32	RO	0x6000:0A, 1
1A00:0B	SubIndex 011	11. PDO Mapping entry (object 0x6000 (ENC Inputs), entry 0x0B (Status of input C))	UINT32	RO	0x6000:0B, 1
1A00:0C	SubIndex 012	12. PDO Mapping entry (object 0x6000 (ENC Inputs), entry 0x0C (Status of input gate))	UINT32	RO	0x6000:0C; 2
1A00:0D	SubIndex 013	13. PDO Mapping entry (object 0x6000 (ENC Inputs), entry 0x0D (Status of extern latch))	UINT32	RO	0x6000:0D; 2
1A00:0E	SubIndex 014	14. PDO Mapping entry (object 0x1C32 (SM output parameter), entry 0x20 (Sync error))	UINT32	RO	0x1C32:20, 1
1A00:0F	SubIndex 015	15. PDO Mapping entry (object 0x1800 (ENC TxPDO-Par Status compact), entry 0x07 (TxPDO State))	UINT32	RO	0x1800:07, 1
1A00:10	SubIndex 016	16. PDO Mapping entry (object 0x1800 (ENC TxPDO-Par Status compact), entry 0x09 (TxPDO Toggle))	UINT32	RO	0x1800:09, 1
1A00:11	SubIndex 017	17. PDO Mapping entry (object 0x6000 (ENC Inputs), entry 0x11 (Counter value))	UINT32	RO	0x6000:11, 16
1A00:12	SubIndex 018	17. PDO Mapping entry (object 0x6000 (ENC Inputs), entry 0x12 (Latch value))	UINT32	RO	0x6000:12, 16



**Index 1A01 ENC TxPDO-Map Status**

Index (hex)	Name	Meaning	Data type	Flags	Default
1A01:0	ENC TxPDO-Map Status compact	PDO Mapping TxPDO 2	UINT8	RO	0x12 (18 <sub>dec</sub> )
1A01:01	SubIndex 001	1. PDO Mapping entry (object 0x6000 (ENC Inputs), entry 0x01 (Latch C valid))	UINT32	RO	0x6000:01, 1
1A01:02	SubIndex 002	2. PDO Mapping entry (object 0x6000 (ENC Inputs), entry 0x02 (Latch extern valid))	UINT32	RO	0x6000:02, 1
1A01:03	SubIndex 003	3. PDO Mapping entry (object 0x6000 (ENC Inputs), entry 0x03 (Set counter done))	UINT32	RO	0x6000:03, 1
1A01:04	SubIndex 004	4. PDO Mapping entry (object 0x6000 (ENC Inputs), entry 0x04 (Counter underflow))	UINT32	RO	0x6000:04, 1
1A01:05	SubIndex 005	5. PDO Mapping entry (object 0x6000 (ENC Inputs), entry 0x05 (Counter overflow))	UINT32	RO	0x6000:05, 1
1A01:06	SubIndex 006	6. PDO Mapping entry (object 0x6000 (ENC Inputs), entry 0x06 (Status of input status))	UINT32	RO	0x6000:06, 1
1A01:07	SubIndex 007	7. PDO Mapping entry (object 0x6000 (ENC Inputs), entry 0x07 (Open circuit))	UINT32	RO	0x6000:07, 1
1A01:08	SubIndex 008	8. PDO Mapping entry (object 0x6000 (ENC Inputs), entry 0x08 (Extrapolation stall))	UINT32	RO	0x6000:08, 1
1A01:09	SubIndex 009	9. PDO Mapping entry (object 0x6000 (ENC Inputs), entry 0x09 (Status of input A))	UINT32	RO	0x6000:09, 1
1A01:0A	SubIndex 010	10. PDO Mapping entry (object 0x6000 (ENC Inputs), entry 0x0A (Status of input B))	UINT32	RO	0x6000:0A, 1
1A01:0B	SubIndex 011	11. PDO Mapping entry (object 0x6000 (ENC Inputs), entry 0x0B (Status of input C))	UINT32	RO	0x6000:0B, 1
1A01:0C	SubIndex 012	12. PDO Mapping entry (object 0x6000 (ENC Inputs), entry 0x0C (Status of input gate))	UINT32	RO	0x6000:0C, 1
1A01:0D	SubIndex 013	13. PDO Mapping entry (object 0x6000 (ENC Inputs), entry 0x0D (Status of extern latch))	UINT32		0x6000:0D, 1
1A01:0E	SubIndex 014	14. PDO Mapping entry (object 0x1C32 (SM output parameter), entry 0x20 (Sync error))	UINT32	RO	0x1C32:20, 1
1A01:0F	SubIndex 015	15. PDO Mapping entry (object 0x1801 (ENC TxPDO-Par Status), entry 0x07 (TxPDO State))			0x1801:07, 1
1A01:10	SubIndex 016	16. PDO Mapping entry (object 0x1801 (ENC TxPDO-Par Status), entry 0x09 (TxPDO Toggle))	UINT32	RO	0x1801:09, 1
1A01:11	SubIndex 017	17. PDO Mapping entry (object 0x6000 (ENC Inputs), entry 0x11 (Counter value))	UINT32	RO	0x6000:11, 16
1A01:12	SubIndex 018	18. PDO Mapping entry (object 0x6000 (ENC Inputs), entry 0x12 (Latch value))	UINT32	RO	0x6000:12, 16

**Index 1A02 ENC TxPDO-Map Frequency**

Index (hex)	Name	Meaning	Data type	Flags	Default
1A02:0	TxPDO map frequency	PDO Mapping TxPDO	UINT8	RO	0x01 (1 <sub>dec</sub> )
1A02:01	SubIndex 001	1. PDO Mapping entry (object 0x6000 (Inputs), entry 0x13 (Frequency value))	UINT32	RO	0x6000:13, 32

**Index 1A03 ENC TxPDO-Map Period**

Index (hex)	Name	Meaning	Data type	Flags	Default
1A03:0	ENC TxPDO-Map Period	ENC TxPDO-Map Period	UINT8	RO	0x01 (1 <sub>dec</sub> )
1A03:01	SubIndex 001	1. PDO Mapping entry (object 0x6000 (ENC Inputs), entry 0x14 (Period value))	UINT32	RO	0x6000:14, 32

**Index 1A04 ENC TxPDO-Map Timest.**

Index (hex)	Name	Meaning	Data type	Flags	Default
1A04:0	ENC TxPDO-Map Timest. compact	PDO Mapping TxPDO	UINT8	RO	0x01 (1 <sub>dec</sub> )
1A04:01	SubIndex 001	1. PDO Mapping entry (object 0x6010 (ENC Inputs), entry 0x16 (Timestamp))	UINT32	RO	0x6000:16, 64

**Index 1A05 ENC TxPDO-Map Timest. compact**

Index (hex)	Name	Meaning	Data type	Flags	Default
1A05:0	ENC TxPDO-Map Timest. compact	PDO Mapping TxPDO	UINT8	RO	0x01 (1 <sub>dec</sub> )
1A05:01	SubIndex 001	1. PDO Mapping entry (object 0x6010 (ENC Inputs), entry 0x16 (Timestamp))	UINT32	RO	0x6000:16, 32

**Index 1C00 Sync manager type**

Index (hex)	Name	Meaning	Data type	Flags	Default
1C00:0	Sync manager type	Using the Sync Managers	UINT8	RO	0x04 (4 <sub>dec</sub> )
1C00:01	SubIndex 001	Sync-Manager Type Channel 1: Mailbox Write	UINT8	RO	0x01 (1 <sub>dec</sub> )
1C00:02	SubIndex 002	Sync-Manager Type Channel 2: Mailbox Read	UINT8	RO	0x02 (2 <sub>dec</sub> )
1C00:03	SubIndex 003	Sync-Manager Type Channel 3: Process Data Write(Outputs)	UINT8	RO	0x03 (3 <sub>dec</sub> )
1C00:04	SubIndex 004	Sync-Manager Type Channel 4: Process Data Read (Inputs)	UINT8	RO	0x04 (4 <sub>dec</sub> )

**Index 1C12 RxPDO assign**

Index (hex)	Name	Meaning	Data type	Flags	Default
1C12:0	RxPDO assign	PDO Assign Outputs	UINT8	RW	0x01 (1 <sub>dec</sub> )
1C12:01	SubIndex 001	1. allocated RxPDO (contains the index of the associated RxPDO mapping object)	UINT16	RW	0x1600 (5632 <sub>dec</sub> )

**Index 1C13 TxPDO assign**

Index (hex)	Name	Meaning	Data type	Flags	Default
1C13:0	TxPDO assign	PDO Assign Inputs	UINT8	RW	0x01 (1 <sub>dec</sub> )
1C13:01	SubIndex 001	1. allocated TxPDO (contains the index of the associated TxPDO mapping object)	UINT16	RW	0x1A00 (6656 <sub>dec</sub> )
1C13:02	SubIndex 002	2. allocated TxPDO (contains the index of the associated TxPDO mapping object)	UINT16	RW	0x0000 (0 <sub>dec</sub> )
1C13:03	SubIndex 003	3. allocated TxPDO (contains the index of the associated TxPDO mapping object)	UINT16	RW	0x0000 (0 <sub>dec</sub> )

**Index 1C32 SM output parameter**

Index (hex)	Name	Meaning	Data type	Flags	Default
1C32:0	SM output parameter	Synchronization parameters for the outputs	UINT8	RO	0x20 (32 <sub>dec</sub> )
1C32:01	Sync mode	Current synchronization mode: <ul style="list-style-type: none"> <li>0: Free Run</li> <li>1: Synchron with SM 2 Event</li> <li>2: DC-Mode - Synchron with SYNC0 Event</li> <li>3: DC-Mode - Synchron with SYNC1 Event</li> </ul>	UINT16	RW	0x0001 (1 <sub>dec</sub> )
1C32:02	Cycle time	Cycle time (in ns): <ul style="list-style-type: none"> <li>Free Run: Cycle time of the local timer</li> <li>Synchron with SM 2 Event: Master cycle time</li> <li>DC mode: SYNC0/SYNC1 Cycle Time</li> </ul>	UINT32	RW	0x00000000 (0 <sub>dec</sub> )
1C32:03	Shift time	Time between SYNC0 event and output of the outputs (in ns, DC mode only)	UINT32	RO	0x00000000 (0 <sub>dec</sub> )
1C32:04	Sync modes supported	Supported synchronization modes: <ul style="list-style-type: none"> <li>Bit 0 = 1: free run is supported</li> <li>Bit 1 = 1: Synchron with SM 2 Event is supported</li> <li>Bit 2-3 = 01: DC mode is supported</li> <li>Bit 4-5 = 10: Output shift with SYNC1 event (only DC mode)</li> <li>Bit 14 = 1: dynamic times (measurement through writing of 0x1C32:08)</li> </ul>	UINT16	RO	0xC007 (49159 <sub>dec</sub> )
1C32:05	Minimum cycle time	Minimum cycle time (in ns)	UINT32	RO	0x00000000 (0 <sub>dec</sub> )
1C32:06	Calc and copy time	Minimum time between SYNC0 and SYNC1 event (in ns, DC mode only)	UINT32	RO	0x00000000 (0 <sub>dec</sub> )
1C32:08	Command	With this entry the real required process data provision time can be measured. <ul style="list-style-type: none"> <li>0: Measurement of the local cycle time is stopped</li> <li>1: Measurement of the local cycle time is started</li> </ul> <p>The entries 0x1C32:03, 0x1C32:05, 0x1C32:06, 0x1C32:09, 0x1C33:03 [▶_108], 0x1C33:06 [▶_107], 0x1C33:09 [▶_108] are updated with the maximum measured values. For a subsequent measurement the measured values are reset.</p>	UINT16	RW	0x0000 (0 <sub>dec</sub> )
1C32:09	Maximum delay time	Time between SYNC1 event and output of the outputs (in ns, DC mode only)	UINT32	RO	0x00000000 (0 <sub>dec</sub> )
1C32:0B	SM event missed counter	Number of missed SM events in OPERATIONAL (DC mode only)	UINT16	RO	0x0000 (0 <sub>dec</sub> )
1C32:0C	Cycle exceeded counter	Number of occasions the cycle time was exceeded in OPERATIONAL (cycle was not completed in time or the next cycle began too early)	UINT16	RO	0x0000 (0 <sub>dec</sub> )
1C32:0D	Shift too short counter	Number of occasions that the interval between SYNC0 and SYNC1 event was too short (DC mode only)	UINT16	RO	0x0000 (0 <sub>dec</sub> )
1C32:20	Sync error	The synchronization was not correct in the last cycle (outputs were output too late; DC mode only)	BOOLEAN	RO	0x00 (0 <sub>dec</sub> )

## Index 1C33 SM input parameter

Index (hex)	Name	Meaning	Data type	Flags	Default
1C33:0	SM input parameter	Synchronization parameters for the inputs	UINT8	RO	0x20 (32 <sub>dec</sub> )
1C33:01	Sync mode	Current synchronization mode: <ul style="list-style-type: none"> <li>0: Free Run</li> <li>1: Synchron with SM 3 Event (no outputs available)</li> <li>2: DC - Synchron with SYNC0 Event</li> <li>3: DC - Synchron with SYNC1 Event</li> <li>34: Synchron with SM 2 Event (outputs available)</li> </ul>	UINT16	RW	0x0022 (34 <sub>dec</sub> )
1C33:02	Cycle time	as <a href="#">0x1C32:02</a> [▶ 107]	UINT32	RW	0x00000000 (0 <sub>dec</sub> )
1C33:03	Shift time	Time between SYNC0 event and reading of the inputs (in ns, only DC mode)	UINT32	RO	0x00000000 (0 <sub>dec</sub> )
1C33:04	Sync modes supported	Supported synchronization modes: <ul style="list-style-type: none"> <li>Bit 0: free run is supported</li> <li>Bit 1: Synchron with SM 2 Event is supported (outputs available)</li> <li>Bit 1: Synchron with SM 3 Event is supported (no outputs available)</li> <li>Bit 2-3 = 01: DC mode is supported</li> <li>Bit 4-5 = 01: Input shift through local event (outputs available)</li> <li>Bit 4-5 = 10: Input shift with SYNC1 event (no outputs available)</li> <li>Bit 14 = 1: dynamic times (measurement through writing of <a href="#">0x1C32:08</a> [▶ 107] or <a href="#">0x1C33:08</a>)</li> </ul>	UINT16	RO	0xC007 (49159 <sub>dec</sub> )
1C33:05	Minimum cycle time	as <a href="#">0x1C32:05</a> [▶ 107]	UINT32	RO	0x00000000 (0 <sub>dec</sub> )
1C33:06	Calc and copy time	Time between reading of the inputs and availability of the inputs for the master (in ns, only DC mode)	UINT32	RO	0x00000000 (0 <sub>dec</sub> )
1C33:07	Minimum delay time		UINT32	RO	0x00000000 (0 <sub>dec</sub> )
1C33:08	Command	as <a href="#">0x1C32:08</a> [▶ 107]	UINT16	RW	0x0000 (0 <sub>dec</sub> )
1C33:09	Delay time	Time between SYNC1 event and reading of the inputs (in ns, only DC mode)	UINT32	RO	0x00000000 (0 <sub>dec</sub> )
1C33:0B	SM event missed counter	as <a href="#">0x1C32:11</a> [▶ 107]	UINT16	RO	0x0000 (0 <sub>dec</sub> )
1C33:0C	Cycle exceeded counter	as <a href="#">0x1C32:12</a> [▶ 107]	UINT16	RO	0x0000 (0 <sub>dec</sub> )
1C33:0D	Shift too short counter	as <a href="#">0x1C32:13</a> [▶ 107]	UINT16	RO	0x0000 (0 <sub>dec</sub> )
1C33:20	Sync error	as <a href="#">0x1C32:32</a> [▶ 107]	BOOLEAN	RO	0x00 (0 <sub>dec</sub> )

## Index F000 Modular device profile

Index (hex)	Name	Meaning	Data type	Flags	Default
F000:0	Modular device profile	General information for the modular device profile	UINT8	RO	0x02 (2 <sub>dec</sub> )
F000:01	Module index distance	Index distance of the objects of the individual channels	UINT16	RO	0x0010 (16 <sub>dec</sub> )
F000:02	Maximum number of modules	Number of channels	UINT16	RO	0x0001 (1 <sub>dec</sub> )

## Index F008 Code word

Index (hex)	Name	Meaning	Data type	Flags	Default
F008:0	Code word	reserved	UINT32	RW	0x00000000 (0 <sub>dec</sub> )

**Index F010 Module list**

Index (hex)	Name	Meaning	Data type	Flags	Default
F010:0	Module list	Maximum subindex	UINT8	RW	0x02 (2 <sub>dec</sub> )
F010:01	SubIndex 001	reserved	UINT32	RW	0x000001FE (510 <sub>dec</sub> )
F010:02	SubIndex 002	reserved	UINT32	RW	0x000001FF (511 <sub>dec</sub> )

## 6.4 EP5151-0002

### ● Parameterization



You can parameterize the box via the "CoE - Online" tab in TwinCAT.

### ● EtherCAT XML Device Description



The presentation matches that of the EtherCAT XML Device Description.

Recommendation: download the latest XML file from <https://www.beckhoff.com/> and install it according to the installation instructions.

### 6.4.1 Restore object

#### Index 1011 Restore default parameters

Index (hex)	Name	Meaning	Data type	Flags	Default
1011:0	Restore default parameters	Restore the default settings	UINT8	RO	0x01 (1 <sub>dec</sub> )
1011:01	SubIndex 001	If this object is set to " <b>0x64616F6C</b> " in the set value dialog, all backup objects are reset to their delivery state. Note: Some FW versions also accept the following input: <b>0x6C6F6164</b> ".	UINT32	RW	0x00000000 (0 <sub>dec</sub> )

## 6.4.2 Configuration data

### Index 8000 ENC Settings

Index (hex)	Name	Meaning	Data type	Flags	Default
8000:0	ENC Settings	Maximum subindex	UINT8	RO	0x17 (23 <sub>dec</sub> )
8000:01	Enable C reset <a href="#">▶ 69</a>	The counter is reset via the C input.	BOOLEAN	RW	0x00 (0 <sub>dec</sub> )
8000:02	Enable extern reset <a href="#">▶ 69</a>	A counter reset is triggered via the external latch input (24 V).	BOOLEAN	RW	0x00 (0 <sub>dec</sub> )
8000:03	Enable up/down counter <a href="#">▶ 69</a>	Enablement of the up/down counter in place of the encoder with the bit set. Increments are counted at input A. Input B specifies the counting direction.	BOOLEAN	RW	0x00 (0 <sub>dec</sub> )
8000:04	Gate polarity <a href="#">▶ 69</a>	0: Disable gate 1: Enable pos. gate (gate locks with HIGH signal level) 2: Enable neg. gate (gate locks with LOW signal level)	BIT2	RW	0x01 (1 <sub>dec</sub> )
8000:08	Disable filter	0: Activates the input filter (inputs A, /A, B, /B, C, /C only) 1: Deactivates the input filter If a filter is activated a signal edge must be present for at least 2.4 μs in order to be counted as an increment.	BOOLEAN	RW	0x01 (1 <sub>dec</sub> )
8000:0A	Enable micro increments <a href="#">▶ 70</a>	If DC mode is activated, the Box interpolates micro-increments between the integer encoder increments. The lower 8 bits of the <i>Counter Value</i> are used in each case for the display. A 32-bit counter thus becomes a 24+8-bit counter, a 16-bit counter becomes an 8+8-bit counter.	BOOLEAN	RW	0x00 (0 <sub>dec</sub> )
8000:0B	Open circuit detection A <a href="#">▶ 70</a>	An open circuit on track A is indicated in object <i>Open circuit</i> (index 0x6000:07 <a href="#">▶ 113</a> ) and as a process data. Diagnosis is only possible if the corresponding input is wired differentially. A differential voltage < 3.5 V (typical, subject to change) is detected as a broken wire.	BOOLEAN	RW	0x01 (1 <sub>dec</sub> )
8000:0C	Open circuit detection B <a href="#">▶ 70</a>	An open circuit on track B is indicated in object <i>Open circuit</i> (index 0x6000:07 <a href="#">▶ 113</a> ) and as a process data. Diagnosis is only possible if the corresponding input is wired differentially. A differential voltage < 3.5 V (typical, subject to change) is detected as a broken wire.	BOOLEAN	RW	0x01 (1 <sub>dec</sub> )
8000:0D	Open circuit detection C <a href="#">▶ 70</a>	An open circuit on track C is indicated in object <i>Open circuit</i> (index 0x6000:07 <a href="#">▶ 113</a> ) and as a process data. Diagnosis is only possible if the corresponding input is wired differentially. A differential voltage < 3.5 V (typical, subject to change) is detected as a broken wire.	BOOLEAN	RW	0x00 (0 <sub>dec</sub> )
8000:0E	Reversion of rotation <a href="#">▶ 69</a>	Activates reversion of rotation	BOOLEAN	RW	0x00 (0 <sub>dec</sub> )
8000:10	Extern reset polarity <a href="#">▶ 69</a>	0: Fall (the counter is set to zero with a falling edge) 1: Rise (the counter is set to zero with a rising edge)	BIT2	RW	0x01 (1 <sub>dec</sub> )
8000:11	Frequency window <a href="#">▶ 68</a>	This is the minimum time over which the frequency is determined; default value 10 ms [resolution: 1 μs]. The number of pulses in the timeframe + the following is measured. The maximum waiting time is specified in the <i>Frequency Wait Time</i> parameter. The number of pulses is divided by the actual time window size. The determined frequency is output in object <i>Frequency value</i> (index 0x6000:13 <a href="#">▶ 113</a> ) and as a process data. The frequency calculation is carried out locally without distributed clocks function.	UINT16	RW	0x2710 (10000 <sub>dec</sub> )
8000:13	Frequency scaling <a href="#">▶ 68</a>	Scaling of the frequency measurement (must be divided by this value to obtain the unit in Hz): 100: "0.01 Hz"	UINT16	RW	0x0064 (100 <sub>dec</sub> )
8000:14	Period scaling <a href="#">▶ 68</a>	Resolution of the period value in the process data: 100: "100 ns" period value is a multiple of 100 ns 500: "500 ns" period value is a multiple of 500 ns	UINT16	RW	0x0064 (100 <sub>dec</sub> )
8000:15	Frequency resolution <a href="#">▶ 68</a>	Resolution of the frequency measurement: 100: "0.01 Hz"	UINT16	RW	0x0064 (100 <sub>dec</sub> )

Index (hex)	Name	Meaning	Data type	Flags	Default
8000:16	<u>Period resolution</u> ▶ 68]	<p>Internal resolution of the period value measurement: 100: "100 ns" period value is a multiple of 100 ns</p> <p>The period is calculated internally with a resolution of 100 ns. The max. measurable period can then be approx. 1.6 seconds.</p> <p>500: "500 ns" period value is a multiple of 500 ns</p> <p>Internally the period is calculated with 500 ns resolution. The maximum measurable period is approx. 32.7 ms. The resolution of the process data continues to be the value according to object <i>Period scaling</i> (index 0x8000:14) (e.g., 100 ns [default]).</p>	UINT16	RW	0x0064 (100 <sub>dec</sub> )
8000:17	<u>Frequency wait time</u> ▶ 68]	<p>Waiting time [ms] for frequency measurement</p> <p>Once the time specified in the <i>frequency window</i> has elapsed, the system waits for the next positive edge from track A. This enables the update speed for the <i>Frequency</i> process data to be optimized, depending on the expected frequencies. The minimum value to be entered here is twice the period value of the smallest measured frequency.</p> <p><math>T \geq 2 * (1 / f_{min})</math></p>	UINT16	RW	0x0640 (1600 <sub>dec</sub> )



### 6.4.3 Input data

#### Index 6000 ENC Inputs

Index (hex)	Name	Meaning	Data type	Flags	Default
6000:0	ENC Inputs	Maximum subindex	UINT8	RO	0x16 (22 <sub>dec</sub> )
6000:01	Latch C valid <a href="#">[▶ 69]</a>	The counter value was latched with the “C” input. The data with <i>Latch Value</i> (Index 0x6000:12) corresponds to the latched value if the bit is set. To re-enable the latch input, <i>Enable latch C</i> (index 0x7000:01 <a href="#">[▶ 114]</a> ) must be canceled and then reset.	BOOLEAN	RO	0x00 (0 <sub>dec</sub> )
6000:02	Latch extern valid <a href="#">[▶ 69]</a>	The counter value was locked via the external latch. The data with <i>Latch Value</i> (Index 0x6000:12) corresponds to the latched value if the bit is set. To re-enable the latch input, <i>Enable latch extern on positive edge</i> (index 0x7000:02 <a href="#">[▶ 114]</a> ) or object <i>Enable latch extern on negative edge</i> (index 0x7000:04 <a href="#">[▶ 114]</a> ) must first be canceled and then reset.	BOOLEAN	RO	0x00 (0 <sub>dec</sub> )
6000:03	Set counter done	The counter was set.	BOOLEAN	RO	0x00 (0 <sub>dec</sub> )
6000:04	Counter underflow <a href="#">[▶ 70]</a>	The counter has passed the zero crossing backwards. Overflow/underflow control is inactive in combination with a reset function (C/external).	BOOLEAN	RO	0x00 (0 <sub>dec</sub> )
6000:05	Counter overflow <a href="#">[▶ 70]</a>	Counter overflow. Overflow/underflow control is inactive in combination with a reset function (C/external).	BOOLEAN	RO	0x00 (0 <sub>dec</sub> )
6000:06	Status of input status	State of the status input (alarm “input 1”)	BOOLEAN	RO	0x00 (0 <sub>dec</sub> )
6000:07	Open circuit <a href="#">[▶ 70]</a>	Indicates an open circuit. Configuration via object: <i>Open circuit detection A</i> Index 0x8000:0B <a href="#">[▶ 111]</a> , <i>Open circuit detection B</i> Index 0x8000:0C <a href="#">[▶ 111]</a> <i>Open circuit detection C</i> Index 0x8000:0D <a href="#">[▶ 111]</a> ,	BOOLEAN	RO	0x00 (0 <sub>dec</sub> )
6000:08	Extrapolation stall <a href="#">[▶ 70]</a>	The extrapolated part of the counter is invalid.	BOOLEAN	RO	0x00 (0 <sub>dec</sub> )
6000:09	Status of input A	Status of input A	BOOLEAN	RO	0x00 (0 <sub>dec</sub> )
6000:0A	Status of input B	Status of input B	BOOLEAN	RO	0x00 (0 <sub>dec</sub> )
6000:0B	Status of input C	Status of input C	BOOLEAN	RO	0x00 (0 <sub>dec</sub> )
6000:0C	Status of input gate	The state of the gate input	BOOLEAN	RO	0x00 (0 <sub>dec</sub> )
6000:0D	Status of external ledge	Status of the extern latch input	BOOLEAN	RO	0x00 (0 <sub>dec</sub> )
6000:0E	Sync error	The Sync error bit is only required for DC mode. It indicates whether a synchronization error has occurred during the previous cycle. This means a SYNC signal was triggered in the Box, although no new process data were available (0=OK, 1=NOK).	BOOLEAN	RO	0x00 (0 <sub>dec</sub> )
6000:0F	TxPDO State	Validity of the data of the associated TxPDO (0 = valid, 1 = invalid).	BOOLEAN	RO	0x00 (0 <sub>dec</sub> )
6000:10	TxPDO Toggle	The TxPDO toggle is toggled by the slave when the data of the associated TxPDO is updated.	BOOLEAN	RO	0x00 (0 <sub>dec</sub> )
6000:11	Counter value	Counter value	UINT32	RO	0x00000000 (0 <sub>dec</sub> )
6000:12	Latch value	Latch value	UINT32	RO	0x00000000 (0 <sub>dec</sub> )
6000:13	Frequency value	The frequency (setting of the scaling in index 0x8000:13 <a href="#">[▶ 111]</a> and resolution in index 0x8000:15 <a href="#">[▶ 111]</a> )	UINT32	RO	0x00000000 (0 <sub>dec</sub> )
6000:14	Period value	The period value (setting of the scaling in index 0x8000:14 <a href="#">[▶ 111]</a> and resolution in index 0x8000:16 <a href="#">[▶ 111]</a> )	UINT32	RO	0x00000000 (0 <sub>dec</sub> )
6000:16	Timestamp	Timestamp of the last counter change	UINT64	RO	

## 6.4.4 Output data

### Index 7000 ENC Outputs

Index (hex)	Name	Meaning	Data type	Flags	Default
7000:0	ENC Outputs	Maximum subindex	UINT8	RO	0x11(17 <sub>dec</sub> )
7000:01	Enable latch C <a href="#">[► 69]</a>	Activate latching via input "C".	BOOLEAN	RO	0x00 (0 <sub>dec</sub> )
7000:01	Enable latch extern on positive edge <a href="#">[► 69]</a>	Activate external latch with positive edge.	BOOLEAN	RO	0x00 (0 <sub>dec</sub> )
7000:03	Set counter	Set counter value	BOOLEAN	RO	0x00 (0 <sub>dec</sub> )
7000:04	Enable latch extern on negative edge <a href="#">[► 69]</a>	Activate external latch with negative edge.	BOOLEAN	RO	0x00 (0 <sub>dec</sub> )
7000:11	Set counter value	The counter value to be set via <i>Set counter</i> (index 0x7000:03).	UINT32	RO	0x00000000 (0 <sub>dec</sub> )

## 6.4.5 Standard objects

The standard objects have the same meaning for all EtherCAT slaves.

### Index 1000 Device type

Index (hex)	Name	Meaning	Data type	Flags	Default
1000:0	Device type	Device type of the EtherCAT slave: The Lo-Word contains the CoE profile used (5001). The Hi-Word contains the module profile according to the modular device profile.	UINT32	RO	0x01FF1389 (33493897 <sub>dec</sub> )

### Index 1008 Device name

Index (hex)	Name	Meaning	Data type	Flags	Default
1008:0	Device name	Device name of the EtherCAT slave	STRING	RO	EP5151-0002

### Index 1009 Hardware version

Index (hex)	Name	Meaning	Data type	Flags	Default
1009:0	Hardware version	Hardware version of the EtherCAT slave	STRING	RO	-

### Index 100A Software version

Index (hex)	Name	Meaning	Data type	Flags	Default
100A:0	Software version	Firmware version of the EtherCAT slave	STRING	RO	-

### Index 1018 Identity

Index (hex)	Name	Meaning	Data type	Flags	Default
1018:0	Identity	Information for identifying the slave	UINT8	RO	0x04 (4 <sub>dec</sub> )
1018:01	Vendor ID	Vendor ID of the EtherCAT slave	UINT32	RO	0x00000002 (2 <sub>dec</sub> )
1018:02	Product code	Product code of the EtherCAT slave	UINT32	RO	0x141F4052 (337592402 <sub>dec</sub> )
1018:03	Revision	Revision number of the EtherCAT slave; the Low Word (bit 0-15) indicates the special terminal number, the High Word (bit 16-31) refers to the device description	UINT32	RO	0x00000000 (0 <sub>dec</sub> )
1018:04	Serial number	Serial number of the EtherCAT slave; the Low Byte (bit 0-7) of the Low Word contains the year of production, the High Byte (bit 8-15) of the Low Word contains the week of production, the High Word (bit 16-31) is 0	UINT32	RO	0x00000000 (0 <sub>dec</sub> )

**Index 10F0 Backup parameter handling**

Index (hex)	Name	Meaning	Data type	Flags	Default
10F0:0	Backup parameter handling	Information for standardized loading and saving of backup entries	UINT8	RO	0x01 (1 <sub>dec</sub> )
10F0:01	Checksum	Checksum across all backup entries of the EtherCAT slave	UINT32	RO	0x00000000 (0 <sub>dec</sub> )

**Index 1400 ENC RxPDO-Par Control compact**

Index (hex)	Name	Meaning	Data type	Flags	Default
1400:0	ENC RxPDO-Par Control compact	PDO Parameter RxPDO 1	UINT8	RO	0x06 (6 <sub>dec</sub> )
1400:06	Exclude RxPDOs	Specifies the RxPDOs (index of RxPDO mapping objects) that must not be transferred together with RxPDO 1	OCTET-STRING[2]	RO	01 16

**Index 1401 ENC RxPDO-Par Control**

Index (hex)	Name	Meaning	Data type	Flags	Default
1401:0	ENC RxPDO-Par Control	PDO Parameter RxPDO 2	UINT8	RO	0x06 (6 <sub>dec</sub> )
1401:06	Exclude RxPDOs	Specifies the RxPDOs (index of RxPDO mapping objects) that must not be transferred together with RxPDO 2	OCTET-STRING[2]	RO	00 16

**Index 1600 ENC RxPDO-Map Control compact**

Index (hex)	Name	Meaning	Data type	Flags	Default
1600:0	ENC RxPDO-Map Control compact	PDO Mapping RxPDO 3	UINT8	RO	0x07 (7 <sub>dec</sub> )
1600:01	SubIndex 001	1. PDO Mapping entry (object 0x7000 (ENC Outputs), entry 0x01 (Enable latch C))	UINT32	RO	0x7000:01,1
1600:02	SubIndex 002	2. PDO Mapping entry (object 0x7000 (ENC Outputs), entry 0x02 (Enable latch extern on positive edge))	UINT32	RO	0x7000:02,1
1600:03	SubIndex 003	3. PDO Mapping entry (object 0x7000 (ENC Outputs), entry 0x03 (Set counter))	UINT32	RO	0x7000:03, 1
1600:04	SubIndex 004	4. PDO Mapping entry (object 0x7000 (ENC Outputs), entry 0x04 (Enable latch extern on negative edge))	UINT32	RO	0x7000:04, 1
1600:05	SubIndex 005	5. PDO Mapping entry (4 bits align)	UINT32	RO	0x0000:00, 4
1600:06	SubIndex 006	6. PDO Mapping entry (8 bits align)	UINT32	RO	0x0000:00, 8
1600:07	SubIndex 007	7. PDO Mapping entry (object 0x7000 (ENC Outputs), entry 0x11 (Set counter value))	UINT32	RO	0x7000:11, 16

**Index 1601 ENC RxPDO-Map Control**

Index (hex)	Name	Meaning	Data type	Flags	Default
1601:0	ENC RxPDO-Map Control	PDO Mapping RxPDO	UINT8	RO	0x07 (7 <sub>dec</sub> )
1601:01	SubIndex 001	1. PDO Mapping entry (object 0x7000 (ENC Outputs), entry 0x01 (Enable latch C))	UINT32	RO	0x7000:01,1
1601:02	SubIndex 002	2. PDO Mapping entry (object 0x7000 (ENC Outputs), entry 0x02 (Enable latch extern on positive edge))	UINT32	RO	0x7000:02,1
1601:03	SubIndex 003	3. PDO Mapping entry (object 0x7000 (ENC Outputs), entry 0x03 (Set counter))	UINT32	RO	0x7000:03,1
1601:04	SubIndex 004	4. PDO Mapping entry (object 0x7000 (ENC Outputs), entry 0x04 (Enable latch extern on negative edge))	UINT32	RO	0x7000:04,1
1601:05	SubIndex 005	5. PDO Mapping entry (4 bits align)	UINT32	RO	0x0000:00,4
1601:06	SubIndex 006	6. PDO Mapping entry (8 bits align)	UINT32	RO	0x0000:00,8
1601:07	SubIndex 007	7. PDO Mapping entry (object 0x7000 (ENC Outputs), entry 0x11 (Set counter value))	UINT32	RO	0x7000:11,32

**Index 1800 ENC TxPDO-Par Status compact**

Index (hex)	Name	Meaning	Data type	Flags	Default
1800:0	ENC TxPDO-Par Status compact	PDO parameter TxPDO 1	UINT8	RO	0x09 (9 <sub>dec</sub> )
1800:06	Exclude TxPDOs	Specifies the TxPDOs (index of TxPDO mapping objects) that must not be transferred together with TxPDO 1.	OCTET-STRING[2]	RO	01 1A
1800:07	TxPDO State	The TxPDO state is set if it was not possible to correctly read in the associated input data.	BOOLEAN	RO	0x00 (0 <sub>dec</sub> )
1800:09	TxPDO Toggle	The TxPDO toggle is toggled with each update the corresponding input data.	BOOLEAN	RO	0x00 (0 <sub>dec</sub> )

**Index 1801 ENC TxPDO-Par Status**

Index (hex)	Name	Meaning	Data type	Flags	Default
1801:0	ENC TxPDO-Par Status	PDO parameter TxPDO 2	UINT8	RO	0x09 (9 <sub>dec</sub> )
1801:06	Exclude TxPDOs	Specifies the TxPDOs (index of TxPDO mapping objects) that must not be transferred together with TxPDO 2.	OCTET-STRING[2]	RO	00 1A
1801:07	TxPDO State	The TxPDO state is set if it was not possible to correctly read in the associated input data.	BOOLEAN	RO	0x00 (0 <sub>dec</sub> )
1801:09	TxPDO Toggle	The TxPDO toggle is toggled with each update the corresponding input data.	BOOLEAN	RO	0x00 (0 <sub>dec</sub> )

**Index 1802 ENC TxPDO-Par Frequency**

Index (hex)	Name	Meaning	Data type	Flags	Default
1802:0	ENC TxPDO-Par Frequency	PDO parameter TxPDO 3	UINT8	RO	0x06 (6 <sub>dec</sub> )
1802:06	Exclude TxPDOs	Specifies the TxPDOs (index of TxPDO mapping objects) that must not be transferred together with TxPDO 3.	OCTET-STRING[2]	RO	03 1A

**Index 1803 ENC TxPDO-Par Period**

Index (hex)	Name	Meaning	Data type	Flags	Default
1803:0	ENC TxPDO-Par Period	PDO parameter TxPDO 4	UINT8	RO	0x06 (6 <sub>dec</sub> )
1803:06	Exclude TxPDOs	Specifies the TxPDOs (index of TxPDO mapping objects) that must not be transferred together with TxPDO 4.	OCTET-STRING[2]	RO	02 1A

**Index 1804 ENC TxPDO-Par Timestamp**

Index (hex)	Name	Meaning	Data type	Flags	Default
1804:0	ENC TxPDO-Par Timestamp	PDO parameter TxPDO 5	UINT8	RO	0x06 (6 <sub>dec</sub> )
1804:06	Exclude TxPDOs	Specifies the TxPDOs (index of TxPDO mapping objects) that must not be transferred together with TxPDO 5.	OCTET-STRING[2]	RO	05 1A

**Index 1805 ENC TxPDO-Par Timestamp compact**

Index (hex)	Name	Meaning	Data type	Flags	Default
1805:0	ENC TxPDO-Par Timestamp compact	PDO parameter TxPDO 6	UINT8	RO	0x06 (6 <sub>dec</sub> )
1805:06	Exclude TxPDOs	Specifies the TxPDOs (index of TxPDO mapping objects) that must not be transferred together with TxPDO 6.	OCTET-STRING[2]	RO	04 1A

**Index 1A00 ENC TxPDO-Map Status compact**

Index (hex)	Name	Meaning	Data type	Flags	Default
1A00:0	ENC TxPDO-Map Status	ENC TxPDO-Map Status compact	UINT8	RO	0x012 (18 <sub>dec</sub> )
1A00:01	SubIndex 001	1. PDO Mapping entry (object 0x6000 (ENC Inputs), entry 0x01 (Latch C valid))	UINT32	RO	0x6000:01, 1
1A00:02	SubIndex 002	2. PDO Mapping entry (object 0x6000 (ENC Inputs), entry 0x02 (Latch extern valid))	UINT32	RO	0x6000:02, 1
1A00:03	SubIndex 003	3. PDO Mapping entry (object 0x6000 (ENC Inputs), entry 0x03 (Set counter done))	UINT32	RO	0x6000:03, 1
1A00:04	SubIndex 004	4. PDO Mapping entry (object 0x6000 (ENC Inputs), entry 0x04 (Counter underflow))	UINT32	RO	0x6000:04, 1
1A00:05	SubIndex 005	5. PDO Mapping entry (object 0x6000 (ENC Inputs), entry 0x05 (Counter overflow))	UINT32	RO	0x6000:05, 1
1A00:06	SubIndex 006	6. PDO Mapping entry (object 0x6000 (ENC Inputs), entry 0x06 (Status of input status))	UINT32	RO	0x6000:06, 1
1A00:07	SubIndex 007	7. PDO Mapping entry (object 0x6000 (ENC Inputs), entry 0x07 (Open circuit))	UINT32	RO	0x6000:07, 1
1A00:08	SubIndex 008	8. PDO Mapping entry (object 0x6000 (ENC Inputs), entry 0x08 (Extrapolation stall))	UINT32	RO	0x6000:08, 1
1A00:09	SubIndex 009	9. PDO Mapping entry (object 0x6000 (ENC Inputs), entry 0x09 (Status of input A))	UINT32	RO	0x6000:09, 1
1A00:0A	SubIndex 010	10. PDO Mapping entry (object 0x6000 (ENC Inputs), entry 0x0A (Status of input B))	UINT32	RO	0x6000:0A, 1
1A00:0B	SubIndex 011	11. PDO Mapping entry (object 0x6000 (ENC Inputs), entry 0x0B (Status of input C))	UINT32	RO	0x6000:0B, 1
1A00:0C	SubIndex 012	12. PDO Mapping entry (object 0x6000 (ENC Inputs), entry 0x0C (Status of input gate))	UINT32	RO	0x6000:0C, 1
1A00:0D	SubIndex 013	13. PDO Mapping entry (object 0x6000 (ENC Inputs), entry 0x0D (Status of extern latch))	UINT32	RO	0x6000:0D, 1
1A00:0E	SubIndex 014	14. PDO Mapping entry (object 0x1C32 (SM output parameter), entry 0x20 (Sync error))	UINT32	RO	0x1C32:20, 1
1A00:0F	SubIndex 015	15. PDO Mapping entry (object 0x1800 (ENC TxPDO-Par Status compact), entry 0x07 (TxPDO State))	UINT32	RO	0x1800:07, 1
1A00:10	SubIndex 016	16. PDO Mapping entry (object 0x1800 (ENC TxPDO-Par Status compact), entry 0x09 (TxPDO Toggle))	UINT32	RO	0x1800:09, 1
1A00:11	SubIndex 017	17. PDO Mapping entry (object 0x6000 (ENC Inputs), entry 0x11 (Counter value))	UINT32	RO	0x6000:11, 16
1A00:12	SubIndex 018	18. PDO Mapping entry (object 0x6000 (ENC Inputs), entry 0x12 (Latch value))	UINT32	RO	0x6000:12, 16

## Index 1A01 ENC TxPDO-Map Status

Index (hex)	Name	Meaning	Data type	Flags	Default
1A01:0	ENC TxPDO-Map Status compact	PDO Mapping TxPDO 2	UINT8	RO	0x12 (17 <sub>dec</sub> )
1A01:01	SubIndex 001	1. PDO Mapping entry (object 0x6000 (ENC Inputs), entry 0x01 (Latch C valid))	UINT32	RO	0x6000:01, 1
1A01:02	SubIndex 002	2. PDO Mapping entry (object 0x6000 (ENC Inputs), entry 0x02 (Latch extern valid))	UINT32	RO	0x6000:02, 1
1A01:03	SubIndex 003	3. PDO Mapping entry (object 0x6000 (ENC Inputs), entry 0x03 (Set counter done))	UINT32	RO	0x6000:03, 1
1A01:04	SubIndex 004	4. PDO Mapping entry (object 0x6000 (ENC Inputs), entry 0x04 (Counter underflow))	UINT32	RO	0x6000:04, 1
1A01:05	SubIndex 005	5. PDO Mapping entry (object 0x6000 (ENC Inputs), entry 0x05 (Counter overflow))	UINT32	RO	0x6000:05, 1
1A01:06	SubIndex 006	6. PDO Mapping entry (object 0x6000 (ENC Inputs), entry 0x06 (Status of input status))	UINT32	RO	0x6000:06, 1
1A01:07	SubIndex 007	7. PDO Mapping entry (object 0x6000 (ENC Inputs), entry 0x07 (Open circuit))	UINT32	RO	0x6000:07, 1
1A01:08	SubIndex 008	8. PDO Mapping entry (object 0x6000 (ENC Inputs), entry 0x08 (Extrapolation stall))	UINT32	RO	0x6000:08, 1
1A01:09	SubIndex 009	9. PDO Mapping entry (object 0x6000 (ENC Inputs), entry 0x09 (Status of input A))	UINT32	RO	0x6000:09, 1
1A01:0A	SubIndex 010	10. PDO Mapping entry (object 0x6000 (ENC Inputs), entry 0x0A (Status of input B))	UINT32	RO	0x6000:0A, 1
1A01:0B	SubIndex 011	11. PDO Mapping entry (object 0x6000 (ENC Inputs), entry 0x0B (Status of input C))	UINT32	RO	0x6000:0B, 1
1A01:0C	SubIndex 012	12. PDO Mapping entry (object 0x6000 (ENC Inputs), entry 0x0C (Status of input gate))	UINT32	RO	0x6000:0C, 1
1A01:0D	SubIndex 013	13. PDO Mapping entry (object 0x6000 (ENC Inputs), entry 0x0D (Status of extern latch))	UINT32	RO	0x6000:0D, 1
1A01:0E	SubIndex 014	14. PDO Mapping entry (object 0x1C32 (SM output parameter), entry 0x20 (Sync error))	UINT32	RO	0x1C32:20, 1
1A01:0F	SubIndex 015	15. PDO Mapping entry (object 0x1801 (ENC TxPDO-Par Status), entry 0x07 (TxPDO State))	UINT32	RO	0x1801:07, 1
1A01:10	SubIndex 016	16. PDO Mapping entry (object 0x1801 (ENC TxPDO-Par Status), entry 0x09 (TxPDO Toggle))	UINT32	RO	0x1801:09, 1
1A01:11	SubIndex 017	17. PDO Mapping entry (object 0x6000 (ENC Inputs), entry 0x11 (Counter value))	UINT32	RO	0x6000:11, 32
1A01:12	SubIndex 018	18. PDO Mapping entry (object 0x6000 (ENC Inputs), entry 0x12 (Latch value))	UINT32	RO	0x6000:12, 32

## Index 1A02 ENC TxPDO-Map Frequency

Index (hex)	Name	Meaning	Data type	Flags	Default
1A02:0	TxPDO map frequency	PDO Mapping TxPDO	UINT8	RO	0x01 (1 <sub>dec</sub> )
1A02:01	SubIndex 001	1. PDO Mapping entry (object 0x6000 (Inputs), entry 0x13 (Frequency value))	UINT32	RO	0x6000:13, 32

## Index 1A03 ENC TxPDO-Map Period

Index (hex)	Name	Meaning	Data type	Flags	Default
1A03:0	ENC TxPDO-Map Period	ENC TxPDO-Map Period	UINT8	RO	0x01 (1 <sub>dec</sub> )
1A03:01	SubIndex 001	1. PDO Mapping entry (object 0x6010 (ENC Inputs), entry 0x14 (Period value))	UINT32	RO	0x6000:14,32

## Index 1A04 ENC TxPDO-Map Timest.

Index (hex)	Name	Meaning	Data type	Flags	Default
1A04:0	ENC TxPDO-Map Timest. compact	PDO Mapping TxPDO	UINT8	RO	0x01 (1 <sub>dec</sub> )
1A04:01	SubIndex 001	1. PDO Mapping entry (object 0x6010 (ENC Inputs), entry 0x16 (Timestamp))	UINT32	RO	0x6000:16, 64

**Index 1A05 ENC TxPDO-Map Timest. compact**

Index (hex)	Name	Meaning	Data type	Flags	Default
1A05:0	ENC TxPDO-Map Timest. compact	PDO Mapping TxPDO	UINT8	RO	0x01 (1 <sub>dec</sub> )
1A05:01	SubIndex 001	1. PDO Mapping entry (object 0x6000 (ENC Inputs), entry 0x16 (Timestamp))	UINT32	RO	0x6000:16, 32

**Index 1C00 Sync manager type**

Index (hex)	Name	Meaning	Data type	Flags	Default
1C00:0	Sync manager type	Using the Sync Managers	UINT8	RO	0x04 (4 <sub>dec</sub> )
1C00:01	SubIndex 001	Sync-Manager Type Channel 1: Mailbox Write	UINT8	RO	0x01 (1 <sub>dec</sub> )
1C00:02	SubIndex 002	Sync-Manager Type Channel 2: Mailbox Read	UINT8	RO	0x02 (2 <sub>dec</sub> )
1C00:03	SubIndex 003	Sync-Manager Type Channel 3: Process Data Write(Outputs)	UINT8	RO	0x03 (3 <sub>dec</sub> )
1C00:04	SubIndex 004	Sync-Manager Type Channel 4: Process Data Read (Inputs)	UINT8	RO	0x04 (4 <sub>dec</sub> )

**Index 1C12 RxPDO assign**

Index (hex)	Name	Meaning	Data type	Flags	Default
1C12:0	RxPDO assign	PDO Assign Outputs	UINT8	RW	0x01 (1 <sub>dec</sub> )
1C12:01	SubIndex 001	1. allocated RxPDO (contains the index of the associated RxPDO mapping object)	UINT16	RW	0x1600 (5632 <sub>dec</sub> )

**Index 1C13 TxPDO assign**

Index (hex)	Name	Meaning	Data type	Flags	Default
1C13:0	TxPDO assign	PDO Assign Inputs	UINT8	RW	0x01 (1 <sub>dec</sub> )
1C13:01	SubIndex 001	1. allocated TxPDO (contains the index of the associated TxPDO mapping object)	UINT16	RW	0x1A00 (6656 <sub>dec</sub> )
1C13:02	SubIndex 002	2. allocated TxPDO (contains the index of the associated TxPDO mapping object)	UINT16	RW	0x0000 (0 <sub>dec</sub> )
1C13:03	SubIndex 003	3. allocated TxPDO (contains the index of the associated TxPDO mapping object)	UINT16	RW	0x0000 (0 <sub>dec</sub> )

## Index 1C32 SM output parameter

Index (hex)	Name	Meaning	Data type	Flags	Default
1C32:0	SM output parameter	Synchronization parameters for the outputs	UINT8	RO	0x20 (32 <sub>dec</sub> )
1C32:01	Sync mode	Current synchronization mode: <ul style="list-style-type: none"> <li>0: Free Run</li> <li>1: Synchron with SM 2 Event</li> <li>2: DC-Mode - Synchron with SYNC0 Event</li> <li>3: DC-Mode - Synchron with SYNC1 Event</li> </ul>	UINT16	RW	0x0001 (1 <sub>dec</sub> )
1C32:02	Cycle time	Cycle time (in ns): <ul style="list-style-type: none"> <li>Free Run: Cycle time of the local timer</li> <li>Synchron with SM 2 Event: Master cycle time</li> <li>DC mode: SYNC0/SYNC1 Cycle Time</li> </ul>	UINT32	RW	0x00000000 (0 <sub>dec</sub> )
1C32:03	Shift time	Time between SYNC0 event and output of the outputs (in ns, DC mode only)	UINT32	RO	0x00000000 (0 <sub>dec</sub> )
1C32:04	Sync modes supported	Supported synchronization modes: <ul style="list-style-type: none"> <li>Bit 0 = 1: free run is supported</li> <li>Bit 1 = 1: Synchron with SM 2 Event is supported</li> <li>Bit 2-3 = 01: DC mode is supported</li> <li>Bit 4-5 = 10: Output shift with SYNC1 event (only DC mode)</li> <li>Bit 14 = 1: dynamic times (measurement through writing of 0x1C32:08)</li> </ul>	UINT16	RO	0xC007 (49159 <sub>dec</sub> )
1C32:05	Minimum cycle time	Minimum cycle time (in ns)	UINT32	RO	0x00000000 (0 <sub>dec</sub> )
1C32:06	Calc and copy time	Minimum time between SYNC0 and SYNC1 event (in ns, DC mode only)	UINT32	RO	0x00000000 (0 <sub>dec</sub> )
1C32:07	Minimum delay time		UINT32	RO	0x00000000 (0 <sub>dec</sub> )
1C32:08	Command	With this entry the real required process data provision time can be measured. <ul style="list-style-type: none"> <li>0: Measurement of the local cycle time is stopped</li> <li>1: Measurement of the local cycle time is started</li> </ul> <p>The entries 0x1C32:03, 0x1C32:05, 0x1C32:06, 0x1C32:09, 0x1C33:03, 0x1C33:06, 0x1C33:09 are updated with the maximum measured values. For a subsequent measurement the measured values are reset</p>	UINT16	RW	0x0000 (0 <sub>dec</sub> )
1C32:09	Maximum delay time	Time between SYNC1 event and output of the outputs (in ns, DC mode only)	UINT32	RO	0x00000000 (0 <sub>dec</sub> )
1C32:0B	SM event missed counter	Number of missed SM events in OPERATIONAL (DC mode only)	UINT16	RO	0x0000 (0 <sub>dec</sub> )
1C32:0C	Cycle exceeded counter	Number of occasions the cycle time was exceeded in OPERATIONAL (cycle was not completed in time or the next cycle began too early)	UINT16	RO	0x0000 (0 <sub>dec</sub> )
1C32:0D	Shift too short counter	Number of occasions that the interval between SYNC0 and SYNC1 event was too short (DC mode only)	UINT16	RO	0x0000 (0 <sub>dec</sub> )
1C32:20	Sync error	The synchronization was not correct in the last cycle (outputs were output too late; DC mode only)	BOOLEAN	RO	0x00 (0 <sub>dec</sub> )



**Index 1C33 SM input parameter**

Index (hex)	Name	Meaning	Data type	Flags	Default
1C33:0	SM input parameter	Synchronization parameters for the inputs	UINT8	RO	0x20 (32 <sub>dec</sub> )
1C33:01	Sync mode	Current synchronization mode: <ul style="list-style-type: none"> <li>• 0: Free Run</li> <li>• 1: Synchron with SM 3 Event (no outputs available)</li> <li>• 2: DC - Synchron with SYNC0 Event</li> <li>• 3: DC - Synchron with SYNC1 Event</li> <li>• 34: Synchron with SM 2 Event (outputs available)</li> </ul>	UINT16	RW	0x0022 (34 <sub>dec</sub> )
1C33:02	Cycle time	as 0x1C32:02	UINT32	RW	0x00000000 (0 <sub>dec</sub> )
1C33:03	Shift time	Time between SYNC0 event and reading of the inputs (in ns, only DC mode)	UINT32	RO	0x00000000 (0 <sub>dec</sub> )
1C33:04	Sync modes supported	Supported synchronization modes: <ul style="list-style-type: none"> <li>• Bit 0: free run is supported</li> <li>• Bit 1: Synchron with SM 2 Event is supported (outputs available)</li> <li>• Bit 1: Synchron with SM 3 Event is supported (no outputs available)</li> <li>• Bit 2-3 = 01: DC mode is supported</li> <li>• Bit 4-5 = 01: Input shift through local event (outputs available)</li> <li>• Bit 4-5 = 10: Input shift with SYNC1 event (no outputs available)</li> <li>• Bit 14 = 1: dynamic times (measurement through writing of 0x1C32:08 or 0x1C33:08)</li> </ul>	UINT16	RO	0xC007 (49159 <sub>dec</sub> )
1C33:05	Minimum cycle time	as 0x1C32:05	UINT32	RO	0x00000000 (0 <sub>dec</sub> )
1C33:06	Calc and copy time	Time between reading of the inputs and availability of the inputs for the master (in ns, only DC mode)	UINT32	RO	0x00000000 (0 <sub>dec</sub> )
1C33:06	Minimum delay time		UINT32	RO	0x00000000 (0 <sub>dec</sub> )
1C33:08	Command	as 0x1C32:08	UINT16	RW	0x0000 (0 <sub>dec</sub> )
1C33:09	Maximum delay time	Time between SYNC1 event and reading of the inputs (in ns, only DC mode)	UINT32	RO	0x00000000 (0 <sub>dec</sub> )
1C33:0B	SM event missed counter	as 0x1C32:11	UINT16	RO	0x0000 (0 <sub>dec</sub> )
1C33:0C	Cycle exceeded counter	as 0x1C32:12	UINT16	RO	0x0000 (0 <sub>dec</sub> )
1C33:0D	Shift too short counter	as 0x1C32:13	UINT16	RO	0x0000 (0 <sub>dec</sub> )
1C33:20	Sync error	as 0x1C32:32	BOOLEAN	RO	0x00 (0 <sub>dec</sub> )

**Index F000 Modular device profile**

Index (hex)	Name	Meaning	Data type	Flags	Default
F000:0	Modular device profile	General information for the modular device profile	UINT8	RO	0x02 (2 <sub>dec</sub> )
F000:01	Module index distance	Index distance of the objects of the individual channels	UINT16	RO	0x0010 (16 <sub>dec</sub> )
F000:02	Maximum number of modules	Number of channels	UINT16	RO	0x0001 (1 <sub>dec</sub> )

**Index F008 Code word**

Index (hex)	Name	Meaning	Data type	Flags	Default
F008:0	Code word	reserved	UINT32	RW	0x00000000 (0 <sub>dec</sub> )

**Index F010 Module list**

Index (hex)	Name	Meaning	Data type	Flags	Default
F010:0	Module list	Maximum subindex	UINT8	RW	0x01 (1 <sub>dec</sub> )
F010:01	SubIndex 001	reserved	UINT32	RW	0x000001FF (511 <sub>dec</sub> )

# 7 Appendix

## 7.1 General operating conditions

### Protection rating according to IP code

The degrees of protection are defined and divided into different classes in the IEC 60529 standard (EN 60529). Degrees of protection are designated by the letters "IP" and two numerals: **IPxy**

- Numeral x: Dust protection and contact protection
- Numeral y: Protection against water

x	Meaning
0	Not protected
1	Protected against access to dangerous parts with the back of the hand. Protected against solid foreign objects of 50 mm Ø
2	Protected against access to dangerous parts with a finger. Protected against solid foreign objects of 12.5 mm Ø
3	Protected against access to dangerous parts with a tool. Protected against solid foreign objects of 2.5 mm Ø
4	Protected against access to dangerous parts with a wire. Protected against solid foreign objects of 1 mm Ø
5	Protection against access to dangerous parts with a wire. Dust-protected. Ingress of dust is not prevented completely, although the quantity of dust able to penetrate is limited to such an extent that the proper function of the device and safety are not impaired
6	Protection against access to dangerous parts with a wire. Dust-tight. No ingress of dust

y	Meaning
0	Not protected
1	Protection against vertically falling water drops
2	Protection against vertically falling water drops when enclosure tilted up to 15°
3	Protection against spraying water. Water sprayed at an angle of up to 60° on either side of the vertical shall have no harmful effects
4	Protection against splashing water. Water splashed against the enclosure from any direction shall have no harmful effects
5	Protection against water jets.
6	Protection against powerful water jets.
7	Protected against the effects of temporary immersion in water. Ingress of water in quantities causing harmful effects shall not be possible when the enclosure is immersed in water at a depth of 1 m for 30 minutes

### Chemical resistance

The resistance refers to the housing of the IP67 modules and the metal parts used. In the table below you will find some typical resistances.

Type	Resistance
Water vapor	unstable at temperatures > 100 °C
Sodium hydroxide solution (ph value > 12)	stable at room temperature unstable > 40 °C
Acetic acid	unstable
Argon (technically pure)	stable

### Key

- resistant: Lifetime several months
- non inherently resistant: Lifetime several weeks
- not resistant: Lifetime several hours resp. early decomposition

## 7.2 Accessories

### Mounting

Ordering information	Description	Link
ZS5300-0011	Mounting rail	<a href="#">Website</a>

### Labeling material, protective caps

Ordering information	Description
ZS5000-0010	Protective cap for M8 sockets, IP67 (50 pieces)
ZS5100-0000	Inscription labels, unprinted, 4 strips of 10
ZS5000-xxxx	Printed inscription labels on enquiry
ZS5000-0020	Protective cap for M12 sockets, IP67 (50 pcs.)

### Cables

A complete overview of pre-assembled cables for fieldbus components can be found [here](#).

Ordering information	Description	Link
ZK1090-3xxx-xxxx	EtherCAT cable M8, green	<a href="#">Website</a>
ZK1093-3xxx-xxxx	EtherCAT cable M8, yellow	<a href="#">Website</a>
ZK2000-8xxx-xxxx	Sensor cable M12, 8-pin	<a href="#">Website</a>
ZK2020-3xxx-xxxx	Power cable M8, 4-pin	<a href="#">Website</a>

### Tools

Ordering information	Description
ZB8801-0000	Torque wrench for plugs, 0.4...1.0 Nm
ZB8801-0001	Torque cable key for M8 / wrench size 9 for ZB8801-0000
ZB8801-0002	Torque cable key for M12 / wrench size 13 for ZB8801-0000
ZB8801-0003	Torque cable key for M12 field assembly / wrench size 18 for ZB8801-0000

#### **i** Further accessories

Further accessories can be found in the price list for fieldbus components from Beckhoff and online at <https://www.beckhoff.com>.

## 7.3 Version identification of EtherCAT devices

### 7.3.1 General notes on marking

#### Designation

A Beckhoff EtherCAT device has a 14-digit designation, made up of

- family key
- type
- version
- revision

Example	Family	Type	Version	Revision
EL3314-0000-0016	EL terminal 12 mm, non-pluggable connection level	3314 4-channel thermocouple terminal	0000 basic type	0016
ES3602-0010-0017	ES terminal 12 mm, pluggable connection level	3602 2-channel voltage measurement	0010 high-precision version	0017
CU2008-0000-0000	CU device	2008 8-port fast ethernet switch	0000 basic type	0000

#### Notes

- The elements mentioned above result in the **technical designation**. EL3314-0000-0016 is used in the example below.
- EL3314-0000 is the order identifier, in the case of “-0000” usually abbreviated to EL3314. “-0016” is the EtherCAT revision.
- The **order identifier** is made up of
  - family key (EL, EP, CU, ES, KL, CX, etc.)
  - type (3314)
  - version (-0000)
- The **revision** -0016 shows the technical progress, such as the extension of features with regard to the EtherCAT communication, and is managed by Beckhoff.  
 In principle, a device with a higher revision can replace a device with a lower revision, unless specified otherwise, e.g. in the documentation.  
 Associated and synonymous with each revision there is usually a description (ESI, EtherCAT Slave Information) in the form of an XML file, which is available for download from the Beckhoff web site.  
 From 2014/01 the revision is shown on the outside of the IP20 terminals, see Fig. “EL5021 EL terminal, standard IP20 IO device with batch number and revision ID (since 2014/01)”.
- The type, version and revision are read as decimal numbers, even if they are technically saved in hexadecimal.

### 7.3.2 Version identification of IP67 modules

The serial number/ data code for Beckhoff IO devices is usually the 8-digit number printed on the device or on a sticker. The serial number indicates the configuration in delivery state and therefore refers to a whole production batch, without distinguishing the individual modules of a batch.

Structure of the serial number: **KK YY FF HH**

KK - week of production (CW, calendar week)

YY - year of production

FF - firmware version

HH - hardware version

Example with serial number 12 06 3A 02:

12 - production week 12

06 - production year 2006

3A - firmware version 3A

02 - hardware version 02

Exceptions can occur in the **IP67 area**, where the following syntax can be used (see respective device documentation):

Syntax: D ww yy x y z u

D - prefix designation

ww - calendar week

yy - year

x - firmware version of the bus PCB

y - hardware version of the bus PCB

z - firmware version of the I/O PCB

u - hardware version of the I/O PCB

Example: D.22081501 calendar week 22 of the year 2008 firmware version of bus PCB: 1 hardware version of bus PCB: 5 firmware version of I/O PCB: 0 (no firmware necessary for this PCB) hardware version of I/O PCB: 1

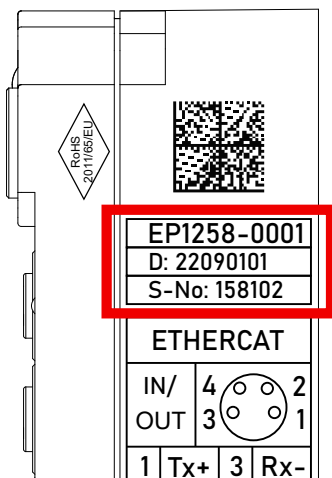

Fig. 21: EP1258-00001 IP67 EtherCAT Box with batch number/DateCode 22090101 and unique serial number 158102

### 7.3.3 Beckhoff Identification Code (BIC)

The Beckhoff Identification Code (BIC) is increasingly being applied to Beckhoff products to uniquely identify the product. The BIC is represented as a Data Matrix Code (DMC, code scheme ECC200), the content is based on the ANSI standard MH10.8.2-2016.

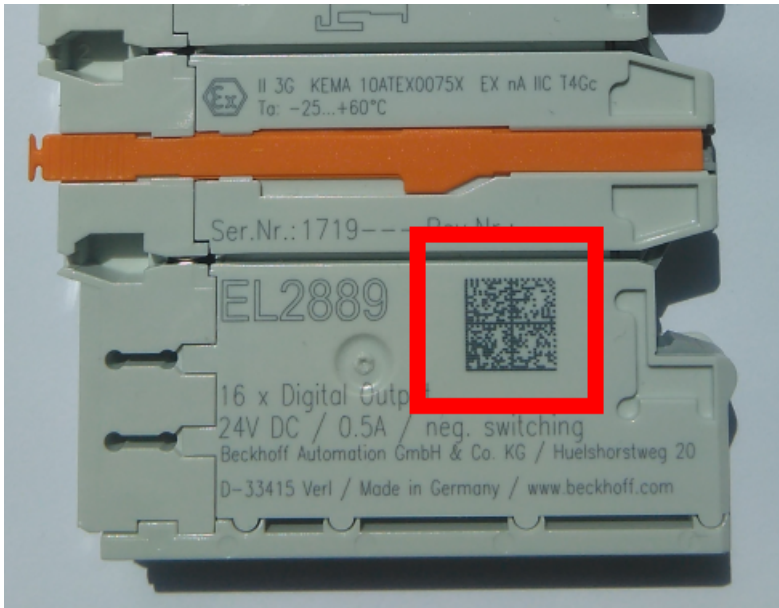

Fig. 22: BIC as data matrix code (DMC, code scheme ECC200)

The BIC will be introduced step by step across all product groups.

Depending on the product, it can be found in the following places:

- on the packaging unit
- directly on the product (if space suffices)
- on the packaging unit and the product

The BIC is machine-readable and contains information that can also be used by the customer for handling and product management.

Each piece of information can be uniquely identified using the so-called data identifier (ANSI MH10.8.2-2016). The data identifier is followed by a character string. Both together have a maximum length according to the table below. If the information is shorter, spaces are added to it.

Following information is possible, positions 1 to 4 are always present, the other according to need of production:

Position	Type of information	Explanation	Data identifier	Number of digits incl. data identifier	Example
1	Beckhoff order number	<b>Beckhoff order number</b>	1P	8	<b>1P</b> 072222
2	Beckhoff Traceability Number (BTN)	<b>Unique serial number, see note below</b>	SBTN	12	<b>S</b> BTNk4p562d7
3	Article description	<b>Beckhoff article description, e.g. EL1008</b>	1K	32	<b>1K</b> EL1809
4	Quantity	<b>Quantity in packaging unit, e.g. 1, 10, etc.</b>	Q	6	<b>Q</b> 1
5	Batch number	Optional: Year and week of production	2P	14	<b>2P</b> 401503180016
6	ID/serial number	Optional: Present-day serial number system, e.g. with safety products	51S	12	<b>51S</b> 678294
7	Variant number	Optional: Product variant number on the basis of standard products	30P	32	<b>30P</b> F971, 2*K183
...					

Further types of information and data identifiers are used by Beckhoff and serve internal processes.

### Structure of the BIC

Example of composite information from positions 1 to 4 and with the above given example value on position 6. The data identifiers are highlighted in bold font:

**1P**072222**S**BTNk4p562d7**1K**EL1809 **Q**1 **51S**678294

Accordingly as DMC:



Fig. 23: Example DMC **1P**072222**S**BTNk4p562d7**1K**EL1809 **Q**1 **51S**678294

### BTN

An important component of the BIC is the Beckhoff Traceability Number (BTN, position 2). The BTN is a unique serial number consisting of eight characters that will replace all other serial number systems at Beckhoff in the long term (e.g. batch designations on IO components, previous serial number range for safety products, etc.). The BTN will also be introduced step by step, so it may happen that the BTN is not yet coded in the BIC.

### NOTICE

This information has been carefully prepared. However, the procedure described is constantly being further developed. We reserve the right to revise and change procedures and documentation at any time and without prior notice. No claims for changes can be made from the information, illustrations and descriptions in this information.



### 7.3.4 Electronic access to the BIC (eBIC)

#### Electronic BIC (eBIC)

The Beckhoff Identification Code (BIC) is applied to the outside of Beckhoff products in a visible place. If possible, it should also be electronically readable.

The interface that the product can be electronically addressed by is crucial for the electronic readout.

#### EtherCAT devices (IP20, IP67)

All Beckhoff EtherCAT devices have an ESI-EEPROM which contains the EtherCAT identity with the revision number. The EtherCAT slave information, also colloquially known as the ESI/XML configuration file for the EtherCAT master, is stored in it. See the corresponding chapter in the EtherCAT system manual ([Link](#)) for the relationships.

Beckhoff also stores the eBIC in the ESI-EEPROM. The eBIC was introduced into Beckhoff IO production (terminals, box modules) in 2020; as of 2023, implementation is largely complete.

The user can electronically access the eBIC (if present) as follows:

- With all EtherCAT devices, the EtherCAT master (TwinCAT) can read the eBIC from the ESI-EEPROM
  - From TwinCAT 3.1 build 4024.11, the eBIC can be displayed in the online view.
  - To do this, check the "Show Beckhoff Identification Code (BIC)" checkbox under EtherCAT → Advanced Settings → Diagnostics:

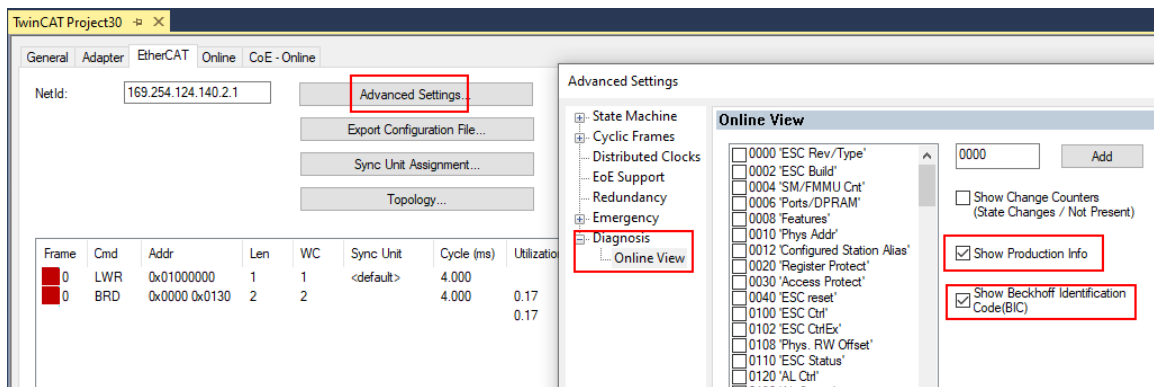

- The BTN and its contents are then displayed:

No	Addr	Name	State	CRC	Fw	Hw	Production Data	ItemNo	BTN	Description	Quantity	BatchNo	SerialNo
1	1001	Term 1 (EK1100)	OP	0,0	0	0	---						
2	1002	Term 2 (EL1018)	OP	0,0	0	0	2020 KW36 Fr	072222	k4p562d7	EL1809	1		678294
3	1003	Term 3 (EL3204)	OP	0,0	7	6	2012 KW24 Sa						
4	1004	Term 4 (EL2004)	OP	0,0	0	0	---	072223	k4p562d7	EL2004	1		678295
5	1005	Term 5 (EL1008)	OP	0,0	0	0	---						
6	1006	Term 6 (EL2008)	OP	0,0	0	12	2014 KW14 Mo						
7	1007	Term 7 (EK1110)	OP	0	1	8	2012 KW25 Mo						

- Note: As shown in the figure, the production data HW version, FW version, and production date, which have been programmed since 2012, can also be displayed with "Show production info".
- Access from the PLC: From TwinCAT 3.1. build 4024.24, the functions *FB\_EcReadBIC* and *FB\_EcReadBTN* for reading into the PLC are available in the Tc2\_EtherCAT library from v3.3.19.0.
- EtherCAT devices with a CoE directory may also have the object 0x10E2:01 to display their own eBIC, which can also be easily accessed by the PLC:

- The device must be in PREOP/SAFEOP/OP for access:

Index	Name	Flags	Value
1000	Device type	RO	0x015E1389 (22942601)
1008	Device name	RO	ELM3704-0000
1009	Hardware version	RO	00
100A	Software version	RO	01
100B	Bootloader version	RO	J0.1.27.0
1011:0	Restore default parameters	RO	> 1 <
1018:0	Identity	RO	> 4 <
10E2:0	Manufacturer-specific Identification C...	RO	> 1 <
10E2:01	SubIndex 001	RO	1P158442SBTN0008jckp1KELM3704 Q1 2P482001000016
10F0:0	Backup parameter handling	RO	> 1 <
10F3:0	Diagnosis History	RO	> 21 <
10F8	Actual Time Stamp	RO	0x170bfb277e

- The object 0x10E2 will be preferentially introduced into stock products in the course of necessary firmware revision.
- From TwinCAT 3.1. build 4024.24, the functions *FB\_EcCoEReadBIC* and *FB\_EcCoEReadBTN* for reading into the PLC are available in the *Tc2\_EtherCAT* library from v3.3.19.0
- The following auxiliary functions are available for processing the BIC/BTN data in the PLC in *Tc2\_Uilities* as of TwinCAT 3.1 build 4024.24
  - *F\_SplitBIC*: The function splits the Beckhoff Identification Code (BIC) *sBICValue* into its components using known identifiers and returns the recognized substrings in the *ST\_SplittedBIC* structure as a return value
  - *BIC\_TO\_BTN*: The function extracts the BTN from the BIC and returns it as a return value
- Note: If there is further electronic processing, the BTN is to be handled as a string(8); the identifier "SBTN" is not part of the BTN.
- Technical background  
The new BIC information is written as an additional category in the ESI-EEPROM during device production. The structure of the ESI content is largely dictated by the ETG specifications, therefore the additional vendor-specific content is stored using a category in accordance with the ETG.2010. ID 03 tells all EtherCAT masters that they may not overwrite these data in the event of an update or restore the data after an ESI update.  
The structure follows the content of the BIC, see here. The EEPROM therefore requires approx. 50..200 bytes of memory.
- Special cases
  - If multiple hierarchically arranged ESCs are installed in a device, only the top-level ESC carries the eBIC information.
  - If multiple non-hierarchically arranged ESCs are installed in a device, all ESCs carry the eBIC information.
  - If the device consists of several sub-devices which each have their own identity, but only the top-level device is accessible via EtherCAT, the eBIC of the top-level device is located in the CoE object directory 0x10E2:01 and the eBICs of the sub-devices follow in 0x10E2:nn.

## 7.4 Support and Service

Beckhoff and their partners around the world offer comprehensive support and service, making available fast and competent assistance with all questions related to Beckhoff products and system solutions.

### Beckhoff's branch offices and representatives

Please contact your Beckhoff branch office or representative for local support and service on Beckhoff products!

The addresses of Beckhoff's branch offices and representatives round the world can be found on her internet pages: [www.beckhoff.com](http://www.beckhoff.com)

You will also find further documentation for Beckhoff components there.

### Support

The Beckhoff Support offers you comprehensive technical assistance, helping you not only with the application of individual Beckhoff products, but also with other, wide-ranging services:

- support
- design, programming and commissioning of complex automation systems
- and extensive training program for Beckhoff system components

Hotline: +49 5246 963 157  
e-mail: [support@beckhoff.com](mailto:support@beckhoff.com)  
web: [www.beckhoff.com/support](http://www.beckhoff.com/support)

### Service

The Beckhoff Service Center supports you in all matters of after-sales service:

- on-site service
- repair service
- spare parts service
- hotline service

Hotline: +49 5246 963 460  
e-mail: [service@beckhoff.com](mailto:service@beckhoff.com)  
web: [www.beckhoff.com/service](http://www.beckhoff.com/service)

### Headquarters Germany

Beckhoff Automation GmbH & Co. KG

Hülshorstweg 20  
33415 Verl  
Germany

Phone: +49 5246 963 0  
e-mail: [info@beckhoff.com](mailto:info@beckhoff.com)  
web: [www.beckhoff.com](http://www.beckhoff.com)



Beckhoff Automation GmbH & Co. KG  
Hülshorstweg 20  
33415 Verl  
Germany  
Phone: +49 5246 9630  
[info@beckhoff.com](mailto:info@beckhoff.com)  
[www.beckhoff.com](http://www.beckhoff.com)