



Installation- and Operating instructions for

CU8803-0000

CP-Link 4 transmitter box – The One Cable Display Link

Version: 1.1

Date: 2015-08-27

BECKHOFF

Table of contents

1	Foreword	3
1.1	Notes on the Documentation	3
1.1.1	Liability Conditions	3
1.1.2	Trademarks	3
1.1.3	Patent Pending	3
1.1.4	Copyright	3
1.1.5	State at Delivery	3
1.1.6	Delivery conditions	3
1.2	Description of safety symbols	4
1.3	Operator's obligation to exercise diligence	4
2	Product Description	5
2.1	Product Overview	5
2.2	Connections	6
2.2.1	Power Supply (X40)	6
2.2.2	USB Input (X10)	6
2.2.3	DVI Input (X20)	7
2.2.4	CP-Link 4 Output (X30)	7
2.3	LED-Diagnostics	8
3	Installation	9
3.1	Transport and Unpacking	9
3.1.1	Transport	9
3.1.2	Unpacking	9
3.2	Mounting/ Demounting	10
3.3	Connecting devices	11
3.3.1	Connecting cables	11
3.3.2	Connecting Power Supply	11
4	Operation	12
4.1	CP-Link 4 Architecture Description	12
4.2	Maintenance	12
4.2.1	Cleaning	12
4.2.2	Maintenance	12
4.3	Shutting down	12
4.3.1	Disposal	12
5	Dimensions	13
6	Technical Data	14
7	Appendix	15

7.1	Beckhoff Support and Service	15
7.1.1	Beckhoff branches and partner companies	15
7.1.2	Beckhoff company headquarters	15
7.2	Approvals for USA and Canada	16
7.3	FCC Approval for USA	16
7.4	FCC Approval for Canada	16

1 Foreword

1.1 Notes on the Documentation

This description is only intended for the use of trained specialists in control and automation engineering who are familiar with the applicable national standards. It is essential that the following notes and explanations are followed when installing and commissioning these components.

The responsible staff must ensure that the application or use of the products described satisfy all the requirements for safety, including all the relevant laws, regulations, guidelines and standards.

1.1.1 Liability Conditions

The documentation has been prepared with care. The products described are, however, constantly under development. For that reason the documentation is not in every case checked for consistency with performance data, standards or other characteristics. In the event that it contains technical or editorial errors, we retain the right to make alterations at any time and without warning. No claims for the modification of products that have already been supplied may be made on the basis of the data, diagrams and descriptions in this documentation.

All pictures shown in the documentation are exemplary. Illustrated configurations can differ from standard.

1.1.2 Trademarks

Beckhoff®, TwinCAT®, EtherCAT®, Safety over EtherCAT®, TwinSAFE® and XFC® are registered trademarks of and licensed by Beckhoff Automation GmbH.

Other designations used in this publication may be trademarks whose use by third parties for their own purposes could violate the rights of the owners.

1.1.3 Patent Pending

The EtherCAT Technology is covered, including but not limited to the following patent applications and patents: EP1590927, EP1789857, DE102004044764, DE102007017835 with corresponding applications or registrations in various other countries.

The TwinCAT Technology is covered, including but not limited to the following patent applications and patents: EP0851348, US6167425 with corresponding applications or registrations in various other countries.

1.1.4 Copyright

© Beckhoff Automation GmbH & Co. KG.

The reproduction, distribution and utilization of this document as well as the communication of its contents to others without express authorization are prohibited. Offenders will be held liable for the payment of damages. All rights reserved in the event of the grant of a patent, utility model or design.

1.1.5 State at Delivery





All the components are supplied in particular hardware and software configurations appropriate for the application. Modifications to hardware or software configurations other than those described in the documentation are not permitted, and nullify the liability of Beckhoff Automation GmbH & Co. KG.

1.1.6 Delivery conditions

In addition, the general delivery conditions of the company Beckhoff Automation GmbH & Co. KG apply.

1.2 Description of safety symbols

The following safety symbols are used in this operating manual. They are intended to alert the reader to the associated safety instructions.

 DANGER	<p>Acute risk of injury!</p> <p>If you do not adhere the safety advise adjoining this symbol, there is immediate danger to life and health of individuals!</p>
 WARNING	<p>Risk of injury!</p> <p>If you do not adhere the safety advise adjoining this symbol, there is danger to life and health of individuals!</p>
 CAUTION	<p>Hazard to individuals!</p> <p>If you do not adhere the safety advise adjoining this symbol, there is obvious hazard to individuals!</p>
 Attention	<p>Hazard to devices and environment</p> <p>If you do not adhere the notice adjoining this symbol, there is obvious hazard to materials and environment.</p>
 Note	<p>Note or pointer</p> <p>This symbol indicates information that contributes to better understanding.</p>

1.3 Operator's obligation to exercise diligence

The operator must ensure that

- the product is only used as intended (see chapter [Product Description](#))
- the product is in a sound condition and in working order during operation (see chapter [Maintenance](#))
- the product is operated, maintained and repaired only by suitably qualified and authorized personnel
- the personnel is instructed regularly about relevant occupational safety and environmental protection aspects, and is familiar with the operating manual and in particular the safety notes contained herein
- the operation manual is in good condition and complete, and always available for reference at the location of the product
- none of the safety and warning notes attached to product are removed, and that all notes remain legible.

2 Product Description

2.1 Product Overview



The CP29xx-0010 multi-touch built-in panels and the CP39xx-0010 multi-touch panels for mounting arm installation can be operated up to 100 m away from the PC. CP-Link 4 – The One Cable Display Link – transfers DVI and USB together via a Cat.6_A cable. The CU8803 CP-Link 4 transmitter box is connected to the PC via DVI and USB. The power supply for the Control Panel can also be provided via CP-Link 4. The power supply socket of the panel is not used.

Other outstanding features are:

- 1 USB input with USB B socket to be connected to the PC in 1 m distance
- 1 DVI input with DVI-D socket to be connected to the PC in 1 m distance
- 1 CP-Link 4 output with RJ45 socket for up to 100 m Cat.6_A cable for connecting a Control Panel with CP-Link 4 interface CP29xx-0010 or CP39xx-0010
- Power supply of the Control Panel with CU8803 via the Cat.6_A cable
- Metal housing for DIN rail installation
- CP-Link 4 transfers USB 2.0 with 100 Mbit/s and DVI
- 24 V input for power supply of the CU8803 transmitter box and the Control Panel
- Protection class IP 20.

2.2 Connections

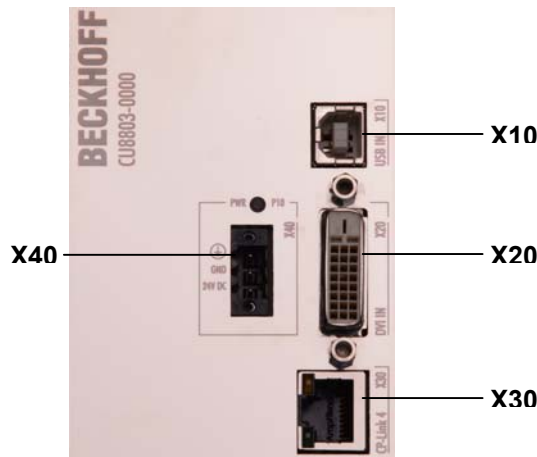

2.2.1 Power Supply (X40)



X40

SLWA 1x 3pole RM3.5 THR Omnimate SL-SMT3.5/3/90LF 1.5SN sw Weidmueller 180495 0000

The power supply for the CU8803-0000 transmitter box and the protective earthing connection is established via the 3-pole socket (**X40**).

One 3-pole power supply connector is provided with the transmitter box, the pin assignment is shown at the imprint beside the connector. The low resistance protective earthing connection is established via the ground pin.



Note

Malfunction possible with missing ground connection

A proper ground connection of the device is absolutely necessary for the correct function of the touchscreen.

2.2.2 USB Input (X10)

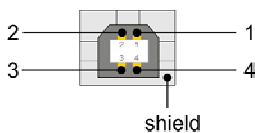

X10

Connector USB TYP-B LP-mount. WS

The CP-Link 4 transmitter box CU8803-0000 is connected with the Industrial PC via the USB input (**X10**). The maximum cable length is 1 m.

Pin	Signal	Pin	Signal
1	VCC	4	GND
2	Data -	Shield	Shield
3	Data+		

2.2.3 DVI Input (X20)

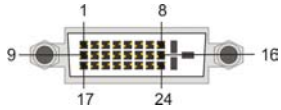

X20

Connector DVI-D 3x8pole Digital LP-mount.

The CP-Link 4 transmitter box CU8803-0000 is connected with the Industrial PC via the DVI input (**X20**). The maximum cable length is 1 m.

Pin	Signal	Pin	Signal
1	TMDS Data 2-	13	n.c.
2	TMDS Data 2+	14	+ 5 V Power Supply
3	TMDS Data2/4 shield	15	GND (+5 V, Analog H/V Sync)
4	n.c.	16	Hot Plug Detect
5	n.c.	17	TMDS Data 0 -
6	DDC Clock	18	TMDS Data 0 +
7	DDC Data	19	TMDS Data 0/5 shield
8	Analog Vertical Sync	20	n.c.
9	TMDS Data 1 -	21	n.c.
10	TMDS Data 1 +	22	TMDS Clock shield
11	TMDS Data1/3 shield	23	TMDS Clock +
12	n.c.	24	TMDS Clock -

2.2.4 CP-Link 4 Output (X30)

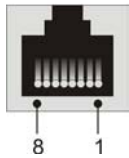

X30

BA 1x8pole RJ45 Invers shield 2XLWL Lp-mount. Molex Nr: 43860-0016 Modular Jack

The CP-Link 4 transmitter box CU8803-0000 is connected with the Control Panel via the CP-Link 4 output (**X30**).

Pin	Signal	Pin	Signal
1	CP-Link4_0P	5	CP-Link4_2N
2	CP-Link4_0N	6	CP-Link4_1N
3	CP-Link4_1P	7	CP-Link4_3P
4	CP-Link4_2P	8	CP-Link4_3N

 Attention	<p>CU8803-0000 disconnect power supply</p> <p>If using the CP-Link 4 - One Cable Display Link, the 24 V power supply of the CP-Link 4 transmitter box must be switched off before disconnecting the CP-Link 4 output connection.</p>
----------------------	---------------------------------------------------------------------------------------------------------------------------------------------------------------------------------------------------------------------------------------------

2.3 LED-Diagnostics

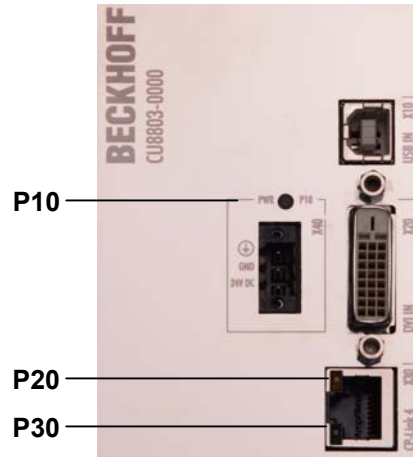

LED	Allocation	State	Meaning
P10	Power supply	off	no power supply
		lights green	24 V _{DC} connected
P20	Connection	off	no connection to the Control Panel
		lights green	connection to the Control Panel established
P30	Activity	off	no image data transmission
		flashes yellow	DVI data transmission

3 Installation

3.1 Transport and Unpacking

The specified storage conditions must be observed (see chapter [Technical Data](#)).

3.1.1 Transport

Despite the robust design of the unit, the components are sensitive to strong vibrations and impacts. During transport, the unit should therefore be protected from excessive mechanical stress. Therefore, please use the original packaging.

 Attention	Danger of damage to the unit If the device is transported in cold weather or is exposed to extreme variations in temperature, make sure that moisture (condensation) does not form on or inside the device.
-------------------------------------------------------------------------------------------------------	-----------------------------------------------------------------------------------------------------------------------------------------------------------------------------------------------------------------------

Prior to operation, the unit must be allowed to slowly adjust to room temperature. Should condensation occur, a delay time of approximately 12 hours must be allowed before the unit is switched on.

3.1.2 Unpacking

Proceed as follows to unpack the unit:

1. Remove packaging
2. Do not discard the original packaging. Keep it for future relocation
3. Check the delivery for completeness by comparing it with your order
4. Please keep the associated paperwork. It contains important information for handling the unit
5. Check the contents for visible shipping damage.

If you notice any shipping damage or inconsistencies between the contents and your order, you should notify Beckhoff Service.



3.2 Mounting/ Demounting

The CP-Link 4 transmitter box CU8803-0000 can be snapped onto a 35 mm mounting rail conforms to EN 50022:



To release the CP-Link 4 transmitter box CU8803-0000 from the mounting rail, press the device downwards till you can remove it from the rail.

3.3 Connecting devices

 Attention	<p>The power supply plug must be withdrawn</p> <p>Please read the documentation for the external devices prior to connecting them!</p> <p>During thunderstorms, plug connector must neither be inserted nor removed!</p> <p>When disconnecting a plug connector, always handle it at the plug. Do not pull the cable!</p>
 Attention	<p>CU8803-0000 disconnect power supply</p> <p>If using the CP-Link 4 - One Cable Display Link , the 24 V power supply of the CP-Link 4 transmitter box must be switched off before disconnecting the CP-Link 4 output connection.</p>

3.3.1 Connecting cables

The connections are documented in the section [Product Description](#).

When connecting the cables to the CU8803-0000, proceed according to the following sequence:

- Switch off all the devices that are to be connected
- Disconnect all the devices that are to be connected from the power supply
- Connect all the cables between the CU8803-0000 and the devices that are to be connected
- Reconnect all devices to the power supply.

3.3.2 Connecting Power Supply

1. Check that the external power supply is providing the correct voltage.
2. Connect the unit to your external 24 V_{DC} power supply.

4 Operation

4.1 CP-Link 4 Architecture Description

The CP29xx-0010 multi-touch built-in panels and the CP39xx-0010 multi-touch panels for mounting arm installation can be operated up to 100 m away from the PC. CP-Link 4 – The One Cable Display Link – transfers DVI and USB together via a Cat.6_A cable. The CU8803 transmitter box provides power to the Control Panel via the Cat.6_A cable, which also transfers DVI and USB. The power supply socket of the panel is not used.

The maximum cable lengths for DVI- and USB connection are 1 m.

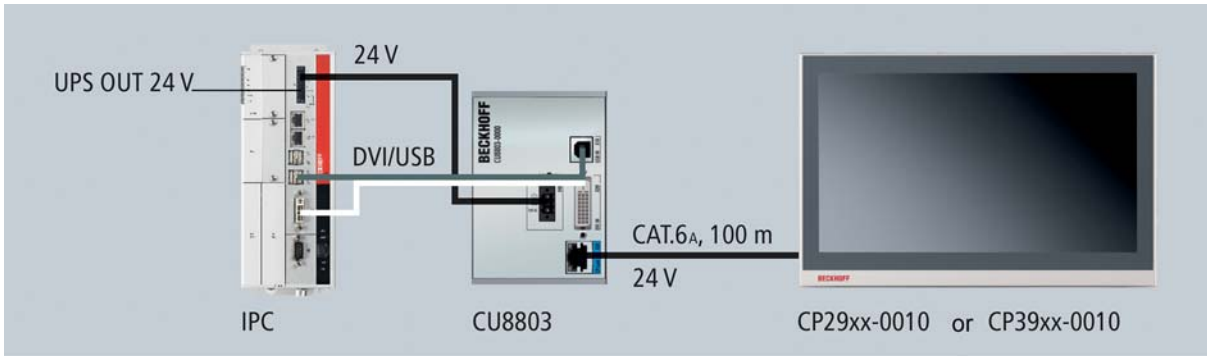

4.2 Maintenance

4.2.1 Cleaning

 DANGER	<p>Disconnect power supply</p> <p>Switch off the device and all connected devices, and disconnect the device from the power supply.</p>
------------------------------------------------------------------------------------------------------	------------------------------------------------------------------------------------------------------------------------------------------------

The device can be cleaned with a soft, damp cloth. Do not use any aggressive cleaning materials, thinners, scouring material or hard objects that could cause scratches.

4.2.2 Maintenance

The CU8803-0000 CP-Link 4 transmitter box is maintenance-free.

4.3 Shutting down

4.3.1 Disposal

 Note	<p>Observe national electronics scrap regulations</p> <p>Observe the national electronics scrap regulations when disposing of the device.</p>
----------------------------------------------------------------------------------------------------	------------------------------------------------------------------------------------------------------------------------------------------------------

In order to dispose of the device, it must be removed and fully dismantled:

- Housing components (polycarbonate, polyamide (PA6.6)) are suitable for plastic recycling
- Metal parts can be sent for metal recycling
- Electronic parts such as disk drives and circuit boards must be disposed of in accordance with national electronics scrap regulations.

5 Dimensions

The product is characterized by small overall installed size. With a height of 100 mm, the module dimensions exactly match those of the Beckhoff Bus Terminals. Together with the lowered connector surfaces, this means that it can be used in a standard terminal box with a height of 120 mm.

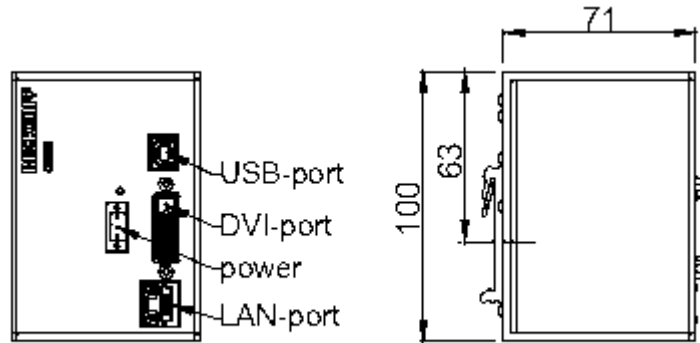

front view

left view

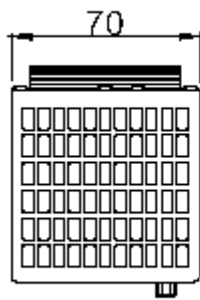

top view

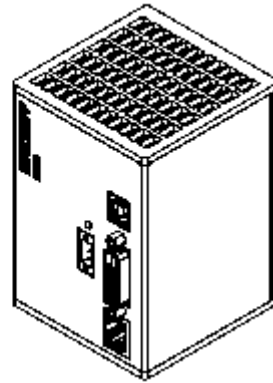

6 Technical Data

Product name	CU8803-0000
Inputs	1 USB input with USB B socket to be connected to the PC
	1 DVI input with DVI-D socket to be connected to the PC
Output	1 CP-Link 4 output with RJ45 socket for Cat.6 _A cable for connecting a Control Panel with CP-Link 4 interface CP29xx-0010 or CP39xx-0010
USB wiring length	maximum 1 meter
DVI wiring length	maximum 1 meter
CP-Link 4 output wiring length	maximum 100 meters
Supported baud rates USB	100 Mbit/ s
Power Supply	24 V _{DC} (-15% to +20%), protected against polarity reversal. To meet the UL requirements use 4 A fuse or class 2 power supply!
max. current consumption with Control Panel	app. 4.7 A
Dimensions (W x H x D)	app. 70 mm x 100 mm x 80 mm
Weight	app. 745 g
Permissible ambient temperature	0°C to +55°C (operation) -25°C to +70°C (transport/ storage)
Permissible relative humidity	5% to 95%, no condensation
EMC resistance burst / ESD	EN 60000-6-2 / EN 60000-6-4
Vibration / Shock resistance	EN 60068-2-6 / EN 60068-2-27
Assembly	on 35 mm mounting rail conforms to EN 50022
Installation position	any
Protection class	IP20
Approvals	CE, UL (in preparation)

7 Appendix

7.1 Beckhoff Support and Service

Beckhoff and their partners around the world offer comprehensive support and service, making available fast and competent assistance with all questions related to Beckhoff products and system solutions.

7.1.1 Beckhoff branches and partner companies

Please contact your Beckhoff branch office or partner company for [local support and service](#) on Beckhoff products!

The contact addresses for your country can be found in the list of Beckhoff branches and partner companies: www.beckhoff.com. You will also find further [documentation](#) for Beckhoff components there.

7.1.2 Beckhoff company headquarters

Beckhoff Automation GmbH & Co. KG
Huelshorstweg 20
33415 Verl
Germany

Phone: + 49 (0) 5246/963-0
Fax: + 49 (0) 5246/963-198
E-mail: info@beckhoff.de
Web: <http://www.beckhoff.de/>

Beckhoff Support

Support offers you comprehensive technical assistance, helping you not only with the application of individual Beckhoff products, but also with other, wide-ranging services:

- world-wide support
- design, programming and commissioning of complex automation systems
- and extensive training program for Beckhoff system components

Hotline: + 49 (0) 5246/963-157
Fax: + 49 (0) 5246/963-9157
E-mail: support@beckhoff.com

Beckhoff Service

The Beckhoff Service Center supports you in all matters of after-sales service:

- on-site service
- repair service
- spare parts service
- hotline service

Hotline: + 49 (0) 5246/963-460
Fax: + 49 (0) 5246/963-479
E-mail: service@beckhoff.com

If servicing is required, please quote the **project number** of your product.

7.2 Approvals for USA and Canada

7.3 FCC Approval for USA

FCC: Federal Communications Commission Radio Frequency Interference Statement

This equipment has been tested and found to comply with the limits for a Class A digital device, pursuant to Part 15 of the FCC Rules. These limits are designed to provide reasonable protection against harmful interference when the equipment is operated in a commercial environment. This equipment generates, uses, and can radiate radio frequency energy and, if not installed and used in accordance with the instruction manual, may cause harmful interference to radio communications. Operation of this equipment in a residential area is likely to cause harmful interference in which case the user will be required to correct the interference at his own expense.

**Note****Technical modifications**

Technical modifications to the device may cause the loss of the FCC approval.

7.4 FCC Approval for Canada

FCC: Canadian Notice

This equipment does not exceed the Class A limits for radiated emissions as described in the Radio Interference Regulations of the Canadian Department of Communications.