



Installation and Operating instructions for **Built-in Industrial PC C6525**

Version: 1.0
Date: 2008-11-03

BECKHOFF

Table of contents

1. General Notes	3
Notes on the Documentation	3
Liability Conditions	3
Description of safety symbols	3
Basic safety measures	4
Operator's obligation to exercise diligence	5
Operator requirements	5
2. Product Description	6
Appropriate Use	6
Access to the Hard Disk, the CF-Slot and the Battery	6
Interfaces	7
Serial interface	7
DVI (Digital Visual Interface)	7
USB-Interfaces	7
Network connection	7
Power Supply	7
Additional plug-in cards (optional)	7
Ground connection	7
3. Installation Instructions	8
Transport and Unpacking	8
Transport	8
Unpacking	8
Installation of the PC in the control cabinet	9
Earthing measures	9
Mounting of the Industrial PC	10
Power Supply Connection	11
Beckhoff power supply technology	11
Pin assignment of the connector	12
Fitting the cable	13
Material for assembling the connectors	13
Assembling the connectors	13
Connecting Power Supply	14
Cable Cross Sections	14
Configuration for shutting down the PC	14
PC_ON and Power Status functions	14
UPS output	14
UPS output function	14
Wiring diagram	15
Connecting devices	16
Connecting cables	16
Check voltage rating and connect	16
Fastening the cables	16
4. Operating Instructions	17
Switching the Industrial PC on and off	17
First switching on and driver installation	17
Maintenance	18
Cleaning the Industrial PC	18
Replacing the battery on the motherboard	18
Servicing	18
Shutting down	18
Disposal	18
5. UPS Software Components (optional)	19
Installation on the PC	19
Help files	19

6. Troubleshooting	20
Fault correction	20
Beckhoff Support & Service	21
Beckhoff branches and partner companies	21
Beckhoff Headquarters	21
Beckhoff Support	21
Beckhoff Service	21
7. Assembly dimensions	22
8. Appendix	23
Technical data	23
Approvals	23
FCC: Federal Communications Commission Radio Frequency Interference Statement	23
FCC: Canadian Notice	23

General Notes

Notes on the Documentation

This description is only intended for the use of trained specialists in control and automation engineering who are familiar with the applicable national standards. It is essential that the following notes and explanations are followed when installing and commissioning these components.

Liability Conditions

The responsible staff must ensure that the application or use of the products described satisfy all the requirements for safety, including all the relevant laws, regulations, guidelines and standards.

The documentation has been prepared with care. The products described are, however, constantly under development. For that reason the documentation is not in every case checked for consistency with performance data, standards or other characteristics. None of the statements of this manual represents a guarantee (Garantie) in the meaning of § 443 BGB of the German Civil Code or a statement about the contractually expected fitness for a particular purpose in the meaning of § 434 par. 1 sentence 1 BGB. In the event that it contains technical or editorial errors, we retain the right to make alterations at any time and without warning. No claims for the modification of products that have already been supplied may be made on the basis of the data, diagrams and descriptions in this documentation.

© This documentation is copyrighted. Any reproduction or third party use of this publication, whether in whole or in part, without the written permission of Beckhoff Automation GmbH, is forbidden.

Description of safety symbols

The following safety symbols are used in this operating manual. They are intended to alert the reader to the associated safety instructions.



This symbol is intended to highlight risks for the life or health of personnel.



This symbol is intended to highlight risks for equipment, materials or the environment.



This symbol indicates information that contributes to better understanding.

Basic safety measures

Only switch the PC off after closing the software

Before the Industrial PC is switched off, software that is running must be properly closed.

Otherwise it is possible that data on the hard disk is lost. Please read the section on [Switching the Industrial PC on and off](#).



Warning

Switch off all parts of the equipment, then uncouple the fieldbus!

Before opening the housing of the PC, and whenever the PC is being used for purposes other than plant control, such as during functional tests following repair, all parts of the equipment must first be switched off, after which the Industrial PC can be uncoupled from the plant.

Pulling out the fieldbus connection plug uncouples the PC (optional).

Items of equipment that have been switched off must be secured against being switched on again.

The Industrial PC's power supply unit must be supplied with 24 V_{DC}.



Warning

Do not exchange any parts when under power!

When components are being fitted or removed, the supply voltage must be switched off.

Fitting work on the Industrial PC can result in damage:

- If metal objects such as screws or tools fall onto operating circuit boards.
- If connecting cables internal to the PC are removed or inserted during operation.
- If plug-in cards are removed or inserted when the PC is switched on.

Operator's obligation to exercise diligence

The operator must ensure that

- the Industrial PC is only used for its intended use (see also [Product Description](#) chapter).
- the Industrial PC is in a sound condition and in working order during operation.
- the operation manual is in good condition and complete, and always available for reference at the location of the Industrial PC.
- the Industrial PC is operated, maintained and repaired only by sufficiently qualified and authorized personnel.
- the personnel is instructed regularly about relevant occupational safety and environmental protection aspects, and is familiar with the operating manual and in particular the safety notes contained herein.
- none of the safety and warning notes attached to the Industrial PC are removed, and that all notes remain legible.

National regulations depending on the machine type

Depending on the type of machine and plant in which the Industrial PC is being used, there will be national regulations for the control of such machines and plant that the operator must observe. These regulations cover, amongst other things, the intervals between inspections of the controller.

The operator must initiate such inspections in good time.



Warning

Only trained persons may open the Industrial PC housing!

The operator is responsible for ensuring that only trained electrical staff opens the housing of the Industrial PC.

Procedure in the event of a fault

In the event of a fault in the Industrial PC, appropriate measures can be determined with the aid of the list in the [Fault correction](#) section.

Operator requirements

Read the operating instructions

Every user of the Industrial PC must have read these operating instructions.

Software knowledge

Every user must be familiar with any of the functions of the software installed on the PC that he can reach.

Product Description

Appropriate Use

The 6525 Industrial PC is designed for mounting in control cabinets or in the rear panel of a control or console housing for machine and plant engineering applications. The heat sink of the IPC is thereby fed to the outside through a suitable cut-out in the panel of the control cabinet. This ensures that the power dissipation of the processor and chipset is given off directly to the surroundings.

View from the top



Configuration

The 6525 is a fanless Industrial PC with passive cooling and can hence be constructed completely without rotating parts. Integrated seals provide for an IP 67 closure.

Access to the Hard Disk, the CF-Slot and the Battery

A 2½-inch SATA hard disk (optional), the CF-slot and the battery are located behind the cover plate on top of the Industrial PC.

Removing the cover plate



After loosening the two screws (1) and (2) the cover plate can be removed.

Access to the hard disk, the CF-slot and the battery

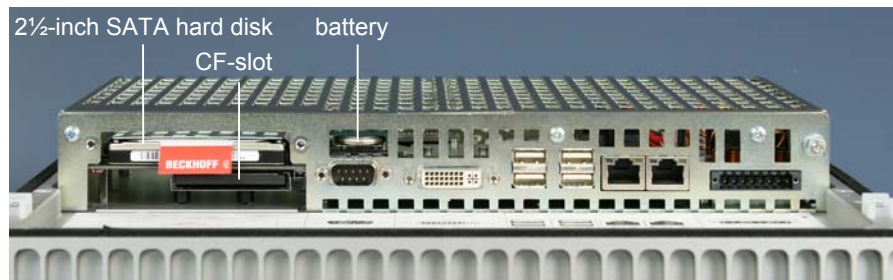

Interfaces

Interfaces to the Industrial PC

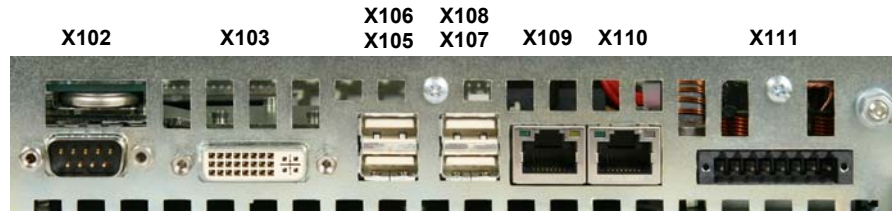

Serial interface

*RS 232
COM1*

The Industrial PC has one serial interfaces, COM1 (**X102**), using the type RS232, which is brought to a 9 pin SUB-D plug connector.

DVI (Digital Visual Interface)

DVI-I

The DVI connection (**X103**) is used for transferring the video signal. DVI-I standard is supported.

USB-Interfaces

USB1 – USB4

The four USB interfaces (**X105 – X108**) are used for connecting peripheral devices with USB connection. USB2.0 standard is supported.

Network connection

Network 10/100BASE-T

The RJ-45 connector (**X109**) allows the PC to be connected to a 10/100BASE-T Local Area Network (LAN).

*Network
10/100/1000BASE-T*

The RJ-45 connector (**X110**) allows the PC to be connected to a 10/100/1000BASE-T Local Area Network (LAN).

Power Supply

Power supply

The power supply for the Industrial PC is established via the socket (**X111**).

Additional plug-in cards (optional)

Type plate

There is a type plate on the top of the Industrial PC which provides information about the hardware configuration of the Industrial PC at the time it was supplied.

Ground connection

Ground connection



The Industrial PC is grounded via the stud bolt.

Installation Instructions

Please also refer to chapter [General Notes](#).

Transport and Unpacking

The specified storage conditions must be observed (see chapter [Technical data](#)).

Transport

Despite the robust design of the unit, the components are sensitive to strong vibrations and impacts. During transport, your Industrial PC should therefore be protected from excessive mechanical stress. Therefore, please use the original packaging.



Warning

Danger of damage to the unit!

If the device is transported in cold weather or is exposed to extreme variations in temperature, make sure that moisture (condensation) does not form on or inside the device.

Prior to operation, the unit must be allowed to slowly adjust to room temperature. Should condensation occur, a delay time of approximately 12 hours must be allowed before the unit is switched on.

Unpacking

Proceed as follows to unpack the unit:

1. Remove packaging.
2. Do not discard the original packaging. Keep it for future relocation.
3. Check the delivery for completeness by comparing it with your order.
4. Please keep the associated paperwork. It contains important information for handling the unit.
5. Check the contents for visible shipping damage.
6. If you notice any shipping damage or inconsistencies between the contents and your order, you should notify Beckhoff Service.

Installation of the PC in the control cabinet

The 6525 Industrial PC is designed for mounting in control cabinets for machine and plant engineering applications.

The ambient conditions specified for operation must be observed (see chapter [Technical data](#)).

Preparation of the control cabinet

The control cabinet must be provided with the relevant cutout (see chapter [Assembly dimensions](#)).



Note

The clearance above and below the housing must be at least 200 mm in order to ensure adequate ventilation of the PC.



Warning

Extreme environmental conditions should be avoided as far as possible. Protect the PC from dust, moisture and heat.

The ventilation slots of the PC must not be covered.

Earthing measures

Earthing measures

Earthing connections dissipate interference from external power supply cables, signal cables or cables to peripheral equipment.

Establish a low-impedance connection from the earthing point on the PC housing to the central earthing point on the control cabinet wall, in which the computer is being installed. The earthing connection is located beside the power supply connector of the Industrial PC (see chapter [Ground connection](#)).

Mounting of the Industrial PC

The Industrial PC is mounted with clamping levers.

Mounting of the Industrial PC with clamping levers

Clamping levers



For installation the Industrial PC proceed as follows:

Release clamping levers,

Insert the Industrial PC into the cutout.

Release the clamping levers with a No. 2.5 Allen key.

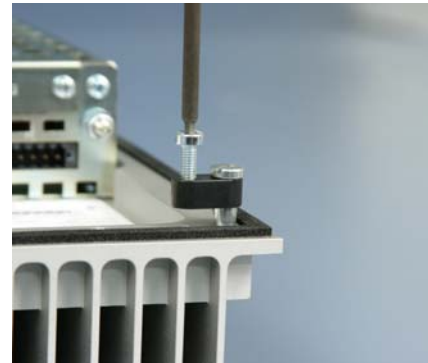

folding them out

Turn the clamping levers to the side through 90°,



and retighten them.

and retighten the screws.

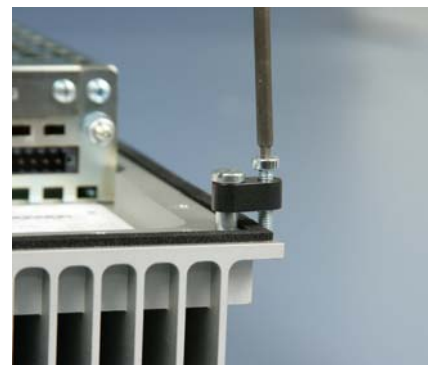

Power Supply Connection

Supplied mains power unit

The Industrial PC is fitted with a 24 V_{DC} power supply unit .



Note

When the Industrial PC is provided with a power supply unit with integrated UPS (order option) you can realize an uninterruptible power supply (UPS) using the battery pack C9900-U330.



Danger

Danger of Explosion if using other battery packs!

Beckhoff power supply technology

Schematic diagram of power supply unit wirings

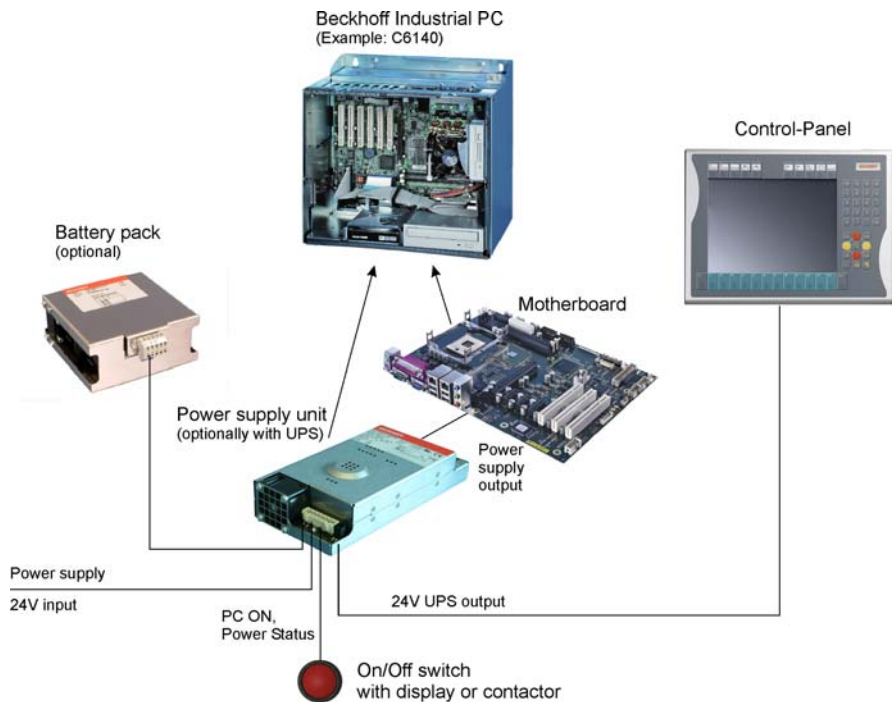

Innovative solution for shutting down Industrial PCs

Industrial PCs equipped with a UPS are in actual use frequently switched off by simply turning off the supply voltage. In this case the PC shuts down via the battery. However, over time this reduces the service life of the battery.

The new Beckhoff power supply technology approach addresses this problem and now offers the user the option of switching the PC off without the need for using the battery, thereby reducing the load on the battery.

In addition to the main switch this innovative solution uses an ON/OFF switch for the machine. Basically, the main switch remains switched on and provides the power supply for the PC during shutdown.

Once the PC has shut down, the PC power supply unit issues a signal to indicate that the process is complete and that the main voltage can be switched off. This can be done manually via a signal lamp connection or via a contactor. With this solution the main switch generally only has to be switched off if the control cabinet has to be opened.

In order to maintain a screen display for the Industrial PC in the event of a power failure, the power supply unit is equipped with a UPS output for connecting a Control Panel. This enables a power failure to be visualised and displayed to the user. Once the PC has shut down, the UPS output is switched off in order to avoid total discharge of the battery.

For a detailed functional description please refer to section [Connecting Power Supply](#).

Pin assignment of the connector

The power supply and the external circuit for switching the Industrial PC on and off are connected via the 8-pole plug connector .

Pin assignment for connecting the switch, the power supply and the battery pack (optional)



Pin	Function	
1	-	Battery Pack
2	+	(with UPS only)
3	UPS+ (Output)	
4	⊕	
5	-	24 V DC
6	+	Power Supply
7	PC_ON	
8	Power-Status	

Fitting the cable

Wiring in accordance with wiring diagram

Fit the cables for the power supply of the Industrial PC, the connection of the battery pack as well as the connection of the power-switch in accordance with the wiring diagram, using the included material for assembling the connectors.

Material for assembling the connectors

Material for assembling the connectors

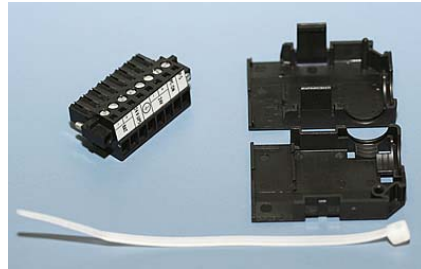

Plug connector 8-pole, Strain relief housing with lacing cord

Assembling the connectors

Conductive cross-section

The connector is specified for 16 A and can lift conductive cross-sections until 1.5 mm².

Fitting the connector to the cable

So the connector is fitted to the cable:

1. Strip insulation from the cable ends (Length of stripped conductor is 8 – 9 mm).
2. Screw together the cable ends in the 8-pole plug connector in accordance with wiring diagram.

Applying the strain relief



Thread the lacing cord into that lower part of the strain relief housing.

Putting in the plug connector

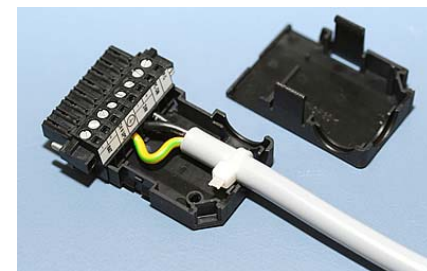

Put the plug connector into that lower part of the strain relief housing. Tighten the lacing cord and pinch off the plastic strap.

Fixing the upper part of the strain relief housing



Fix the upper part of the strain relief housing by snapping it onto the lower part.

Connecting Power Supply

The external wiring consists of the connection of the power supply, the battery pack (optional) and the connection of customised components for shutting down the PC.

Cable Cross Sections

Note cable cross sections, avoid voltage drop!

For the connection of the power supply, wiring with a cable-cross-section of 1.5 mm² must be used.

With bigger distances between voltage source and PC, you take the voltage drop as a function of the cable-cross-section as well as voltage fluctuations of your distribution voltage into account, so that is secured that the voltage doesn't fall under 22 V at the power supply.

Insert Fuse

The power supply must be protected with maximum 16 A.

Configuration for shutting down the PC

The connections for shutting down the Industrial PCs are established via the **PC_ON** input and the **Power Status** output.

PC_ON and Power Status functions

- If the **PC_ON** input is connected to 24 V via a switch, the PC shuts down according to the rules. The PC_ON signal is inverted, i.e. the PC shuts down if the 24 V connection is live.
- If the **PC_ON** input is *NOT* connected by the user, the PC can be booted in the familiar way by connecting the supply voltage and shut down via the battery by switching off the supply voltage.



Warning

This procedure significantly reduces the service life of the rechargeable battery and should therefore not be used.

- Once the PC has shut down, the **Power Status** output is switched from 24 V to 0 V. Via this output a signal lamp can be connected or a contactor for de-energising the whole system. The maximum load for the Power Status output is 0.5 A and a suitable fuse should be provided.

UPS output

In order to maintain a screen display for the PC in the event of a power failure, the power supply unit is equipped with a **UPS output** for connecting a Control Panel. The maximum load for the output is 2.0 A.

UPS output function

- The 24 V DC connection at the UPS output is live even after a power failure. The maximum load is 2.0 A.
- Once the PC has been de-energised via the UPS software, the **UPS output** is switched to 0 V. Any connected panel is thus switched off, and total discharge of the rechargeable battery is prevented.

Wiring diagram

Wiring according to the wiring diagram (the circuit of PC_ON and Power-Status is symbolical):

Wiring diagram external switch and power supply

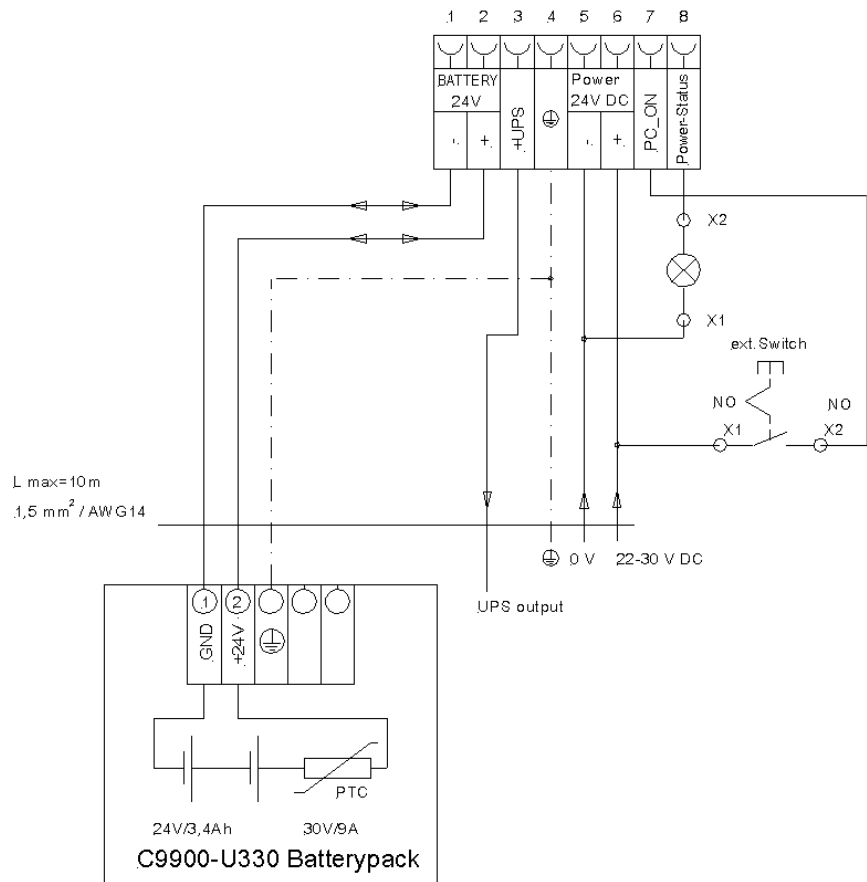

i Note

The battery pack can only be connected when the Industrial PC is provided with an integrated UPS (order option).

Connecting devices



Warning

The power supply plug must be withdrawn!

Please read the documentation for the external devices prior to connecting them.

During thunderstorms, plug connector must neither be inserted nor removed.

When disconnecting a plug connector, always handle it at the plug. Do not pull the cable!

Connecting cables

The connections are located at the top of the Industrial PC and are documented in the product description chapter.

When connecting the cables to the Industrial PC, proceed according to the following sequence:

- Switch off all the devices that are to be connected.
- Disconnect all the devices that are to be connected from the power supply.
- Connect all the cables between the Industrial PC and to the devices that are to be connected.
- Connect all data transfer cables (if present) to the appropriate plug-in receptacles of the data/telecommunication networks.
- Reconnect all devices to the power supply.

Check voltage rating and connect

Fitted with the 24 V_{DC} power supply unit:

1. Check that the external power supply is providing the correct voltage.
2. Insert the power supply cable that you have assembled into the Industrial PC's power supply socket. Then connect it to your external 24 V power supply.



Warning

If a 24 V UPS is installed, the same type of rechargeable battery must be used.

Fastening the cables

Fastening the cables

The connecting cables of the Industrial PC can be fastened with lacing cords. Therefore the pictured clips are mounted at the housing (see arrow).

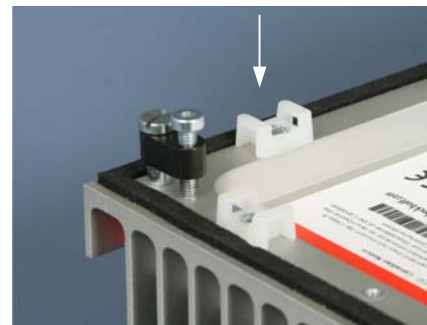

Operating Instructions

Please also refer to chapter [General Notes](#).

Switching the Industrial PC on and off

Switch on

The Industrial PC does not have its own mains switch. The Industrial PC will start when the equipment is switched on, or when it is connected to the power supply.

Shutting down and switching off

When the plant is switched off, or when it is disconnected from its power supply, the Industrial PC will be switched off.

Control software such as is typically used on Industrial PCs permits various users to be given different rights. A user who may not close software may also not switch the Industrial PC off, since data can be lost from the hard disk by switching off while software is running.



Warning

First shut down, then switch off the PC!

If the Industrial PC is switched off as the software is writing a file to the hard disk, the file will be destroyed. Control software typically writes something to the hard disk every few seconds, so that the probability of causing damage by switching off while the software is running is very high.



Warning

When you have shut down the Industrial PC, you have to switch off power supply for at least 10 seconds before rebooting the system. After resetting power supply the PC will start booting automatically.

First switching on and driver installation

When you switch on the Industrial PC for the first time, the pre-installed operating system (optional) will be started. In this case, all the required drivers for any additional, optional hardware components ordered with the PC will already have been installed.

If the PC was ordered without operating system, you have to install the operating system and the driver software for any auxiliary hardware yourself. Please follow the instructions in the documentation for the operating system and the additional devices.

Maintenance

Please also refer to chapter [General Notes](#).



Danger

Cleaning the Industrial PC

Switch off the Industrial PC and all connected devices, and disconnect the Industrial PC from the power supply.

The Industrial PC can be cleaned with a soft, damp cloth. Do not use any aggressive cleaning materials, thinners, scouring material or hard objects that could cause scratches.

Replacing the battery on the motherboard

A used battery on the motherboard has to be replaced according to the rules of the board manufacturer. See also chapter [Product Description](#).



Danger

Danger of Explosion if battery is incorrectly replaced. Replace only with same or equivalent type recommended by the manufacturer. Dispose of used batteries according to the manufacturer's instructions.

Servicing

The Industrial PC requires no maintenance.

Shutting down

Disposal

Dismantling the Industrial PC

The device must be fully dismantled in order to dispose of it. The housing can be sent for metal recycling.

Observe national electronics scrap regulations

Electronic parts such as disk drives and circuit boards must be disposed of in accordance with national electronics scrap regulations.

UPS Software Components (optional)

Installing the UPS driver software

For operating the power supply unit as a UPS, the UPS driver software and the associated UPS driver must be installed on the Industrial PC.

On delivery of the Beckhoff Industrial PC with operating system the software is already installed. Should the software not be installed on your PC, the drivers can be installed from the driver CD provided.

Installation

Installation on the PC

To install the UPS driver software, execute file **Beckhoff_UPS_vx.xx.xx.exe** from the subdirectory of **UPS\...** from the CD provided on the Industrial PC (Driver-archive for the Industrial-PC, C9900-S700-xxxx).

The program is self-extracting and will guide the user through the installation routine.

Beckhoff Information System

Help files

The driver software comes with a detailed help function. The help files can be called up either directly from the configuration register by clicking the Help button, or under via *Start > Programs > Beckhoff > UPS software components*.

Troubleshooting

Please also refer to chapter [General Notes](#).

Fault correction

Fault	Cause	Procedure
Nothing happens after the Industrial PC has been switched on	No power supply to the Industrial PC. Other cause.	Check power supply cable. Call Beckhoff Service.
The Industrial PC does not boot fully	Setup settings are incorrect. Other cause.	Check the setup settings. Call Beckhoff Service.
Computer boots, software starts, but control does not operate correctly	Cause of the fault is either in the software or in parts of the plant outside the Industrial PC.	Call the manufacturer of the machine or the software.
The Industrial PC functions only partially or only part of the time, e.g. no or dark picture, but disk drive responds when switching on	Defective components in the Industrial PC.	Call Beckhoff Service.

Beckhoff Support & Service

Beckhoff and their partners around the world offer comprehensive support and service, guaranteeing fast and competent assistance with all questions related to Beckhoff products and system solutions.

Beckhoff branches and partner companies

Please contact your Beckhoff branch office or partner company for [local support and service](#) on Beckhoff products!

The contact addresses for your country can be found in the list of Beckhoff branches and partner companies: www.beckhoff.com

You will also find further [documentation](#) for Beckhoff components there.

Beckhoff Headquarters

Beckhoff Automation GmbH
Eiserstraße 5
33415 Verl
Germany

Phone: +49(0)5246/963-0
Fax: +49(0)5246/963-198
e-mail: info@beckhoff.com

Beckhoff Support

Beckhoff offers you comprehensive technical assistance, helping you not only with the application of individual Beckhoff products, but also with wide-ranging services:

- worldwide support
- design, programming and commissioning of complex automation systems
- training program for Beckhoff system components

Hotline: +49(0)5246/963-157
Fax: +49(0)5246/963-9157
e-mail: support@beckhoff.com

Beckhoff Service

The Beckhoff service center supports you in all matters of after-sales service:

- on-site service
- repair service
- spare parts service
- hotline service

Hotline: +49(0)5246/963-460
Fax: +49(0)5246/963-479
e-mail: service@beckhoff.com

Quote the project number If servicing is required, please quote the **project number** of your product.

Assembly dimensions



Warning

The assembly of the unit must take place with the orientation diagrammed here.

Industrial PC C6525

All dimensions are in mm.

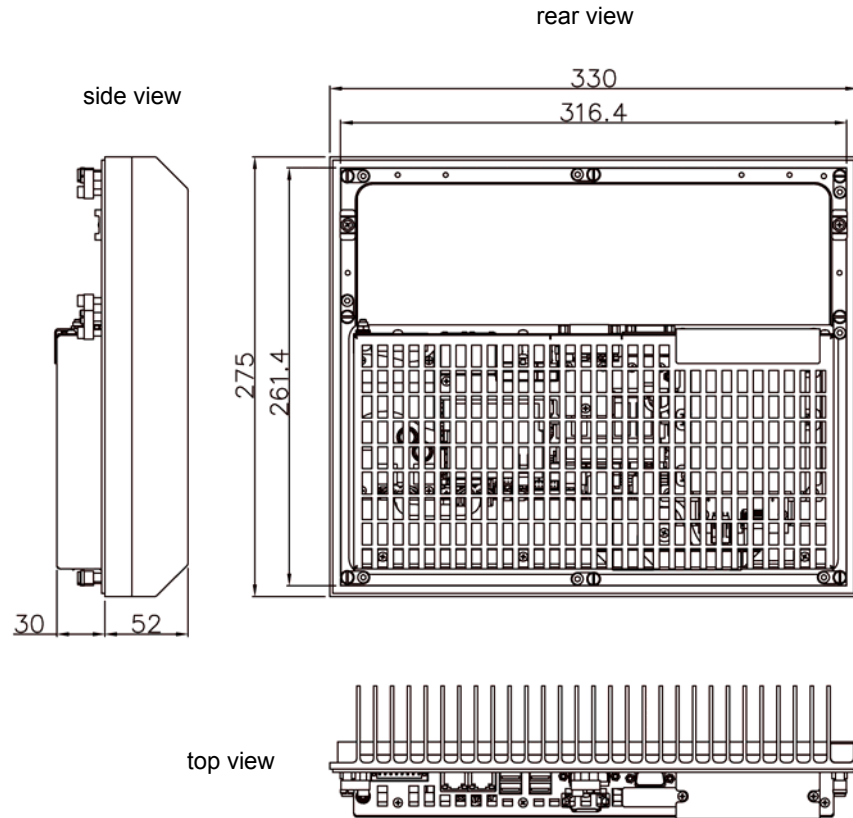

Appendix

Technical data

Industrial PC 6525

Dimensions (W x H x D): 330 x 275 x 82 mm

Weight: 4.74 kg

Do not use the PC in areas of explosive hazard

The Industrial PC may not be used in areas of explosive hazard.

Environmental conditions

The following conditions must be observed during operation:

Ambient temperature: Outside: 0 to 45°C
Inside: 0 to 55°C

Atmospheric humidity: Maximum 95%, non-condensing

Shock resistance

Sinusoidal vibration:
(EN 60068-2-6) 10 to 58 Hz: 0.035 mm
58 to 500 Hz: 0.5 G (~ 5 m/ s²)

Impact:
(EN 60068-2-27/ -29) 5 G (~ 50 m/ s²), duration: 30 ms

Protection class

Protection class: Outside: IP65
Inside: IP20

Power supply
24 V_{DC} power pack

Supply voltage: 22–30V V_{DC}
Power consumption: approx. 90 W (basic configuration)
When operated with UPS: additional 30 W (while charging)
additional 44 W (with UPS-output)

Electromagnetic Compatibility (EMC)

Interference resistance: according to EN 61000-6-2
Emitted resistance: according to EN 61000-6-4

Transport and storage

The same values for atmospheric humidity and shock resistance are to be observed during transport and storage as in operation. The shock resistance during transport can be improved by means of suitably packing the Industrial PC. The ambient temperature during storage and transport must be between -20°C and +65°C.

Approvals

FCC: Federal Communications Commission Radio Frequency Interference Statement

FCC Approval for USA

This equipment has been tested and found to comply with the limits for a Class A digital device, pursuant to Part 15 of the FCC Rules. These limits are designed to provide reasonable protection against harmful interference when the equipment is operated in a commercial environment. This equipment generates, uses, and can radiate radio frequency energy and, if not installed and used in accordance with the instruction manual, may cause harmful interference to radio communications. Operation of this equipment in a residential area is likely to cause harmful interference in which case the user will be required to correct the interference at his own expense.

FCC: Canadian Notice

FCC Approval for Canada

This equipment does not exceed the Class A limits for radiated emissions as described in the Radio Interference Regulations of the Canadian Department of Communications.