



**Documentation**

**KL2602, KL2622**

**Two-channel Relay Output Terminals**

**Version: 2.1.1**  
**Date: 2018-01-12**

**BECKHOFF**



# Table of contents

<b>1 Foreword</b> .....	<b>5</b>
1.1 Notes on the documentation .....	5
1.2 Safety instructions .....	6
1.3 Documentation Issue Status .....	7
<b>2 Product overview</b> .....	<b>8</b>
2.1 Introduction .....	8
2.2 Technical data .....	10
<b>3 Mounting and wiring</b> .....	<b>12</b>
3.1 Installation on mounting rails .....	12
3.2 Connection .....	14
3.2.1 Connection system .....	14
3.2.2 Wiring .....	16
3.3 Connector pin assignment and LEDs .....	18
3.4 ATEX - Special conditions (extended temperature range) .....	21
3.5 ATEX Documentation .....	22
<b>4 Commissioning</b> .....	<b>23</b>
4.1 Remarks for usage of relay terminals .....	23
4.2 Notes on contact-protecting switching of the EL26x2-0010/ KL26x2-0010 terminals .....	24
<b>5 Appendix</b> .....	<b>26</b>
5.1 Support and Service .....	26



# 1 Foreword

## 1.1 Notes on the documentation

### Intended audience

This description is only intended for the use of trained specialists in control and automation engineering who are familiar with the applicable national standards.

It is essential that the documentation and the following notes and explanations are followed when installing and commissioning these components.

It is the duty of the technical personnel to use the documentation published at the respective time of each installation and commissioning.

The responsible staff must ensure that the application or use of the products described satisfy all the requirements for safety, including all the relevant laws, regulations, guidelines and standards.

### Disclaimer

The documentation has been prepared with care. The products described are, however, constantly under development.

We reserve the right to revise and change the documentation at any time and without prior announcement.

No claims for the modification of products that have already been supplied may be made on the basis of the data, diagrams and descriptions in this documentation.

### Trademarks

Beckhoff®, TwinCAT®, EtherCAT®, Safety over EtherCAT®, TwinSAFE®, XFC® and XTS® are registered trademarks of and licensed by Beckhoff Automation GmbH.

Other designations used in this publication may be trademarks whose use by third parties for their own purposes could violate the rights of the owners.

### Patent Pending

The EtherCAT Technology is covered, including but not limited to the following patent applications and patents: EP1590927, EP1789857, DE102004044764, DE102007017835 with corresponding applications or registrations in various other countries.

The TwinCAT Technology is covered, including but not limited to the following patent applications and patents: EP0851348, US6167425 with corresponding applications or registrations in various other countries.

The logo for EtherCAT, featuring the word "EtherCAT" in a bold, sans-serif font. A red arrow points from the top of the "A" towards the right, ending above the "T". A registered trademark symbol (®) is located to the right of the "T".

EtherCAT® is registered trademark and patented technology, licensed by Beckhoff Automation GmbH, Germany

### Copyright

© Beckhoff Automation GmbH & Co. KG, Germany.

The reproduction, distribution and utilization of this document as well as the communication of its contents to others without express authorization are prohibited.

Offenders will be held liable for the payment of damages. All rights reserved in the event of the grant of a patent, utility model or design.

## 1.2 Safety instructions

### Safety regulations

Please note the following safety instructions and explanations!  
Product-specific safety instructions can be found on following pages or in the areas mounting, wiring, commissioning etc.

### Exclusion of liability





All the components are supplied in particular hardware and software configurations appropriate for the application. Modifications to hardware or software configurations other than those described in the documentation are not permitted, and nullify the liability of Beckhoff Automation GmbH & Co. KG.

### Personnel qualification

This description is only intended for trained specialists in control, automation and drive engineering who are familiar with the applicable national standards.

### Description of symbols

In this documentation the following symbols are used with an accompanying safety instruction or note. The safety instructions must be read carefully and followed without fail!

 <b>DANGER</b>	<p><b>Serious risk of injury!</b> Failure to follow the safety instructions associated with this symbol directly endangers the life and health of persons.</p>
 <b>WARNING</b>	<p><b>Risk of injury!</b> Failure to follow the safety instructions associated with this symbol endangers the life and health of persons.</p>
 <b>CAUTION</b>	<p><b>Personal injuries!</b> Failure to follow the safety instructions associated with this symbol can lead to injuries to persons.</p>
 <b>Attention</b>	<p><b>Damage to the environment or devices</b> Failure to follow the instructions associated with this symbol can lead to damage to the environment or equipment.</p>
 <b>Note</b>	<p><b>Tip or pointer</b> This symbol indicates information that contributes to better understanding.</p>

## 1.3 Documentation Issue Status

Version	Comment
2.1.1	<ul style="list-style-type: none"> <li>• Chapter “Notes on contact-protecting switching of the EL26x2-0010/ KL26x2-0010 terminals” updated</li> <li>• Technical data updated</li> </ul>
2.1.0	<ul style="list-style-type: none"> <li>• Chapter “Connection” updated</li> <li>• Technical data updated</li> </ul>
2.0.0	<ul style="list-style-type: none"> <li>• Migration</li> <li>• KL2602-0010 and KL2622-0010 added</li> </ul>
1.4	<ul style="list-style-type: none"> <li>• Technical data updated</li> <li>• Notes about ATEX added</li> </ul>
1.3	<ul style="list-style-type: none"> <li>• Foreword updated</li> <li>• Pictures adapted to LED prism</li> </ul>
1.2	<ul style="list-style-type: none"> <li>• Technical data updated</li> <li>• Foreword and appendix added</li> <li>• English translation available</li> </ul>
1.1	<ul style="list-style-type: none"> <li>• Company name changed to Beckhoff Automation GmbH</li> <li>• Layout updated</li> </ul>
1.0	<ul style="list-style-type: none"> <li>• First release</li> </ul>

### Firmware and hardware versions

The firmware and hardware versions (delivery state) can be taken from the serial number printed on the side of the terminal.

### Syntax of the serial number

Structure of the serial number: WW YY FF HH

WW - week of production (calendar week)

YY - year of production

FF - firmware version

HH - hardware version

Example with ser. no.: 40 15 1A 00:

40 - week of production 40

15 - year of production 2015

1A - firmware version 1A

00 - hardware version 00

## 2 Product overview

### 2.1 Introduction

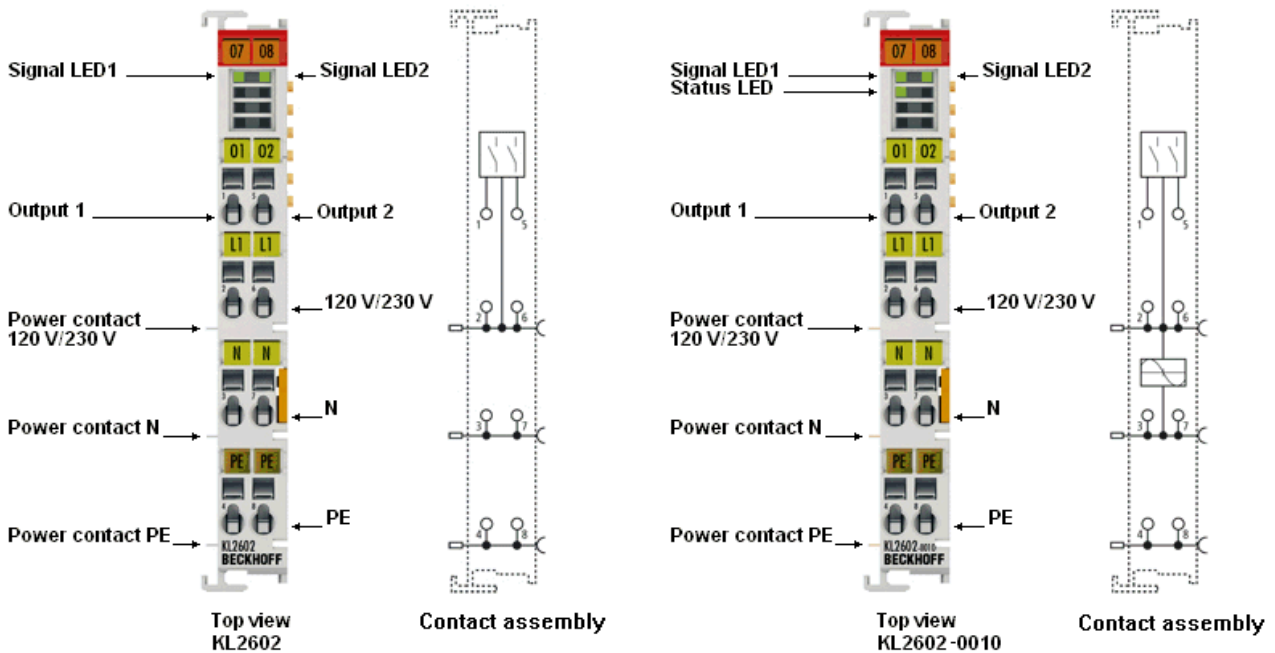

Fig. 1: KL2602, KL2602-0010

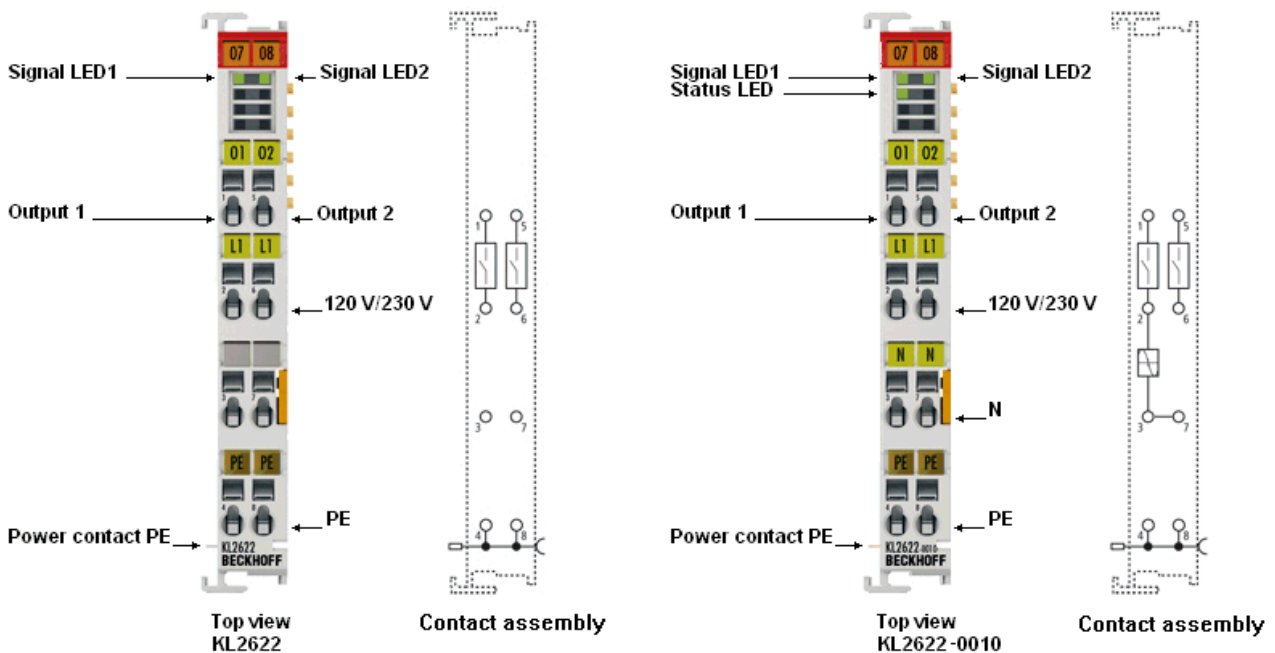

Fig. 2: KL2622, KL2622-0010

The KL2602/ KL2602-0010 (2 x normally open, with power contacts) and KL2622/ KL2622-0010 (2 x normally open) output terminals have two relays each of which has a single contact. The relay contact of the KL2602/ KL2602-0010 is connected to the power contacts and can be generally used for switching devices requiring mains power. The Bus Terminals indicate their signal state by means of light emitting diodes. The KL2622 and KL2622-0010 Bus Terminals have potential-free contacts. The power contacts L and N are not looped through.



The relay terminals KL2602-0010 and KL2622-0010 are designed for soft switching in the range of zero voltage crossing to protect the contacts and is particularly suitable for capacitive loads such as LED lamps (or their chokes).

**Watchdogtimer-Overflow**

If no process data is transferred to the terminal from the Bus Coupler for 100 ms, the green LEDs go out, and the relay contacts are opened after typical reaction time.

**Process data**

The bit-width in the process image is 2 bits.

## 2.2 Technical data

### KL2602-0000 and KL2622-0000

Technical data	KL2602-0000	KL2622-0000
Number of outputs	2 N/O contacts for power contact	2 N/O contacts
Contact material	AgCdO	
Switching voltage	max. 250 V <sub>AC</sub> / 30 V <sub>DC</sub>	
Switching current	Max. 5A	
Switching capacity max. with resistive load	Alternating voltage: 5 A 250 V <sub>AC</sub> 1250 V <sub>AC</sub> Direct voltage: 5 A 30 V <sub>DC</sub> 150 W	
Maximum switching current with inductive load, cosφ=0.4, L/R=7ms	2 A 250 V <sub>AC</sub> 2 A 30 V <sub>DC</sub>	
Minimum permitted load (approximate)	10 mA at 5 V <sub>DC</sub> (as supplied) 100 mA at 5 V <sub>DC</sub> (after a current of approx. 100 mA (or greater) has been switched at least once)	
Reaction time at a rated load	Reaction time: max. 10 ms Release time: max. 4 ms Bounce time: max. 5 ms	
Electrical isolation	500 V (K-Bus / f mains voltage)	
K-Bus current consumption	80 mA	85 mA
Bit width in process image	2 outputs	
Service life Mechanical operating cycles	20,000,000 switching operations	
Service life Electrical operating cycles	At least 100,000 switching operations on resistive loads at 250 V <sub>AC</sub> 5 A or 30 V <sub>DC</sub> 5 A	
Permitted switching frequency at maximum contact load	10 switching operations / minute	
Contact resistance max. (new)	< 30 mΩ	
Insulation resistance (min).	100 MΩ at 500 V <sub>DC</sub>	
Test voltage between open contacts	750 V (1 minute between open contacts)	
Configuration	no address or configuration settings	
Weight	approx. 85 g	approx. 80 g
Dimensions (W x H x D)	approx. 15 mm x 100 mm x 70 mm (width aligned: 12 mm)	
Mounting	on 35 mm mounting rail according to EN 60715	
Permissible ambient temperature range during operation	-25°C...+55°C	
Permissible ambient temperature range during storage	-40°C ... +85°C	
Permissible relative humidity	95 %, no condensation	
Vibration/shock resistance	conforms to EN 60068-2-6/EN 60068-2-27	
EMC immunity/emission	conforms to EN 61000-6-2/EN 61000-6-4	
Installation position	Variable	
Protect. class	IP 20	
Approvals	CE, cULus, ATEX [▶ 22], GL	

**KL2602-0010 and KL2622-0010**

Technical data	KL2602-0010	KL2622-0010
Number of outputs	2 x make contacts for power contact	2 x make contacts
Contact material	Ag-Alloy (Au plating applied to stationary contact)	
Rated load voltage	230 V <sub>AC</sub> / 30 V <sub>DC</sub>	
Load type	ohmic, inductive, capacitive	
Switching current max.	typ. 5 A AC/DC each channel	
Switching current inductive	typ. 2 A AC/DC each channel	
Minimal permissible load	typ. 0.1 mA at 0.1 V <sub>DC</sub>	
Electrical isolation	500 V (K-bus/field potential)	
K-Bus current consumption	80 mA	85 mA
Bit width in the process image	2 outputs	
Reaction time at a rated load	max. 20 ms (= 10 ms zero crossing voltage delay at 50 Hz + 10 ms delay time of the relay)	
Operating cycles mech. (min.)	2 x 10 <sup>7</sup> (at 18 x 10 <sup>3</sup> switching cycles per hour)	
Operating cycles electr. (min.)	100,000 (3 A at 250 V <sub>AC</sub> , 3 A at 30 V <sub>DC</sub> and ohmic load) 80,000 (5 A at 250 V <sub>AC</sub> , 5 A at 30 V <sub>DC</sub> and ohmic load) 100,000 (2 A at 250 V <sub>AC</sub> , 2 A at 30 V <sub>DC</sub> and inductive load)	
Configuration	no address or configuration settings	
Special features	Soft switching at the zero voltage crossing	
Contact resistance (max.)	typ. 100 mΩ	
Insulation resistance (min.)	typ. 1000 MΩ at 500 V <sub>DC</sub>	
Weight	approx. 50 g	
Permissible ambient temperature range during operation	0...+55 °C	
Permissible ambient temperature range during storage	-25...+85 °C	
Permissible relative humidity	95 %, no condensation	
Mounting	on 35 mm mounting rail according to EN 60715	
Vibration/shock resistance	conforms to EN 60068-2-6/EN 60068-2-27	
EMC immunity/emission	conforms to EN 61000-6-2/EN 61000-6-4	
Installation position	Variable	
Protect. class	IP 20	
Approvals	CE	

## 3 Mounting and wiring

### 3.1 Installation on mounting rails



**WARNING**

#### Risk of electric shock and damage of device!

Bring the bus terminal system into a safe, powered down state before starting installation, disassembly or wiring of the Bus Terminals!

#### Assembly

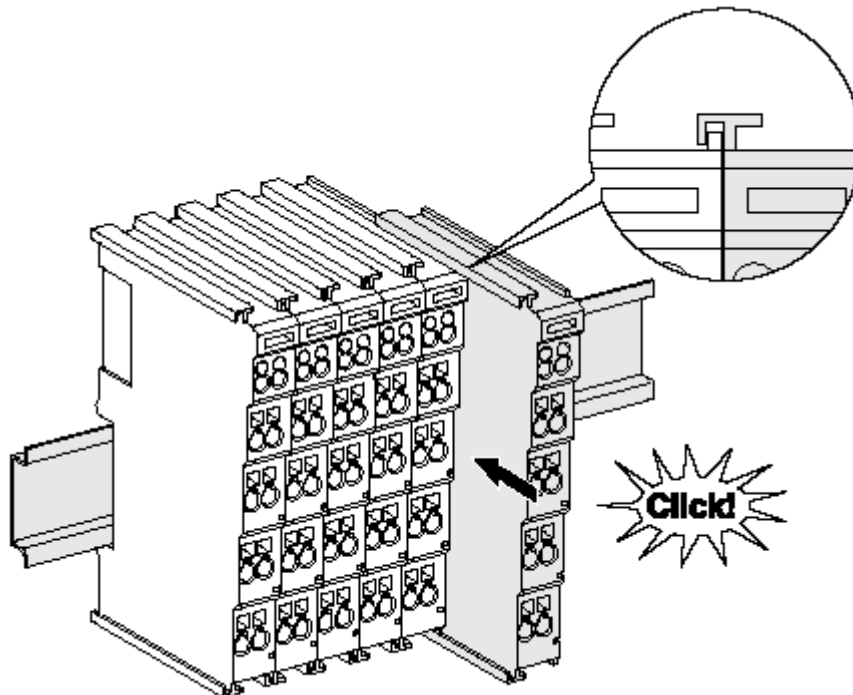

Fig. 3: Attaching on mounting rail

The Bus Coupler and Bus Terminals are attached to commercially available 35 mm mounting rails (DIN rails according to EN 60715) by applying slight pressure:

1. First attach the Fieldbus Coupler to the mounting rail.
2. The Bus Terminals are now attached on the right-hand side of the Fieldbus Coupler. Join the components with tongue and groove and push the terminals against the mounting rail, until the lock clicks onto the mounting rail.

If the Terminals are clipped onto the mounting rail first and then pushed together without tongue and groove, the connection will not be operational! When correctly assembled, no significant gap should be visible between the housings.



**Note**

#### Fixing of mounting rails

The locking mechanism of the terminals and couplers extends to the profile of the mounting rail. At the installation, the locking mechanism of the components must not come into conflict with the fixing bolts of the mounting rail. To mount the mounting rails with a height of 7.5 mm under the terminals and couplers, you should use flat mounting connections (e.g. countersunk screws or blind rivets).

## Disassembly

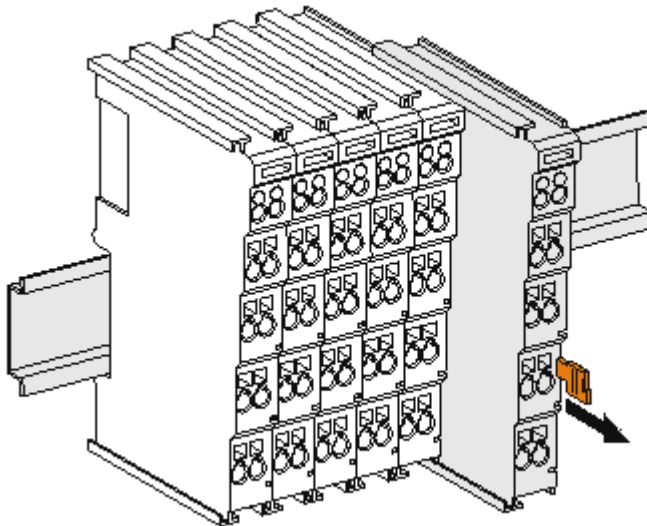

Fig. 4: Disassembling of terminal

Each terminal is secured by a lock on the mounting rail, which must be released for disassembly:

1. Pull the terminal by its orange-colored lugs approximately 1 cm away from the mounting rail. In doing so for this terminal the mounting rail lock is released automatically and you can pull the terminal out of the bus terminal block easily without excessive force.
2. Grasp the released terminal with thumb and index finger simultaneous at the upper and lower grooved housing surfaces and pull the terminal out of the bus terminal block.

## Connections within a bus terminal block

The electric connections between the Bus Coupler and the Bus Terminals are automatically realized by joining the components:

- The six spring contacts of the K-Bus/E-Bus deal with the transfer of the data and the supply of the Bus Terminal electronics.
- The power contacts deal with the supply for the field electronics and thus represent a supply rail within the bus terminal block. The power contacts are supplied via terminals on the Bus Coupler (up to 24 V) or for higher voltages via power feed terminals.



### Note

#### Power Contacts

During the design of a bus terminal block, the pin assignment of the individual Bus Terminals must be taken account of, since some types (e.g. analog Bus Terminals or digital 4-channel Bus Terminals) do not or not fully loop through the power contacts. Power Feed Terminals (KL91xx, KL92xx or EL91xx, EL92xx) interrupt the power contacts and thus represent the start of a new supply rail.

## PE power contact

The power contact labeled PE can be used as a protective earth. For safety reasons this contact mates first when plugging together, and can ground short-circuit currents of up to 125 A.

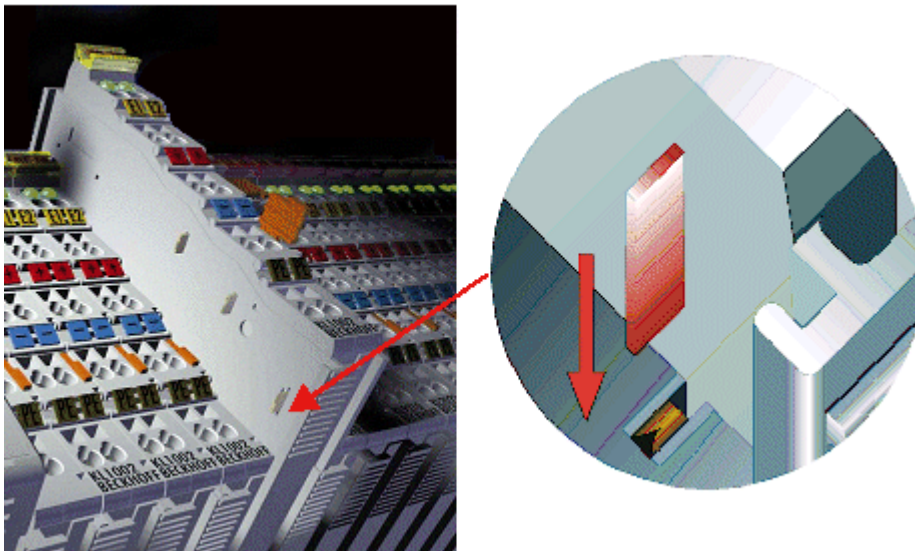

Fig. 5: Power contact on left side

	<b>Possible damage of the device</b>
<b>Attention</b>	<p>Note that, for reasons of electromagnetic compatibility, the PE contacts are capacitatively coupled to the mounting rail. This may lead to incorrect results during insulation testing or to damage on the terminal (e.g. disruptive discharge to the PE line during insulation testing of a consumer with a nominal voltage of 230 V). For insulation testing, disconnect the PE supply line at the Bus Coupler or the Power Feed Terminal! In order to decouple further feed points for testing, these Power Feed Terminals can be released and pulled at least 10 mm from the group of terminals.</p>
	<b>Risk of electric shock!</b>
<b>WARNING</b>	<p>The PE power contact must not be used for other potentials!</p>

## 3.2 Connection

### 3.2.1 Connection system

	<b>Risk of electric shock and damage of device!</b>
<b>WARNING</b>	<p>Bring the bus terminal system into a safe, powered down state before starting installation, disassembly or wiring of the Bus Terminals!</p>

#### Overview

The Bus Terminal system offers different connection options for optimum adaptation to the respective application:

- The terminals of ELxxxx and KLxxxx series with standard wiring include electronics and connection level in a single enclosure.
- The terminals of ESxxxx and KSxxxx series feature a pluggable connection level and enable steady wiring while replacing.
- The High Density Terminals (HD Terminals) include electronics and connection level in a single enclosure and have advanced packaging density.

### Standard wiring (ELxxxx / KLxxxx)

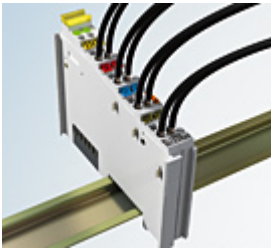

Fig. 6: Standard wiring

The terminals of ELxxxx and KLxxxx series have been tried and tested for years. They feature integrated screwless spring force technology for fast and simple assembly.

### Pluggable wiring (ESxxxx / KSxxxx)



Fig. 7: Pluggable wiring

The terminals of ESxxxx and KSxxxx series feature a pluggable connection level. The assembly and wiring procedure is the same as for the ELxxxx and KLxxxx series. The pluggable connection level enables the complete wiring to be removed as a plug connector from the top of the housing for servicing. The lower section can be removed from the terminal block by pulling the unlocking tab. Insert the new component and plug in the connector with the wiring. This reduces the installation time and eliminates the risk of wires being mixed up.

The familiar dimensions of the terminal only had to be changed slightly. The new connector adds about 3 mm. The maximum height of the terminal remains unchanged.

A tab for strain relief of the cable simplifies assembly in many applications and prevents tangling of individual connection wires when the connector is removed.

Conductor cross sections between 0.08 mm<sup>2</sup> and 2.5 mm<sup>2</sup> can continue to be used with the proven spring force technology.

The overview and nomenclature of the product names for ESxxxx and KSxxxx series has been retained as known from ELxxxx and KLxxxx series.

### High Density Terminals (HD Terminals)



Fig. 8: *High Density Terminals*

The Bus Terminals from these series with 16 terminal points are distinguished by a particularly compact design, as the packaging density is twice as large as that of the standard 12 mm Bus Terminals. Massive conductors and conductors with a wire end sleeve can be inserted directly into the spring loaded terminal point without tools.



Note

### Wiring HD Terminals

The High Density (HD) Terminals of the ELx8xx and KLx8xx series doesn't support plug-gable wiring.

### Ultrasonically "bonded" (ultrasonically welded) conductors



Note

### Ultrasonically "bonded" conductors

It is also possible to connect the Standard and High Density Terminals with ultrasonically "bonded" (ultrasonically welded) conductors. In this case, please note the tables concerning the wire-size width below!

## 3.2.2 Wiring



WARNING

### Risk of electric shock and damage of device!

Bring the bus terminal system into a safe, powered down state before starting installation, disassembly or wiring of the Bus Terminals!

### Terminals for standard wiring ELxxxx/KLxxxx and for pluggable wiring ESxxxx/KSxxxx

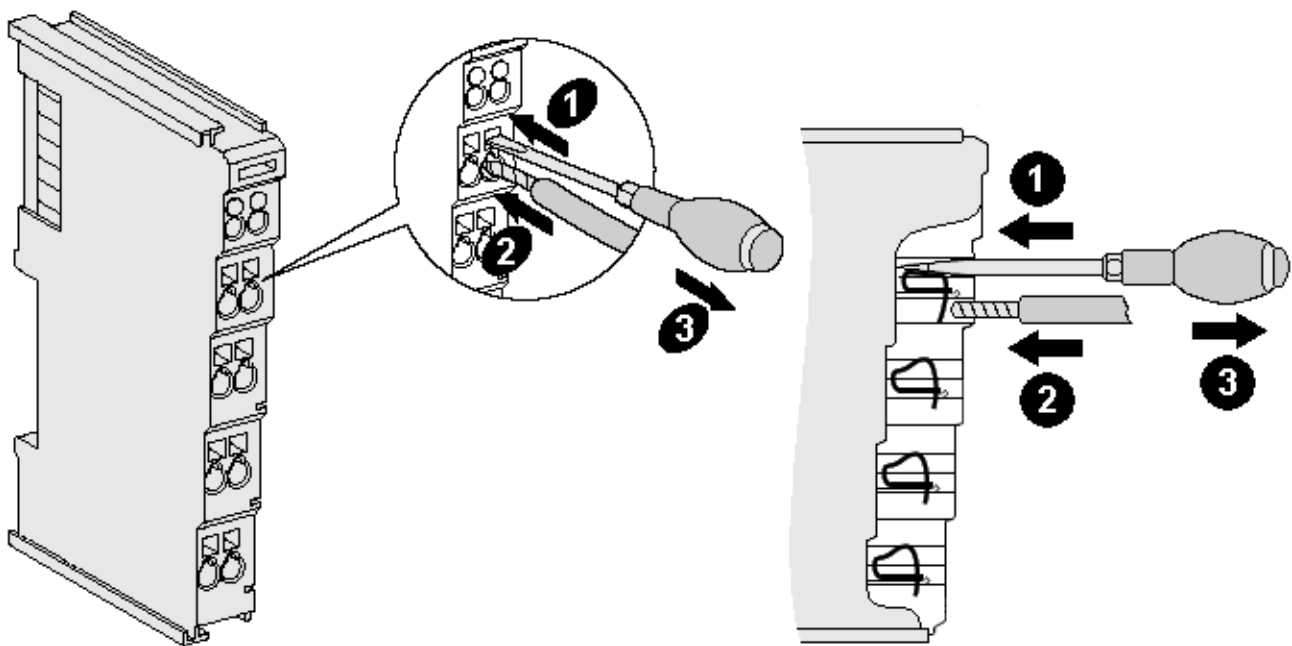

Fig. 9: Connecting a cable on a terminal point

Up to eight terminal points enable the connection of solid or finely stranded cables to the Bus Terminal. The terminal points are implemented in spring force technology. Connect the cables as follows:

1. Open a terminal point by pushing a screwdriver straight against the stop into the square opening above the terminal point. Do not turn the screwdriver or move it alternately (don't toggle).
2. The wire can now be inserted into the round terminal opening without any force.
3. The terminal point closes automatically when the pressure is released, holding the wire securely and permanently.

See the following table for the suitable wire size width.



<b>Terminal housing</b>	<b>ELxxxx, KLxxxx</b>	<b>ESxxxx, KSxxxx</b>
<b>Wire size width (single core wires)</b>	0.08 ... 2.5 mm <sup>2</sup>	0.08 ... 2.5 mm <sup>2</sup>
<b>Wire size width (fine-wire conductors)</b>	0.08 ... 2.5 mm <sup>2</sup>	0,08 ... 2.5 mm <sup>2</sup>
<b>Wire size width (conductors with a wire end sleeve)</b>	0.14 ... 1.5 mm <sup>2</sup>	0.14 ... 1.5 mm <sup>2</sup>
<b>Wire stripping length</b>	8 ... 9 mm	9 ... 10 mm

**High Density Terminals ([HD Terminals \[▶ 15\]](#)) with 16 terminal points**

The conductors of the HD Terminals are connected without tools for single-wire conductors using the direct plug-in technique, i.e. after stripping the wire is simply plugged into the terminal point. The cables are released, as usual, using the contact release with the aid of a screwdriver. See the following table for the suitable wire size width.

<b>Terminal housing</b>	<b>High Density Housing</b>
<b>Wire size width (single core wires)</b>	0.08 ... 1.5 mm <sup>2</sup>
<b>Wire size width (fine-wire conductors)</b>	0.25 ... 1.5 mm <sup>2</sup>
<b>Wire size width (conductors with a wire end sleeve)</b>	0.14 ... 0.75 mm <sup>2</sup>
<b>Wire size width (ultrasonically "bonded" conductors)</b>	only 1.5 mm <sup>2</sup>
<b>Wire stripping length</b>	8 ... 9 mm

### 3.3 Connector pin assignment and LEDs

 <b>CAUTION</b>	<p><b>Risk of injury!</b></p> <p>Bring the bus system into a safe, powered down state before starting installation, disassembly or wiring of the Bus Terminals!</p>
---	---

 <b>Attention</b>	<p><b>Possible damage of devices!</b></p> <p>When designing a Bus Terminal block with different potentials on the power contacts (e.g. 230 V<sub>AC</sub> and 24 V<sub>DC</sub>), please note that it is mandatory to use potential separation terminals*!</p>
---	--

\*e.g.: KL9080

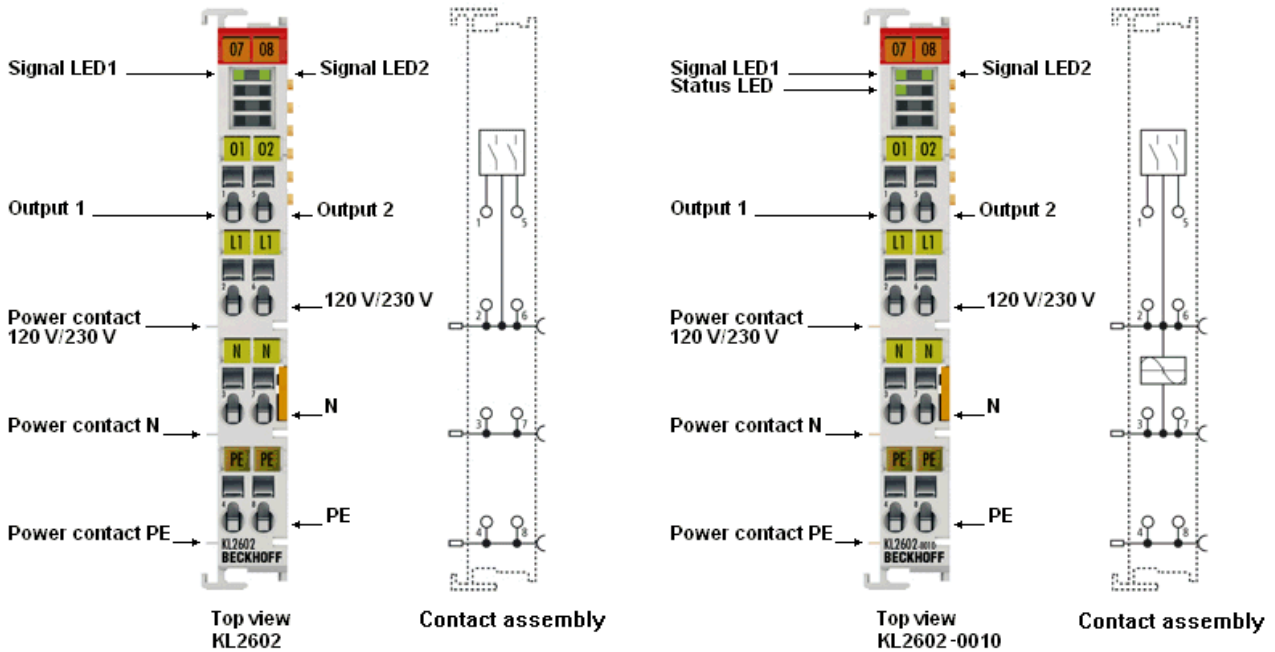

Fig. 10: KL2602-0000 and KL2602-0010

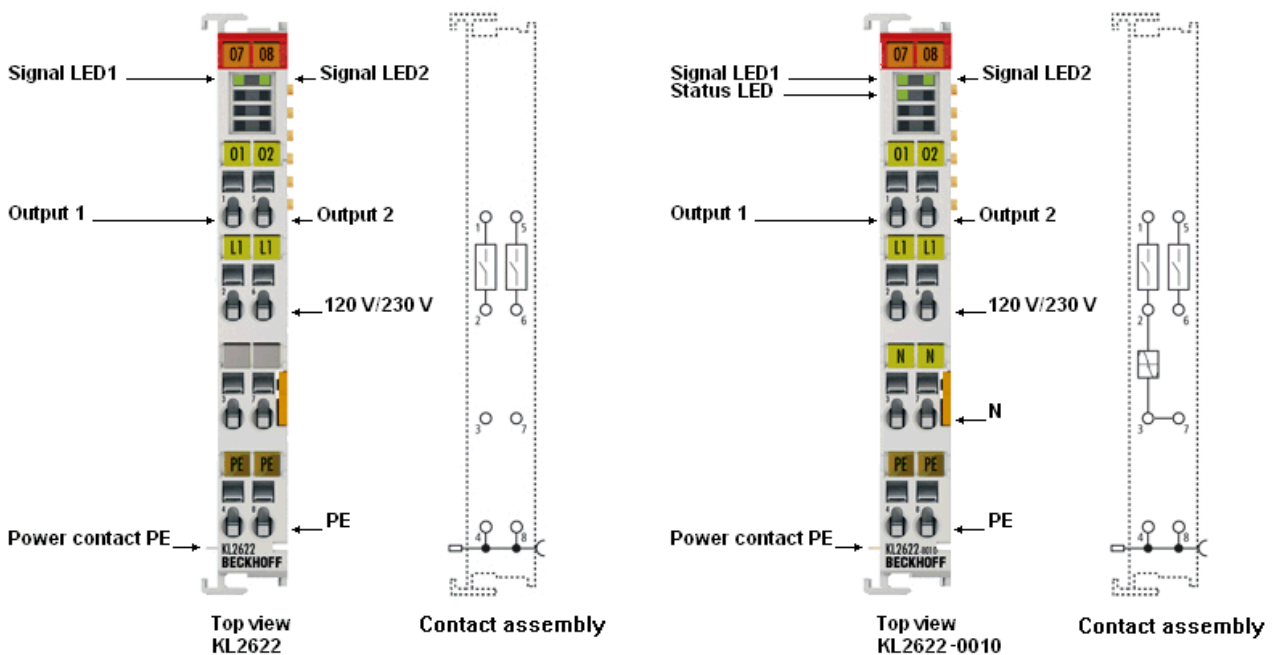

Fig. 11: KL2622-0000 and KL2622-0010

**LEDs**

LED	Color	State	Terminal	Meaning
Signal 1, Signal 2	green	off	KL2602-0000, KL2602-0010	No voltage on output 1 and output 2 respectively
			KL2622-0000, KL2622-0010	Contacts 1-2 (Channel 1) and 5-6 respectively (Channel 2) not connected i.e. no voltage on output 1 and output 2 respectively
		on	KL2602-0000, KL2602-0010	Output voltage ( $\leq 230 V_{AC}$ or $\leq 30 V_{DC}$ ) on output 1 and output 2 respectively
			KL2622-0000, KL2622-0010	Contacts 1-2 (Channel 1) and 5-6 respectively (Channel 2) connected i.e. output voltage ( $\leq 230 V_{AC}$ or $\leq 30 V_{DC}$ ) on output 1 and output 2 respectively
Status*	green	off	KL2602-0010, KL2622-0010	Terminal not synchronized (relay switches without delay e.g. by DC supply)
		on		Terminal is synchronized on mains frequency

\*KL26xx-0010 only

**Pin assignment KL2602-0000, KL2602-0010**

Terminal point		Description
Name	No.	
01	1	Output 1 (relay)
L1	2	120 / 230 V <sub>AC</sub> (internal connected with terminal point 6 and L power contact)
N	3	Neutral line (internal connected with terminal point 7 and N power contact)
PE	4	PE (internal connected with terminal point 8 and PE power contact)
02	5	Output 2 (relay)
L1	6	120 / 230 V <sub>AC</sub> (internal connected with terminal point 2 and L power contact)
N	7	Neutral line (internal connected with terminal point 3 and N power contact)
PE	8	PE (internal connected with terminal point 4 and PE power contact)

**Pin assignment KL2622-0000**

Terminal point		Description
Name	No.	
01	1	Output 1 (relay)
L1	2	120 / 230 V <sub>AC</sub>
-	3	not connected
PE	4	PE (internal connected with terminal point 8 and PE power contact)
02	5	Output 2 (relay)
L1	6	120 / 230 V <sub>AC</sub>
-	7	not connected
PE	8	PE (internal connected with terminal point 4 and PE power contact)

**Pin assignment KL2622-0010**

Terminal point		Description
Name	No.	
O1	1	Output 1 (relay)
L1	2	120 / 230 V <sub>AC</sub>
N	3	Neutral line (internal connected with terminal point 7)
PE	4	PE (internal connected with terminal point 8 and PE power contact)
O2	5	Output 2 (relay)
L1	6	120 / 230 V <sub>AC</sub>
N	7	Neutral line (internal connected with terminal point 3)
PE	8	PE (internal connected with terminal point 4 and PE power contact)

### 3.4 ATEX - Special conditions (extended temperature range)

 <b>WARNING</b>	<p><b>Observe the special conditions for the intended use of Beckhoff fieldbus components with extended temperature range (ET) in potentially explosive areas (directive 94/9/EU)!</b></p> <ul style="list-style-type: none"> <li>• The certified components are to be installed in a suitable housing that guarantees a protection class of at least IP54 in accordance with EN 60529! The environmental conditions during use are thereby to be taken into account!</li> <li>• If the temperatures during rated operation are higher than 70°C at the feed-in points of cables, lines or pipes, or higher than 80°C at the wire branching points, then cables must be selected whose temperature data correspond to the actual measured temperature values!</li> <li>• Observe the permissible ambient temperature range of -25 to 60°C for the use of Beckhoff fieldbus components with extended temperature range (ET) in potentially explosive areas!</li> <li>• Measures must be taken to protect against the rated operating voltage being exceeded by more than 40% due to short-term interference voltages!</li> <li>• The individual terminals may only be unplugged or removed from the Bus Terminal system if the supply voltage has been switched off or if a non-explosive atmosphere is ensured!</li> <li>• The connections of the certified components may only be connected or disconnected if the supply voltage has been switched off or if a non-explosive atmosphere is ensured!</li> <li>• The fuses of the KL92xx/EL92xx power feed terminals may only be exchanged if the supply voltage has been switched off or if a non-explosive atmosphere is ensured!</li> <li>• Address selectors and ID switches may only be adjusted if the supply voltage has been switched off or if a non-explosive atmosphere is ensured!</li> </ul>
---	---

#### Standards

The fundamental health and safety requirements are fulfilled by compliance with the following standards:

- EN 60079-0:2012+A11:2013
- EN 60079-15:2010

#### Marking

The Beckhoff fieldbus components with extended temperature range (ET) certified for potentially explosive areas bear the following marking:



**II 3G KEMA 10ATEX0075 X Ex nA IIC T4 Gc Ta: -25 ... 60°C**

or



**II 3G KEMA 10ATEX0075 X Ex nC IIC T4 Gc Ta: -25 ... 60°C**

## 3.5 ATEX Documentation



### Note

**Notes about operation of the Beckhoff terminal systems in potentially explosive areas (ATEX)**

Pay also attention to the continuative documentation

Notes about operation of the Beckhoff terminal systems in potentially explosive areas (ATEX)

that is available in the download area of the Beckhoff homepage <http://www.beckhoff.com>!

## 4 Commissioning

### 4.1 Remarks for usage of relay terminals



Note

#### Analyze operation conditions

It is extremely important to observe the technical specifications if fault-free operation is to be guaranteed.

Any time that the stated parameters are exceeded, damage ranging from premature contact ageing up to fused contacts can result. If relays are to be used in a control system the expected operating conditions must be analyzed with great care. Switching capacity, service life (operating cycles) and the number of switches per minute must be considered. Appropriate protective circuits must be used to protect the relay contacts from excessive voltage peaks such as can occur when switching inductive loads (contactors, motors etc.). This allows switching frequencies nearly equal to those appropriate to resistive loads to be achieved. Arcing time when switching DC loads are significantly longer than those for comparable AC voltages (zero crossing); material flow can result. If the terminal is used to change the direction of inductive loads, adequate dead-times during the switch-over must be provided, in order to avoid temporary short-circuits.

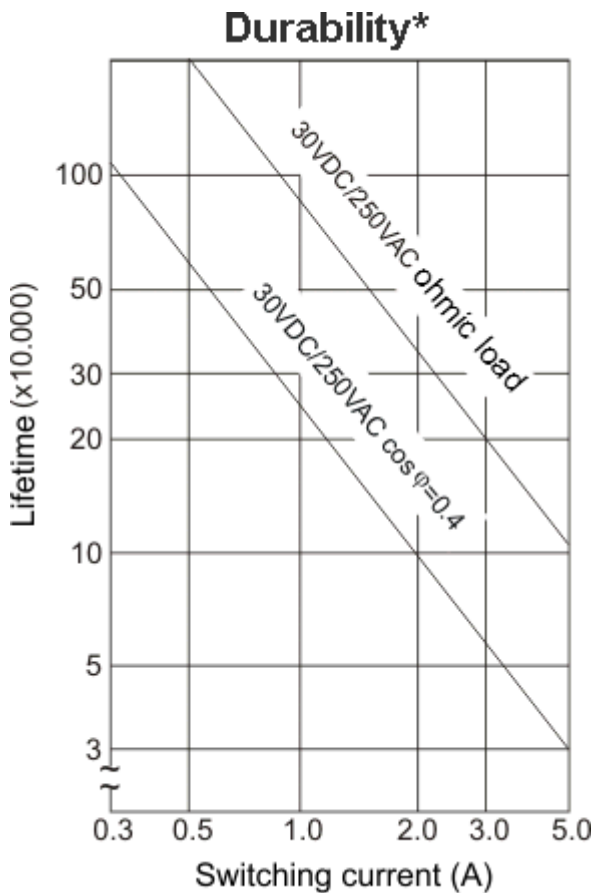

Fig. 12: \*not valid for KL26x2-0010

#### For the -0010 variants applies:

The relays internally of these terminals would be switched near to the zero voltage crossing of an AC supply. Hereby the lifetime of the outputs is no longer dependent by the absolute lifetime of the relay. The result of an exemplary long term test with the following boundary conditions represent that:

- Each channel of a terminal EL2622-0010 (or KL2622-0010 respectively) switches cyclic one time per second a beforehand complete discharged capacitive load of approximately 40 μF (without any additional resistor in series) to 230 V AC, whereof a permanent current of approx. 4 A is resulting.

- After abortion of the test over more than 200,000 switching cycles per channel the expected lifetime of the terminal outputs are above them of the relays.
- Under the same test conditions but without connection of the neutral wire that disables the operation of the zero voltage detection, the relay was out of order after less than 10 switching cycles.



Note

**Economic life-time**

It is the maximum values that are to be expected that are critical to selection of the right terminal rather than the technical figures for normal operation!

## 4.2 Notes on contact-protecting switching of the EL26x2-0010/ KL26x2-0010 terminals

In order to minimize starting currents in the form of capacitive loads in electronic ballasts, it is possible to switch on loads at the time when the mains voltage zero crossing occurs. To this end this Bus Terminal features continuous zero crossing detection for frequencies between 45 Hz and 65 Hz.

At 50 Hz this results in an additional switch on delay to the usual relay delay of 10 ms, at 60 Hz the value is approx. 8.33 ms.



Note

**Operation only possible at the same phase**

No different phases may be applied at terminal points 2 and 6 (400 V voltage between the terminal points is not permitted!).

### General notes on commissioning

- In order to be able to use this function, an alternating voltage for internal detection must be present between terminal points 2 and 3. The feeding in of an alternating voltage can be done via the blade contacts, too.
- Under usual grid conditions the terminal switches near the voltage zero crossing with a typical temporal accuracy of <1 ms.
- If no zero crossings of an alternating voltage occur for a prolonged period, the system responds directly to the switch on or switch off request by the PLC, without delay.
- For the EL versions, it is advisable for the PLC to wait until the status becomes “1”, indicating successful synchronization of the terminal with the zero crossings of the prevailing alternating voltage. The status bit can be linked via the process data of the terminal and evaluated by the PLC.
- If the “detection” voltage between terminal points 2 and 3 is switched off in the meantime, the Bus Terminal is only able to maintain the synchronization for a very short time. Thereafter, it indicates the loss of synchronization by switching off the corresponding status LED or the status bit. A new synchronization process commences once the supply voltage is restored. Subsequently the switching operations of the relay once again take place near the voltage zero crossing.



Note

**Missing synchronization**

If a relay is switched on without synchronization, a current-minimized switch on operation near the alternating voltage zero crossing cannot be guaranteed.



Note

**Mains quality requirements**

If mains voltage as “detection” voltage is used: In the event of mains voltage faults, which jeopardize precise synchronization with the mains voltage zero crossing, suitable mains filters should be used.



**Note****Temperature compensation of the terminal**

The terminal provides an automatic temperature compensation that allows a soft switching in a wide temperature range. However temperature alteration can be compensated by the terminal in a determined dimension only that results by fast alterations to a decreased precision of the zero crossing detection.

## 5 Appendix

### 5.1 Support and Service

Beckhoff and their partners around the world offer comprehensive support and service, making available fast and competent assistance with all questions related to Beckhoff products and system solutions.

#### Beckhoff's branch offices and representatives

Please contact your Beckhoff branch office or representative for [local support and service](#) on Beckhoff products!

The addresses of Beckhoff's branch offices and representatives round the world can be found on her internet pages:

<http://www.beckhoff.com>

You will also find further [documentation](#) for Beckhoff components there.

#### Beckhoff Headquarters

Beckhoff Automation GmbH & Co. KG

Huelshorstweg 20  
33415 Verl  
Germany

Phone:	+49(0)5246/963-0
Fax:	+49(0)5246/963-198
e-mail:	info@beckhoff.com

#### Beckhoff Support

Support offers you comprehensive technical assistance, helping you not only with the application of individual Beckhoff products, but also with other, wide-ranging services:

- support
- design, programming and commissioning of complex automation systems
- and extensive training program for Beckhoff system components

Hotline:	+49(0)5246/963-157
Fax:	+49(0)5246/963-9157
e-mail:	support@beckhoff.com

#### Beckhoff Service

The Beckhoff Service Center supports you in all matters of after-sales service:

- on-site service
- repair service
- spare parts service
- hotline service

Hotline:	+49(0)5246/963-460
Fax:	+49(0)5246/963-479
e-mail:	service@beckhoff.com

## List of illustrations

Fig. 1	KL2602, KL2602-0010 .....	8
Fig. 2	KL2622, KL2622-0010 .....	8
Fig. 3	Attaching on mounting rail .....	12
Fig. 4	Disassembling of terminal.....	13
Fig. 5	Power contact on left side.....	14
Fig. 6	Standard wiring.....	15
Fig. 7	Pluggable wiring .....	15
Fig. 8	High Density Terminals.....	15
Fig. 9	Connecting a cable on a terminal point .....	16
Fig. 10	KL2602-0000 and KL2602-0010.....	18
Fig. 11	KL2622-0000 and KL2622-0010.....	18
Fig. 12	*not valid for KL26x2-0010 .....	23