

front view

left view

rear view

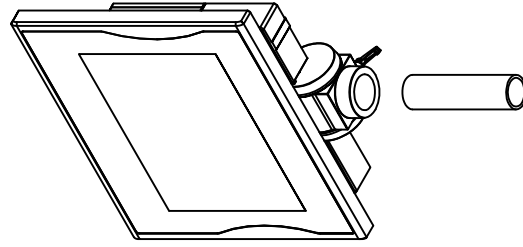

CP7232-0001-M163-E169

Ø48 mm fixingtube

main dimensions and fixing points

dimensions in mm

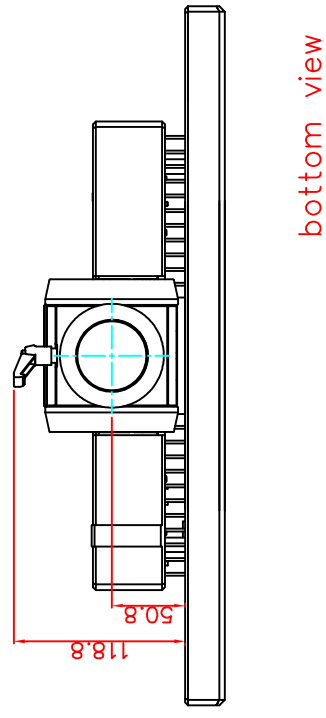

bottom view