

CP7142-0001-M152
mounting arm adapter
for Roltec Tara-48-60
146.025.016

main dimensions and fixing
points
dimensions in mm

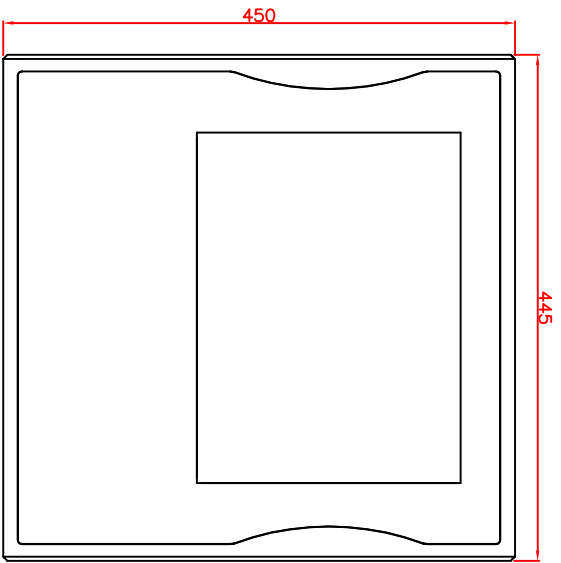

front view

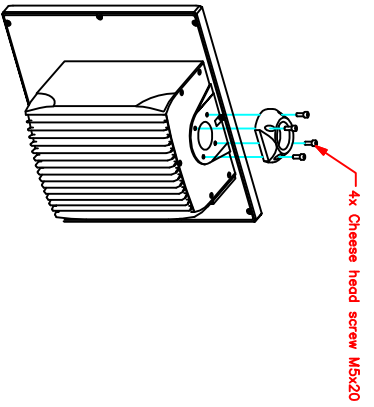
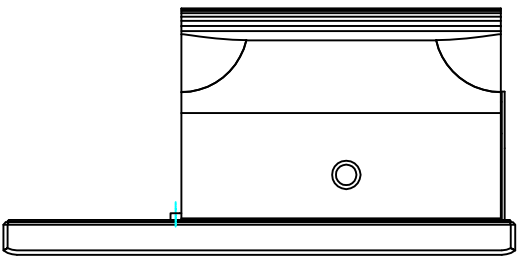

right view

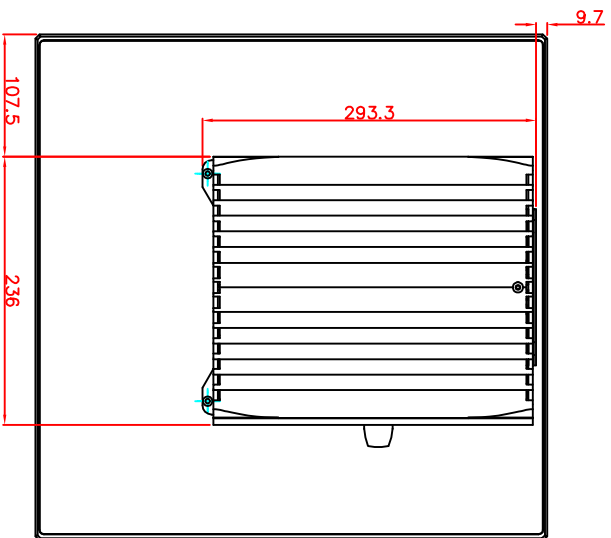

rear view

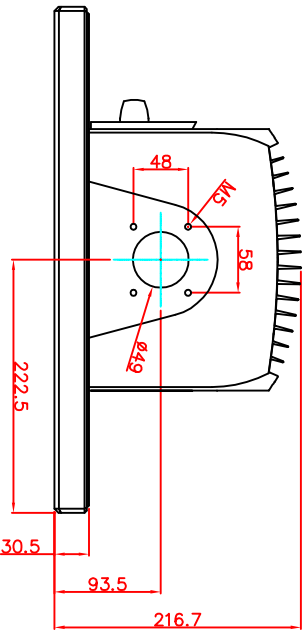

top view