

CP7123-0002-M154
mounting arm adapter
for Roltec Tara-48-60
146.025.016

main dimensions and fixing
points
dimensions in mm

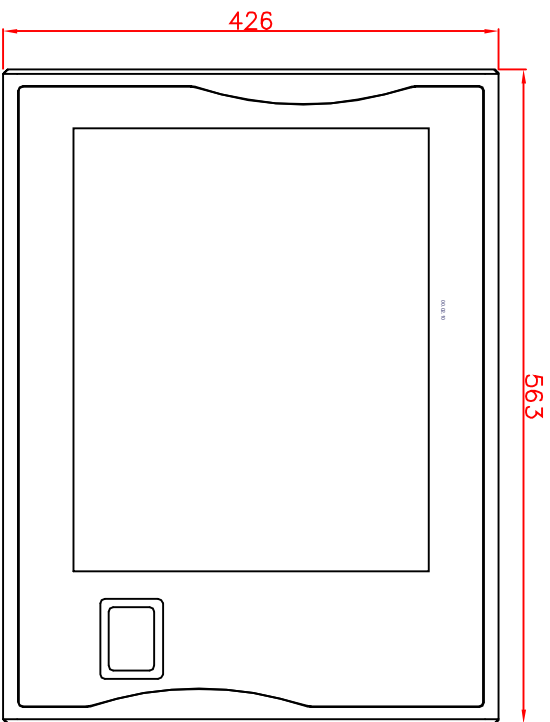

front view

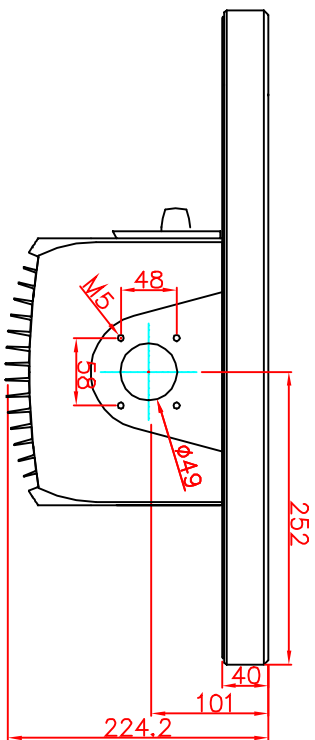
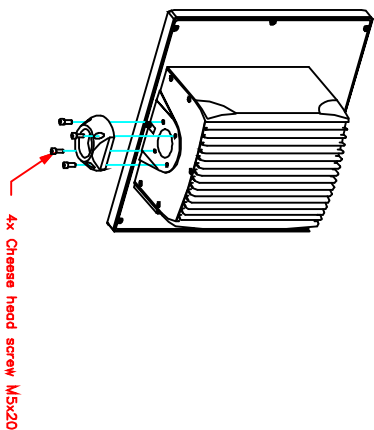
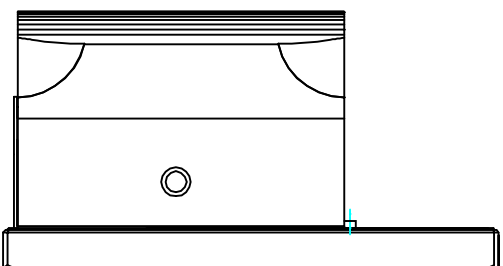

right view

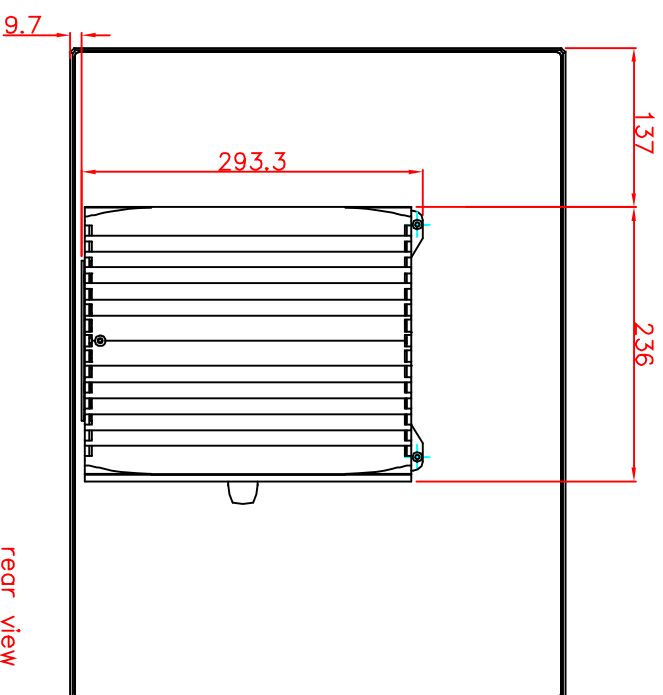

rear view