

CP6712-0001-0040

main dimensions and  
fixing points

dimensions in mm

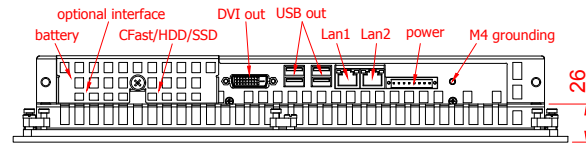

bottom view

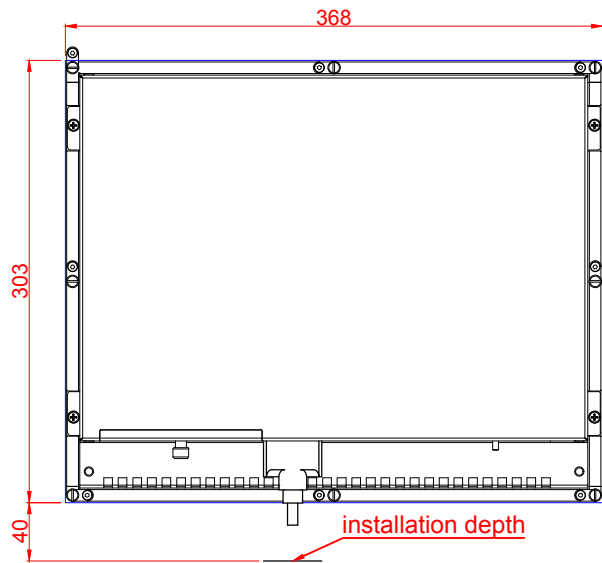

cut out dimensions: 303mm x 368mm

rear view

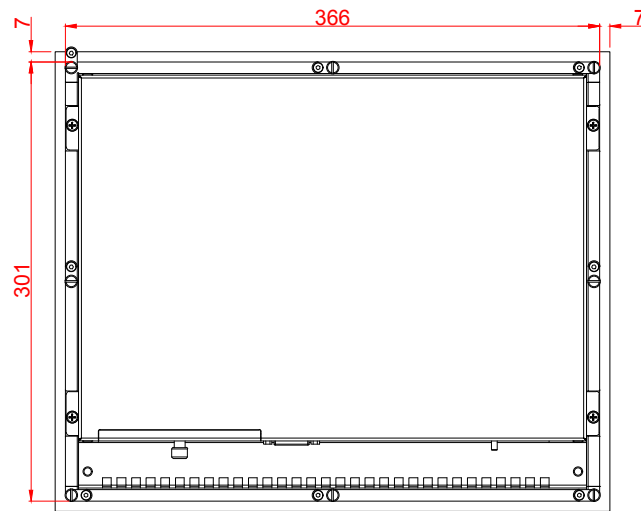

rear view

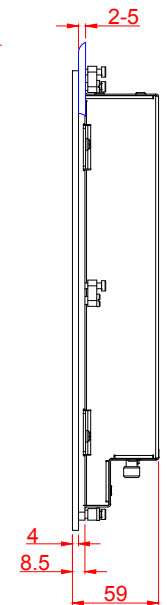

left view

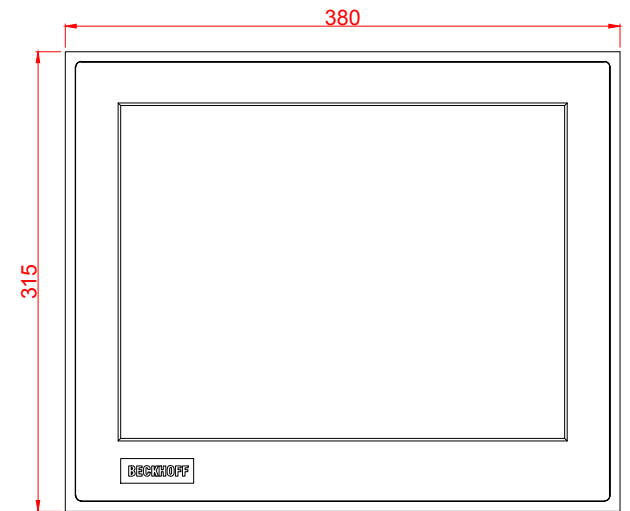

front view