

CP6701-0021-0040

main dimensions and
fixing points

dimensions in mm

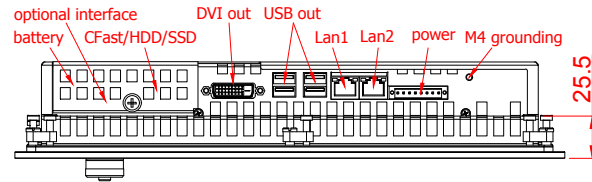

bottom view

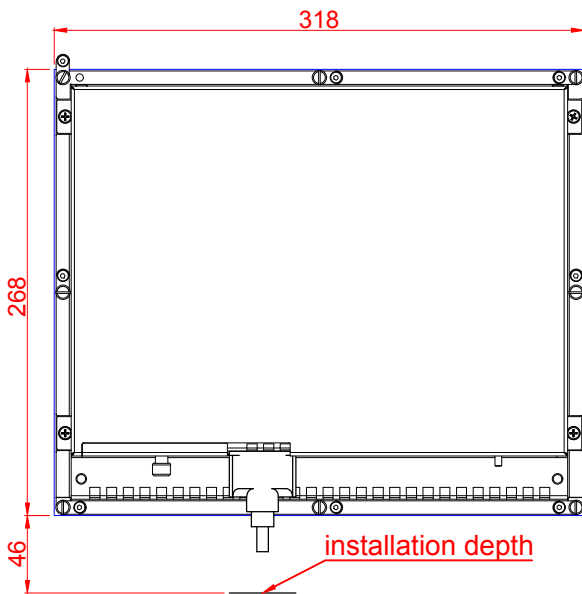

cut out dimensions: 268mm x 318mm

rear view

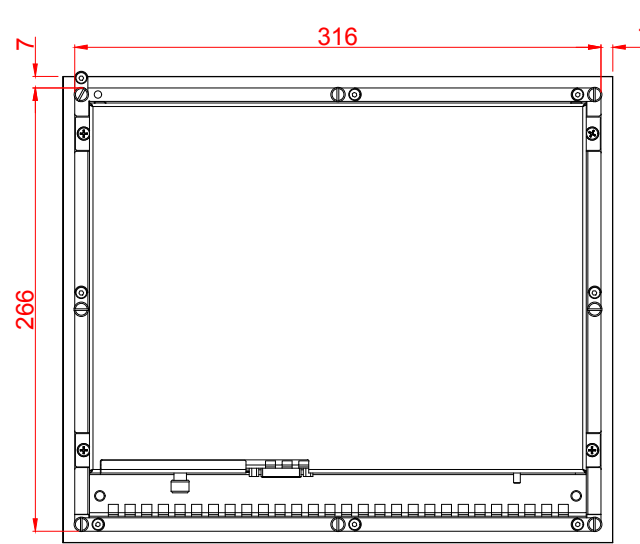

rear view

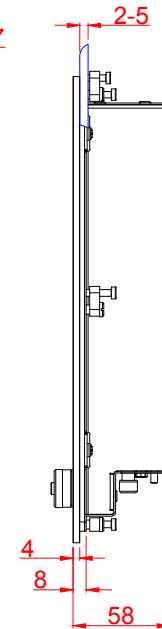

left view

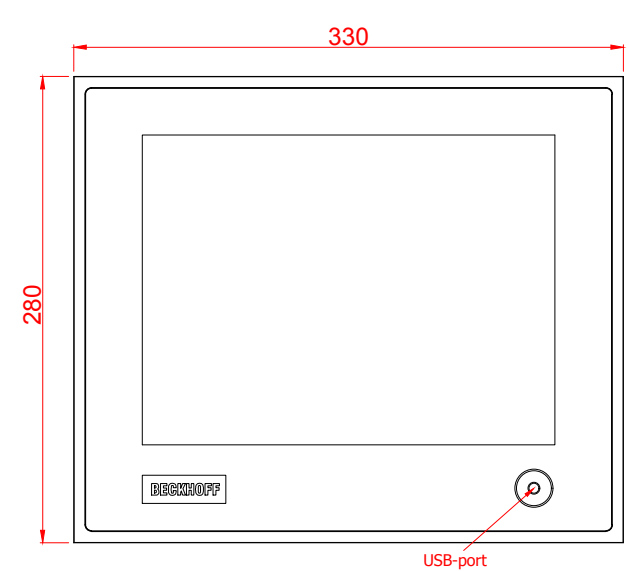

front view