

front view

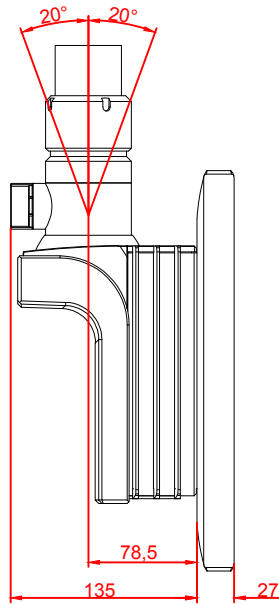

left view

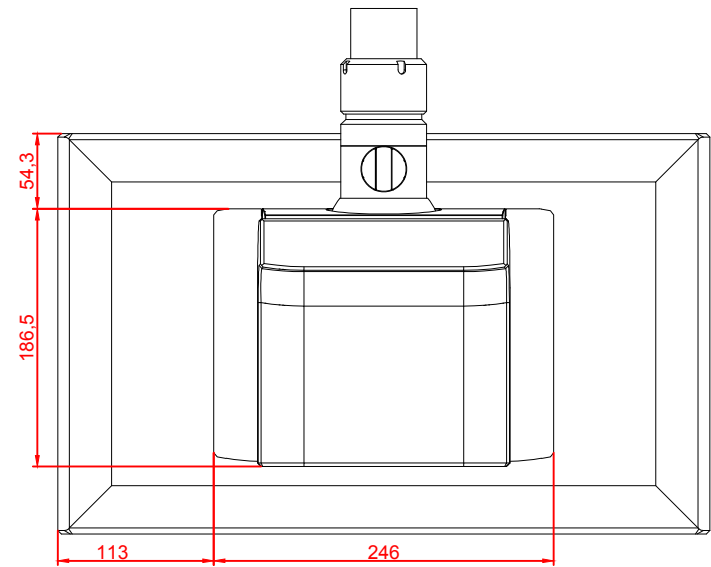

rear view

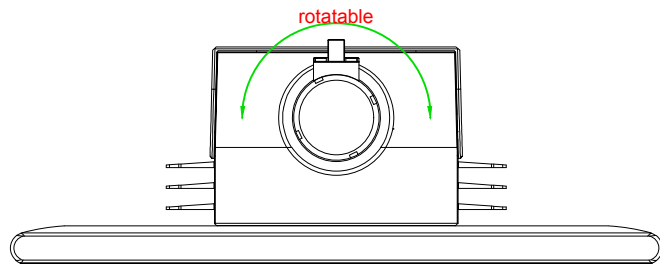

top view

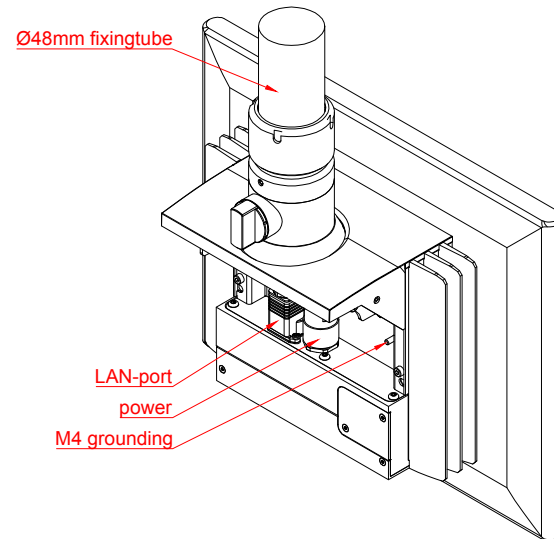

CP3718

main dimensions and
fixing points

dimensions in mm