

front view

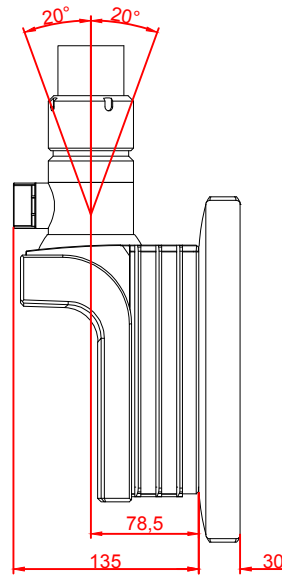

left view

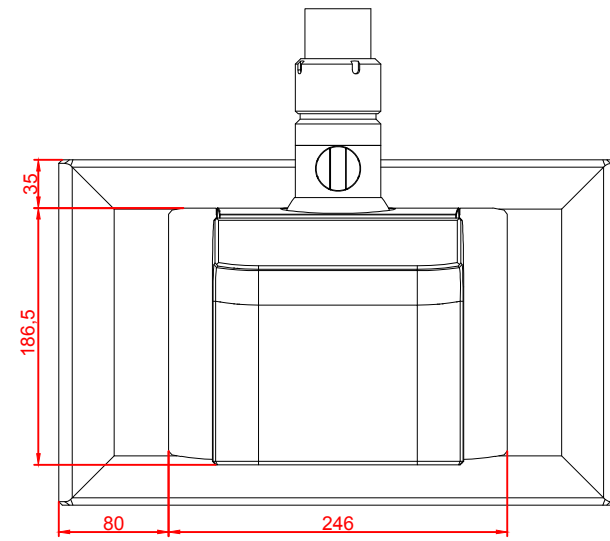

rear view

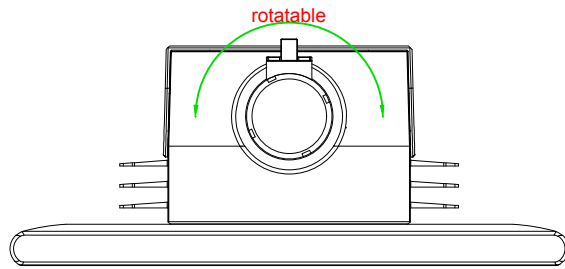

top view

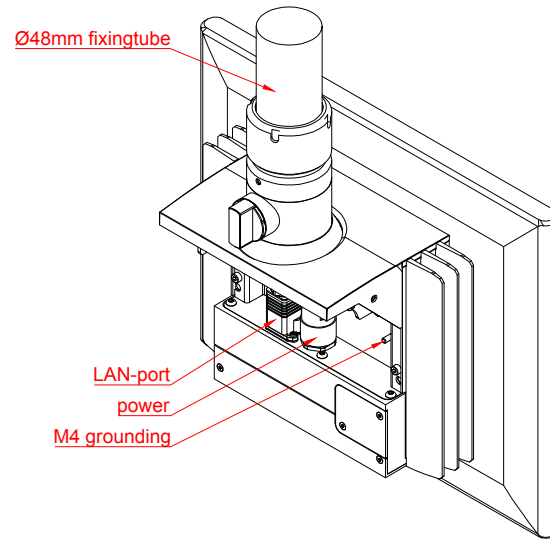

CP3716

main dimensions and
fixing points

dimensions in mm